



US00D613496S

(12) **United States Design Patent**
Waring et al.

(10) **Patent No.:** **US D613,496 S**
(45) **Date of Patent:** **** Apr. 13, 2010**

(54) **VITAMIN VAULT**

(76) Inventors: **William Waring**, P.O. Box 757,
Idyllwild, CA (US) 92548; **Gerald
Solomon**, 13539 W. Figueroa Dr., Sun
City West, AZ (US) 85375

(**) Term: **14 Years**

(21) Appl. No.: **29/340,040**

(22) Filed: **Jul. 13, 2009**

(51) **LOC (9) Cl.** **03-01**

(52) **U.S. Cl.** **D3/203.3**

(58) **Field of Classification Search** D3/203.3,
D3/203.2, 201, 205; D9/730-732; 206/1.5,
206/528-538; D7/589; D6/515
See application file for complete search history.

(56) **References Cited**

U.S. PATENT DOCUMENTS

4,062,445	A	12/1977	Moe
D252,072	S	6/1979	Bridges
4,776,489	A	10/1988	Tarlow et al.
D310,938	S	10/1990	Vigil
5,685,460	A	11/1997	Vlastuin
6,000,546	A	12/1999	Noble

D466,801	S	*	12/2002	Holland	D3/203.3
D528,782	S	*	9/2006	Oas	D3/203.3
7,387,207	B2	*	6/2008	Priebe et al.	206/532
D587,005	S	*	2/2009	Gardner	D3/203.3

* cited by examiner

Primary Examiner—Catherine R Oliver
(74) *Attorney, Agent, or Firm*—Kyle Fletcher

(57) **CLAIM**

The ornamental design for vitamin vault, as shown and described.

DESCRIPTION

FIG. 1 is a front elevational view of the vitamin vault showing our new design, with the words vita vault being shown in broken lines. The broken lines being for illustrative purposes only and forming no part of the claimed design.

FIG. 2 is a rear view thereof;

FIG. 3 is a side view thereof;

FIG. 4 is a bottom plan view thereof;

FIG. 5 is a top plan view thereof; and,

FIG. 6 is a perspective view.

1 Claim, 5 Drawing Sheets

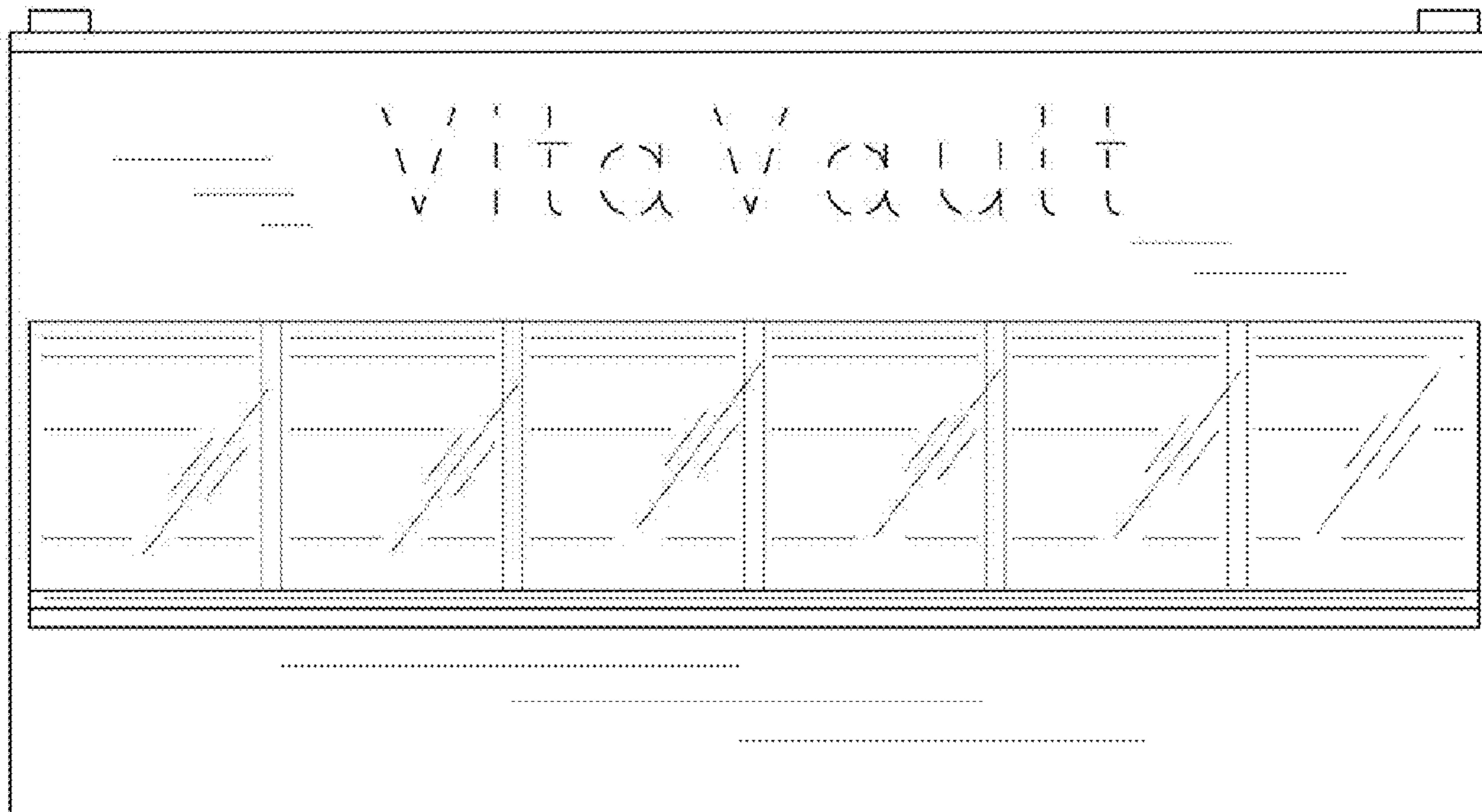

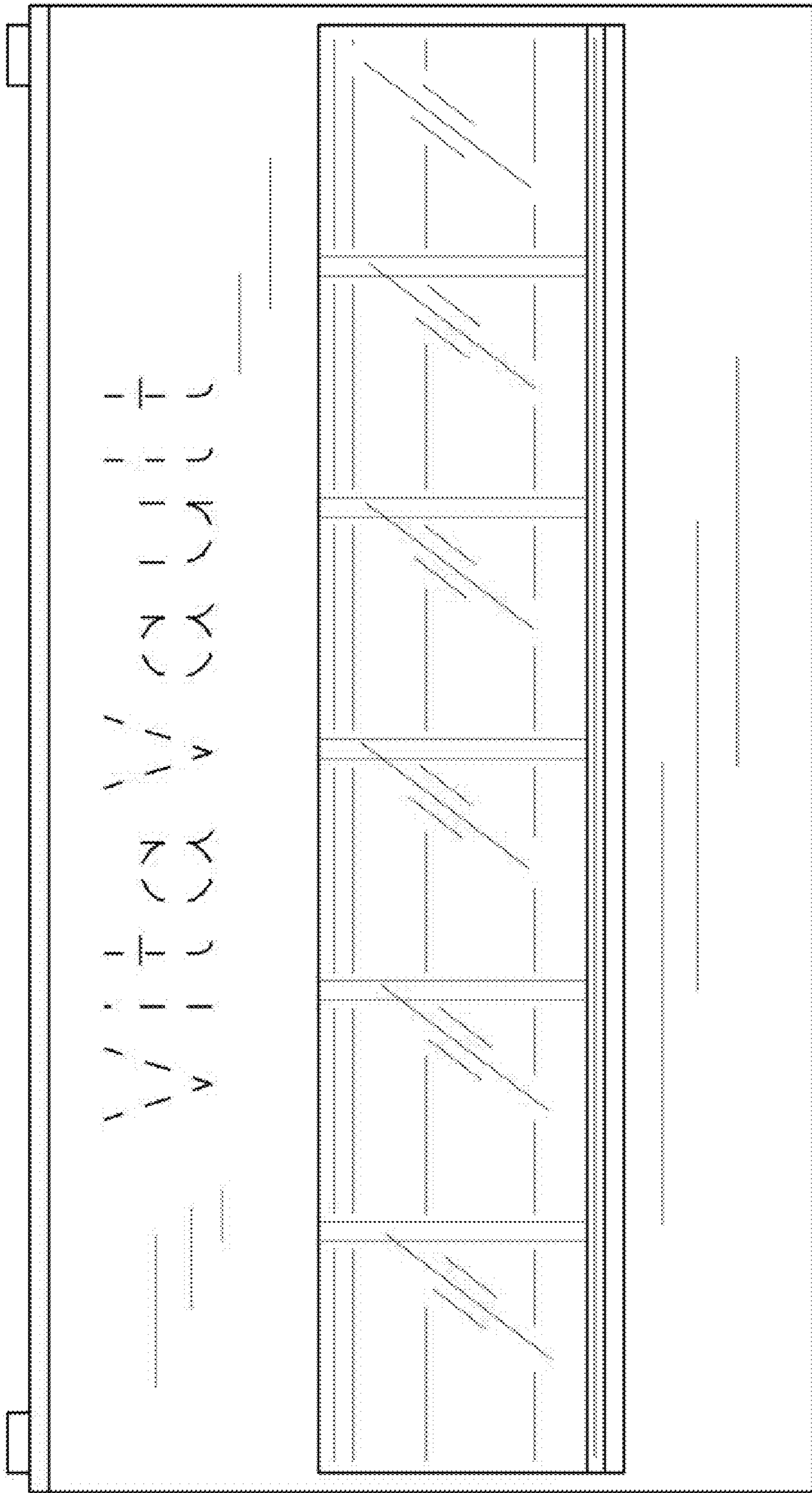

FIG. 1

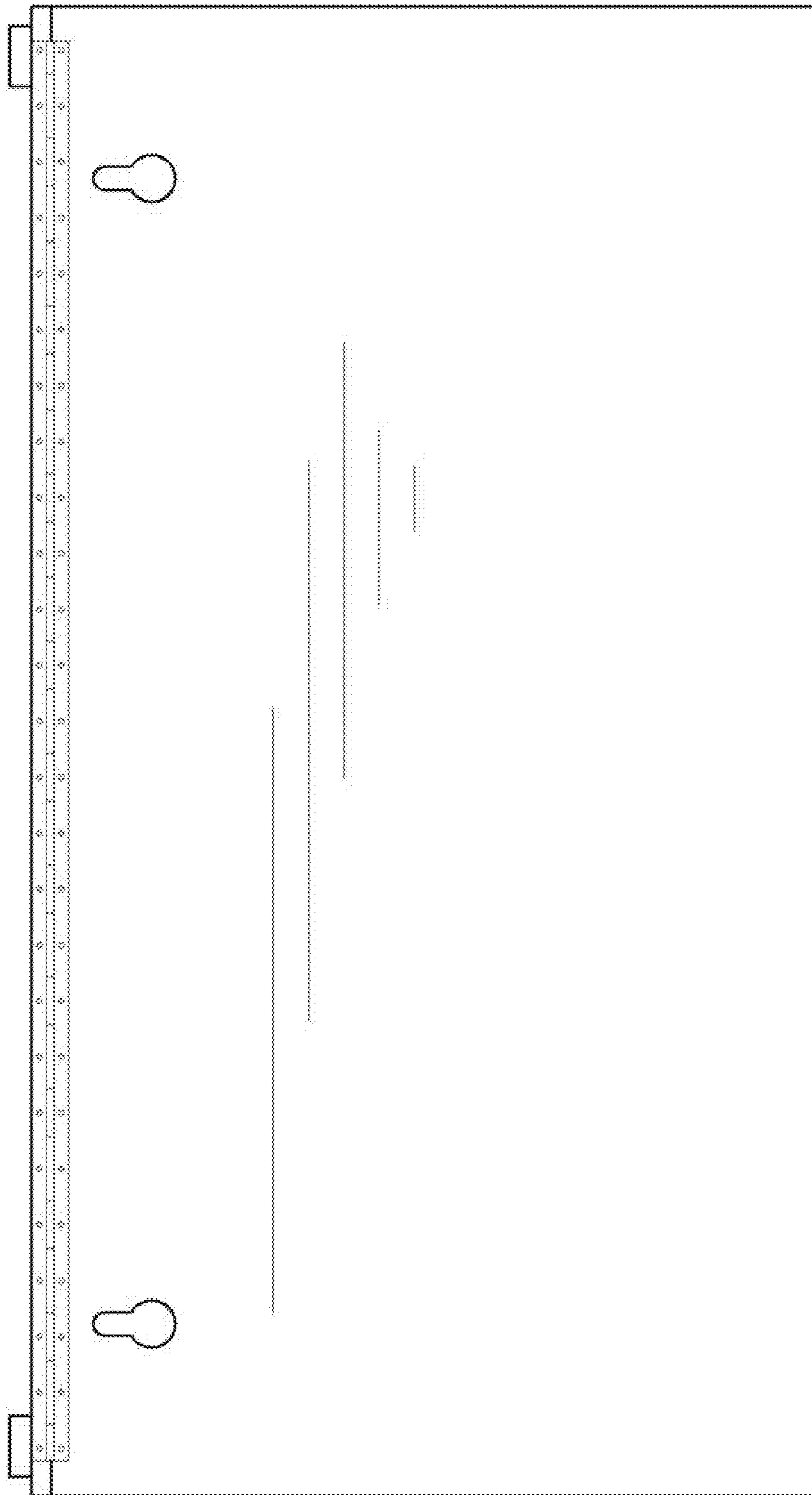

FIG. 2

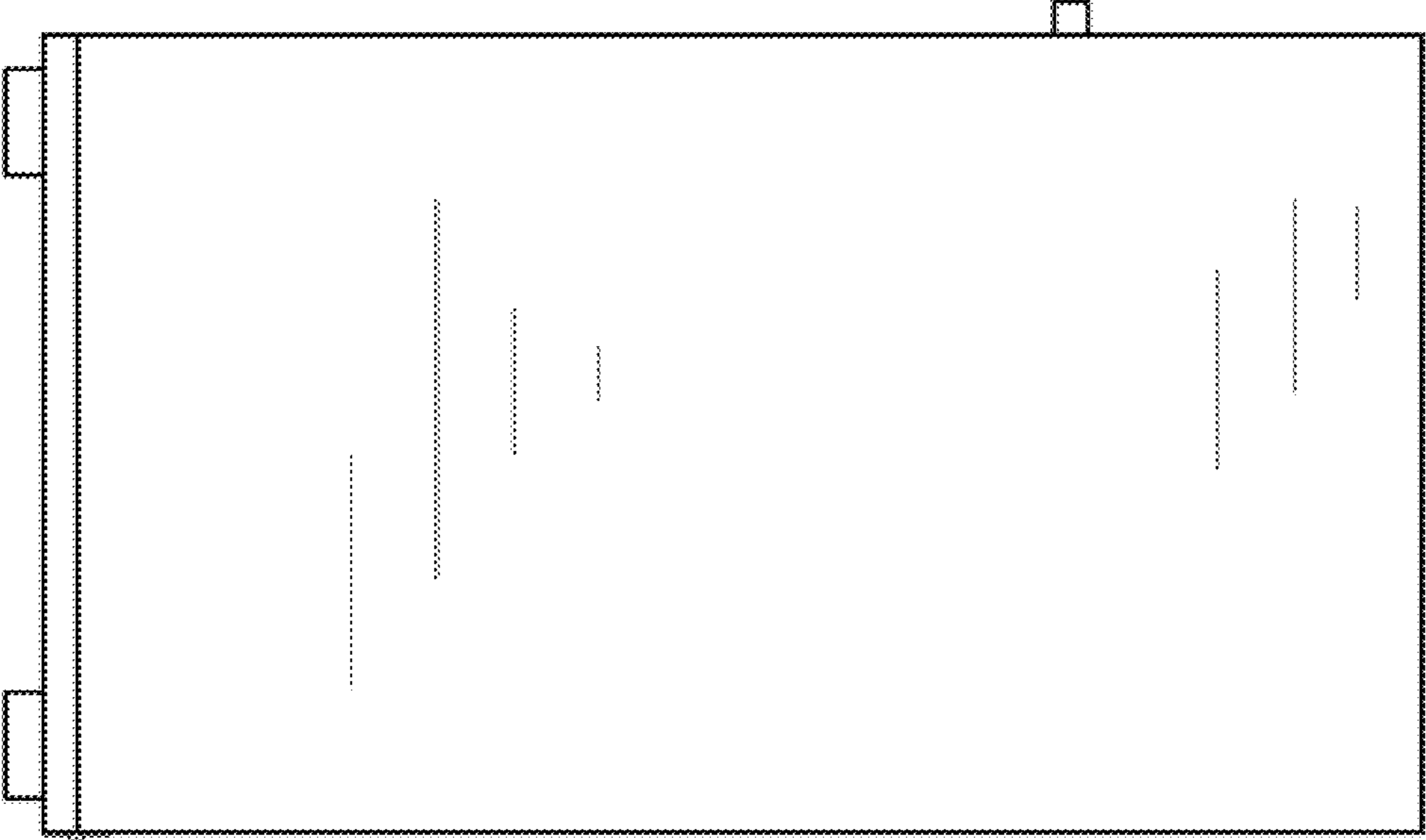

FIG. 3

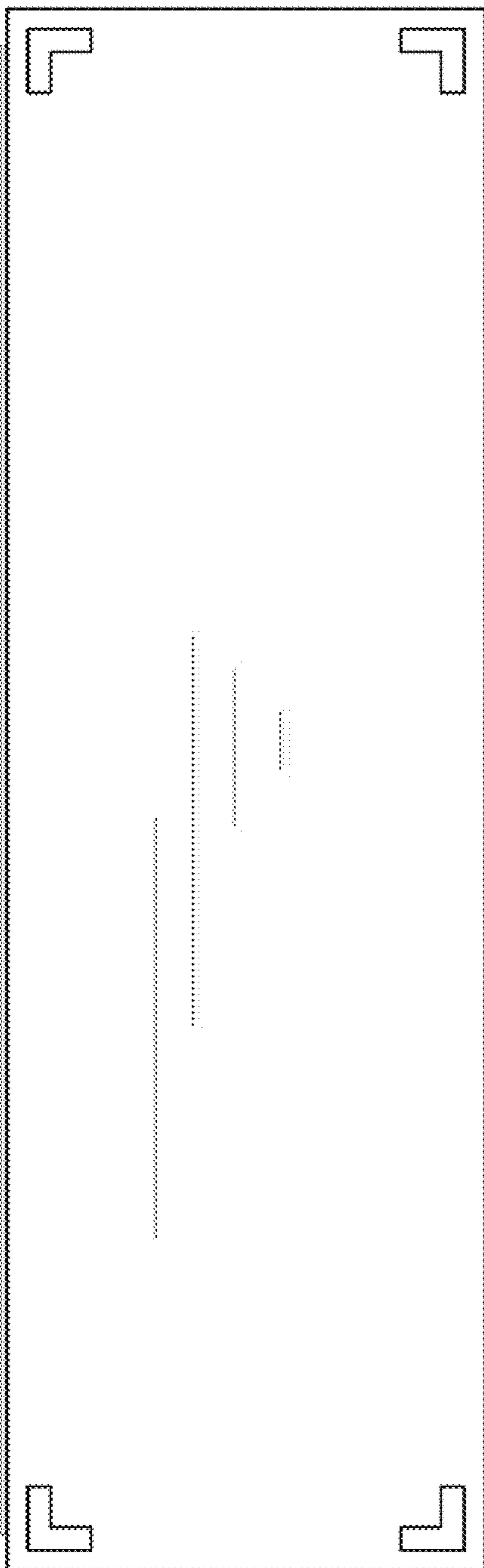

FIG. 4

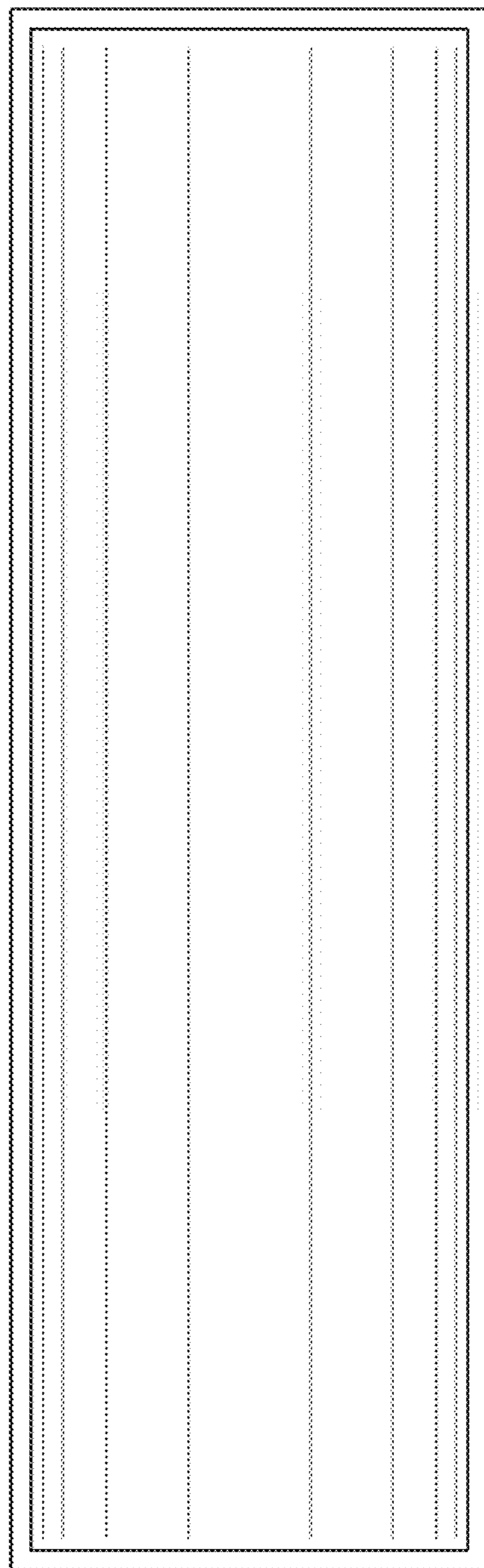

FIG. 5

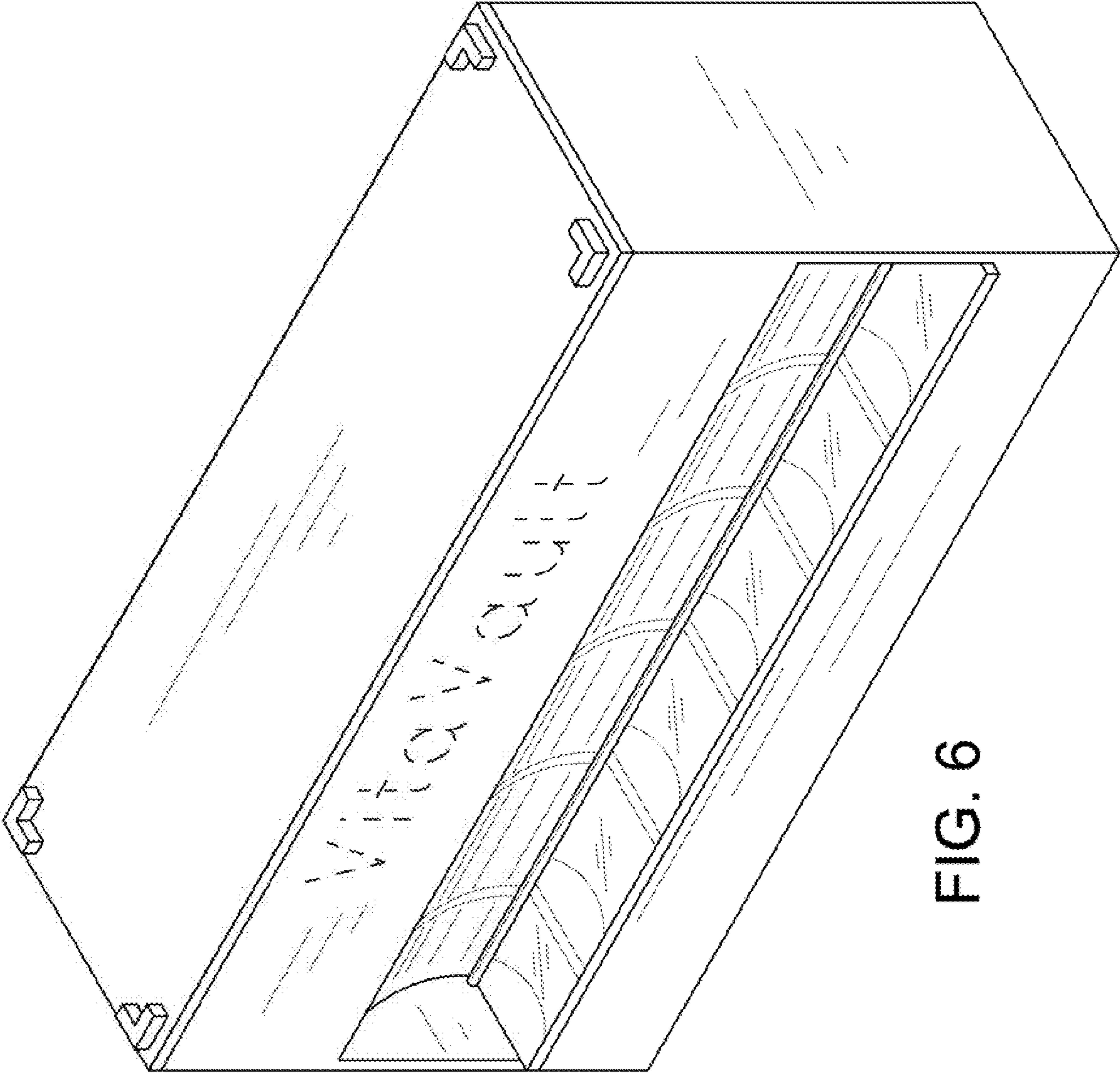

FIG. 6