



US00D613493S

(12) **United States Design Patent**
Montecucco

(10) **Patent No.:** **US D613,493 S**

(45) **Date of Patent:** **** Apr. 13, 2010**

(54) **FANCIFUL FABRIC PANEL**

7,185,665 B2 3/2007 You

(76) **Inventor:** **Tom Montecucco**, 5017 W. Houston,
Spokane, WA (US) 99208

(**) **Term:** **14 Years**

(21) **Appl. No.:** **29/319,501**

(22) **Filed:** **Jun. 10, 2008**

(51) **LOC (9) Cl.** **03-03**

(52) **U.S. Cl.** **D3/6**

(58) **Field of Classification Search** D3/5-17;
D21/836-839; 135/15.1, 16, 17, 19, 20.1,
135/25.1, 25.2, 25.4, 25.33, 26, 29-31, 33.4,
135/33.41

See application file for complete search history.

(56) **References Cited**

U.S. PATENT DOCUMENTS

1,484,367	A	2/1924	Vincent	
1,567,861	A	12/1925	Rothschild	
D101,291	S *	9/1936	Schrader	D3/6
D101,773	S *	11/1936	Hanna	D3/6
D101,774	S *	11/1936	Hanna	D3/6
D131,284	S *	2/1942	Frances	D3/6
D156,673	S *	12/1949	Sabotka	D3/6
5,655,557	A	8/1997	Martin	
D396,741	S *	8/1998	Vitali et al.	D3/5
6,167,894	B1	1/2001	Lin	
6,925,745	B1	8/2005	Alessi	

OTHER PUBLICATIONS

“The Montana Decoy Turkey Flock”, 3 pages, website: <http://www.guidesandlodges.com/mcpherson/PhotosTurkey/go>, Jun. 18, 2008.

“The Montana Decoy Turkey Flock”, 2 pages, website: http://www.guidesandlodges.com/mcpherson/Turkey_index/go, Jun. 18, 2008.

* cited by examiner

Primary Examiner—T. Chase Nelson

Assistant Examiner—Anhdao Doan

(74) *Attorney, Agent, or Firm*—Wells St. John P.S.

(57) **CLAIM**

I claim the ornamental design for a fanciful fabric panel, as shown and described.

DESCRIPTION

FIG. 1 is a front perspective view of a fanciful fabric panel showing inventor’s new design;

FIG. 2 is a front elevational view thereof;

FIG. 3 is a right side elevational view thereof, the left side being a mirror image thereof;

FIG. 4 is a top plan view thereof;

FIG. 5 is a bottom plan view thereof; and,

FIG. 6 is a rear elevational view thereof.

The broken line showing of the fanciful fabric panel in FIGS. 1-6 is included for the purpose of illustrating environmental matter and forms no part of the claimed design.

1 Claim, 6 Drawing Sheets

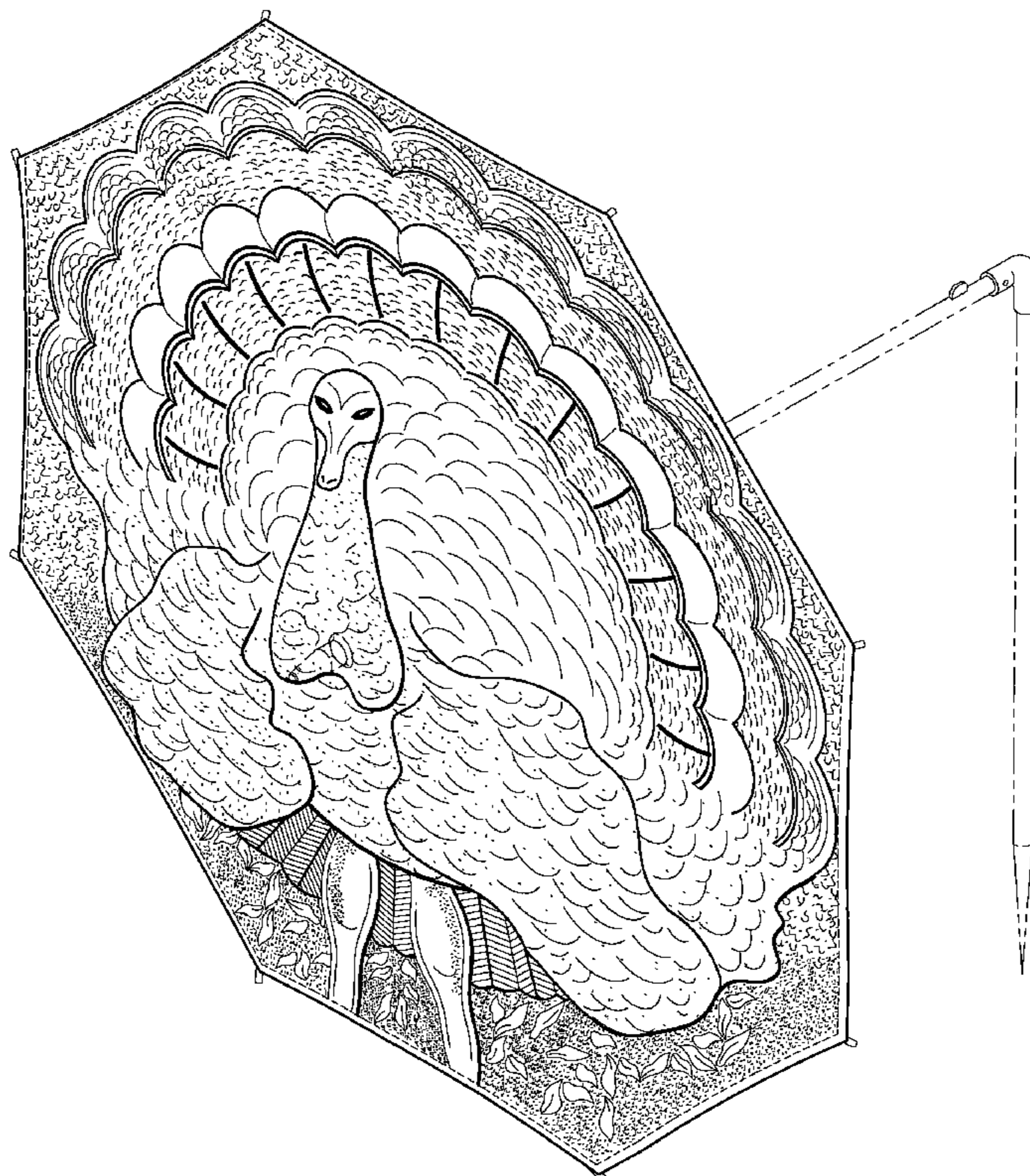

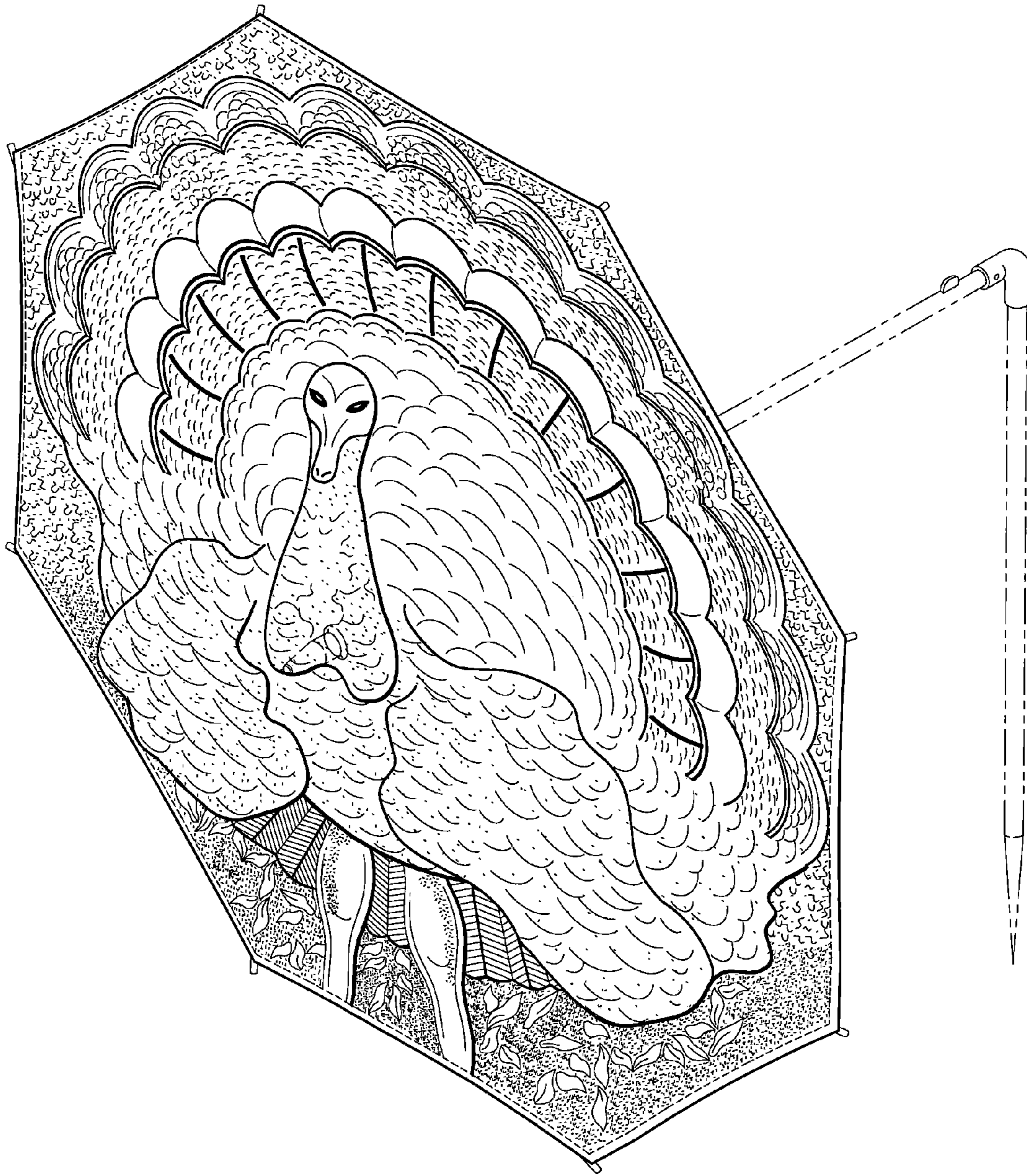
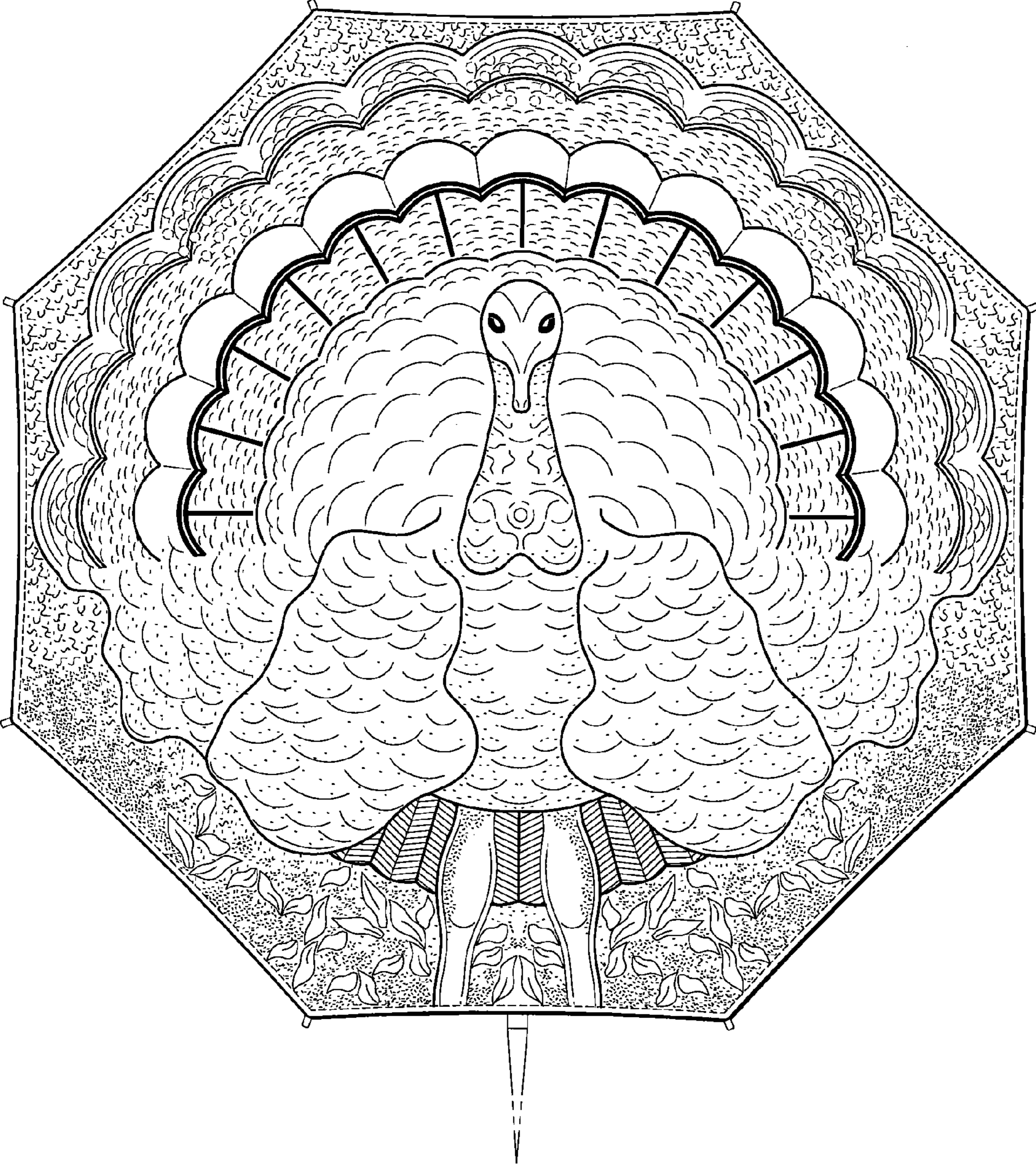
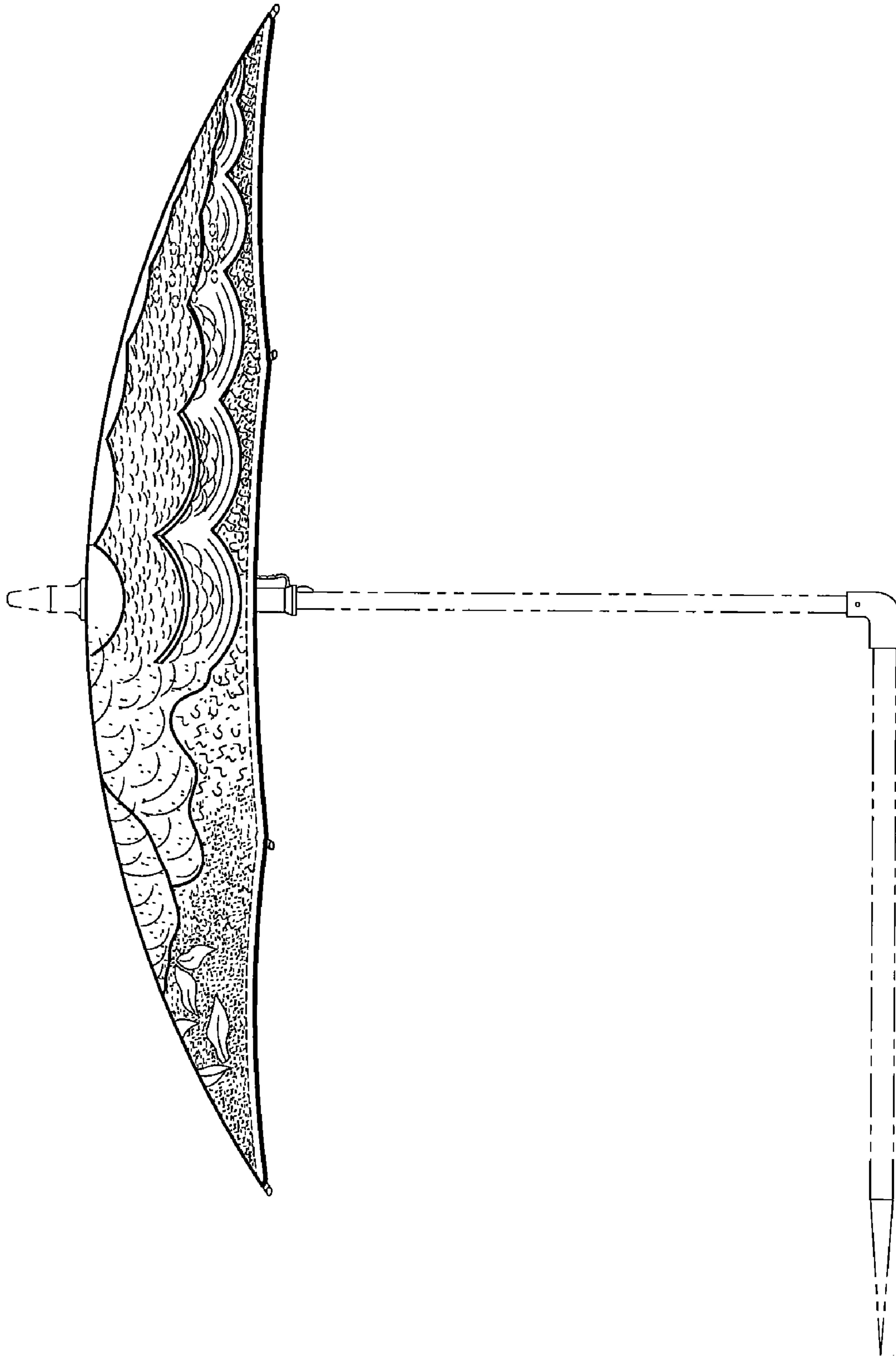

FIG. 1



II 5 07 2



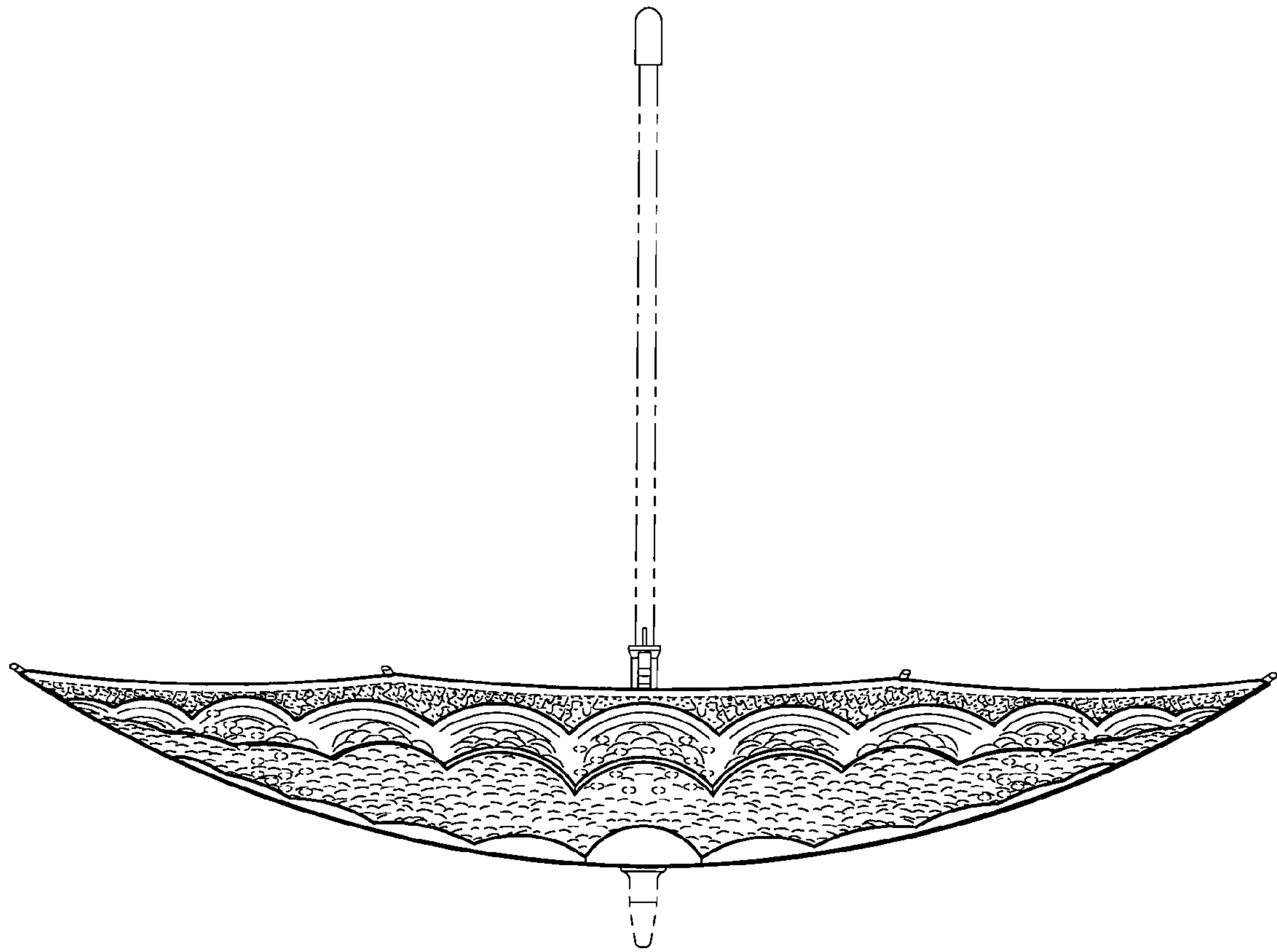
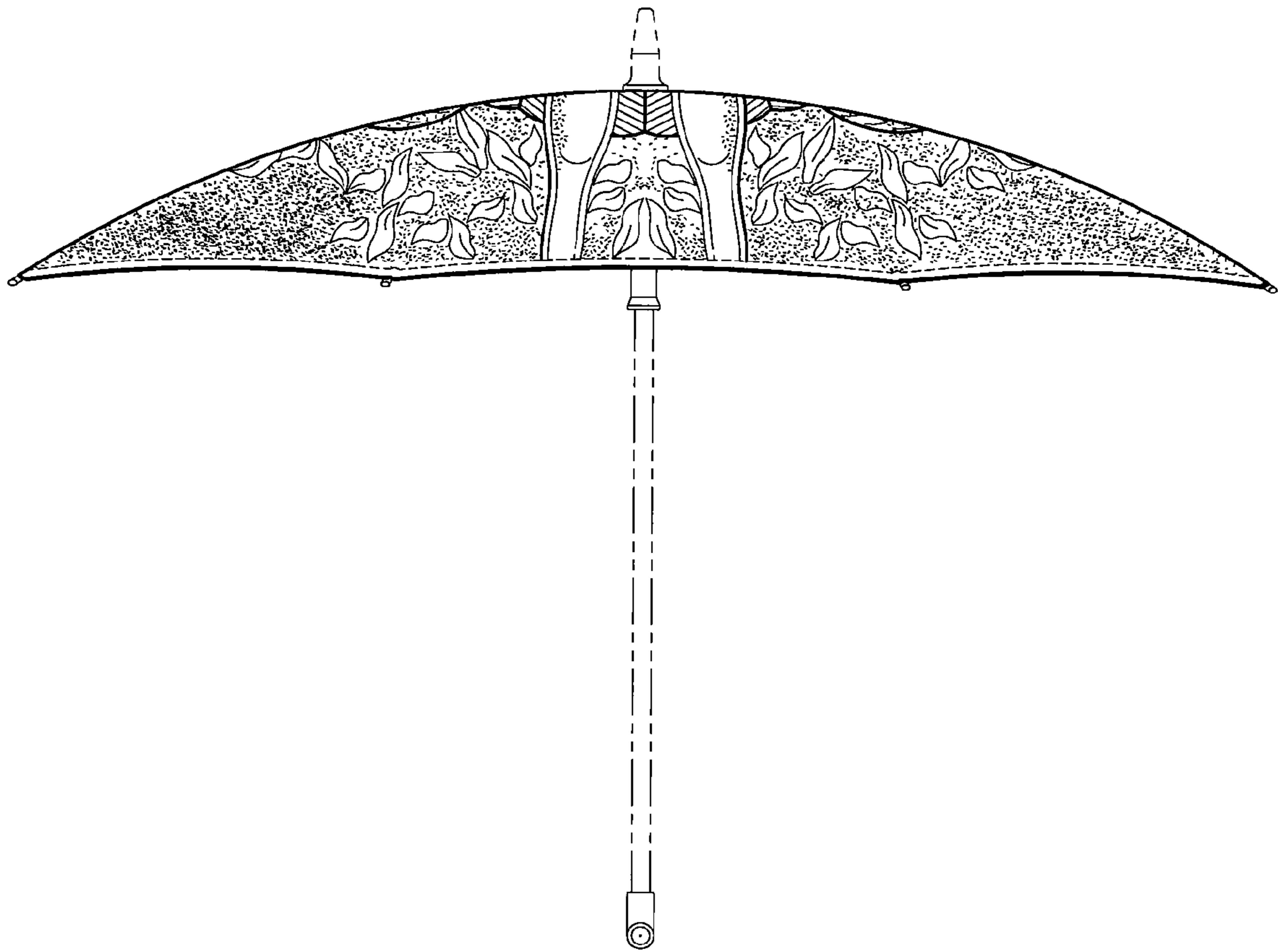

FIG. 4



U.S. Pat. & TM Off.

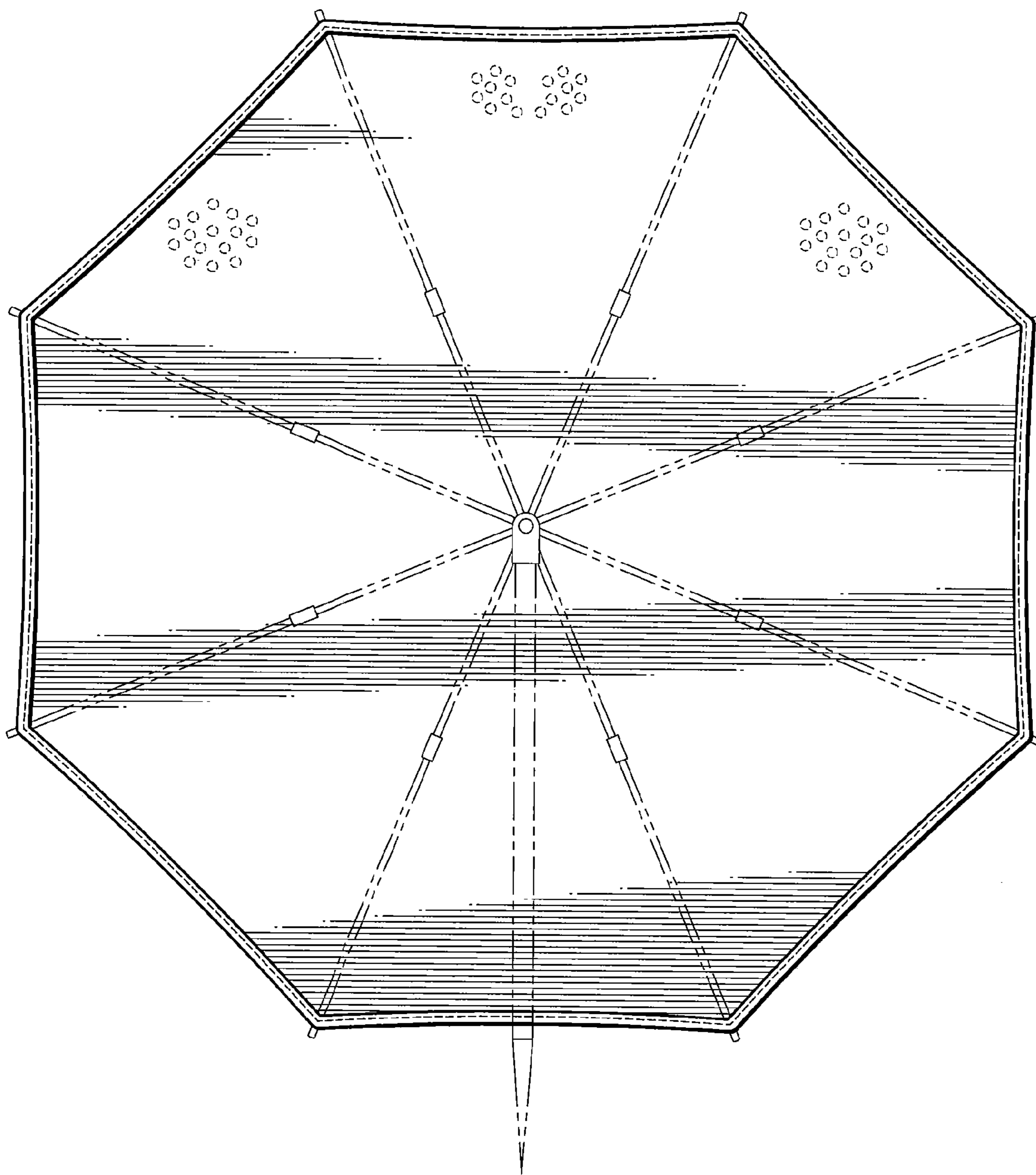

FIG. 6