



US00D613440S

(12) **United States Design Patent**
Lindholm

(10) **Patent No.:** **US D613,440 S**
(45) **Date of Patent:** **** Apr. 6, 2010**

(54) **WORKLIGHT**

(75) Inventor: **Janne Lindholm**, Pietarsaari (FI)

(73) Assignee: **Hermans Oy AB**, Pietarsaari (FI)

(**) Term: **14 Years**

(21) Appl. No.: **29/310,913**

(22) Filed: **Sep. 16, 2008**

(51) **LOC (9) Cl.** **26-05**

(52) **U.S. Cl.** **D26/63**

(58) **Field of Classification Search** D26/60-66;
362/269, 275, 277-280, 282, 285, 287, 289,
362/418, 427, 430

See application file for complete search history.

(56) **References Cited**

U.S. PATENT DOCUMENTS

D179,877 S * 3/1957 Arkin D26/63
D440,338 S * 4/2001 Austin D26/63
D545,987 S * 7/2007 Guercio D26/63

D572,856 S * 7/2008 Kehl et al. D26/61

* cited by examiner

Primary Examiner—Susan Moon Lee

Assistant Examiner—Linda G. Brooks

(74) *Attorney, Agent, or Firm*—Klauber & Jackson LLC

(57) **CLAIM**

The ornamental design for a worklight, as shown and described.

DESCRIPTION

FIG. 1 is a perspective view showing the left side, the bottom and the front of the worklight of my new design;

FIG. 2 is a front view thereof;

FIG. 3 is a back view thereof;

FIG. 4 is a right side view thereof;

FIG. 5 is a left side view thereof;

FIG. 6 is a bottom view thereof; and,

FIG. 7 is a top view of the claimed design.

1 Claim, 4 Drawing Sheets

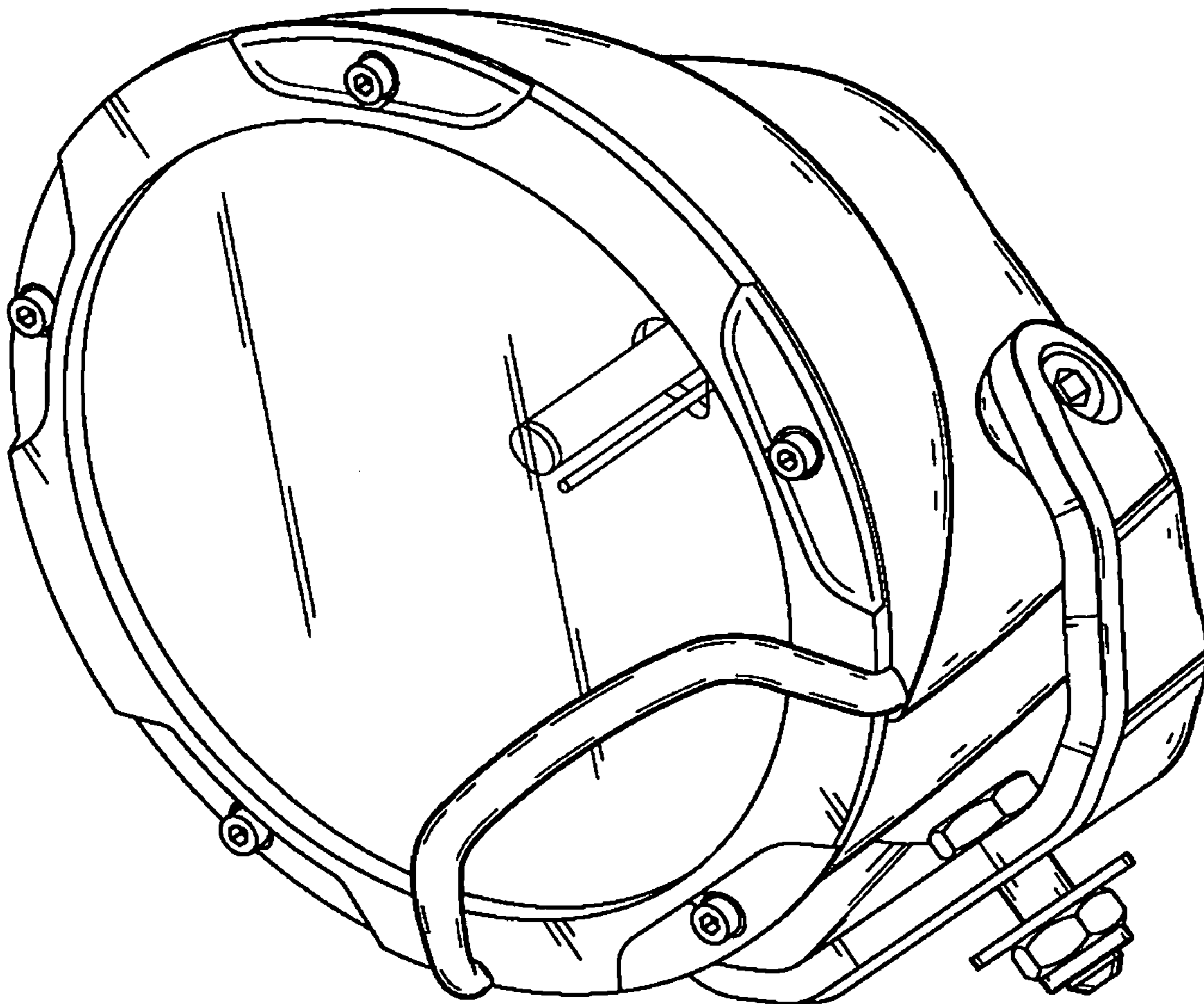

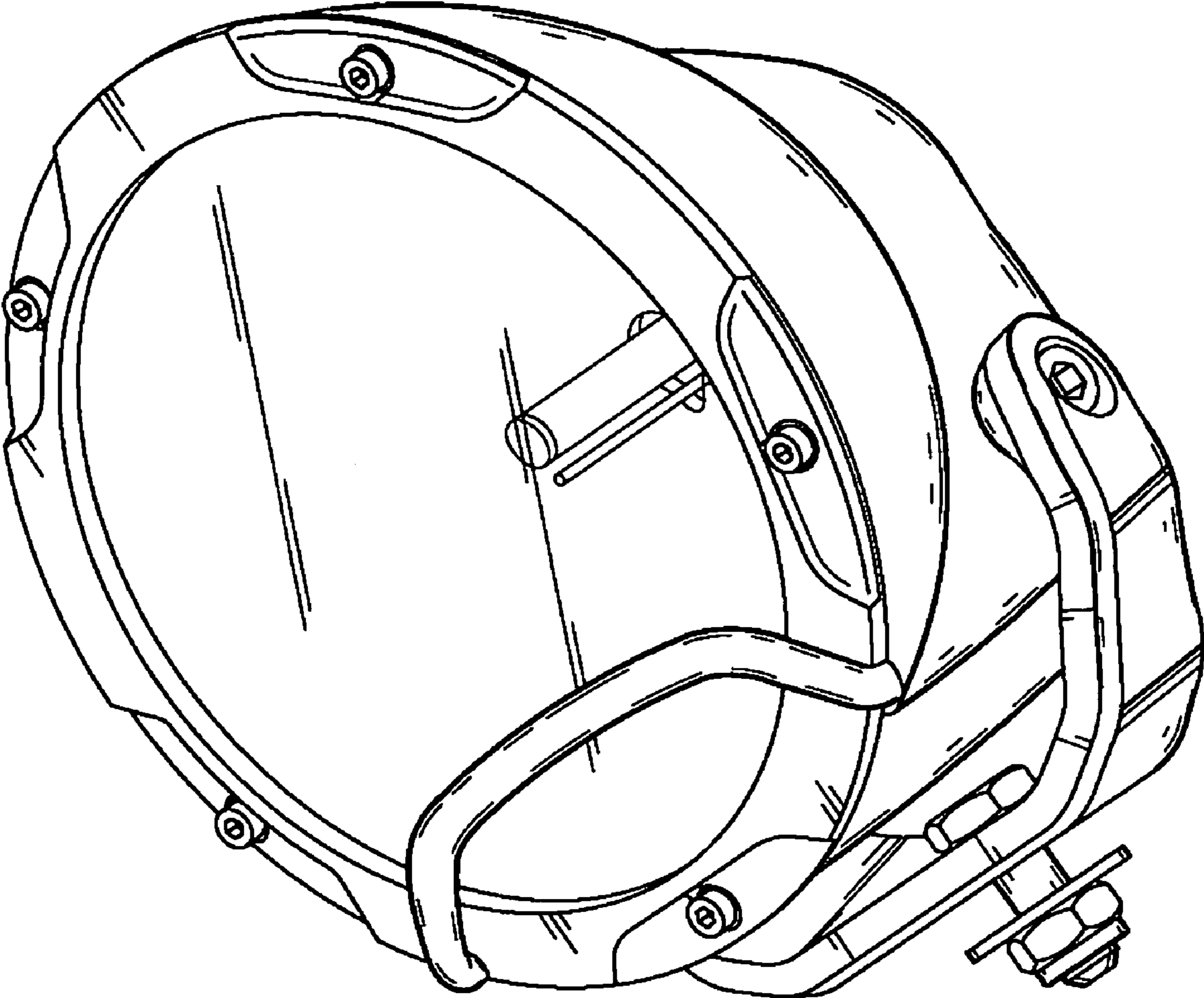

Fig. 1

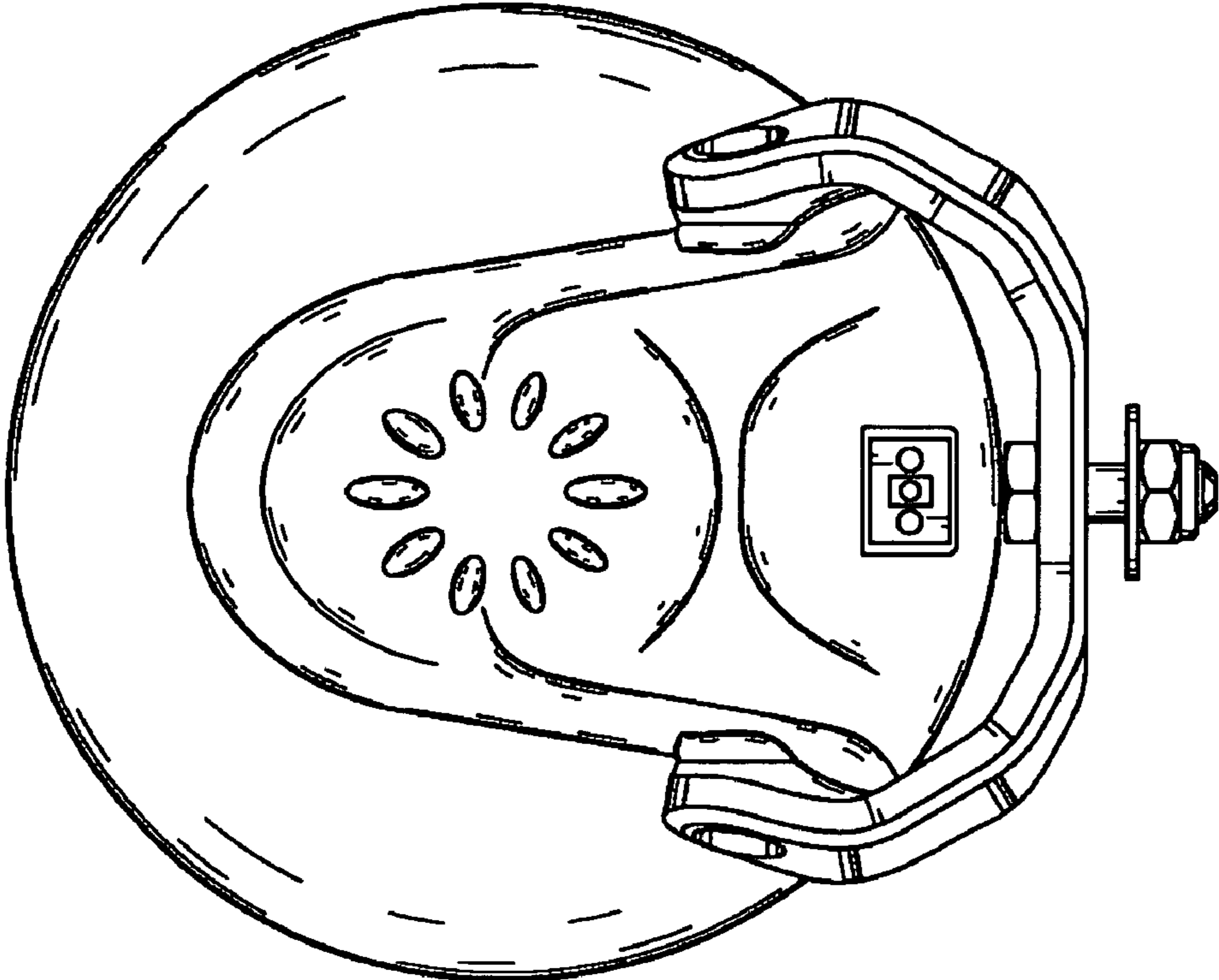

Fig. 3

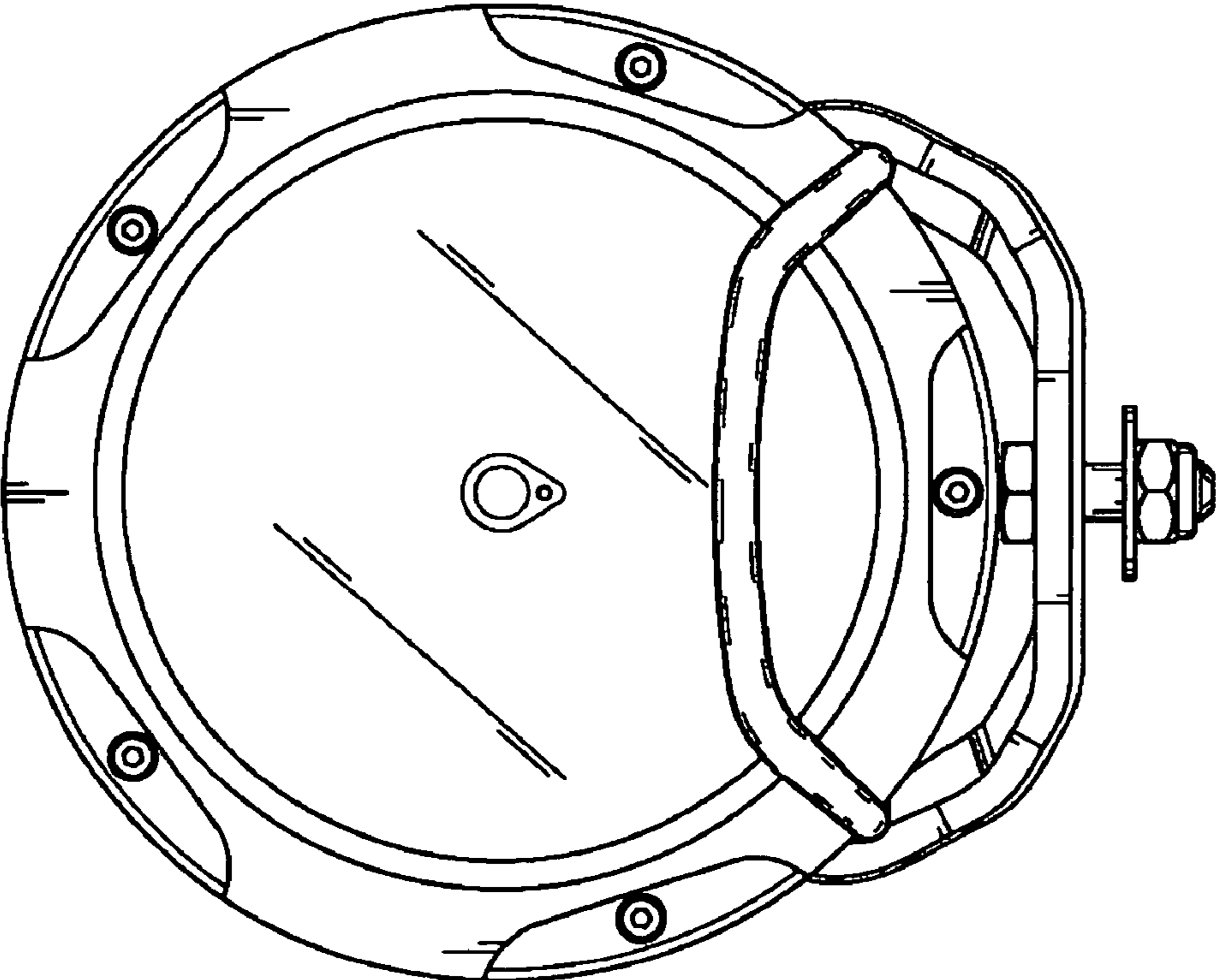

Fig. 2

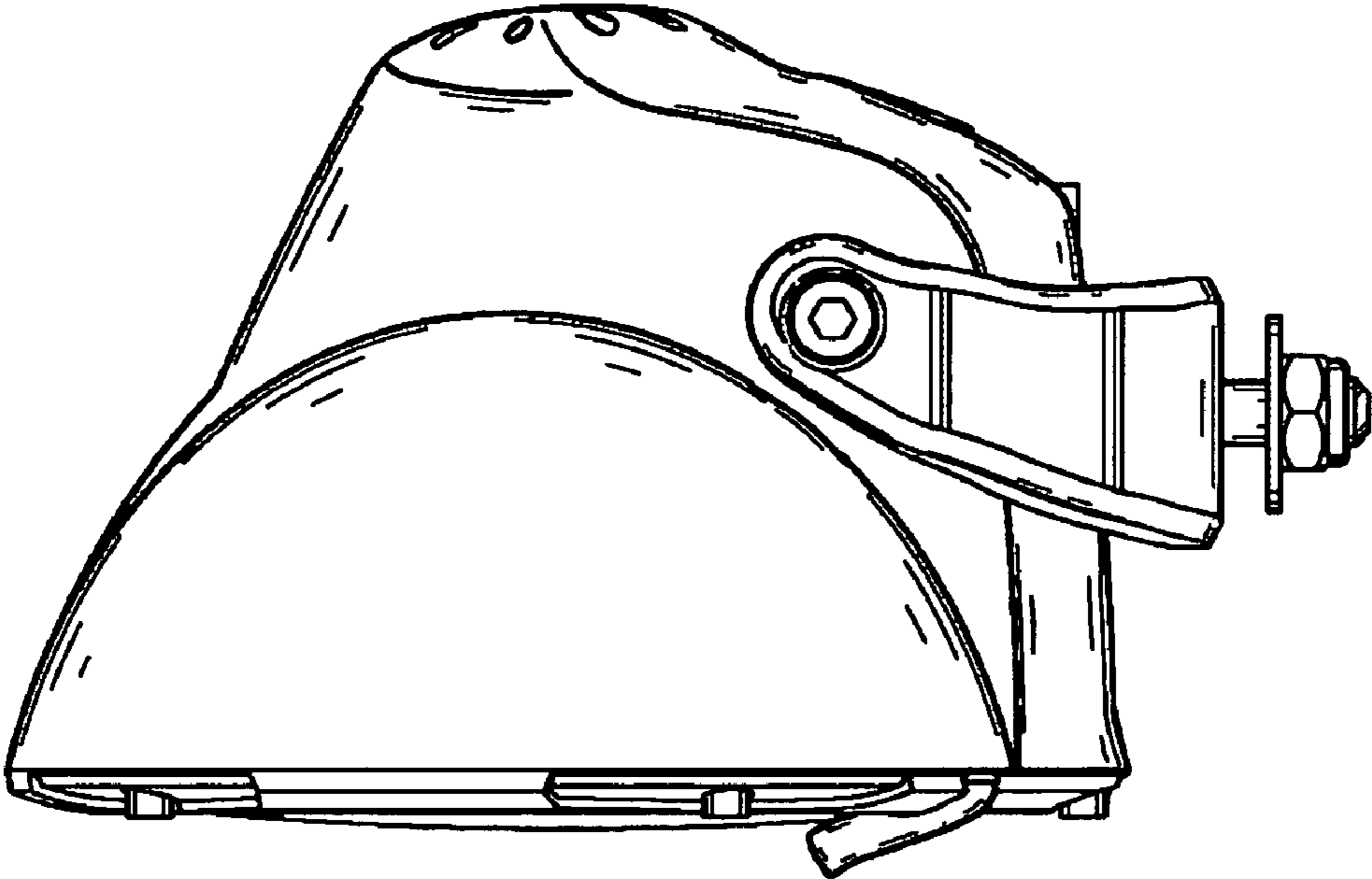

Fig. 5

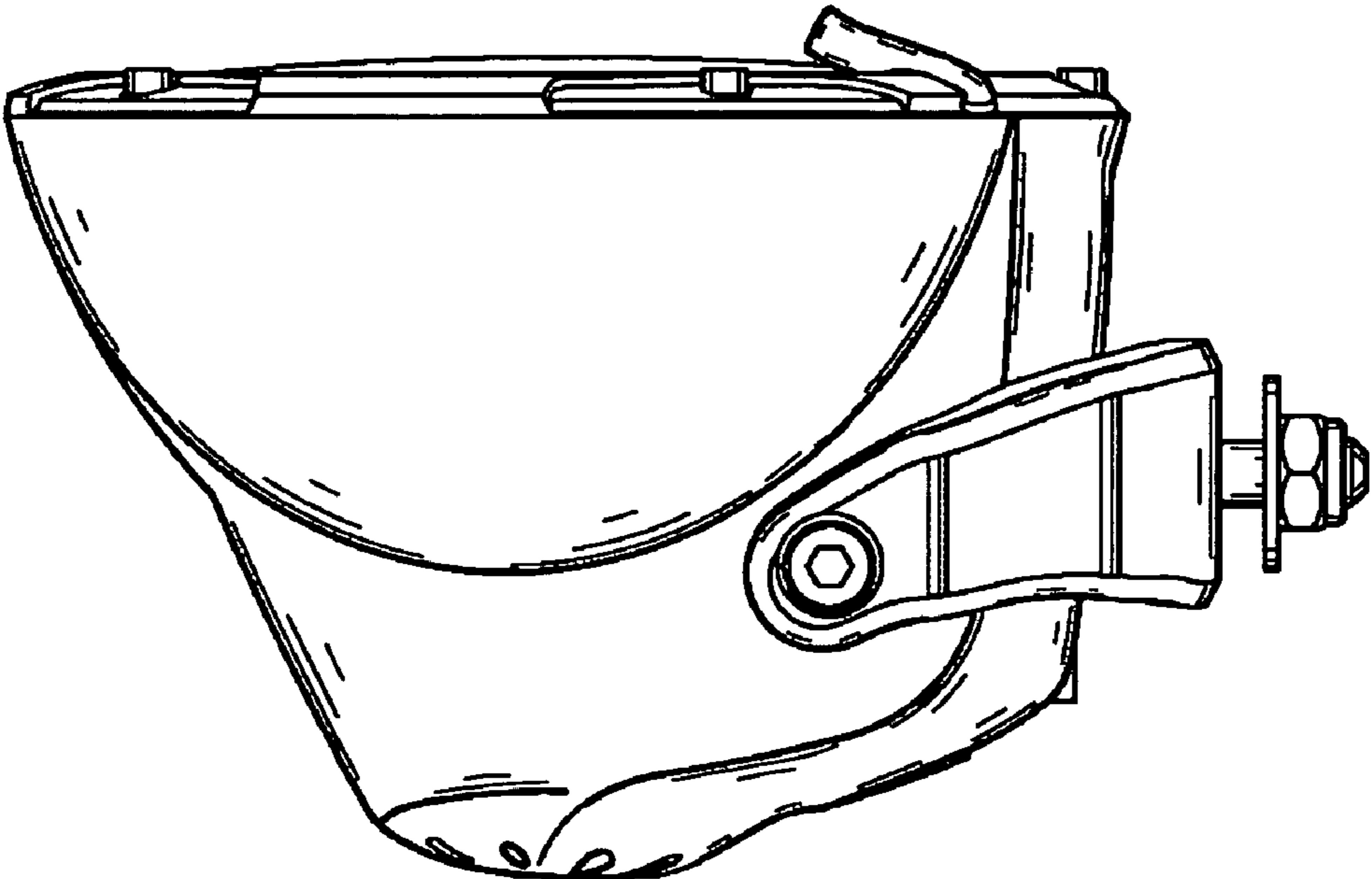

Fig. 4

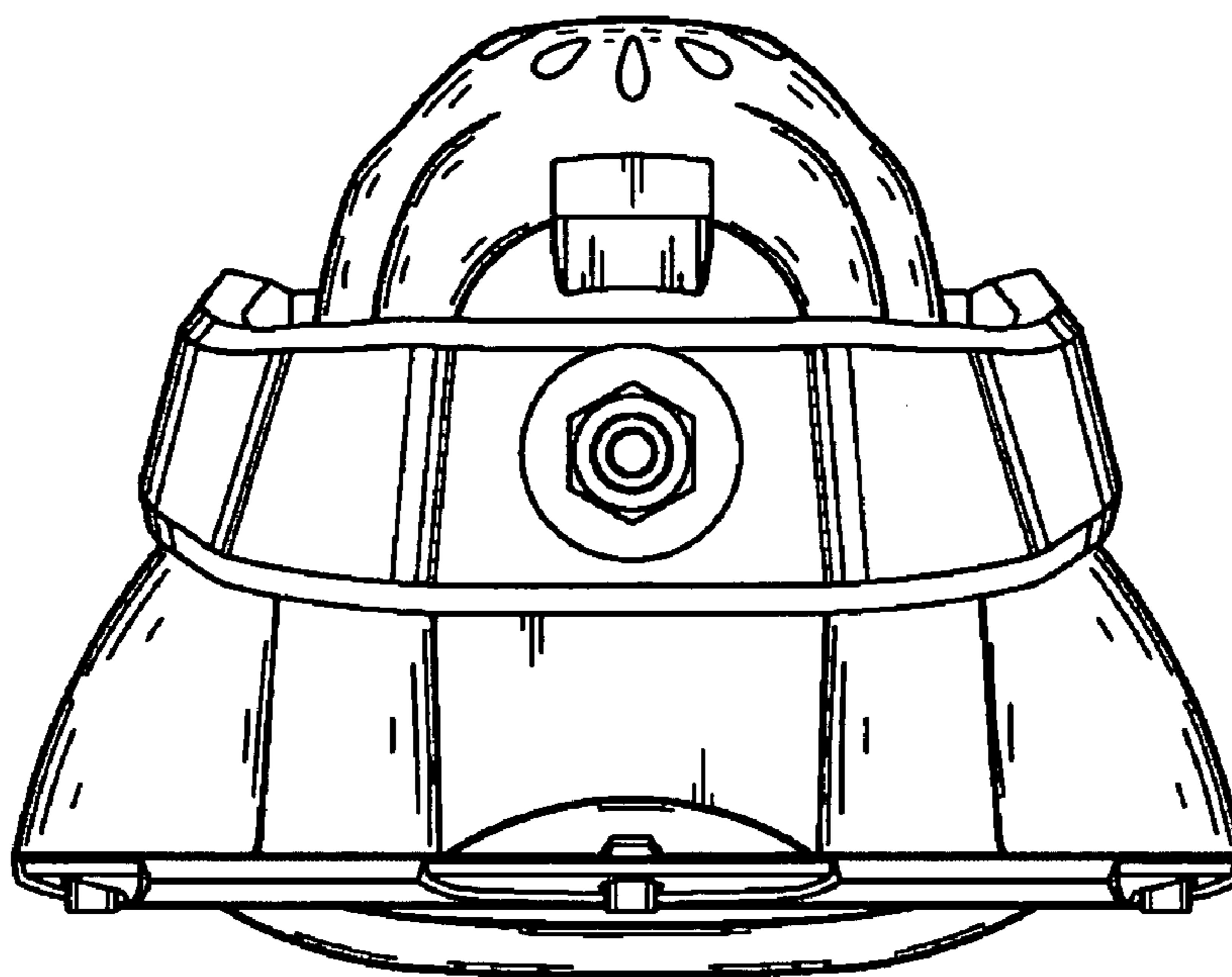

Fig. 6

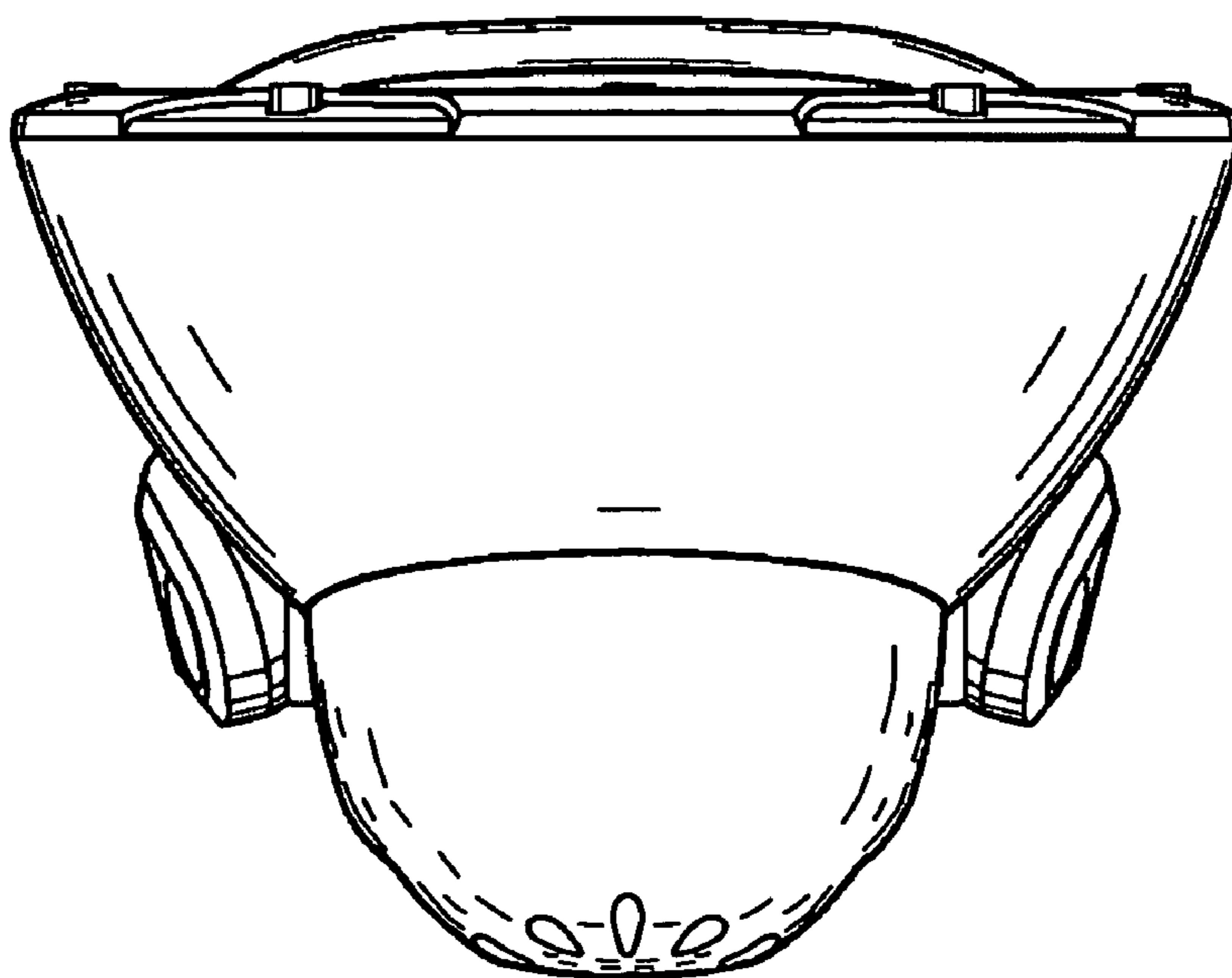

Fig. 7