



US00D613273S

(12) **United States Design Patent**
Linér et al.

(10) **Patent No.:** **US D613,273 S**
(45) **Date of Patent:** **** Apr. 6, 2010**

(54) **HEADSET RECEIVER**

(75) Inventors: **Lina Ester Linér**, Helsinki (FI); **Mirko Manuel Goetzen**, London (GB)

(73) Assignee: **Nokia Corporation**, Espoo (FI)

(**) Term: **14 Years**

(21) Appl. No.: **29/339,590**

(22) Filed: **Jul. 2, 2009**

(51) **LOC (9) Cl.** **14-01**

(52) **U.S. Cl.** **D14/223; D14/225**

(58) **Field of Classification Search** D14/205,
D14/206, 223, 227, 191, 192, 240, 345, 138 AB,
D14/253; 455/90.1, 90.2, 90.3, 347, 352,
455/558; 224/247, 670; 379/420.04; 181/129,
181/130; 381/380, 322, 374; 24/3.12; D13/168
See application file for complete search history.

(56) **References Cited**

U.S. PATENT DOCUMENTS

- D54,979 S * 4/1920 Blackmarr D27/184
- 2,883,523 A * 4/1959 Meserow 342/361
- D223,097 S * 3/1972 Krumin et al. D14/191
- D223,835 S * 6/1972 Schmidt D14/191
- 4,083,481 A * 4/1978 Selinko 224/670
- D287,906 S * 1/1987 Tsuji et al. D3/200
- 4,635,836 A * 1/1987 Mooney et al. 224/247
- D303,529 S * 9/1989 Scheid et al. D14/191
- D304,191 S * 10/1989 Sekine D14/192
- 4,879,759 A * 11/1989 Matsumoto et al. 455/348
- D310,082 S * 8/1990 Kehl et al. D14/227
- D321,865 S * 11/1991 Derocher D14/345
- D352,504 S * 11/1994 Scheid et al. D14/191
- D355,657 S * 2/1995 Scheid et al. D3/218
- 5,488,759 A * 2/1996 Lim et al. 24/3.12
- D379,010 S * 4/1997 Digiani D27/189
- D392,620 S * 3/1998 Ashcraft et al. D13/168
- 5,835,852 A * 11/1998 Bundgardt 455/575.6
- D434,012 S * 11/2000 Krieser, Sr. D13/168
- 6,438,248 B1 * 8/2002 Kamimura et al. 381/374

- D496,023 S * 9/2004 Gubbels et al. D14/191
- D498,735 S * 11/2004 Chen et al. D14/138 AA
- D517,052 S * 3/2006 Skulley D14/223
- 7,050,766 B2 * 5/2006 Liou 455/90.3
- 7,139,590 B2 * 11/2006 Liu et al. 455/557
- D567,216 S * 4/2008 Densho D14/205
- D575,280 S * 8/2008 Marquez D14/240
- D579,924 S 11/2008 Sade
- D579,925 S 11/2008 Jaakkola
- D583,341 S * 12/2008 Wang D14/138 AB
- D583,805 S 12/2008 Jaakkola
- D585,444 S * 1/2009 Verschoor D14/345
- D587,682 S 3/2009 Miles
- D588,113 S 3/2009 Bradford
- D590,377 S 4/2009 Bradford
- D590,378 S 4/2009 Bradford
- D592,191 S 5/2009 Nousianen
- D592,647 S * 5/2009 L'Henaff et al. D14/240

* cited by examiner

Primary Examiner—Paula Greene

(74) *Attorney, Agent, or Firm*—Banner & Witcoff, Ltd.

(57) **CLAIM**

The ornamental design for a headset receiver, as shown and described.

DESCRIPTION

FIG. 1 is a perspective front view of a headset receiver showing my new design;

FIG. 2 is a front plan view thereof;

FIG. 3 is a rear plan view thereof;

FIG. 4 is a right view thereof;

FIG. 5 is a left view thereof;

FIG. 6 is a bottom plan view thereof; and,

FIG. 7 is a top plan view thereof.

The broken line showing the environmental structure is for illustrative purposes only and forms no part of the claimed design.

1 Claim, 3 Drawing Sheets

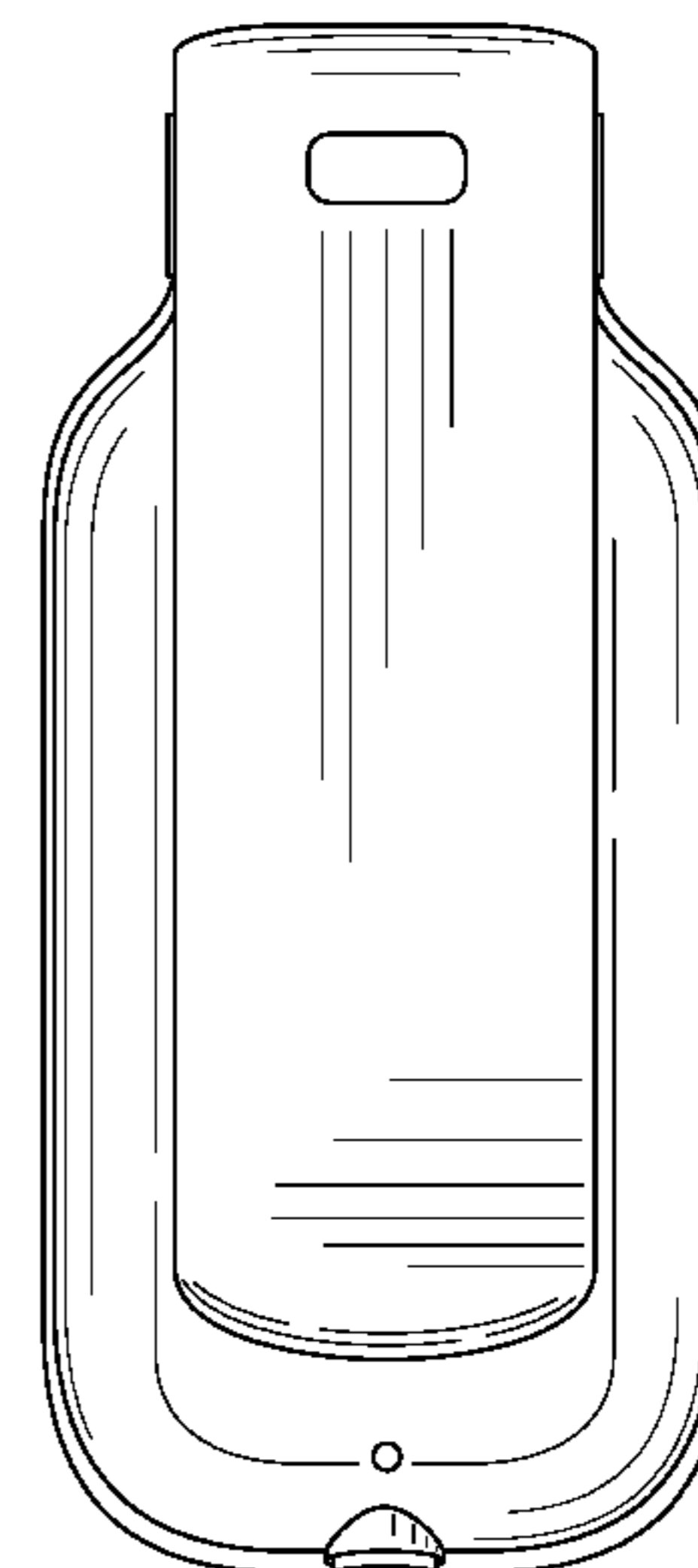
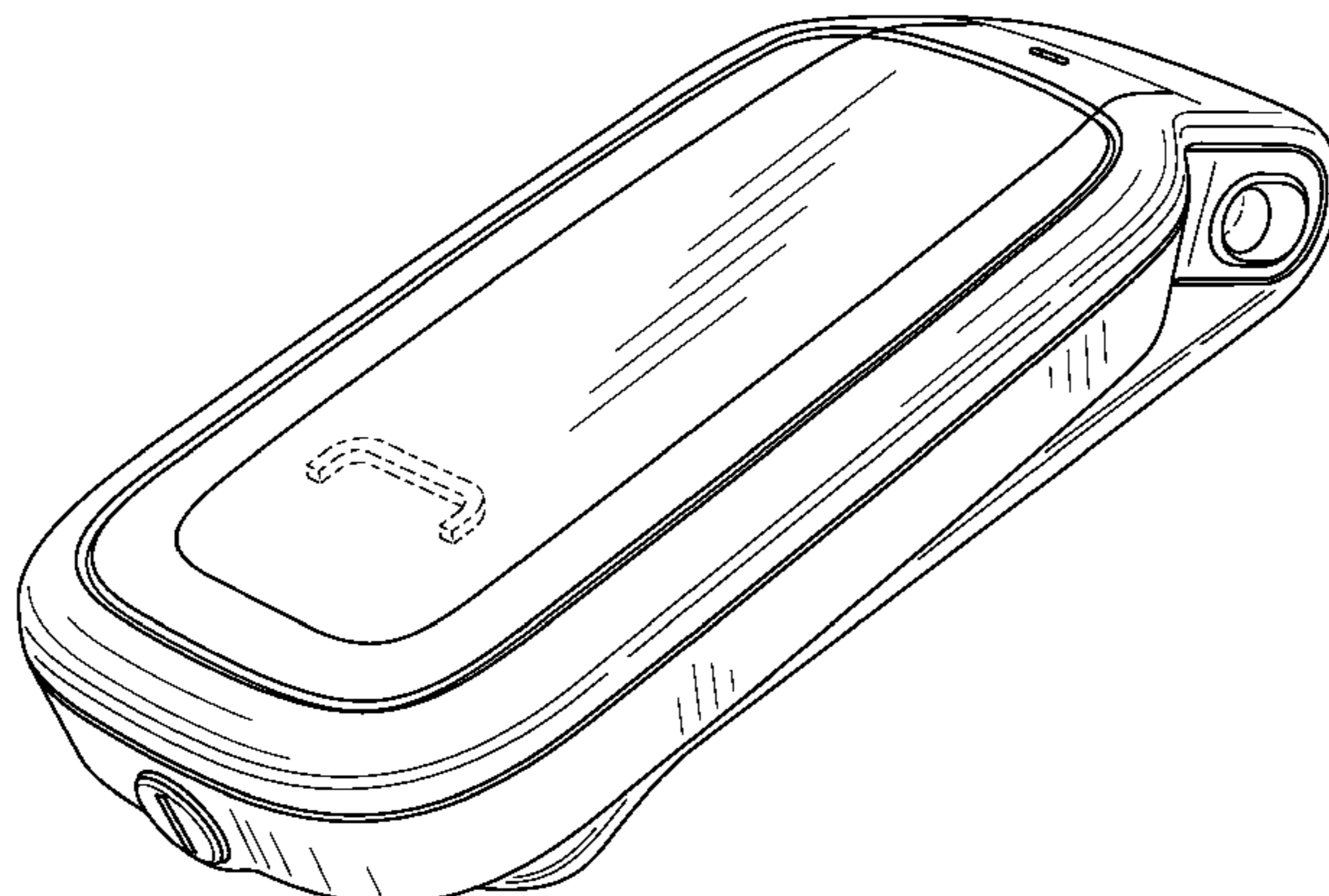

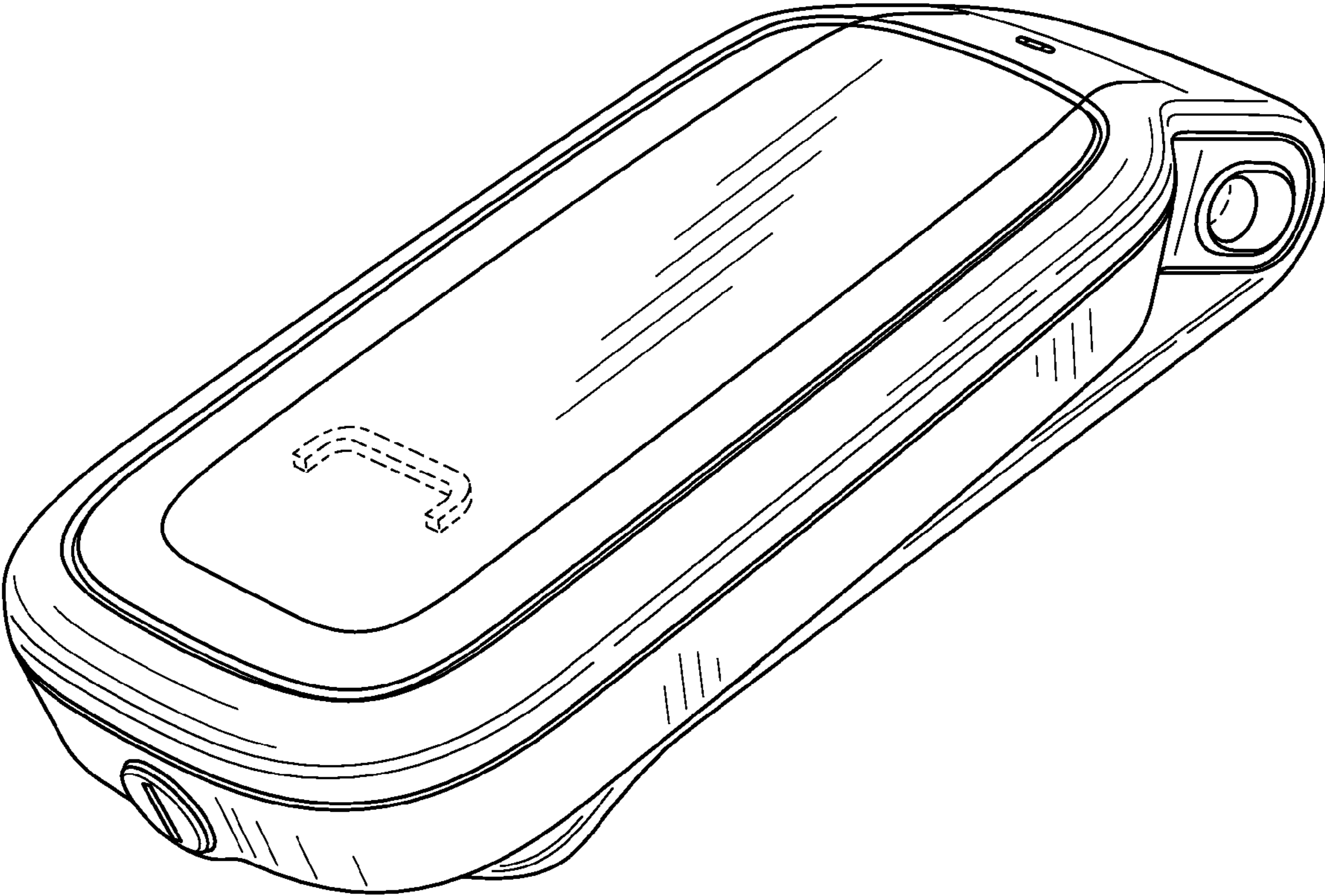

FIG. 1

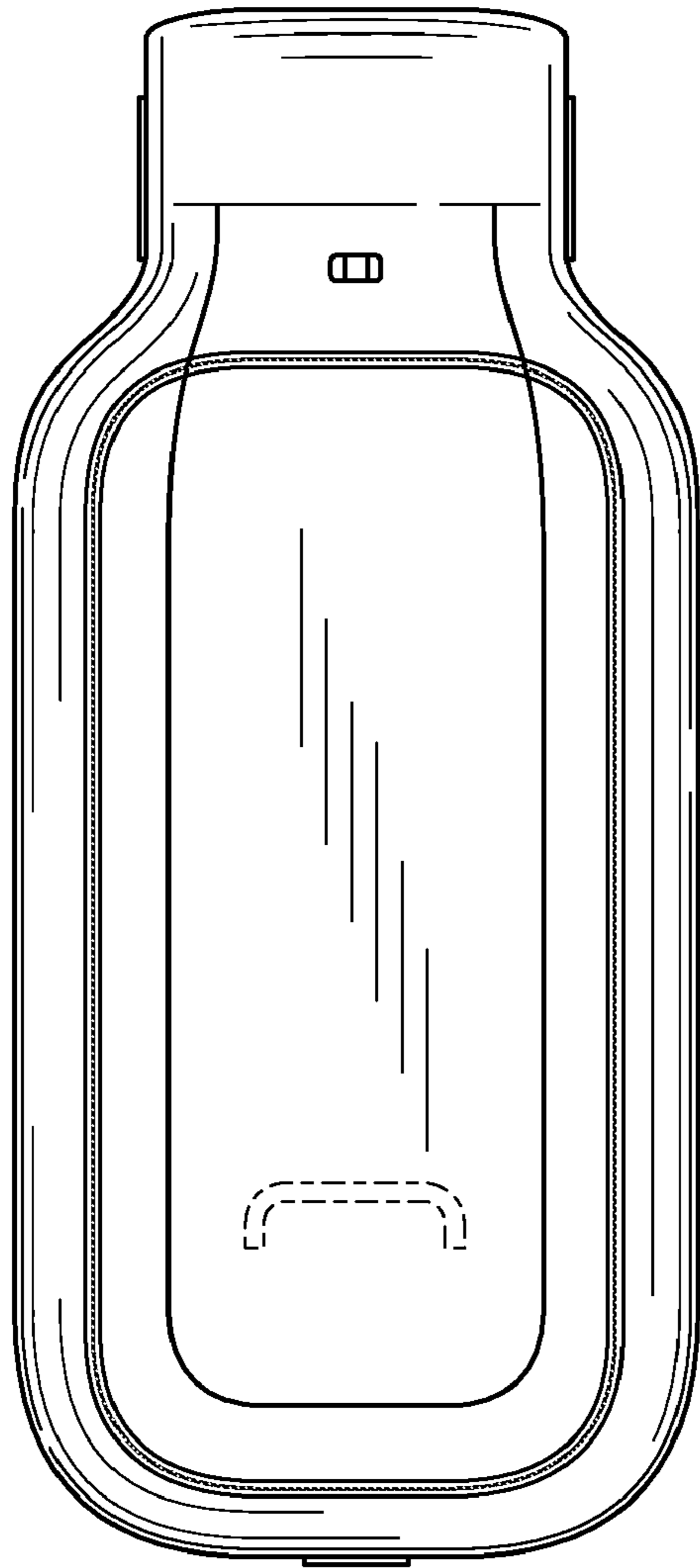

FIG. 2

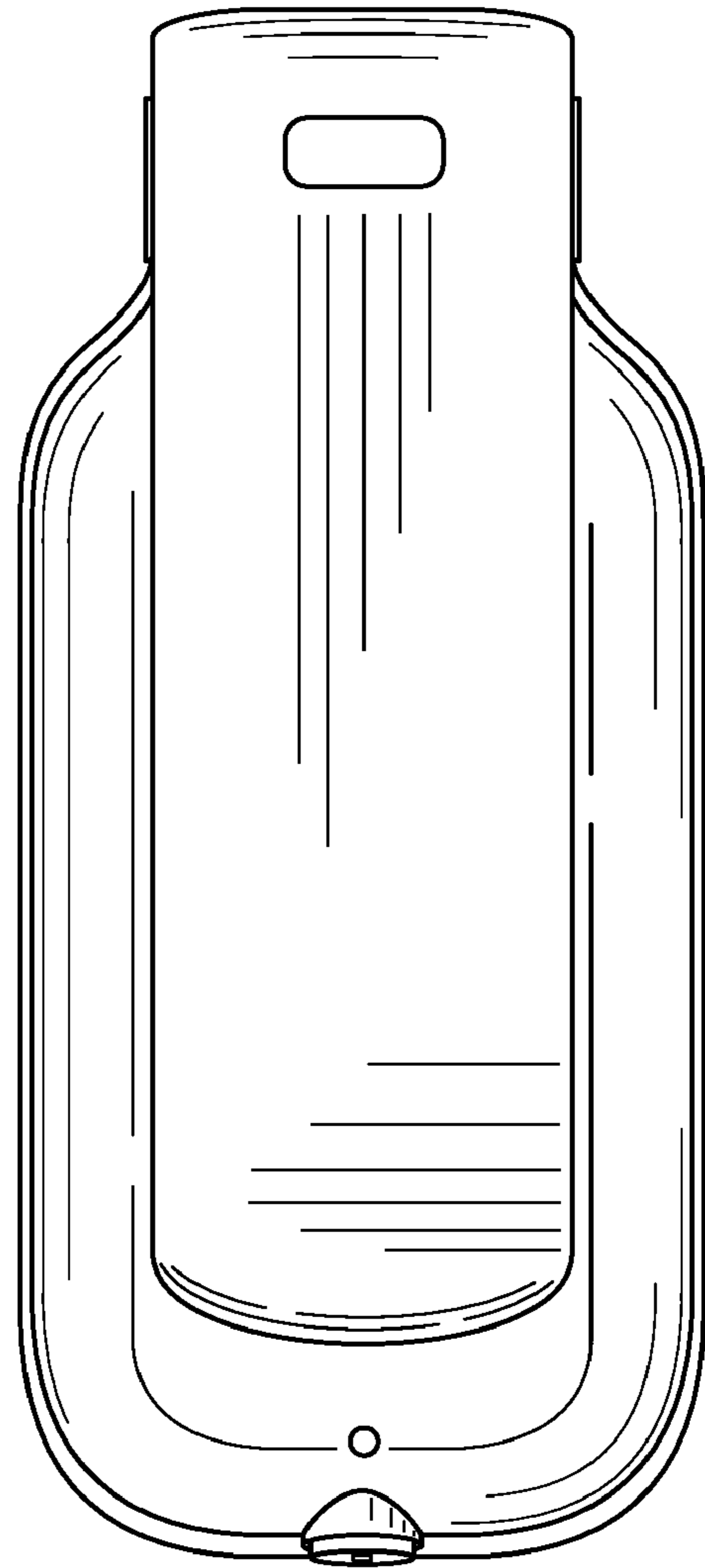

FIG. 3

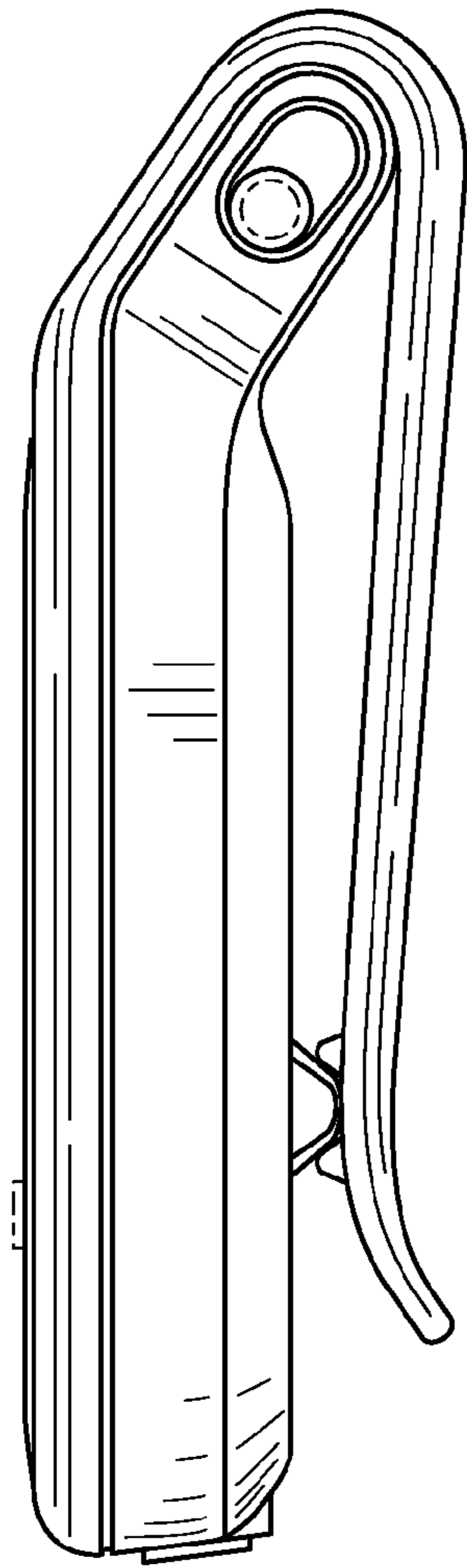

FIG. 4

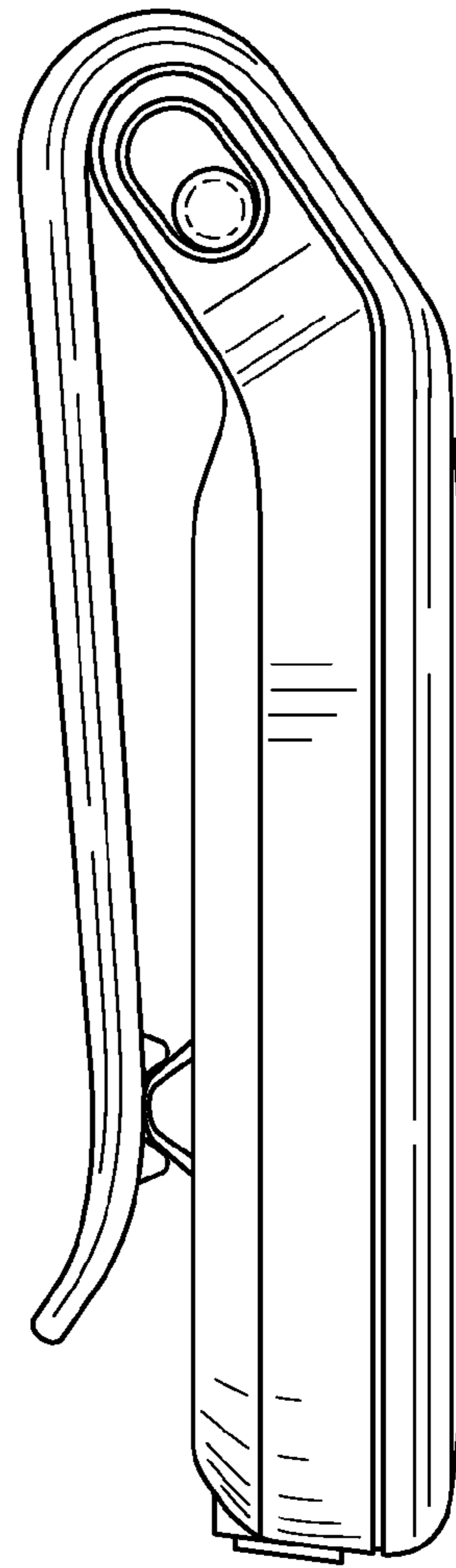

FIG. 5

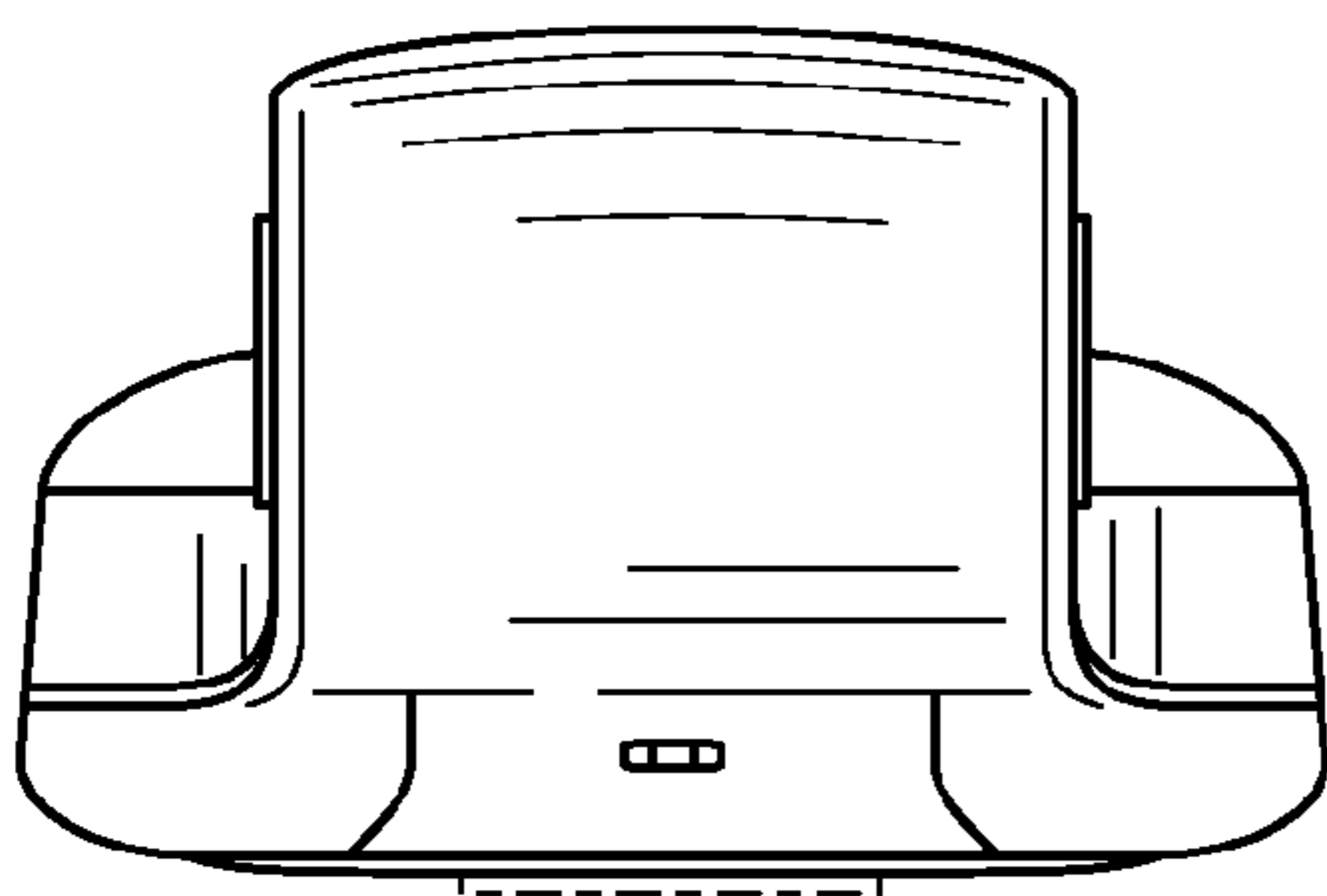

FIG. 6

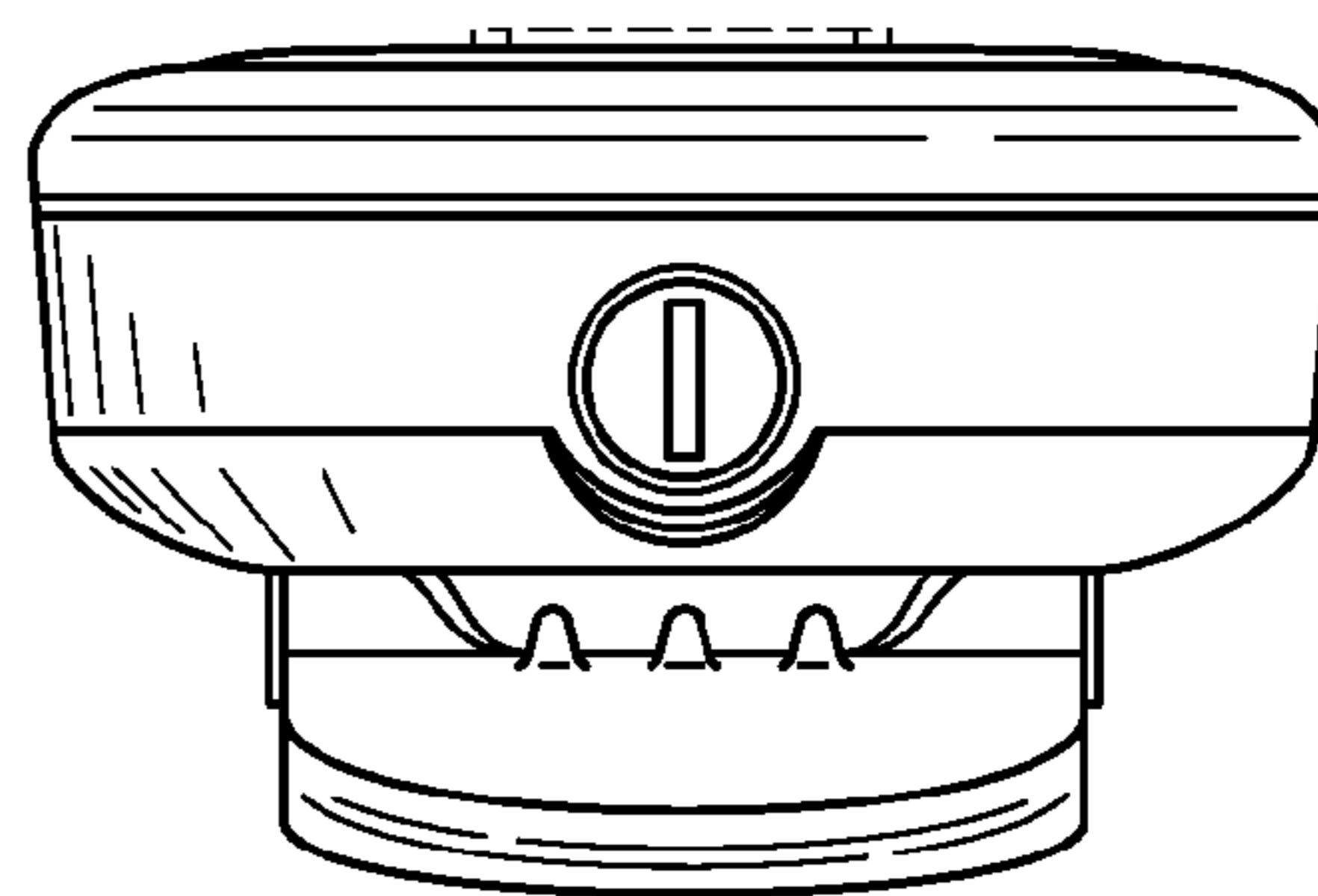

FIG. 7