



US00D613114S

(12) **United States Design Patent**  
**Hewitt**

(10) **Patent No.:** **US D613,114 S**  
(45) **Date of Patent:** **\*\* Apr. 6, 2010**

- (54) **TEA INFUSER**
- (75) Inventor: **Peter Hewitt**, Acton, MA (US)
- (73) Assignee: **Tea Forté, Inc.**, Concord, MA (US)
- (\*\*) Term: **14 Years**
- (21) Appl. No.: **29/316,402**
- (22) Filed: **Jul. 17, 2009**
- (51) **LOC (9) Cl.** ..... **07-99**
- (52) **U.S. Cl.** ..... **D7/400; D7/667**
- (58) **Field of Classification Search** ..... D7/647,  
D7/667, 700, 400, 399, 397; 99/321, 322,  
99/319, 323, 323.3; 210/477  
See application file for complete search history.

(56) **References Cited**

**U.S. PATENT DOCUMENTS**

638,698	A *	12/1899	Bourie	99/321
1,012,680	A *	12/1911	Mayer	99/322
2,234,397	A *	3/1941	Bentz	210/477
5,678,472	A *	10/1997	Millman	99/279
D404,609	S *	1/1999	Miller et al.	D7/400
D447,911	S *	9/2001	Jørgensen	D7/400
6,283,013	B1 *	9/2001	Romandy et al.	99/322
D536,205	S *	2/2007	Jensen et al.	D7/316
D563,161	S *	3/2008	Bodum	D7/400
D565,350	S *	4/2008	Gauger	D7/400
D575,105	S *	8/2008	Gauss	D7/399

**OTHER PUBLICATIONS**

Tea Forte "Behind the Designs" <http://www.teafort.com/about/behind-the-designs/> May 16, 2009 (2 pages).

\* cited by examiner

*Primary Examiner*—Marianne Pandozzi  
(74) *Attorney, Agent, or Firm*—Wolf, Greenfield & Sacks, P.C.

(57) **CLAIM**

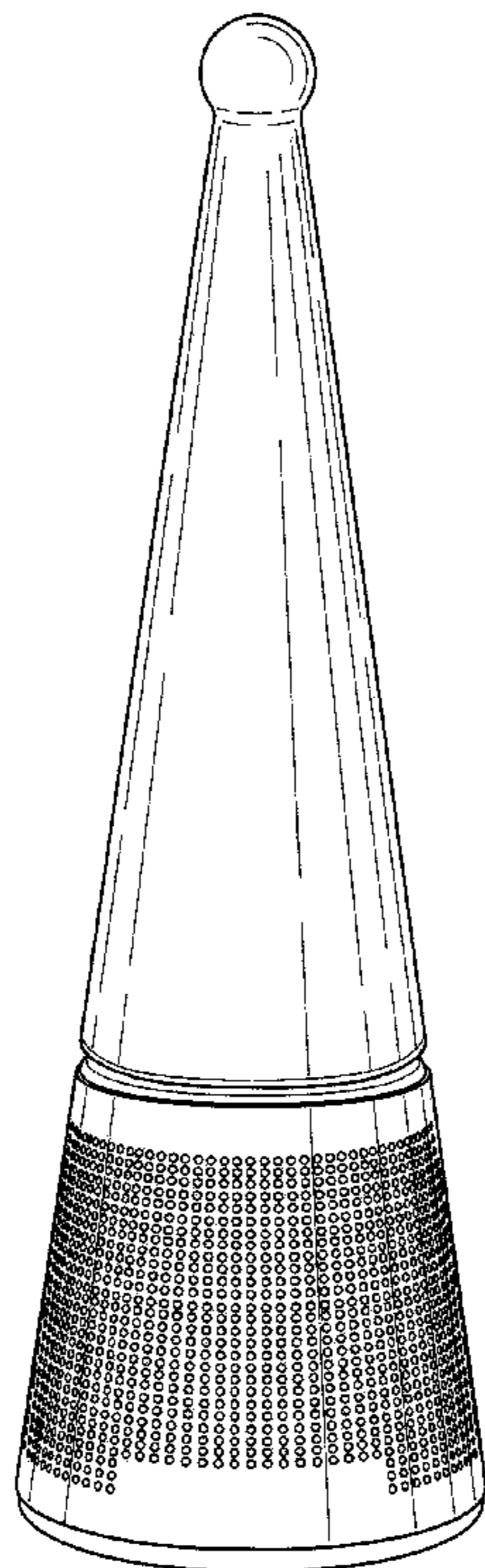
The ornamental design for the tea infuser, as shown and described.

**DESCRIPTION**

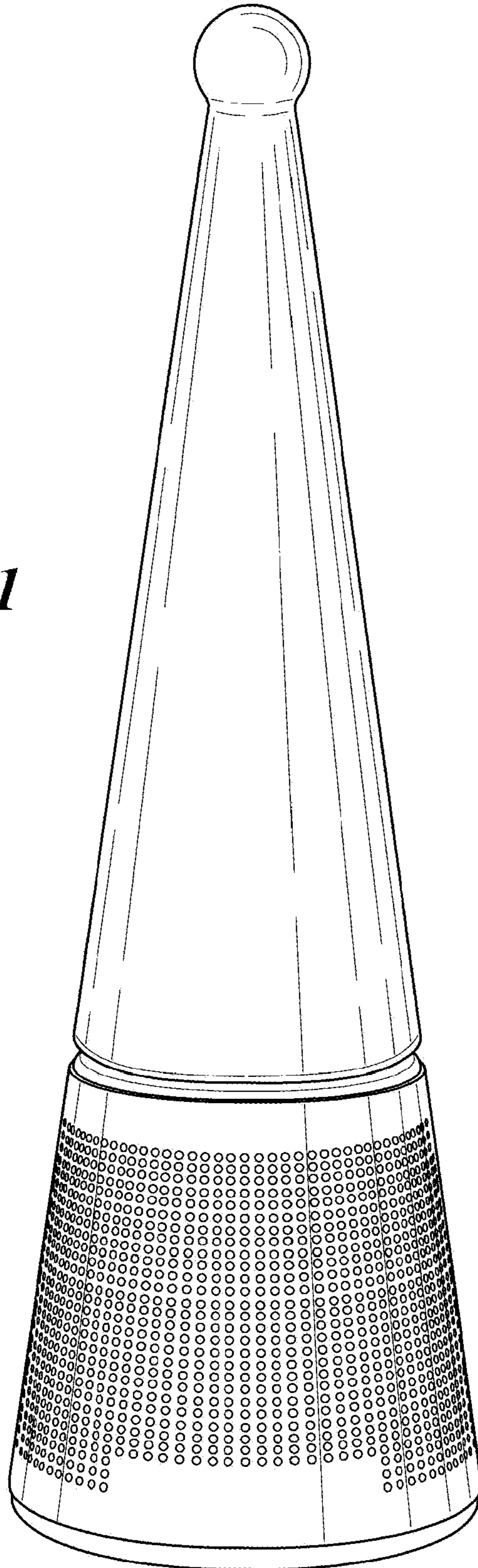
FIG. 1 is a perspective view of the tea infuser of this invention;  
 FIG. 2 is a front view of the tea infuser of this invention;  
 FIG. 3 is a rear view of the tea infuser of this invention;  
 FIG. 4 is a view of a first side of the tea infuser of this invention;  
 FIG. 5 is a view of a second side of the tea infuser of this invention;  
 FIG. 6 is a top view of the tea infuser of this invention;  
 FIG. 7 is a bottom view of the tea infuser of this invention;  
 FIG. 8 is an exploded view of the tea infuser of this invention;  
 and,  
 FIG. 9 is an environmental front view thereof.

The broken line showing of a tray is included for the purpose of illustrating example environment and forms no part of the claimed design.

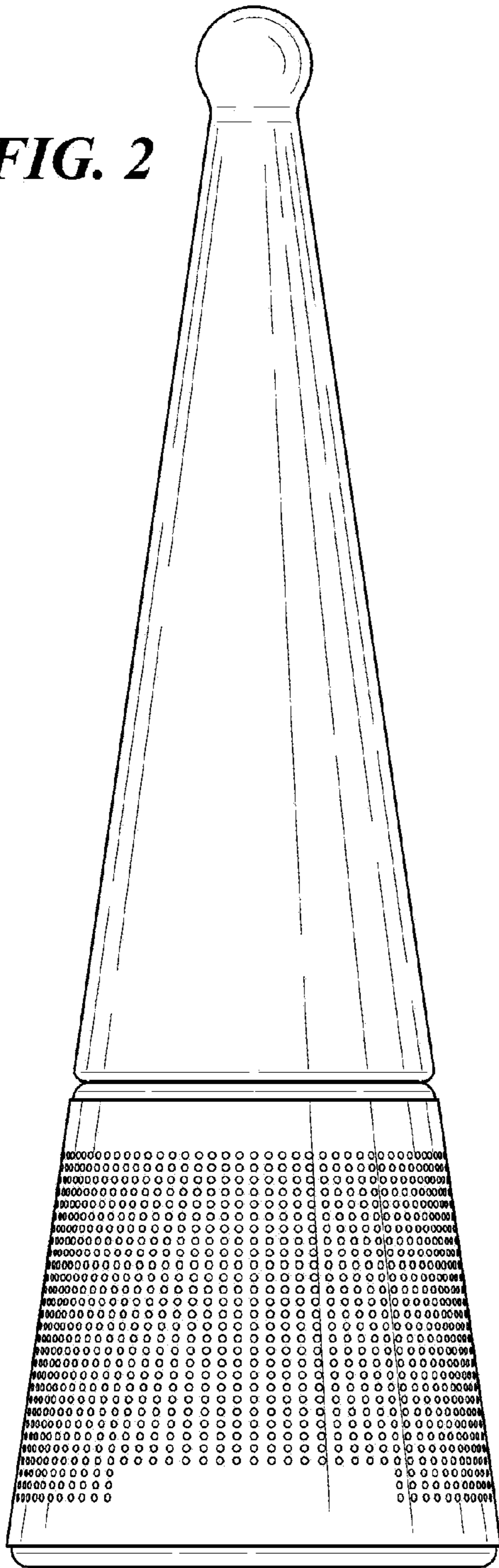
**1 Claim, 6 Drawing Sheets**



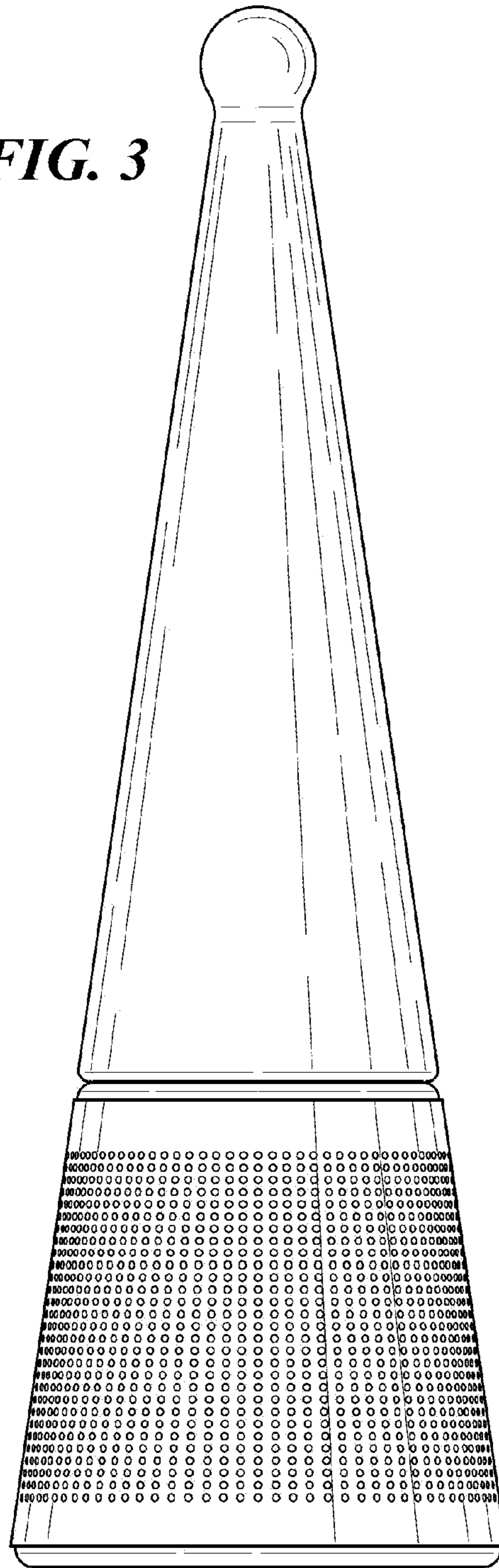
**FIG. 1**

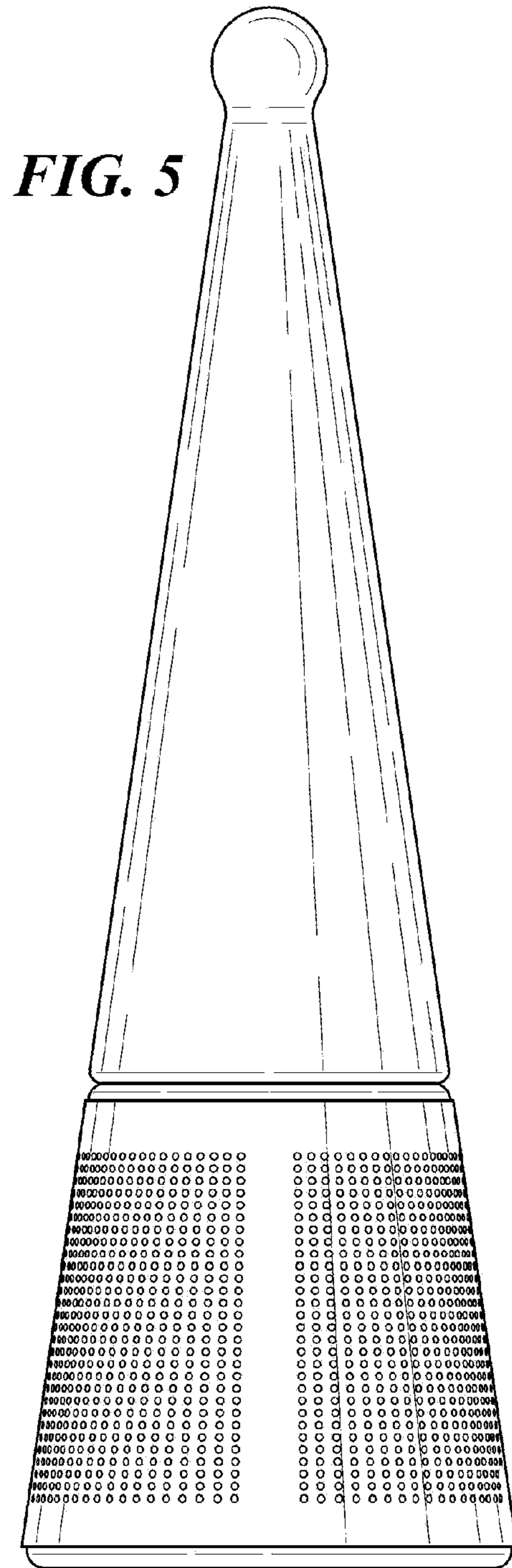
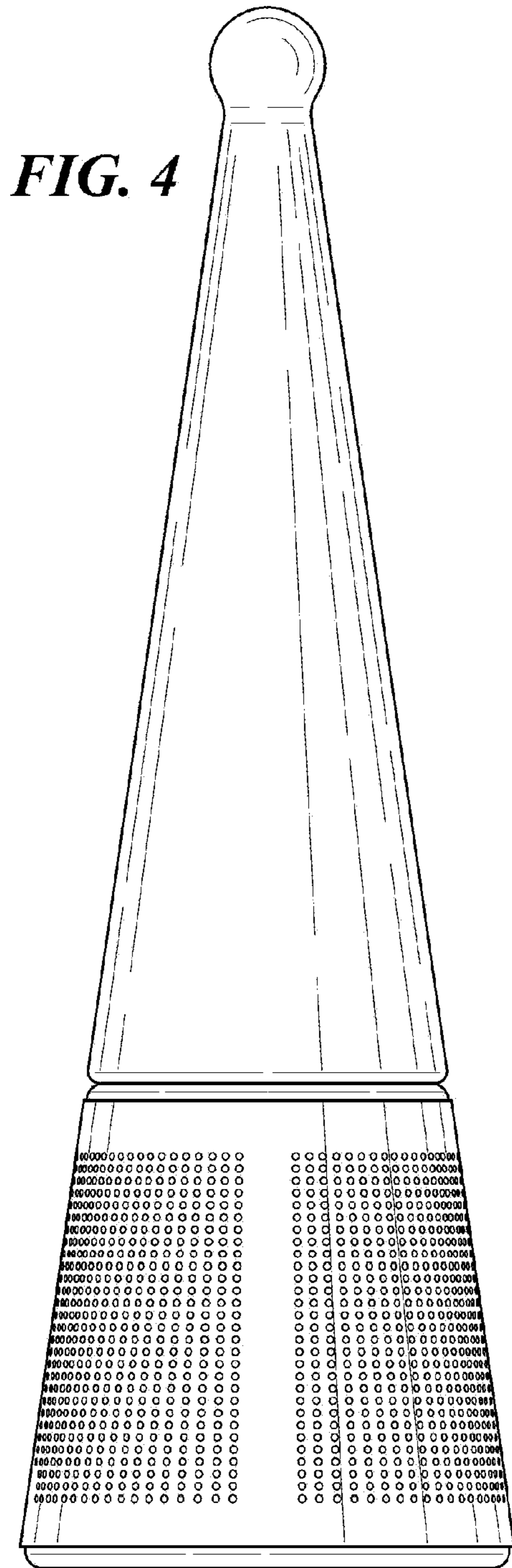


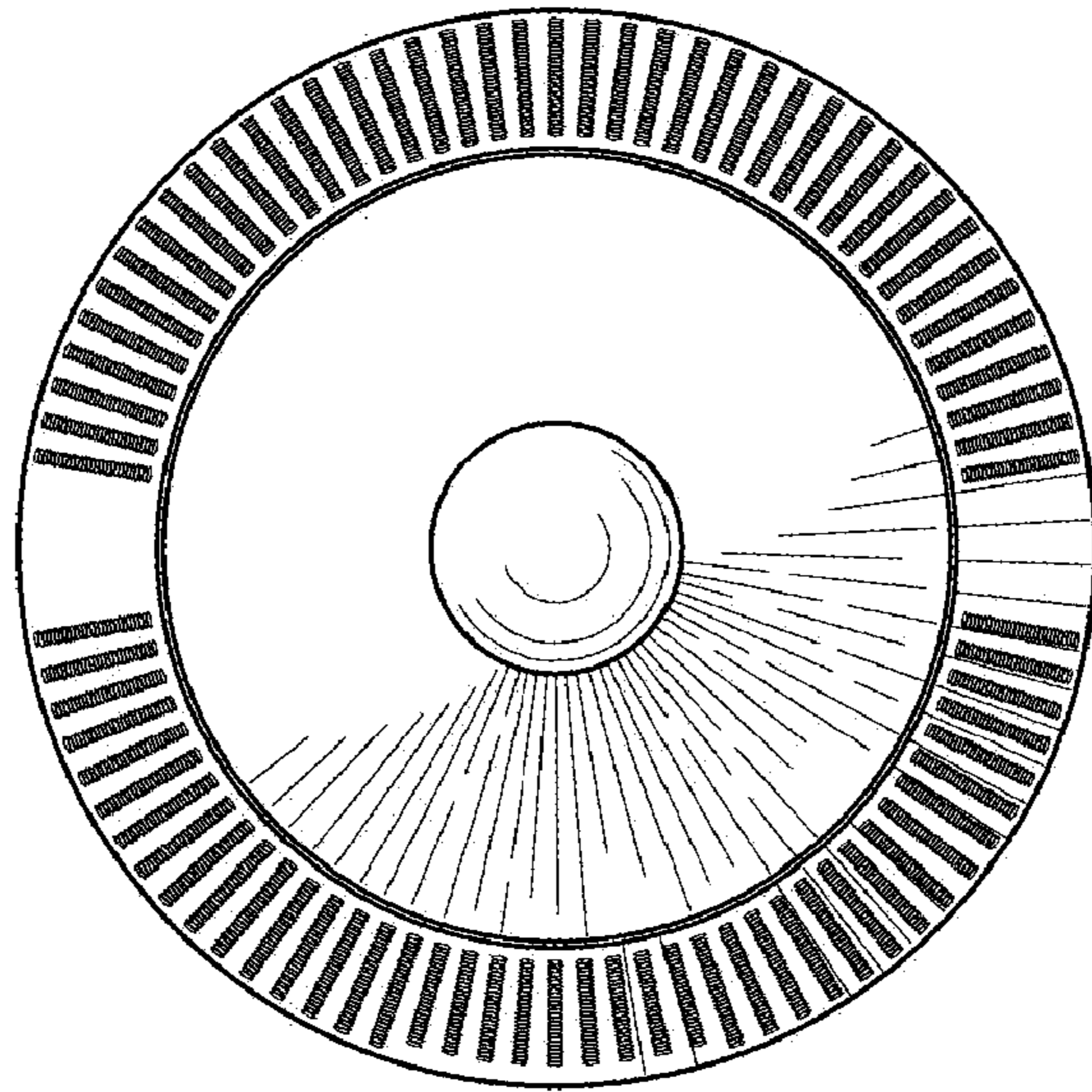
**FIG. 2**



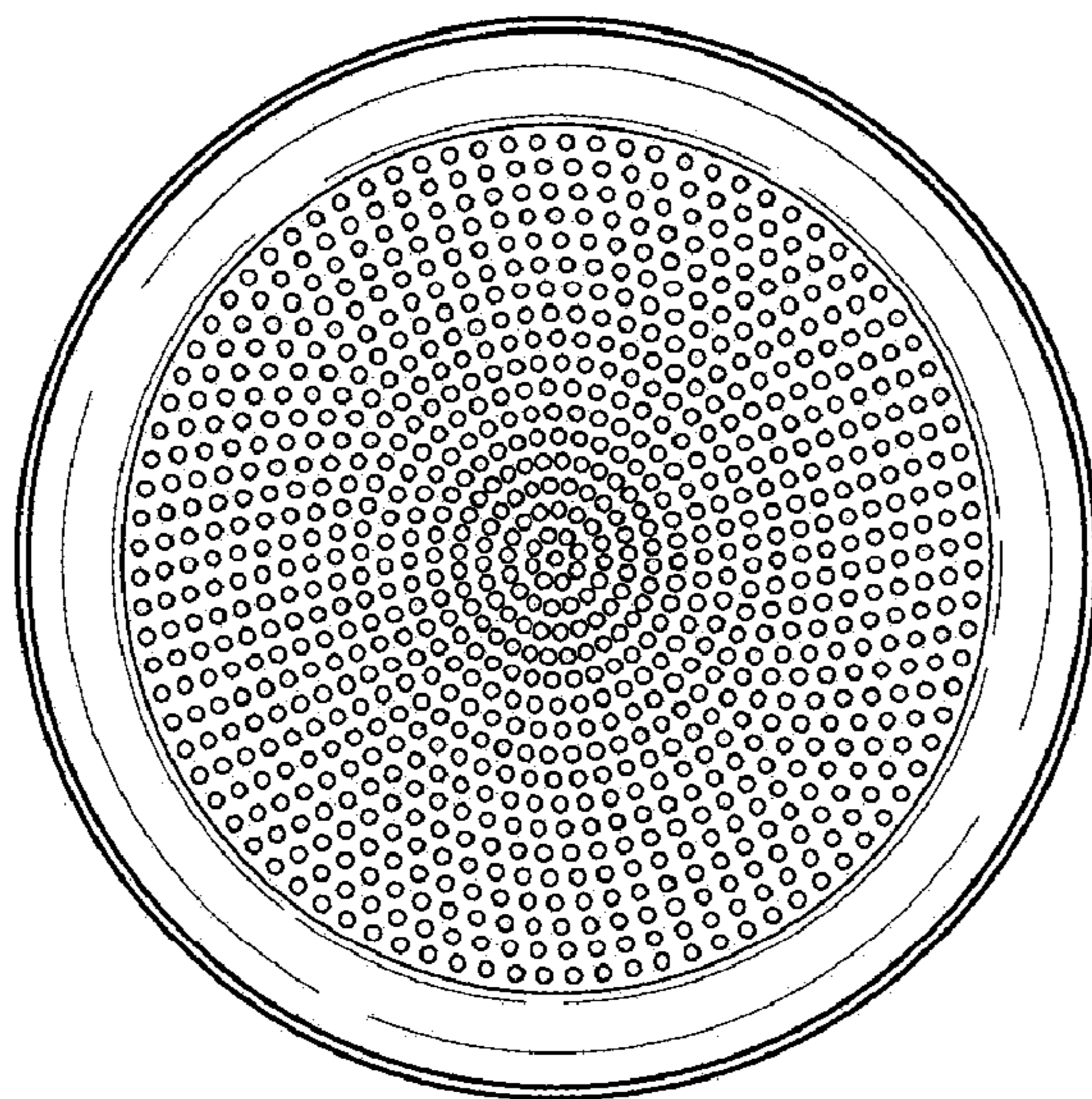
**FIG. 3**





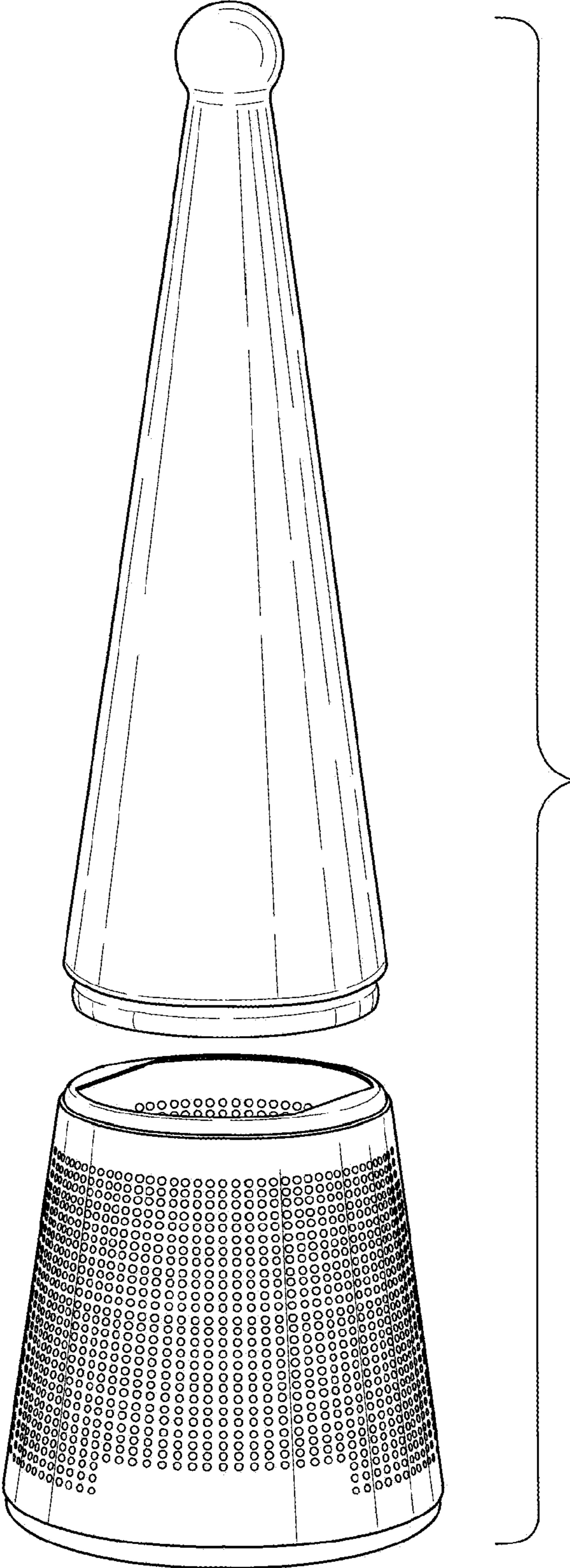


**FIG. 6**



**FIG. 7**

**FIG. 8**



**FIG. 9**

