



US00D613109S

(12) **United States Design Patent**  
**Sanchez et al.**

(10) **Patent No.:** **US D613,109 S**  
(45) **Date of Patent:** **\*\* Apr. 6, 2010**

(54) **EXPANDABLE ONE-PIECE SLEEVE FOR AN ICE CHEST**

(75) Inventors: **Gregory Joseph Sanchez**, Gilbert, AZ (US); **Troy Allen Goins**, Gilbert, AZ (US)

(73) Assignee: **Cooler Concepts, LLC.**, Tempe, AZ (US)

(\*\*) Term: **14 Years**

(21) Appl. No.: **29/337,459**

(22) Filed: **May 21, 2009**

(51) **LOC (9) Cl.** ..... **07-02**

(52) **U.S. Cl.** ..... **D7/392; D7/605**

(58) **Field of Classification Search** ..... D7/392, D7/601, 620, 603, 605, 606, 607, 624.2, 901; D9/711, 430-433; 62/371, 372, 457.7, 530; 206/459.5, 545, 597; 218/388; 220/4.03, 220/212.5, 309.1, 315, 592.03, 677, 703, 220/739, 903

See application file for complete search history.

(56) **References Cited**

**U.S. PATENT DOCUMENTS**

1,693,435	A *	11/1928	Clarke	.....	206/823
3,938,694	A *	2/1976	Archuleta	.....	220/677
3,958,359	A *	5/1976	Doughty	.....	D7/605
4,877,137	A *	10/1989	Govang et al.	.....	206/597
D346,738	S *	5/1994	Kinigakis	.....	D9/711
5,715,962	A *	2/1998	McDonnell	.....	220/4.03
D411,784	S *	7/1999	Houry	.....	D34/19
6,036,047	A *	3/2000	Dobbie	.....	220/592.03
6,050,419	A *	4/2000	Flanagan et al.	.....	206/597
D426,745	S *	6/2000	Bavitz	.....	D7/387
6,145,696	A *	11/2000	Duncan	.....	220/739
6,276,164	B1 *	8/2001	Santa Cruz et al.	.....	62/457.7
6,341,713	B1 *	1/2002	Kilmer	.....	220/694
D467,772	S *	12/2002	Williams	.....	D7/607

D481,266	S *	10/2003	Schilhab	.....	D7/605
D508,826	S *	8/2005	Bidwell et al.	.....	D7/605
D512,605	S *	12/2005	Estes	.....	D7/606
D514,897	S *	2/2006	Hoffman	.....	D7/624.2
7,032,753	B2 *	4/2006	Purvis	.....	206/459.5
D521,810	S *	5/2006	Estes	.....	D7/606
D557,565	S *	12/2007	Van Oosten	.....	D7/605
7,373,962	B2 *	5/2008	Oubichon	.....	220/315
D587,972	S *	3/2009	Dorisca et al.	.....	D7/605
2005/0279123	A1 *	12/2005	Maldonado et al.	.....	62/457.7
2006/0243730	A1 *	11/2006	Oubichon	.....	220/315
2006/0289428	A1 *	12/2006	Longua	.....	219/388
2009/0194172	A1 *	8/2009	Lymn et al.	.....	206/459.5

\* cited by examiner

*Primary Examiner*—Philip S Hyder

*Assistant Examiner*—Cynthia M Chin

(74) *Attorney, Agent, or Firm*—The von Hellens Law Firm, Ltd.

(57) **CLAIM**

The ornamental design for an expandable one-piece sleeve for an ice chest, as shown and described.

**DESCRIPTION**

FIG. 1 is an isometric view from the front, left and top of an expandable one-piece sleeve for an ice chest showing our new design; the broken lines depicting the ice chest form no part of my design;

FIG. 2 is an isometric view of the front, left and top thereof, the extended corner is intended to depict the expandability of the sleeve;

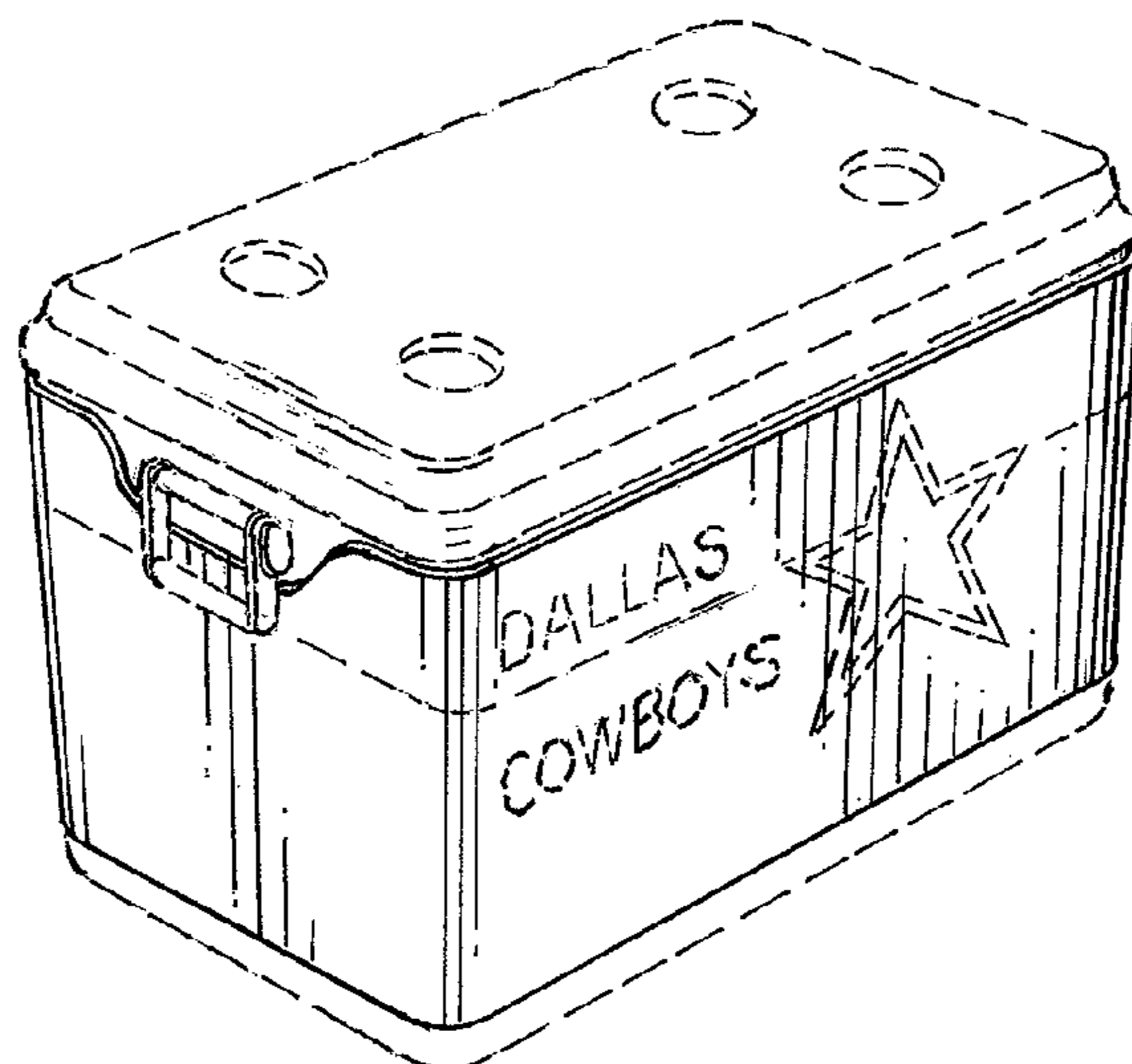
FIG. 3 is a top view thereof;

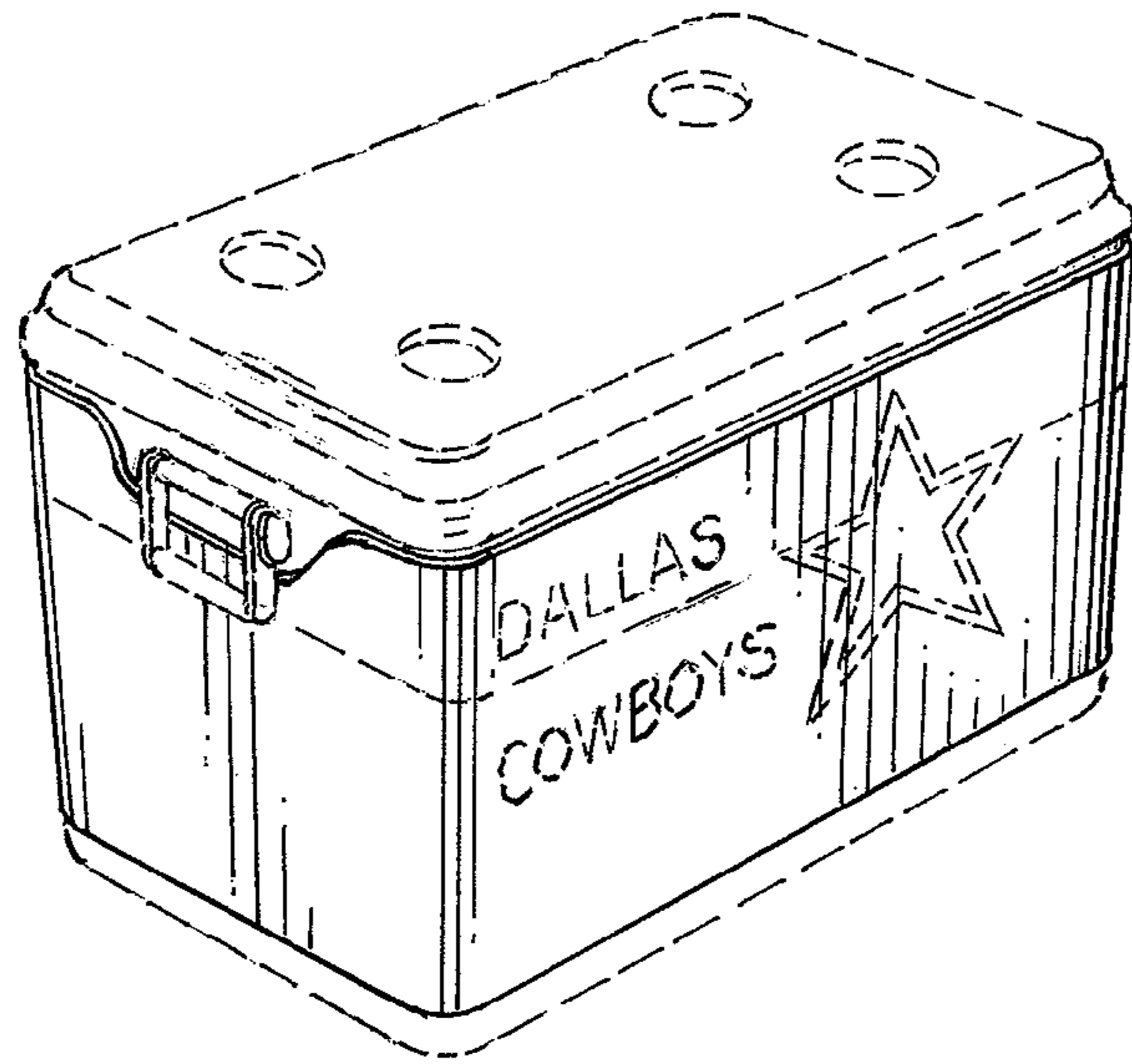
FIG. 4 is a bottom view thereof;

FIG. 5 is a left side elevational view thereof, the right side elevational view is a mirror image; and,

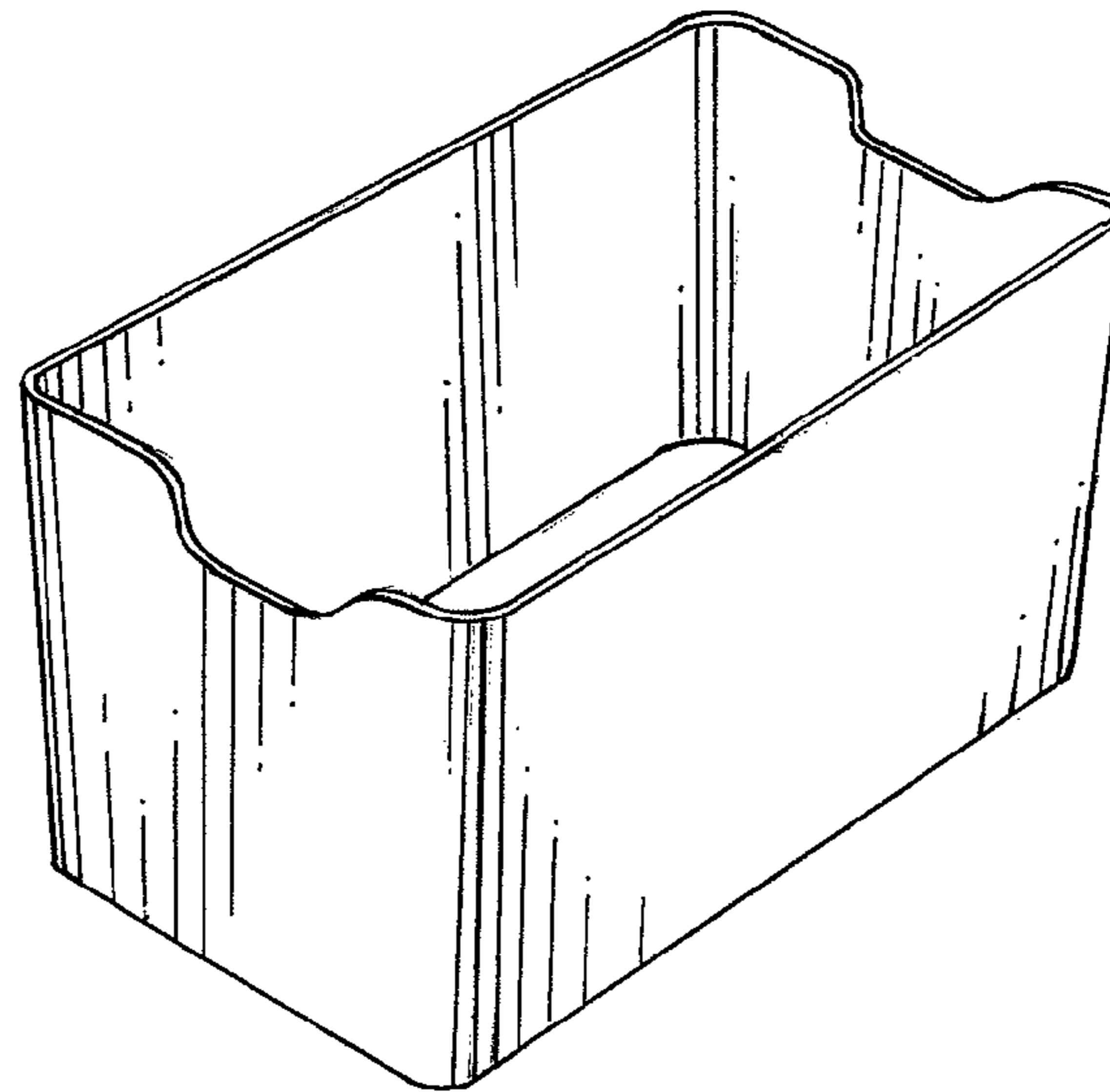
FIG. 6 is a front elevational view thereof, the rear elevational view is a mirror image.

**1 Claim, 2 Drawing Sheets**

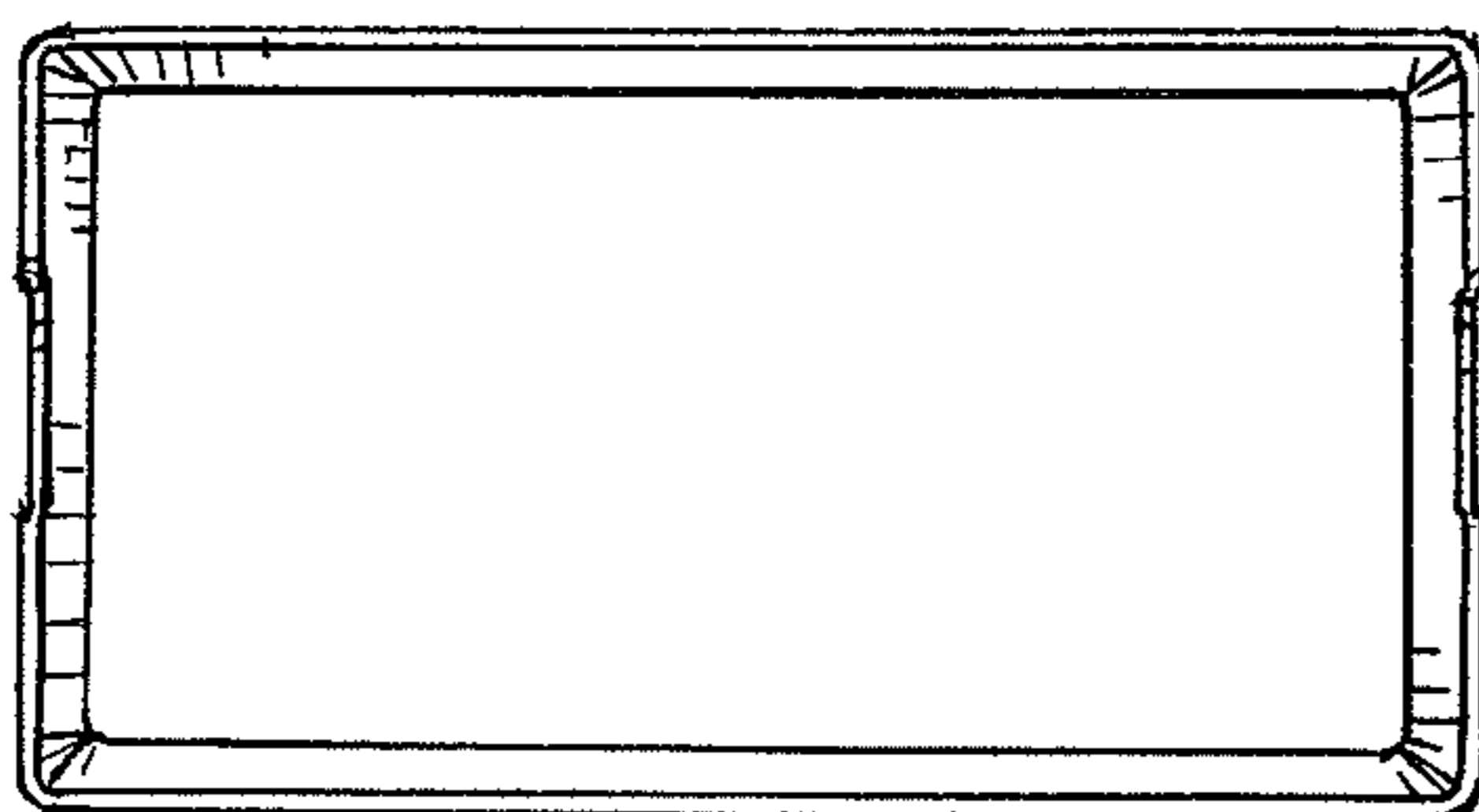




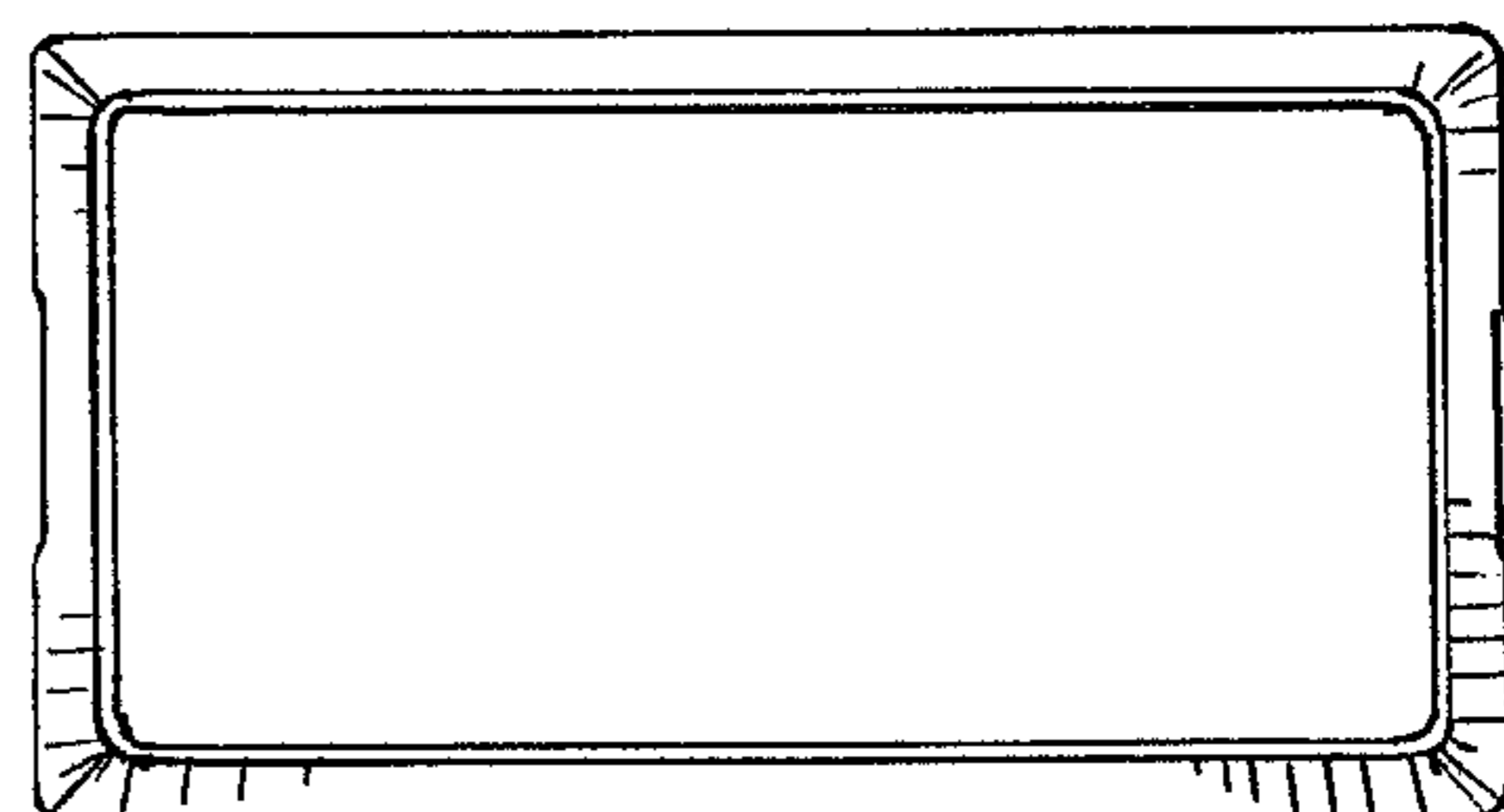
*Fig. 1*



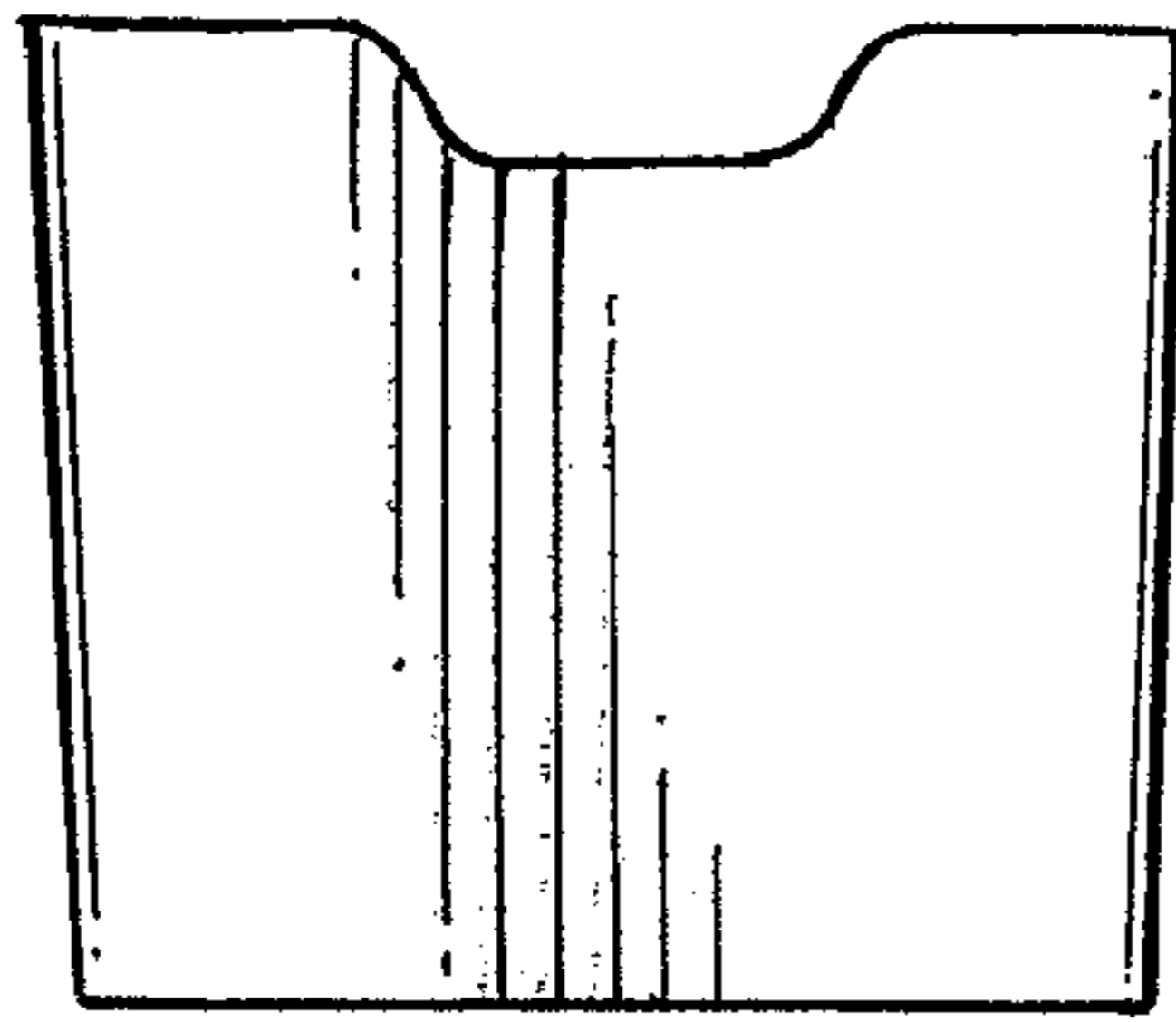
*Fig. 2*



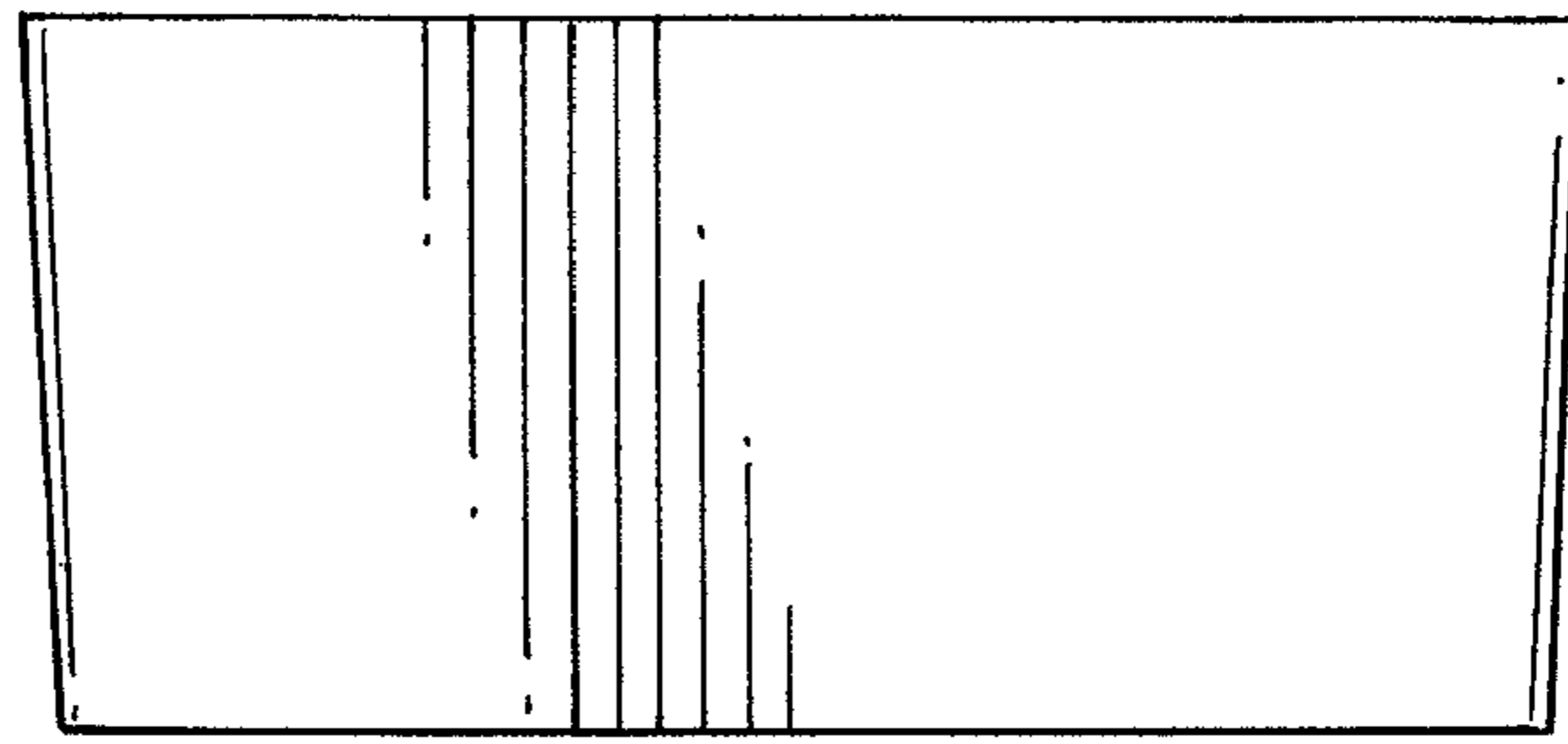
*Fig. 3*



*Fig. 4*



*Fig. 5*



*Fig. 6*