



US00D613101S

(12) **United States Design Patent**
Hardy

(10) **Patent No.:** **US D613,101 S**
(45) **Date of Patent:** **** Apr. 6, 2010**

(54) **DISPENSER**

D584,548 S * 1/2009 Parker et al. D6/515

(75) Inventor: **Stephen N. Hardy**, Wadsworth, OH
(US)

OTHER PUBLICATIONS
U.S. Appl. No. 29/337,012, filed May 13, 2009, Hardy.

(73) Assignee: **RTC Industries, Inc.**, Rolling Meadows,
IL (US)

* cited by examiner

(**) Term: **14 Years**

Primary Examiner—Brian N Vinson
(74) *Attorney, Agent, or Firm*—Banner & Witcoff, Ltd.

(21) Appl. No.: **29/328,312**

(57) **CLAIM**

(22) Filed: **Nov. 21, 2008**

The ornamental design for a dispenser, as shown and described.

Related U.S. Application Data

DESCRIPTION

(63) Continuation of application No. 11/760,196, filed on Jun. 8, 2007, which is a continuation-in-part of application No. 11/411,761, filed on Apr. 25, 2006, application No. 29/328,312, which is a continuation of application No. 11/411,761.

FIG. 1 is a front right perspective view of a dispenser showing my new design;

FIG. 2 is a left side view thereof;

FIG. 3 is a right side view thereof;

FIG. 4 is a front view thereof;

FIG. 5 is a rear view thereof;

FIG. 6 is a top view thereof;

FIG. 7 is a bottom view thereof;

FIG. 8 is a front right perspective view of a dispenser shown in surrounding environmental structure; and,

FIG. 9 is an enlarged fragmentary view of the portion identified by the arrow and letter "A" in FIG. 1.

The dash-dotted broken line showing immediately adjacent to the shaded area represents an unclaimed boundary of the design. The dotted line showing of the remainder of the dispenser is for illustrative purposes only and forms no part of the claimed design. The arrow and letter "A" in FIG. 1 identify the portion shown in FIG. 9 and form no part of the claimed design.

(51) **LOC (9) Cl.** **20-02**

(52) **U.S. Cl.** **D6/515**

(58) **Field of Classification Search** D6/515,
D6/517; 211/13.1, 16, 44, 49.1, 59.3
See application file for complete search history.

(56) **References Cited**

U.S. PATENT DOCUMENTS

- 5,562,217 A * 10/1996 Salveson et al. 211/59.3
- 5,634,564 A * 6/1997 Spamer et al. 211/59.3
- D419,804 S * 2/2000 Reitman D6/517
- 6,142,317 A * 11/2000 Merl 211/59.3
- 6,889,855 B2 * 5/2005 Nagel 211/59.3
- 7,195,123 B2 * 3/2007 Roslof et al. 211/59.3
- D545,096 S * 6/2007 Simpson et al. D6/515
- 7,293,663 B2 * 11/2007 Lavery, Jr. 211/59.3

1 Claim, 6 Drawing Sheets

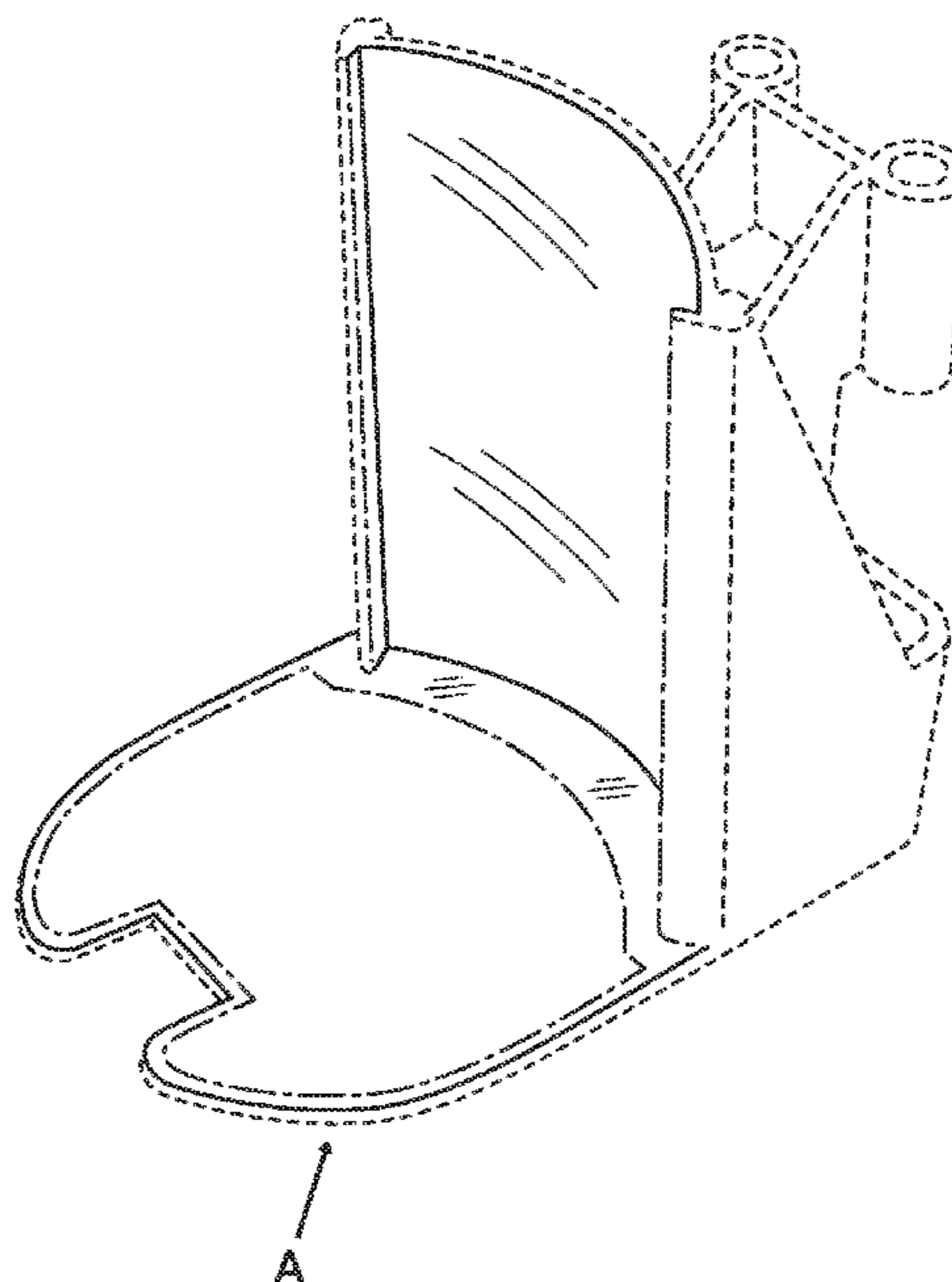

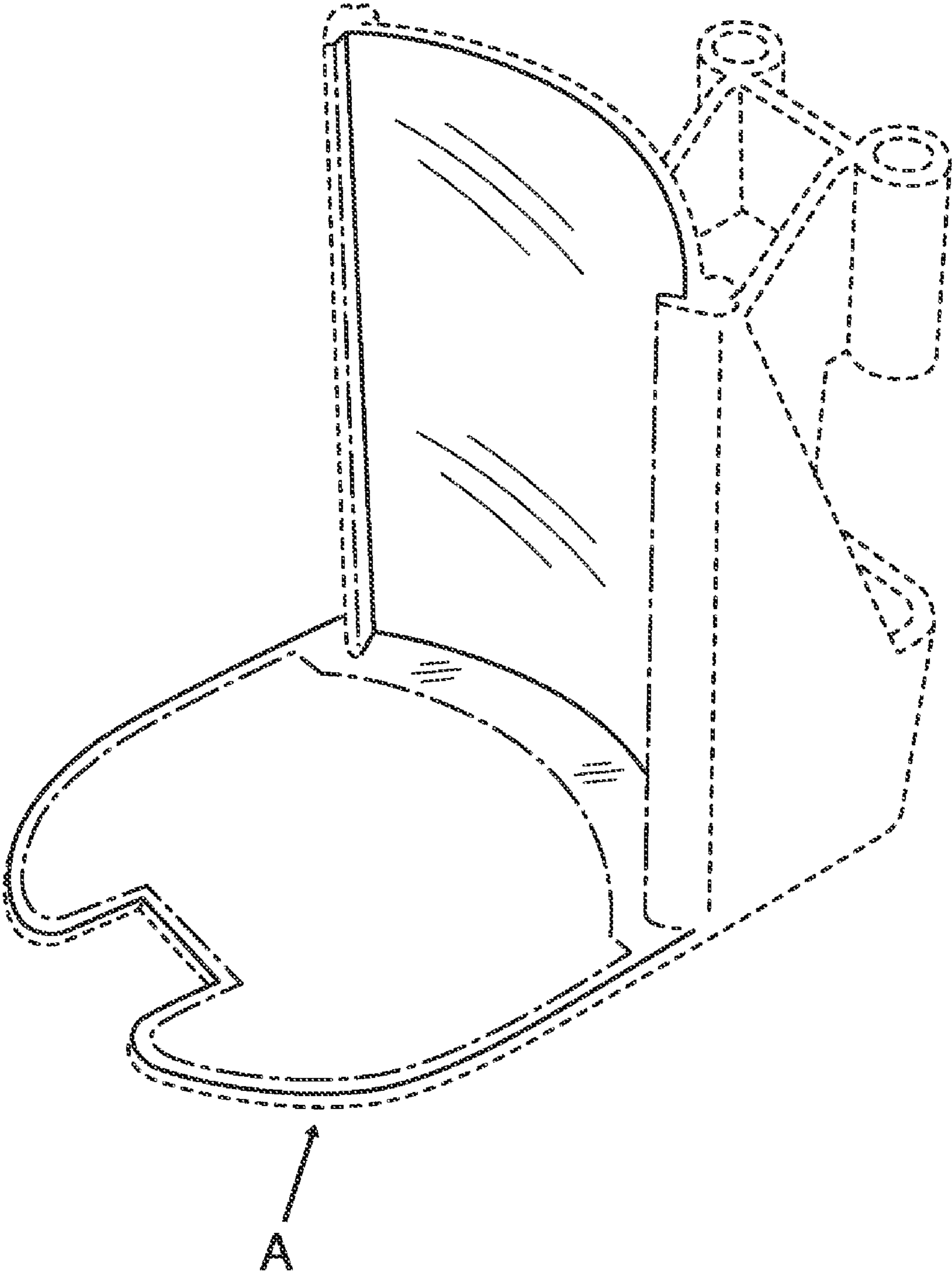

FIG. 1

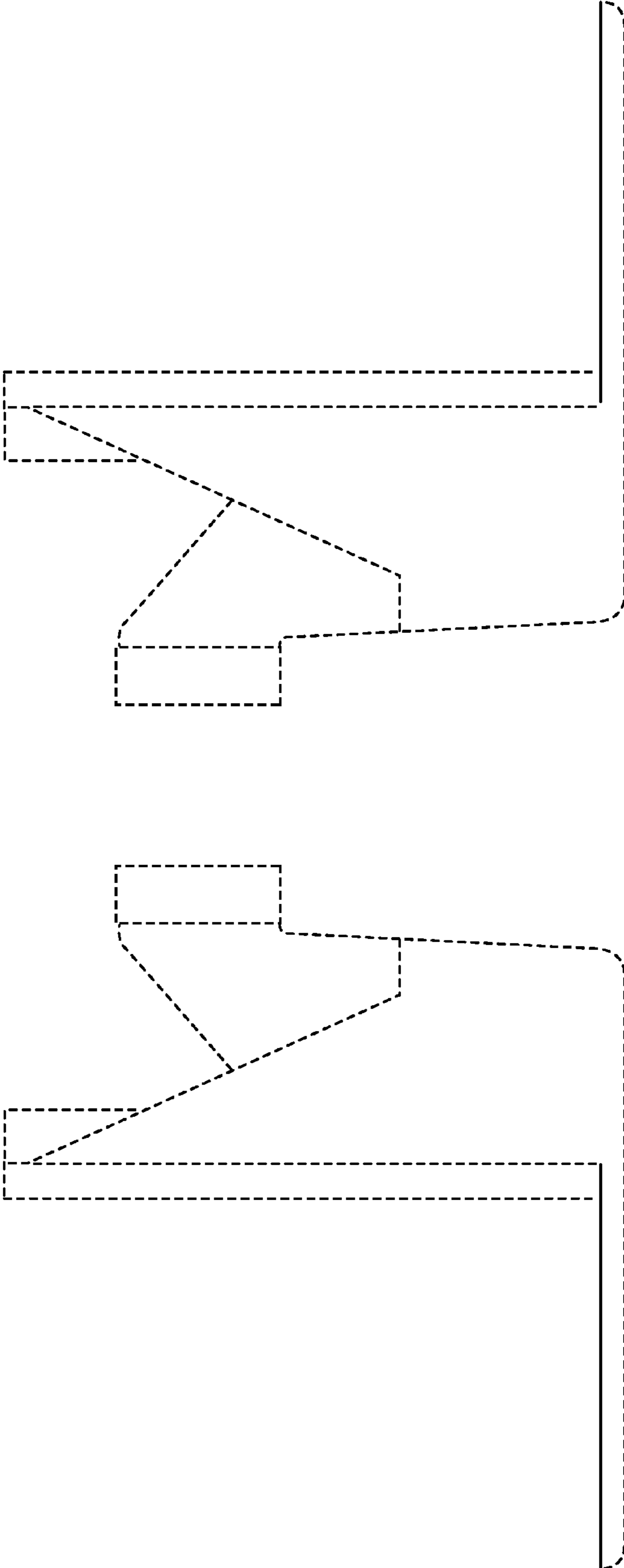

FIG. 2

FIG. 3

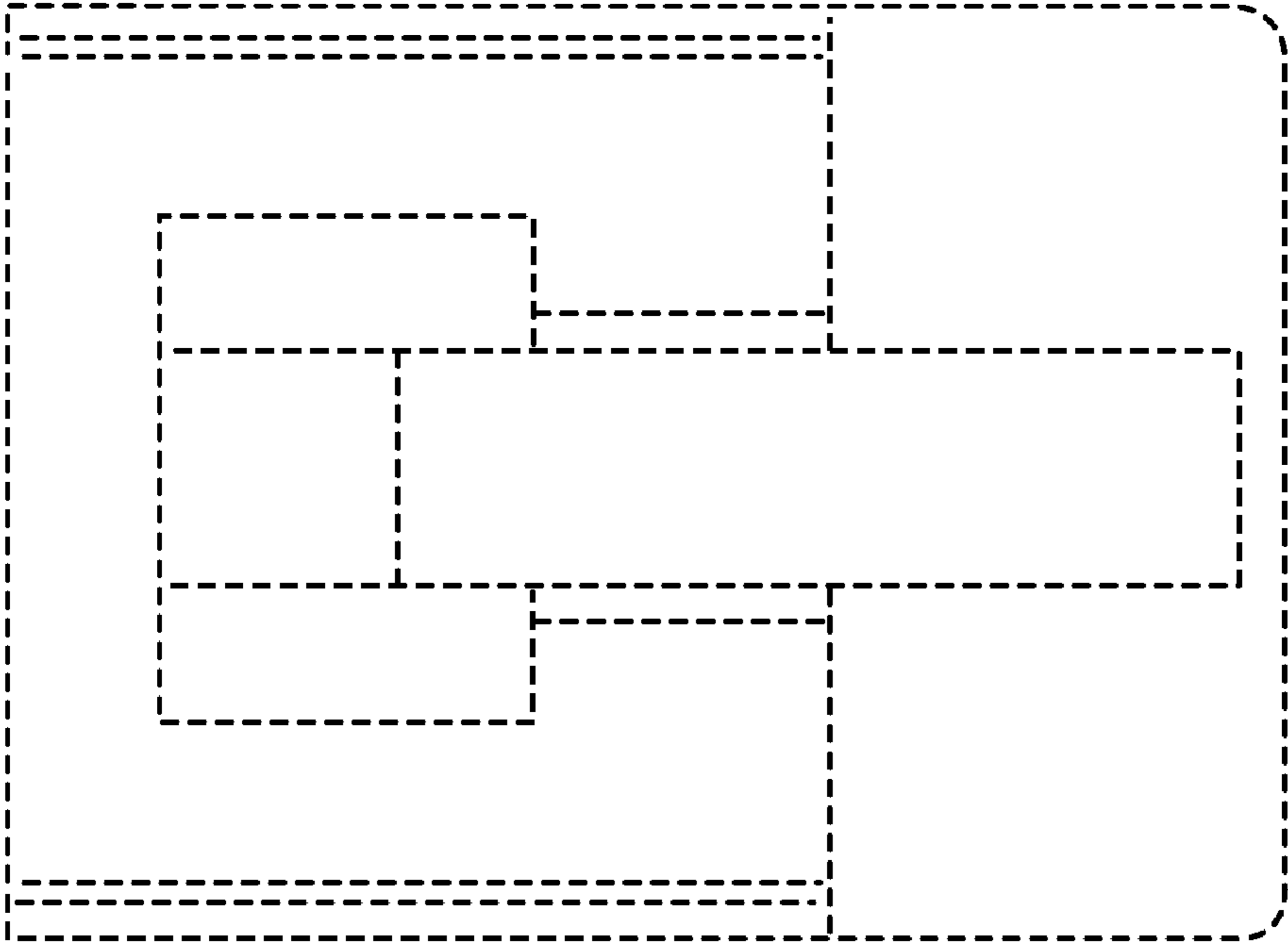

FIG. 5

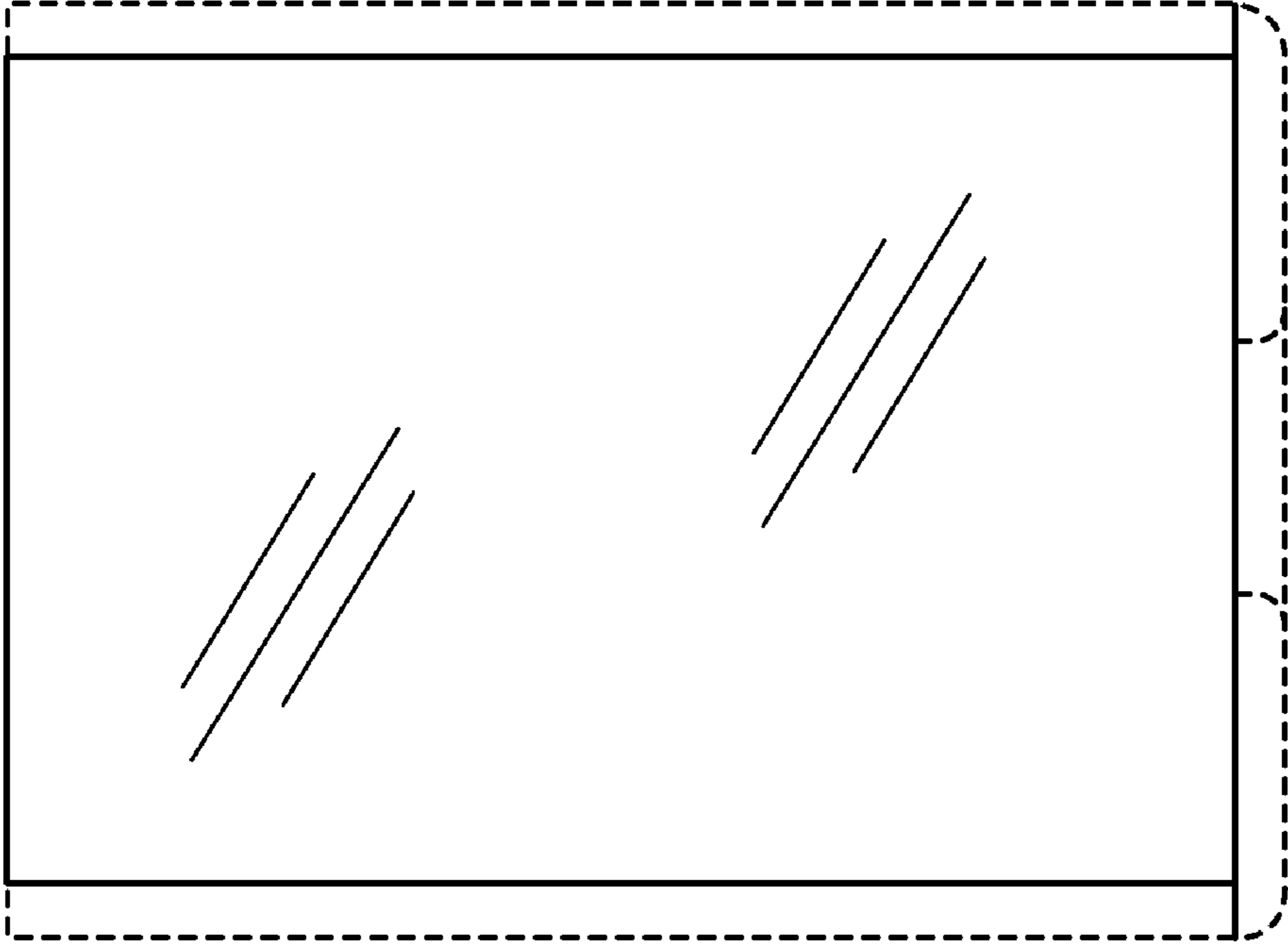

FIG. 4

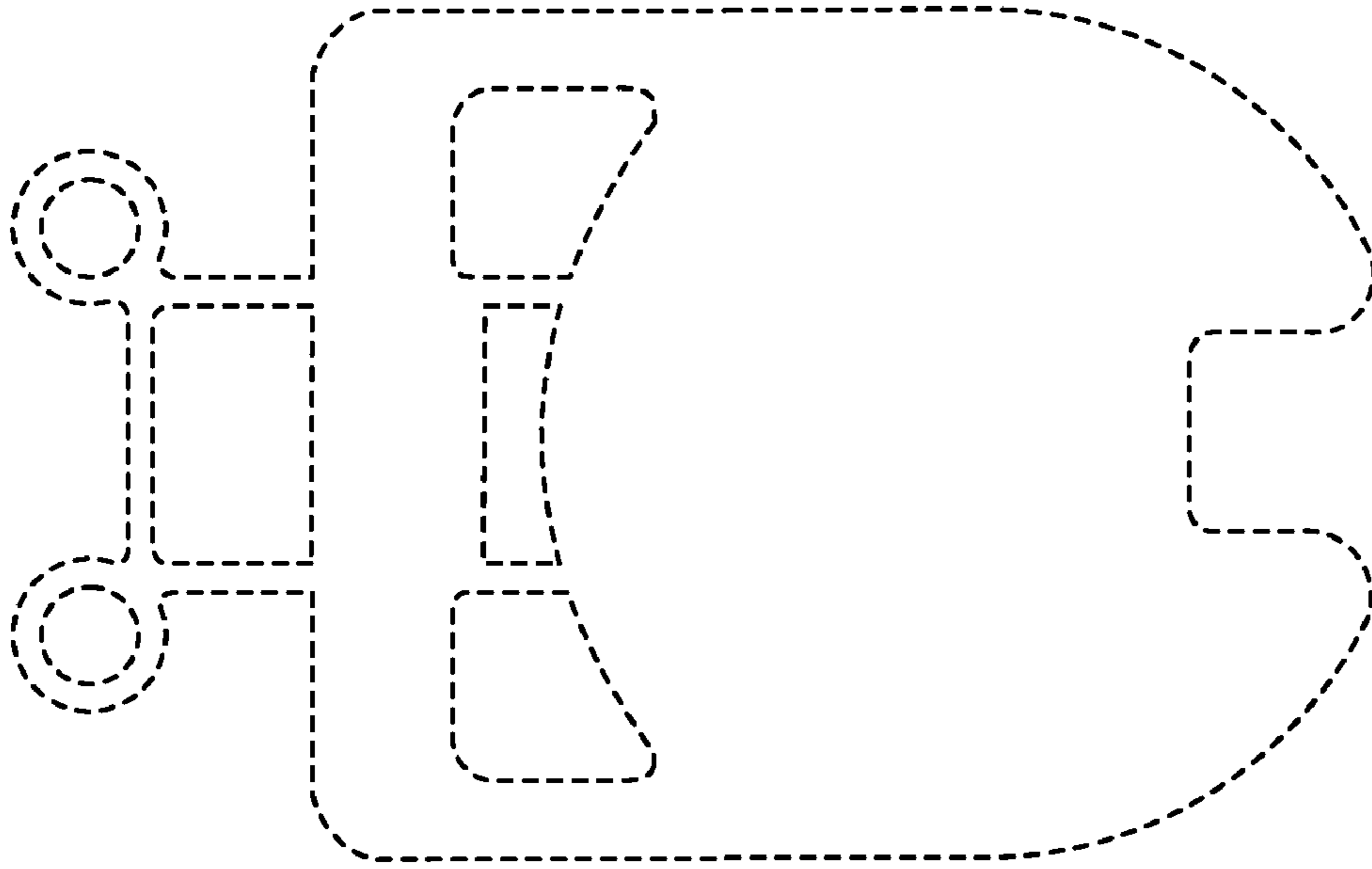

FIG. 7

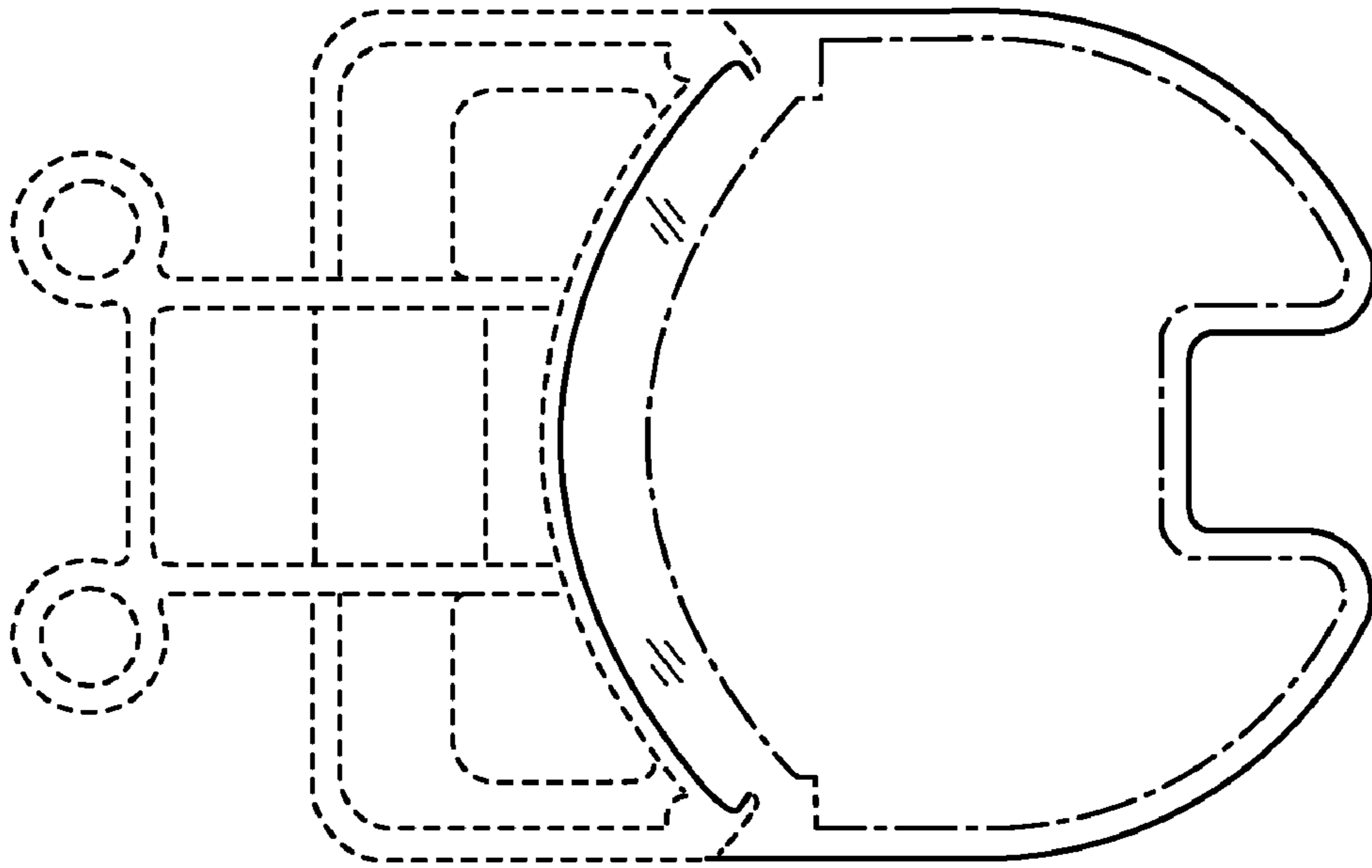

FIG. 6

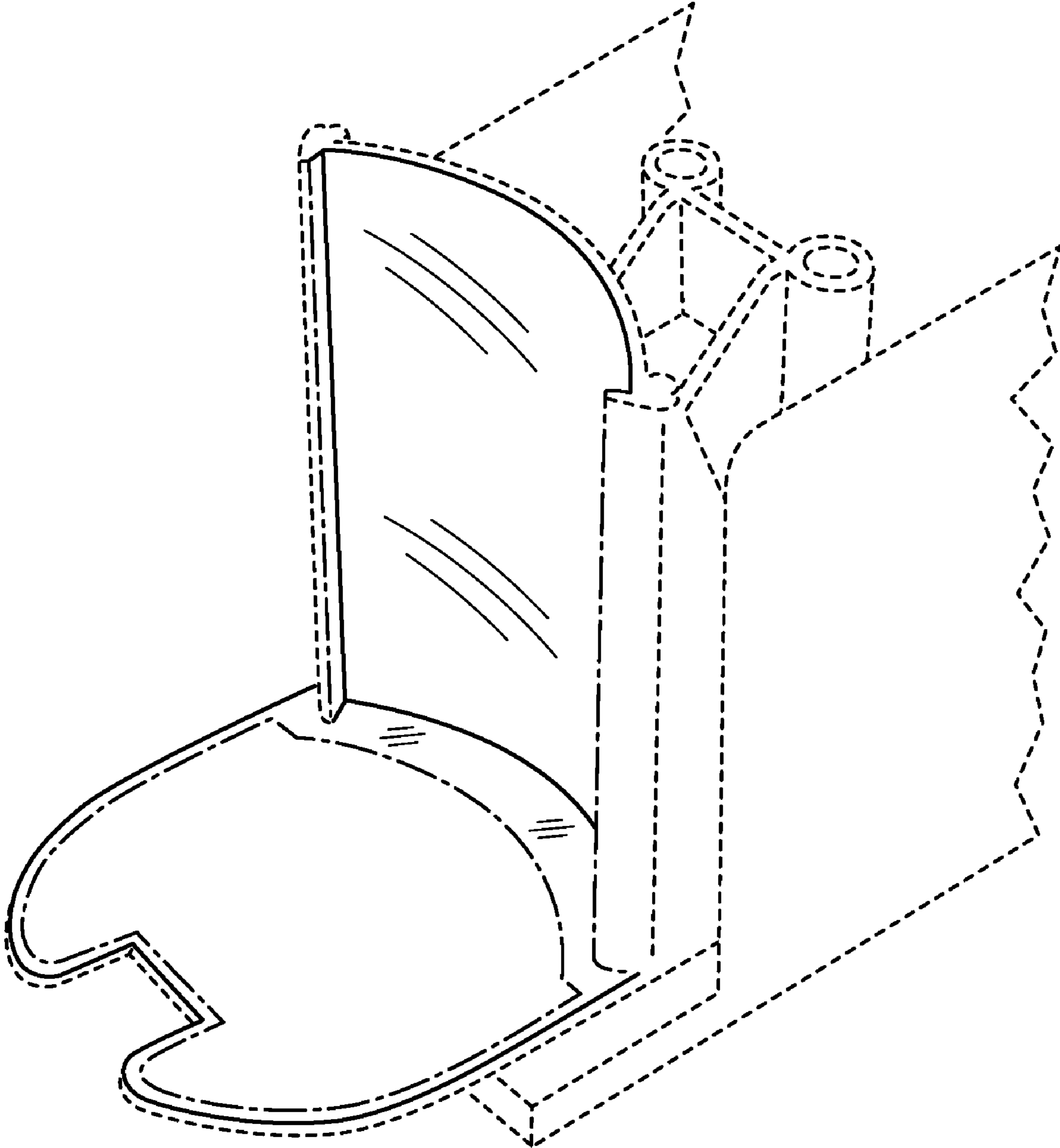

FIG. 8

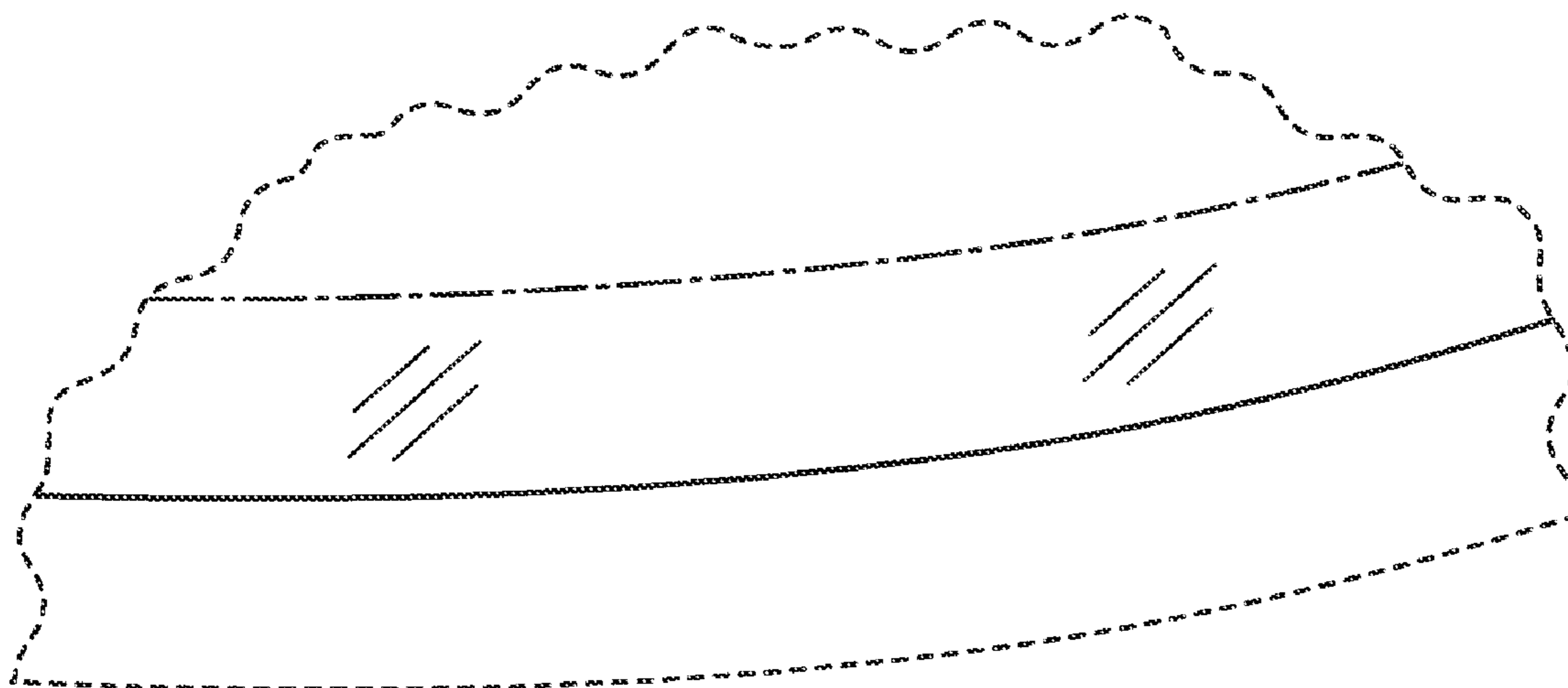

FIG. 9