



US00D612946S

(12) **United States Design Patent**  
**Ferri**

(10) **Patent No.:** **US D612,946 S**  
(45) **Date of Patent:** **\*\* \*Mar. 30, 2010**

(54) **FOOT-THERAPY AND TOE-ALIGNING DEVICE**

(75) Inventor: **Frederic Ferri**, Ann Arbor, MI (US)

(73) Assignee: **FennF, LLC**, Ann Arbor, MI (US)

(\*\*) Term: **14 Years**

(21) Appl. No.: **29/301,300**

(22) Filed: **Feb. 21, 2008**

(51) **LOC (9) Cl.** ..... **24-02**

(52) **U.S. Cl.** ..... **D24/200**

(58) **Field of Classification Search** ..... D24/200,  
D24/212-214; D21/680; 601/23, 27, 29-35,  
601/49-50, 56-57, 84-86, 93, 97-98, 101,  
601/40, 118, 131, 135-138; 482/44, 47,  
482/59-50, 97

See application file for complete search history.

(56) **References Cited**

**U.S. PATENT DOCUMENTS**

276,558 A 5/1883 Brown, Jr.

(Continued)

**FOREIGN PATENT DOCUMENTS**

DE 276558 7/1914

(Continued)

**OTHER PUBLICATIONS**

Notice of Allowance for U.S. Appl. No. 11/541,067.

Issue Notification for U.S. Appl. No. 11/541,067.

“Yoga Toes”, 1 p., <<http://www.yogapro.com>>, 2008.

“Ms. Pedicure Toe Separator”, 1 page, <<http://store.facevaluesonline.com>>, 2008.

“Genki-kun One Step”, 7 pages, <<http://www.dr-1.co.jp>>, 2008.

“Toe Stretchers Strengthening Premium Toe Trainers”, 7 pages, <<http://www.healiohealth.com>> Mar. 24, 2008.

Toe Flexers (C7315), 1 page, <[www.harrietcarter.com](http://www.harrietcarter.com)>, 2008.

“Genki-kun One-Step”, 5 pages, <<http://www.dr-l.co.jp/e/onestep.html>>.

“Correct Toes”, 3 pages, <<http://nwfootankle.com/home/toes>>, 2009.

*Primary Examiner*—Cathron C Brooks

*Assistant Examiner*—Melanie Levy

(74) *Attorney, Agent, or Firm*—Tope-McKay & Associates; Marcus Risso

(57) **CLAIM**

The ornamental design for a foot therapy and toe-aligning device, as shown and described.

**DESCRIPTION**

FIG. 1 is a top, isometric view of a foot-therapy and toe-aligning device;

FIG. 2 is a bottom, isometric view of a foot-therapy and toe-aligning device;

FIG. 3 is a top view of a foot-therapy and toe-aligning device;

FIG. 4 is a bottom view of a foot-therapy and toe-aligning device;

FIG. 5 is a front view of a foot-therapy and toe-aligning device;

FIG. 6 is a rear view of a foot-therapy and toe-aligning device;

FIG. 7 is a left, side-view of a foot-therapy and toe-aligning device; and,

FIG. 8 is a right, side-view of a foot-therapy and toe-aligning device.

The broken lines shown in the drawings represent unclaimed portions of the design and form no part thereof.

**1 Claim, 8 Drawing Sheets**

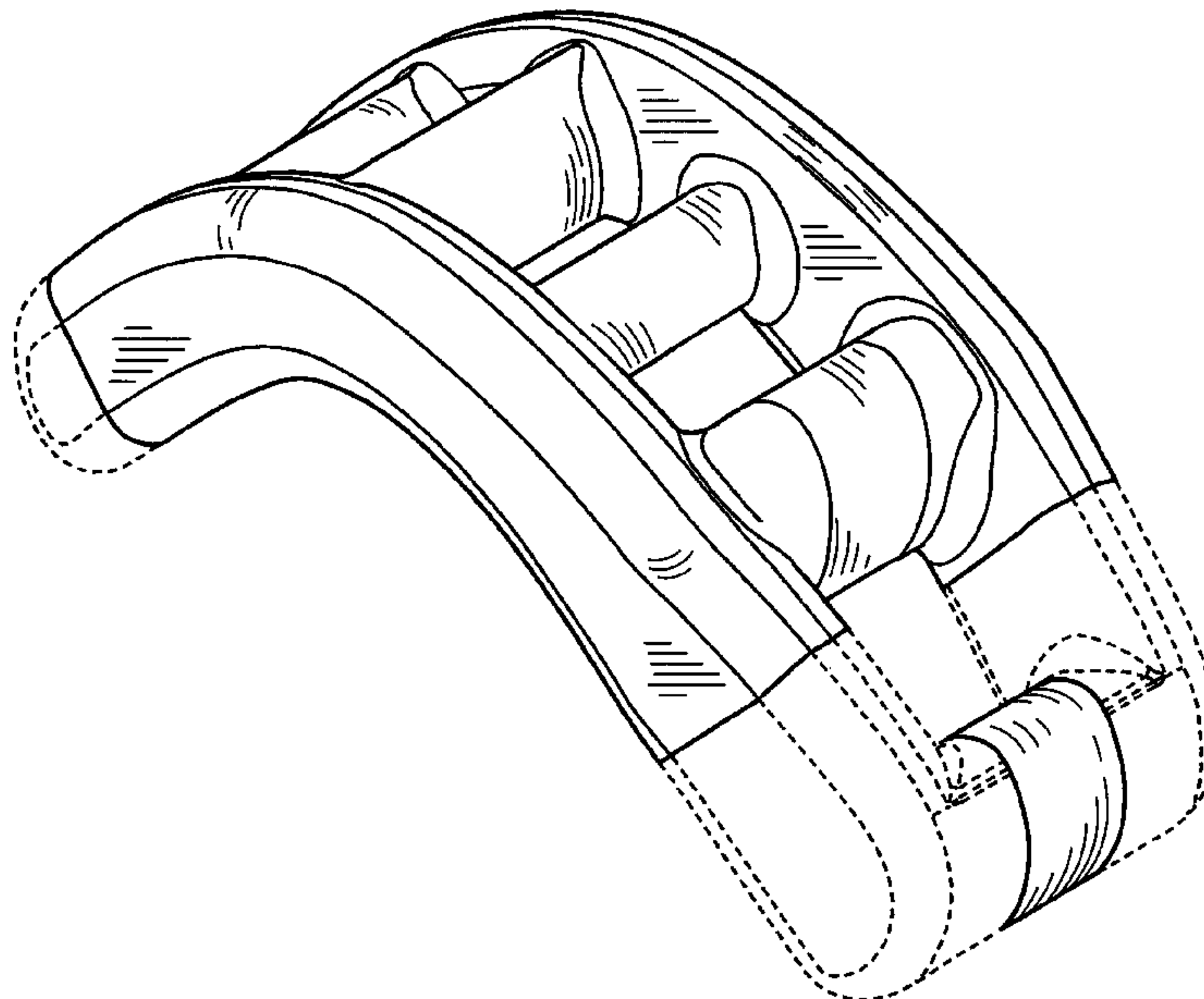

# US D612,946 S

## U.S. PATENT DOCUMENTS

365,572	A	6/1887	Boomer	
445,921	A	2/1891	Burlingame	
525,059	A	8/1894	Ray et al.	
633,422	A	8/1899	Burns et al.	
1,095,213	A	5/1914	Johnson	
1,098,397	A	6/1914	Pacorella	
1,349,085	A	8/1920	Mouse	
1,402,375	A	1/1922	Parisi	
1,867,679	A	7/1932	Riehle, et al.	
2,153,493	A	4/1939	Yakimchick	
2,223,204	A	11/1940	Carmichael	
2,286,089	A	6/1942	Harris	
2,335,665	A	11/1943	Goldmerstein	
2,471,997	A	5/1949	Baltor	
2,506,308	A	5/1950	Maynier	
2,517,232	A	8/1950	Patulski	
2,531,851	A	11/1950	Kiwad	
2,575,867	A	11/1951	Ferri	
2,575,868	A	11/1951	Ferri	
2,595,640	A	5/1952	Christopoulos	
2,740,207	A	4/1956	Starensier	
2,751,693	A	6/1956	Baker	
2,808,662	A	10/1957	Webb	
2,947,095	A	8/1960	Miyachi	
2,949,112	A	8/1960	Murray	
3,011,281	A	12/1961	King	
3,049,120	A	8/1962	Marcus	
3,088,458	A *	5/1963	Stewart ..... 601/122	
3,099,884	A	8/1963	Kixmiller et al.	
3,128,763	A	4/1964	Langenfeld et al.	
3,275,002	A	9/1966	Scholl	
3,299,893	A	1/1967	Collina	
3,581,740	A	6/1971	Sherbourne	
3,724,458	A	4/1973	Piper	
3,967,390	A	7/1976	Anfruns	
4,017,987	A	4/1977	Perez, Jr. et al.	
4,207,880	A	6/1980	Zinkovich	
4,263,902	A	4/1981	Dieterich	
D260,047	S	8/1981	Heinz	
4,300,294	A	11/1981	Riecken	
D271,156	S	11/1983	Williamson	
4,419,839	A	12/1983	Wong	
4,821,431	A	4/1989	Rieffel	
D306,084	S	2/1990	Volz et al.	
4,914,837	A	4/1990	Rieffel	
4,936,300	A	6/1990	Funatogawa	
5,039,093	A	8/1991	Collier	
5,062,625	A	11/1991	Vonk	
5,076,263	A	12/1991	Funatogawa	
5,087,036	A	2/1992	Cooper	
D325,968	S *	5/1992	Nofsinger ..... D21/685	
5,136,911	A	8/1992	Wyss	
5,327,918	A	7/1994	Stewart et al.	

5,374,226	A	12/1994	Grahm	
5,466,202	A	11/1995	Stern	
5,523,734	A	6/1996	Beck et al.	
5,702,354	A *	12/1997	DeSpain et al. .... 601/27	
5,723,785	A	3/1998	Manning	
5,749,377	A	5/1998	Desario	
5,813,078	A	9/1998	Hogan, Sr.	
5,870,837	A	2/1999	Poulos	
5,893,221	A	4/1999	Weissman et al.	
5,946,823	A	9/1999	Yates	
D415,858	S	10/1999	Funatogawa	
D420,785	S	2/2000	Perez	
D428,673	S	7/2000	Ikeda	
6,151,801	A	11/2000	Frederiksen et al.	
D439,704	S	3/2001	Ikeda	
6,226,893	B1	5/2001	Schlamp et al.	
6,228,001	B1	5/2001	Johnson et al.	
6,238,357	B1	5/2001	Kawaguchi et al.	
6,298,580	B1	10/2001	Tadayon	
6,318,373	B1	11/2001	Kasahara	
6,352,096	B1	3/2002	Walsh	
6,481,443	B1	11/2002	Moore-Johnson et al.	
D476,147	S	6/2003	Campbell	
6,625,904	B1	9/2003	Frederiksen et al.	
6,629,943	B1	10/2003	Schroder	
D481,828	S	11/2003	Goldberg et al.	
6,678,971	B2	1/2004	Brooks	
6,817,967	B1	11/2004	Ott et al.	
6,941,954	B1	9/2005	Belcher	
7,322,915	B2	1/2008	Ferri	
D600,818	S	9/2009	Yang	
2003/0029056	A1	2/2003	Frederiksen et al.	
2009/0093345	A1	4/2009	Findeisen	

## FOREIGN PATENT DOCUMENTS

DE	1079504	4/1960
DE	1881215	10/1963
DE	3049528	7/1982
DE	3530511	3/1987
DE	29606182	9/1996
DE	10154185	5/2003
FR	1095213	5/1955
GB	155180	12/1920
GB	246375	1/1926
GB	365572	7/1930
GB	445921	4/1936
GB	525059	8/1940
GB	811791	4/1959
GB	2378891	2/2003
JP	1-250257	10/1989
JP	1250257	10/1989
WO	WO 95/04512	2/1995
WO	WO 01/91674	12/2001

\* cited by examiner

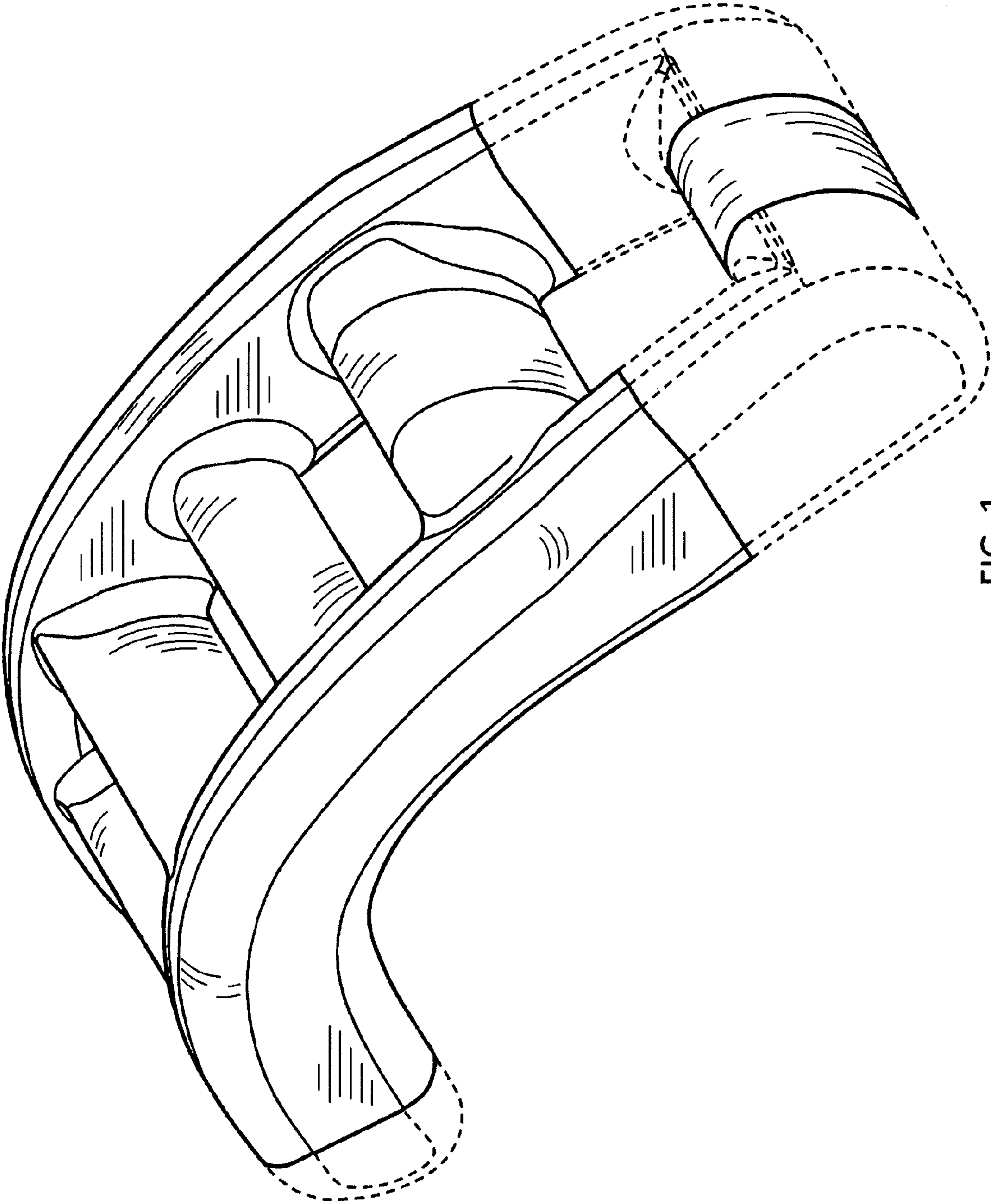

FIG. 1



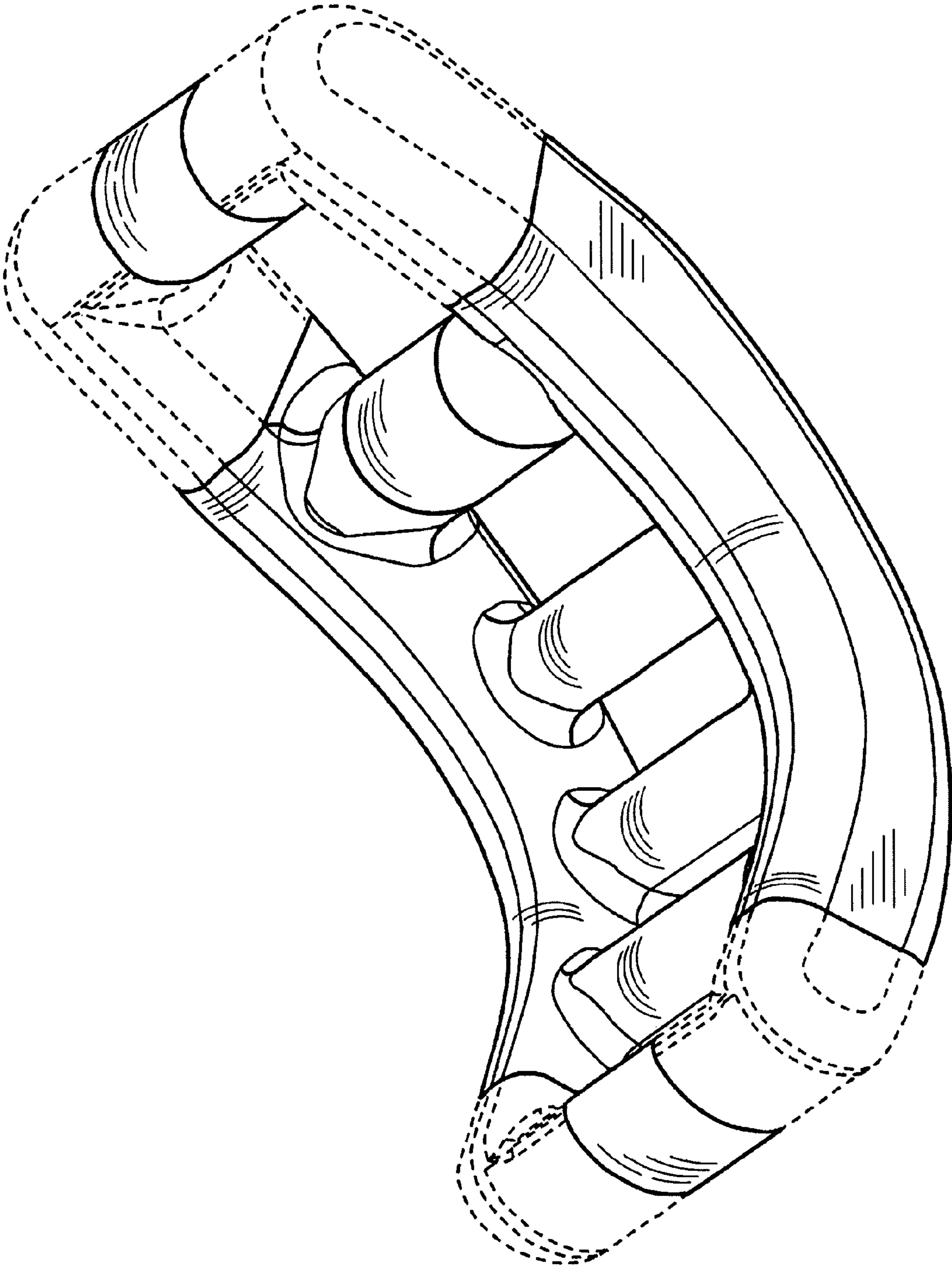

FIG. 2

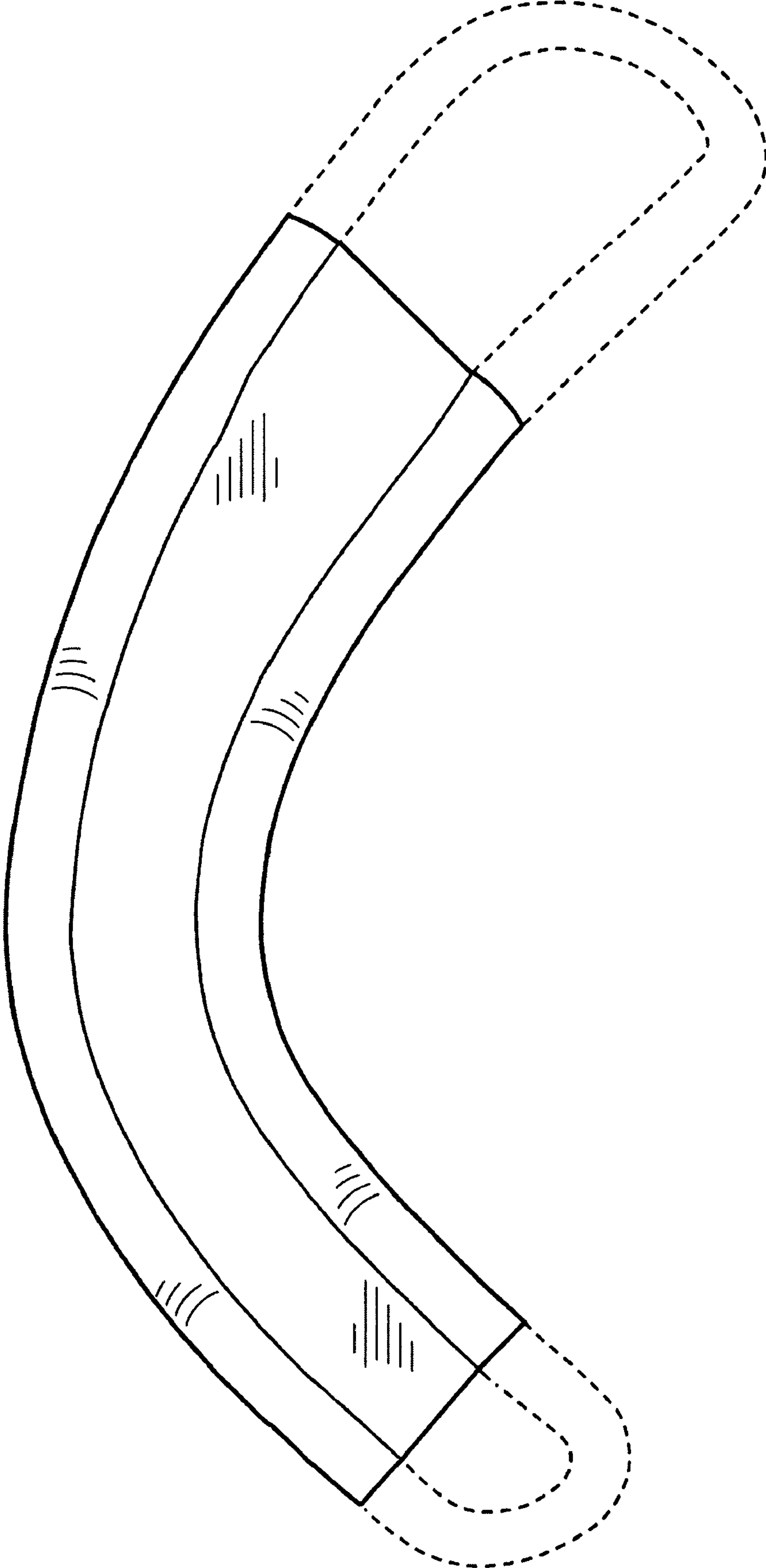

FIG. 3

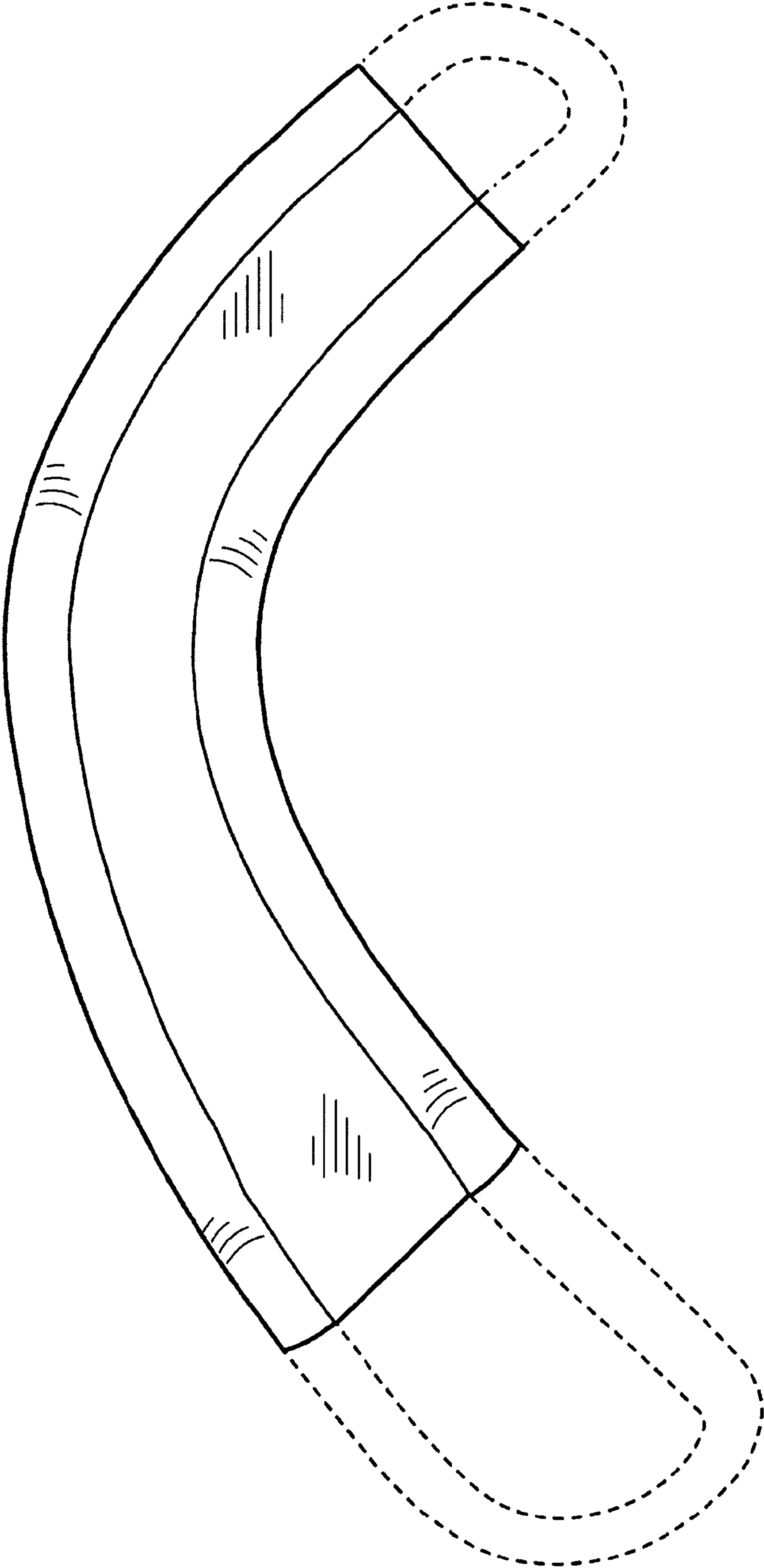

FIG. 4

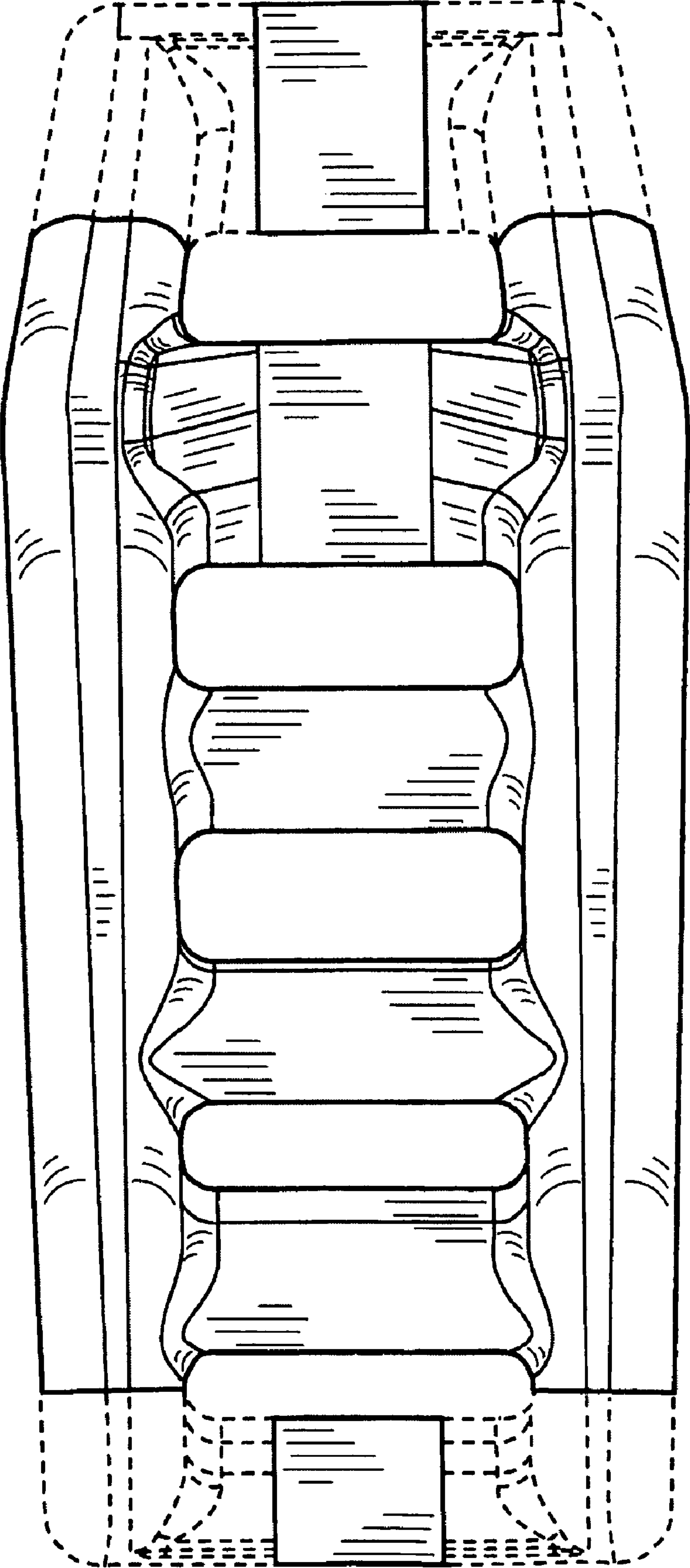

FIG. 5

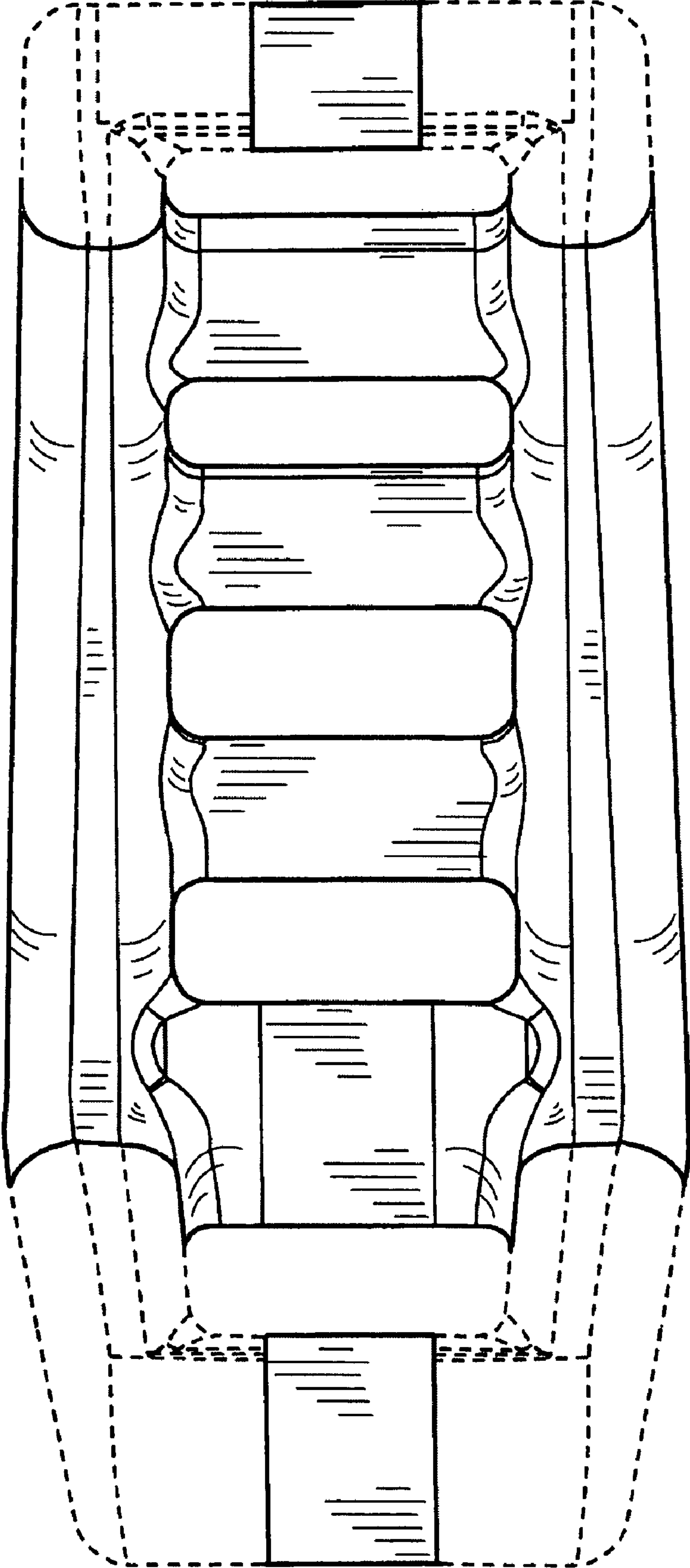

FIG. 6



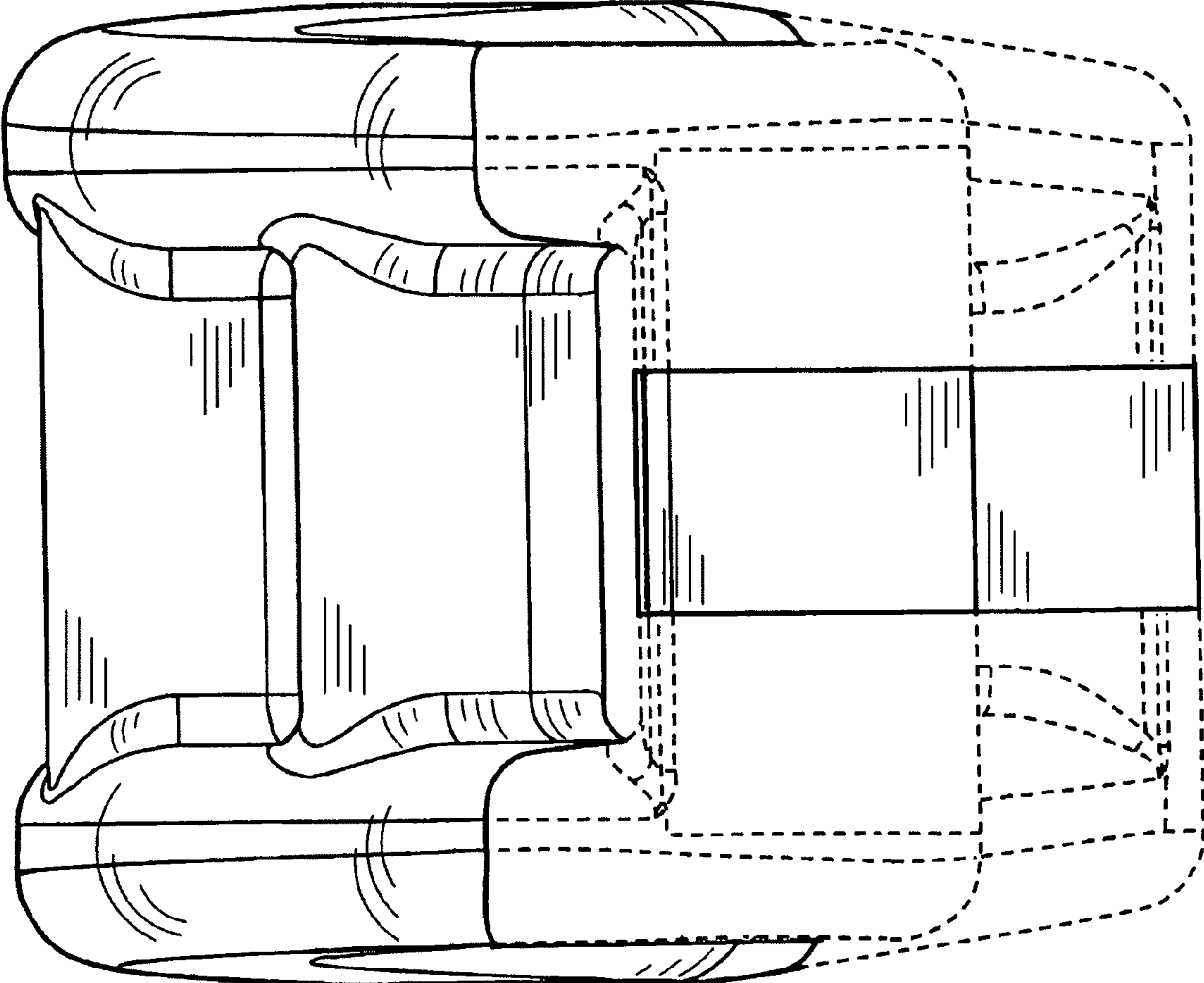

FIG. 7

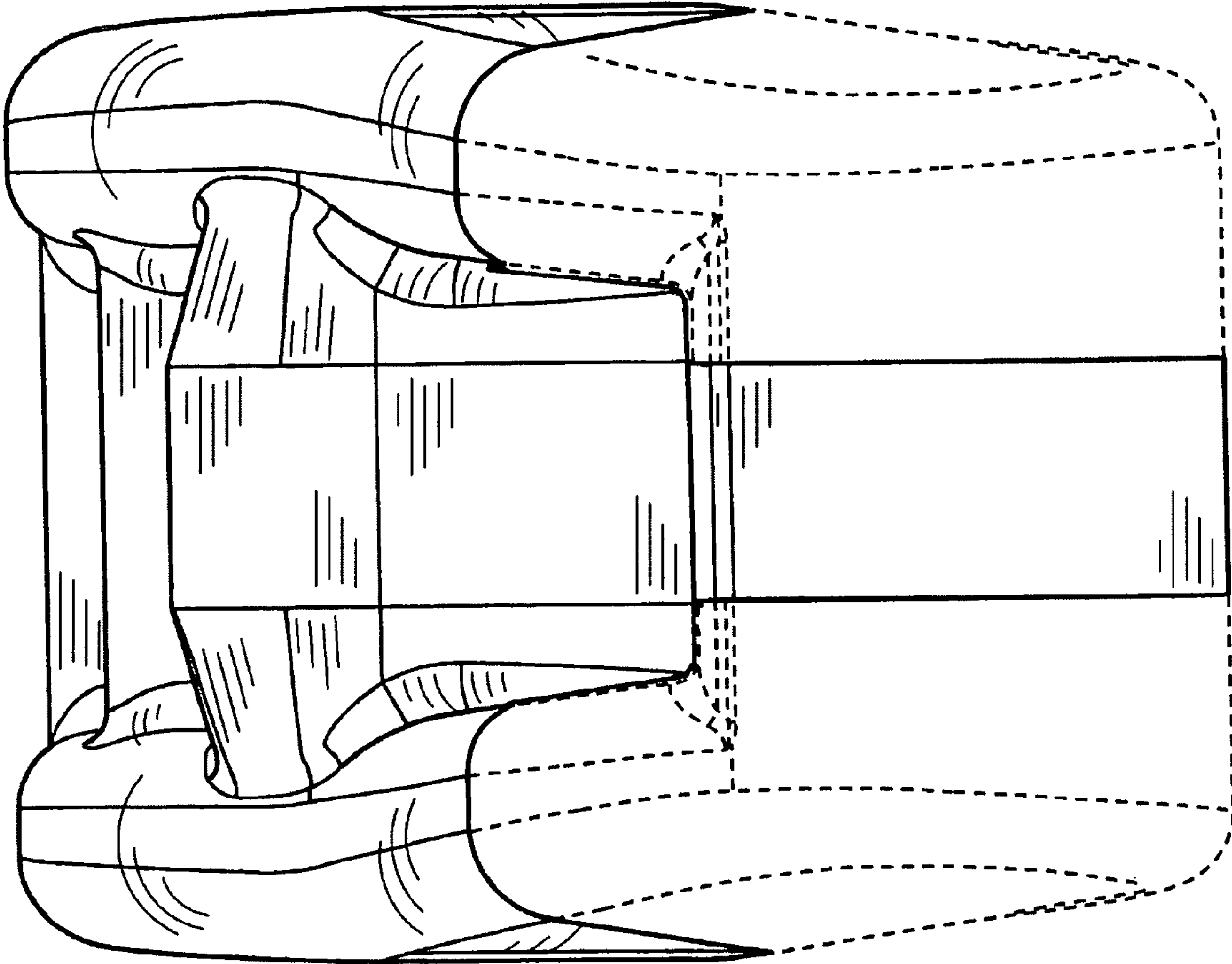

FIG. 8