



US00D612907S

(12) **United States Design Patent**
Wu et al.

(10) **Patent No.:** **US D612,907 S**
(45) **Date of Patent:** **** Mar. 30, 2010**

(54) **SHOWER HEAD**

D581,013 S * 11/2008 Citterio D23/213

(76) Inventors: **James Wu**, No. 15, Lane 160, Fongfu Rd., Taichung (TW); **Alex Wu**, No. 15, Lane 160, Fongfu Rd., Taichung (TW)

* cited by examiner

Primary Examiner—Robin V Webster
(74) *Attorney, Agent, or Firm*—Pro-Techtor Int’l Services; Ralph Willgohs

(**) Term: **14 Years**

(21) Appl. No.: **29/338,612**

(57) **CLAIM**

(22) Filed: **Jun. 15, 2009**

The ornamental design for a shower head, as shown and described.

(51) **LOC (9) Cl.** **23-01**

(52) **U.S. Cl.** **D23/229**

(58) **Field of Classification Search** D23/213, D23/229–230; 239/460–462, 282–283; 4/615
See application file for complete search history.

DESCRIPTION

FIG. 1 is a front, left perspective view of a shower head showing my new design;

FIG. 2. is a front elevational view thereof;

FIG. 3. is a rear elevational view thereof;

FIG. 4. is a left side elevational view thereof;

FIG. 5. is a right side elevational view thereof;

FIG. 6. is a top plan view thereof; and,

FIG. 7. is a bottom plan view thereof.

(56) **References Cited**

U.S. PATENT DOCUMENTS

D426,869 S *	6/2000	Chan	D23/229
D430,646 S *	9/2000	Chan	D23/229
D432,211 S *	10/2000	Chan	D23/229
D433,100 S *	10/2000	Chan	D23/229
D533,920 S *	12/2006	Dingler et al.	D23/229

1 Claim, 7 Drawing Sheets

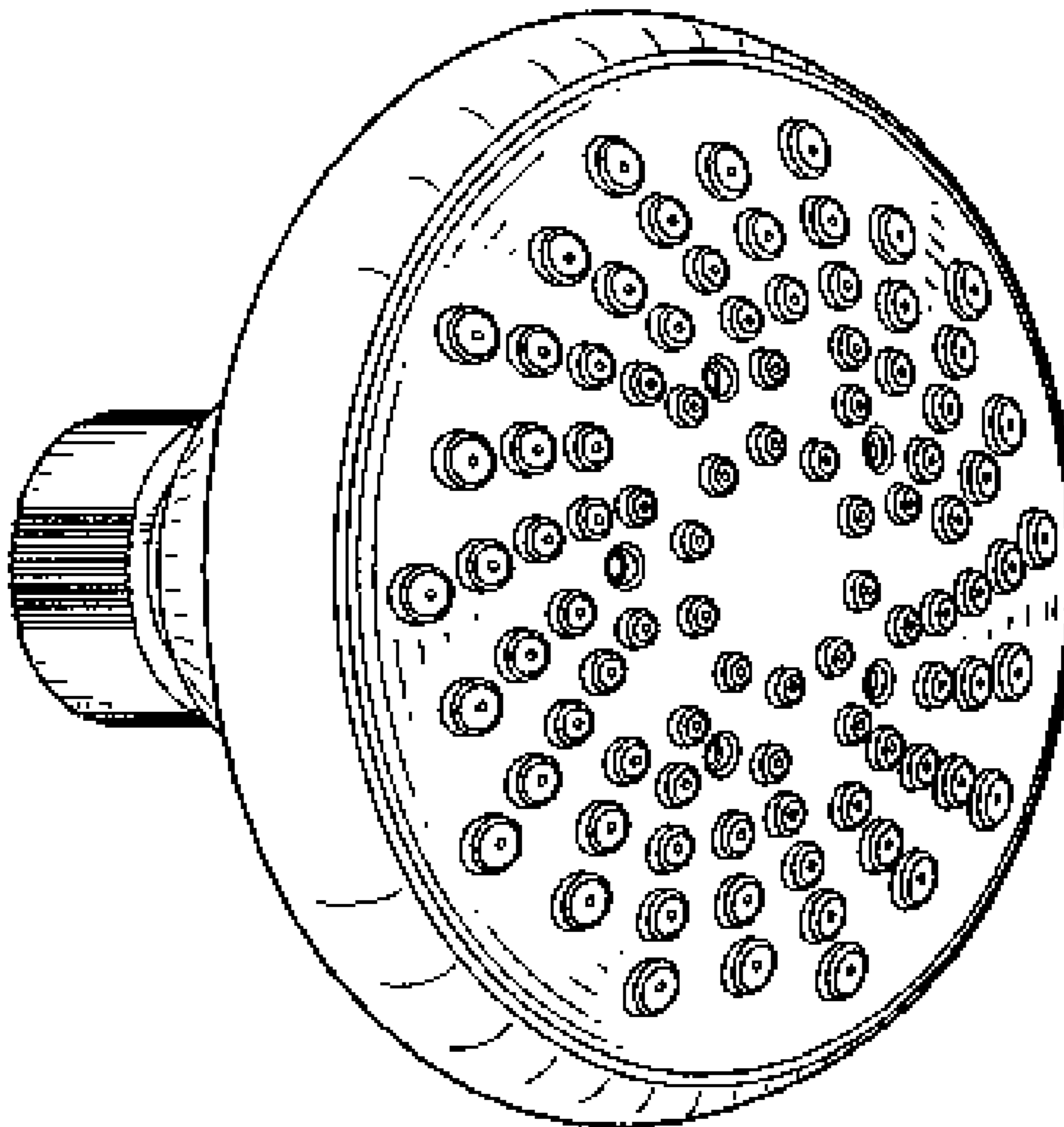

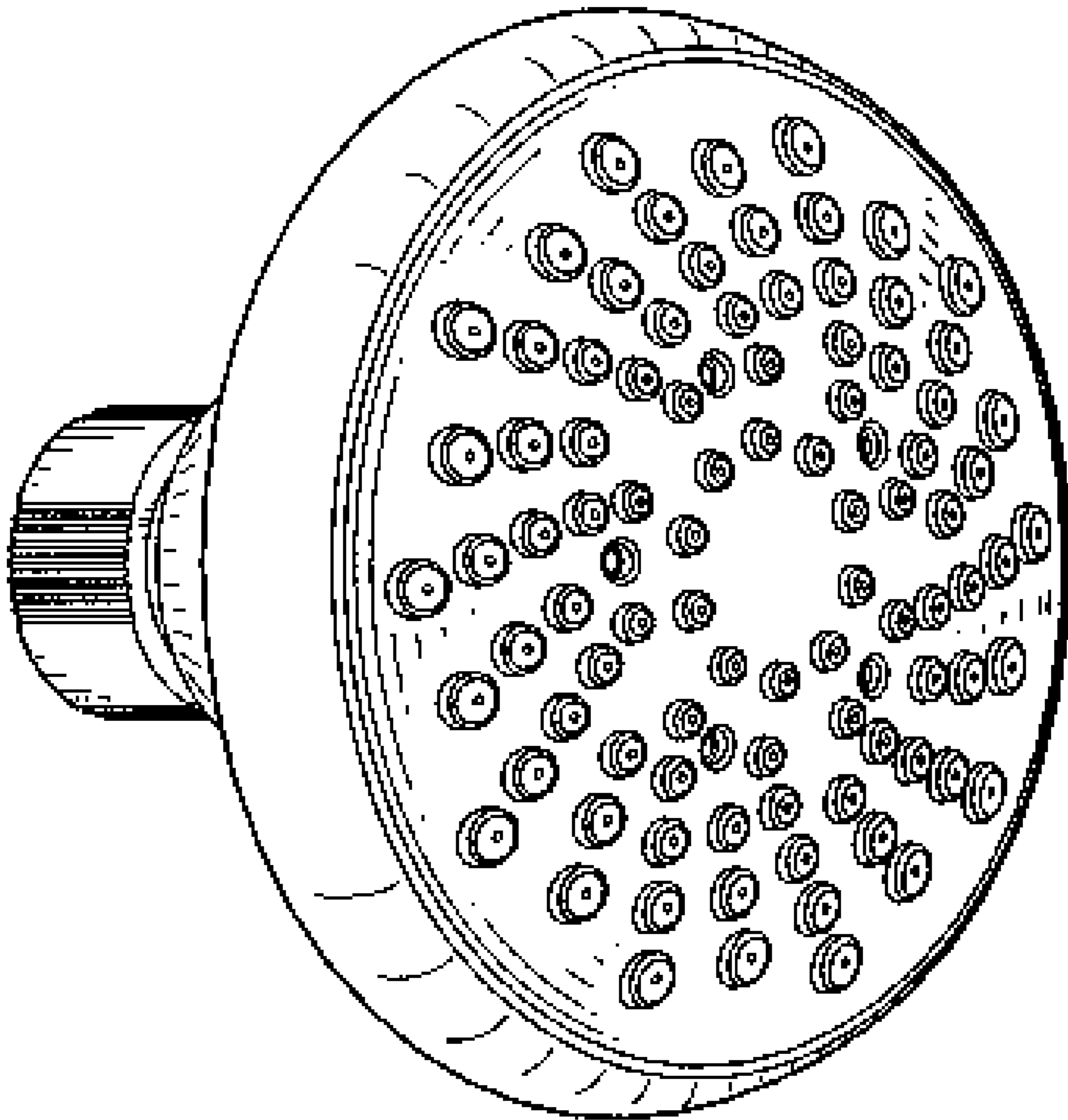

FIG. 1

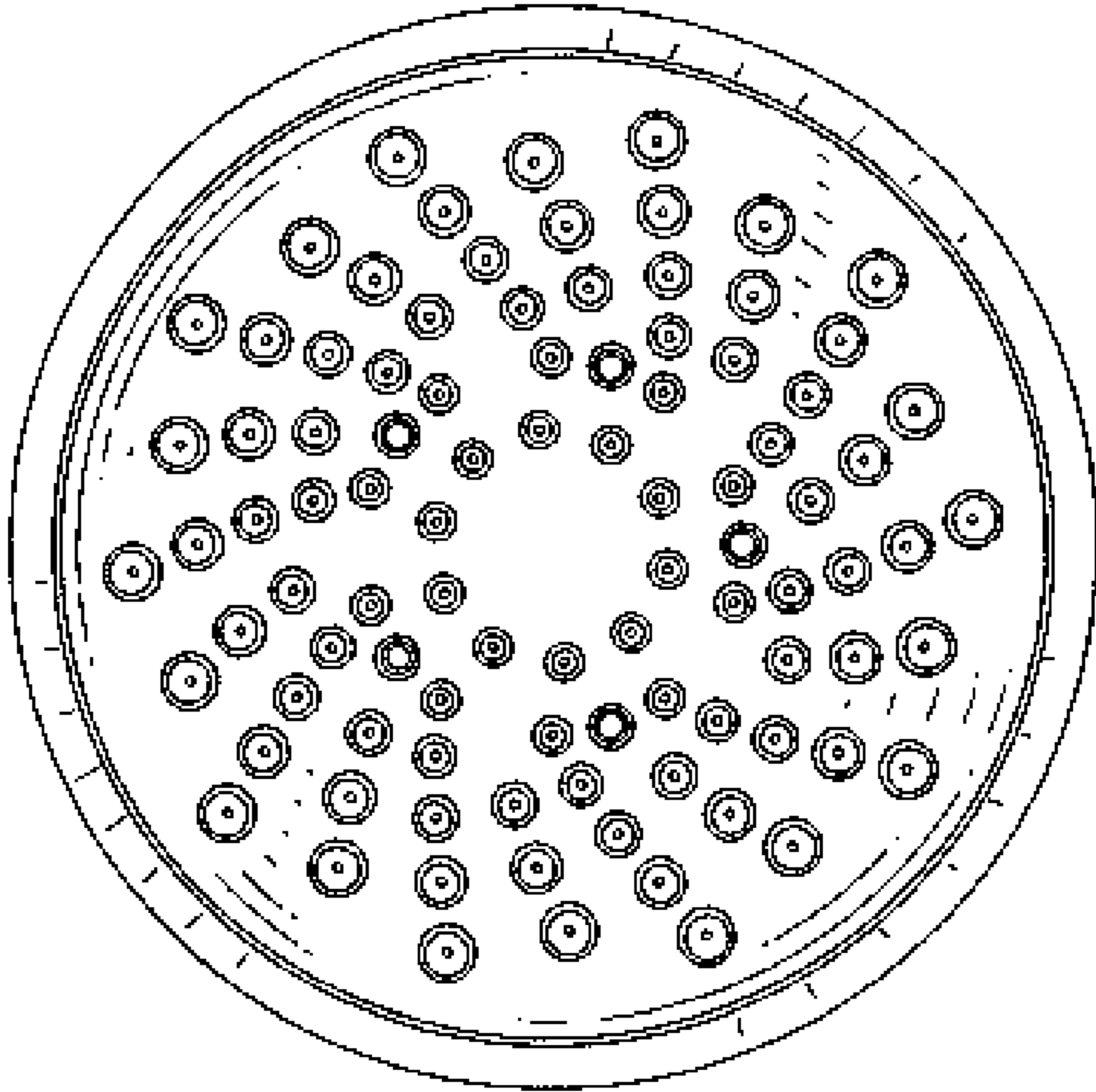

FIG. 2

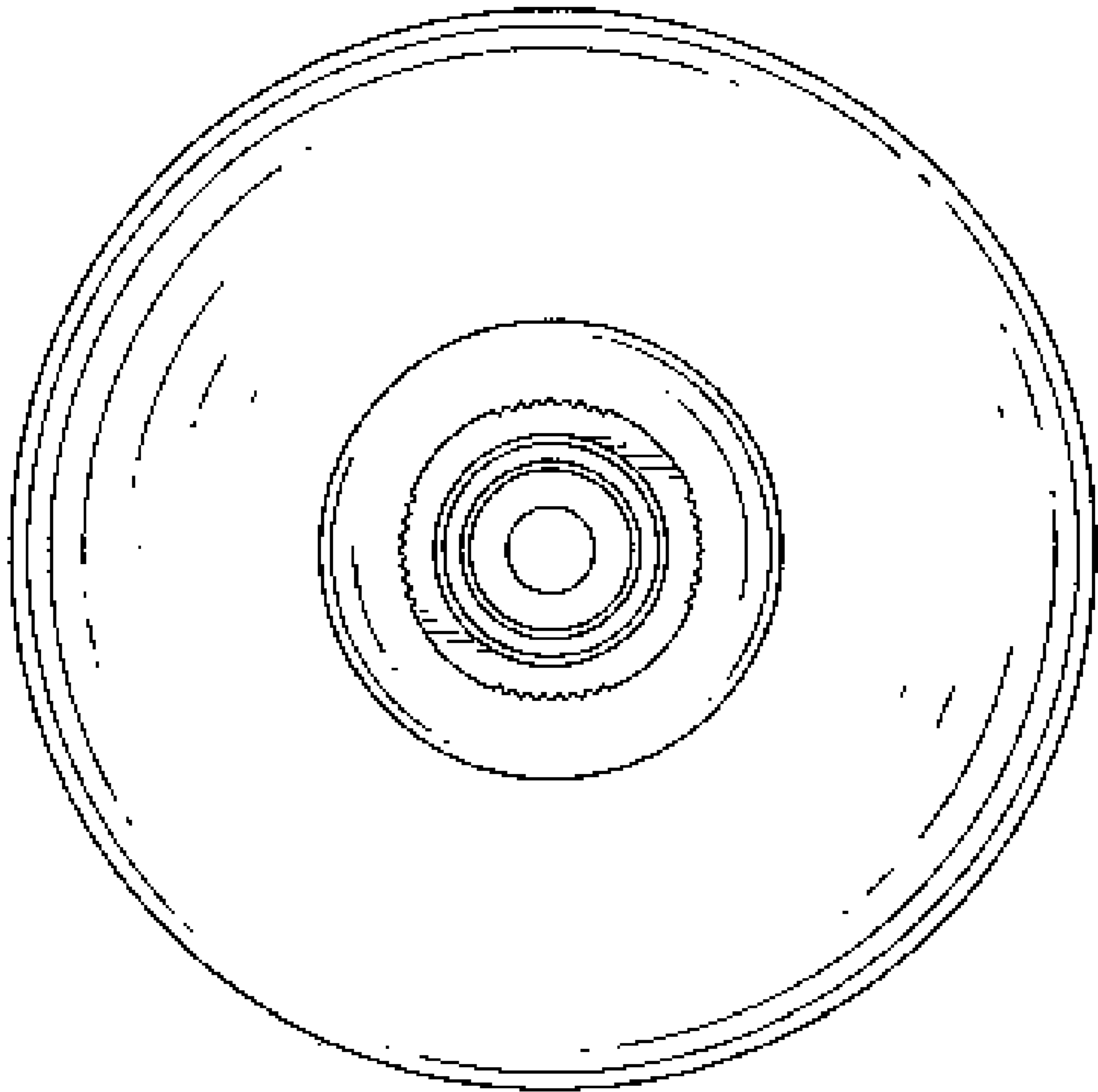

FIG. 3

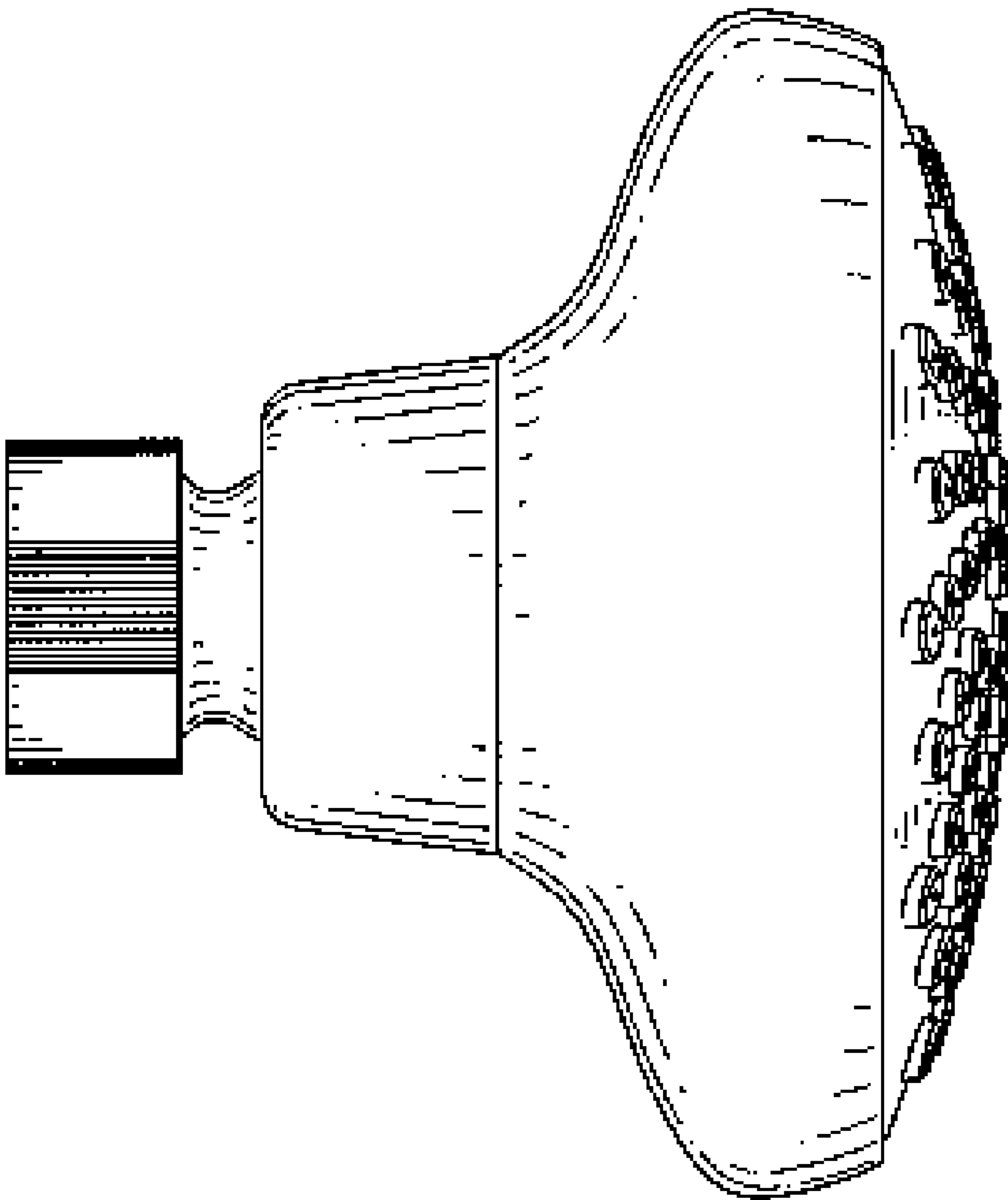

FIG. 4

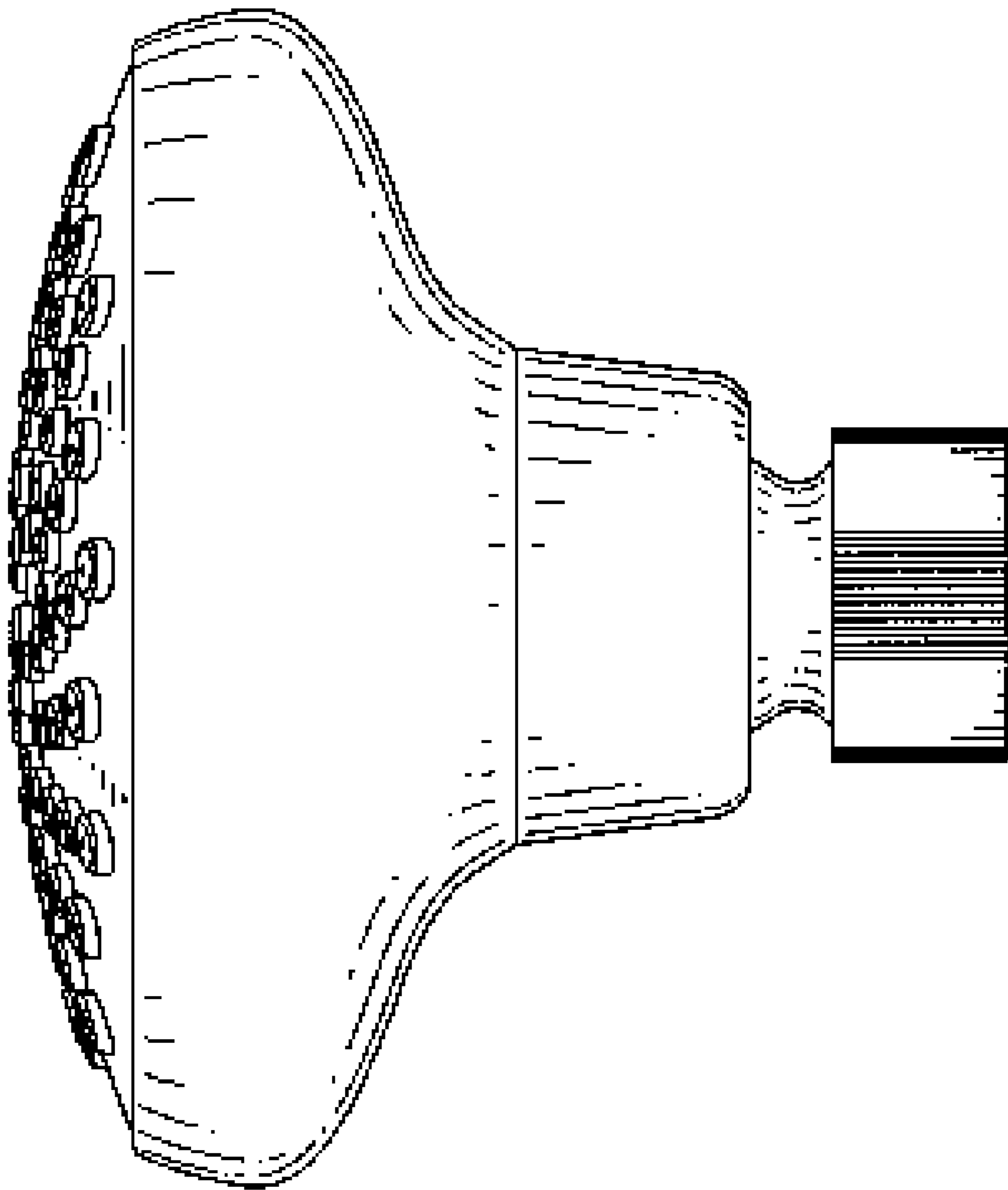

FIG. 5

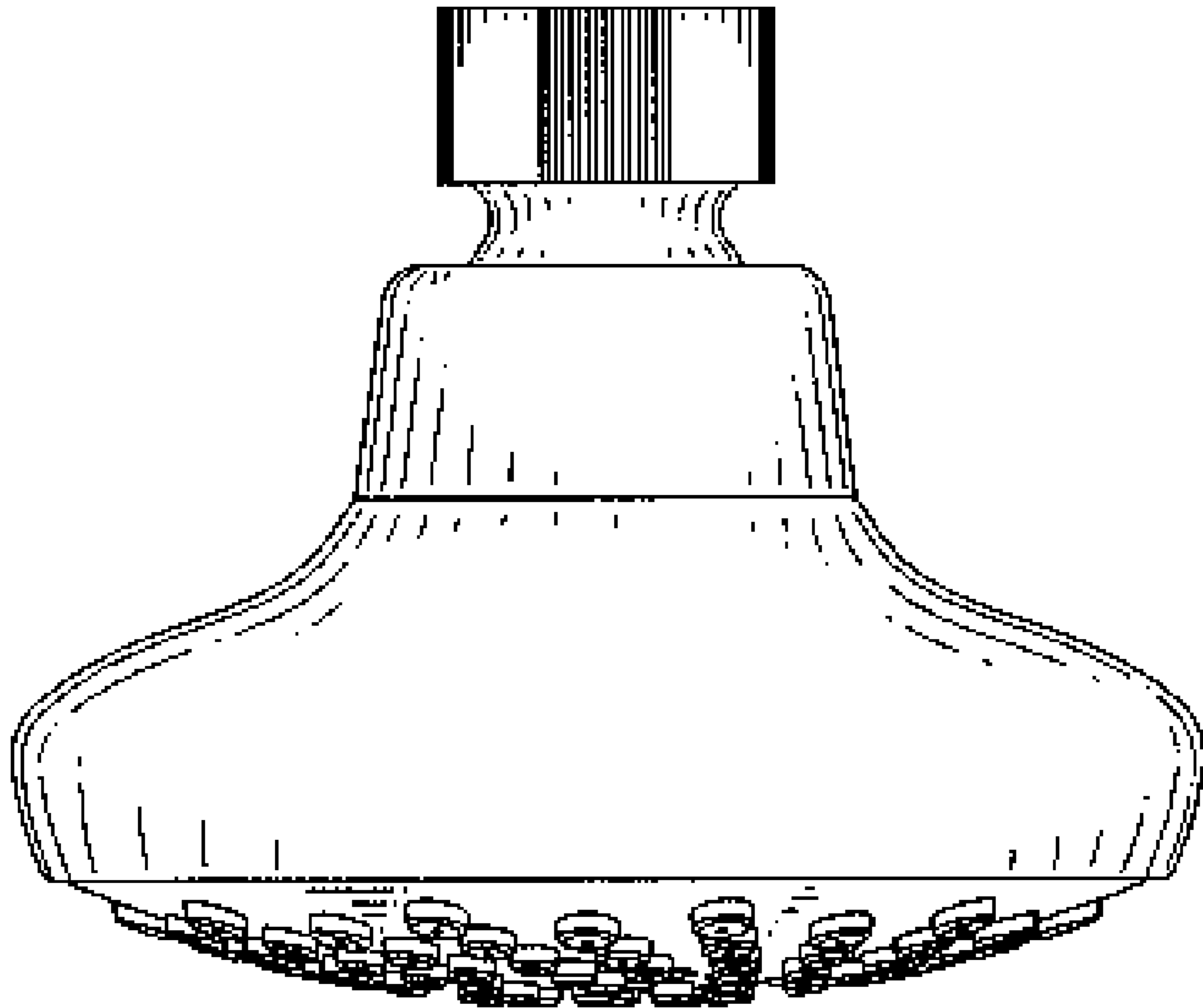

FIG. 6

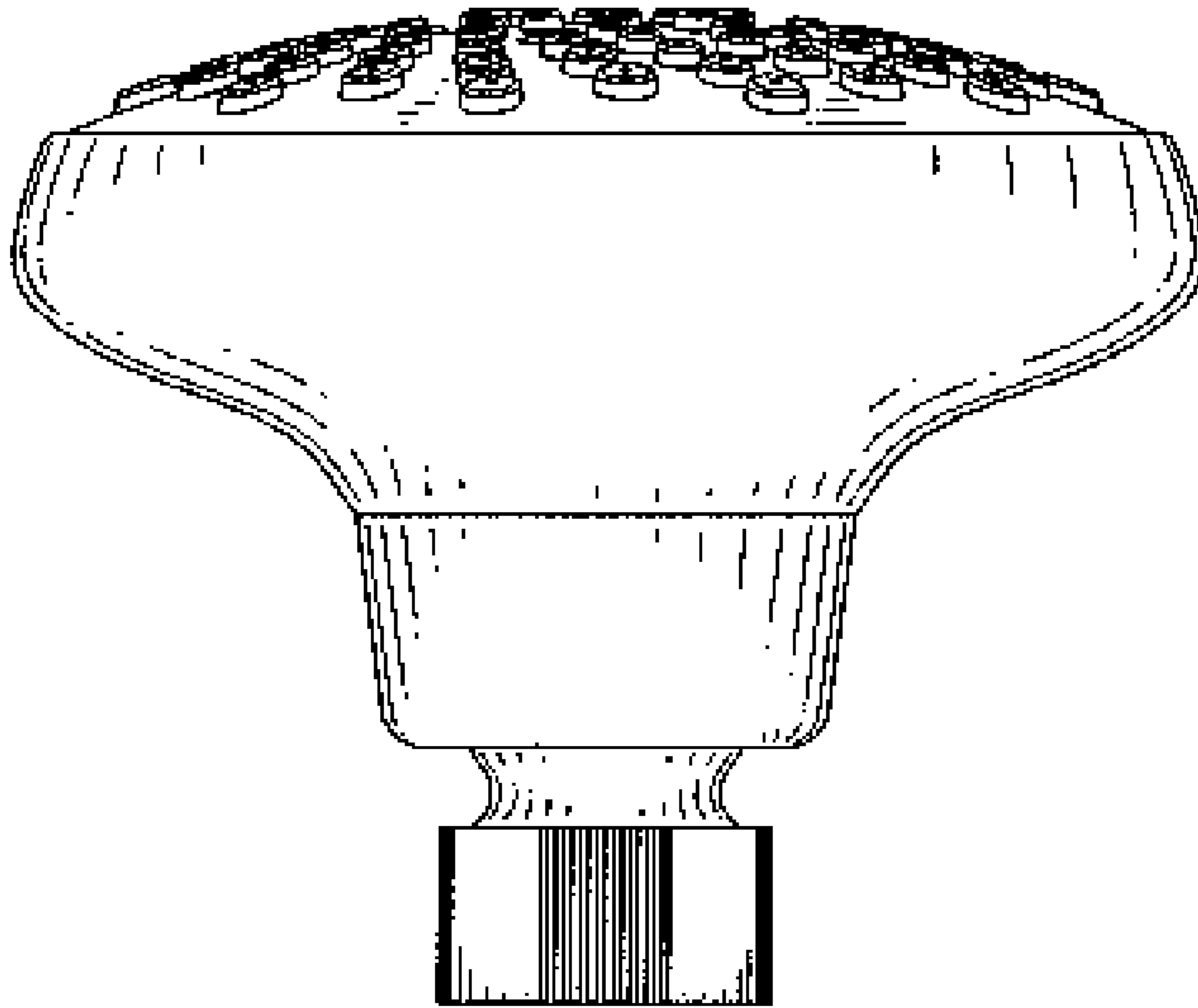

FIG. 7