



US00D612903S

(12) **United States Design Patent**
Alley et al.

(10) **Patent No.:** **US D612,903 S**
(45) **Date of Patent:** **** Mar. 30, 2010**

(54) **FOUR-ROD FISHING POLE
HOLDER/ORGANIZER**

D582,508 S 12/2008 Alley
D586,425 S 2/2009 Alley

(76) Inventors: **Corey James Alley**, P.O. Box 8747,
Madeira Beach, FL (US) 33738; **Sandra
K Alley**, P.O. Box 8747, Madeira Beach,
FL (US) 33738

* cited by examiner

Primary Examiner—Catherine R Oliver
(74) *Attorney, Agent, or Firm*—Larson & Larson, P.A.; Frank
Liebenow

(**) Term: **14 Years**

(57) **CLAIM**

(21) Appl. No.: **29/333,302**

I claim the ornamental design for an improved four-rod fish-
ing pole holder/organizer, as shown and described.

(22) Filed: **Mar. 6, 2009**

(51) **LOC (9) Cl.** **22-05**

DESCRIPTION

(52) **U.S. Cl.** **D22/147**

(58) **Field of Classification Search** D22/147,
D22/134, 149; 43/21.2, 25.2, 25; 206/315.11;
24/336, 338; 211/70.2, 70.8; D6/552, 455,
D6/457-458, 469, 446-468

FIG. 1 is a front elevation view of the improved four-rod
fishing pole holder/organizer showing my novel design;

FIG. 2 is a rear elevation view thereof;

FIG. 3 is a left side view thereof;

FIG. 4 is a right side view thereof;

FIG. 5 is a top plan view thereof;

FIG. 6 is a bottom plan view thereof; and,

FIG. 7 is a perspective view thereof.

See application file for complete search history.

The broken lines shown in FIG. 7 are for illustrative purposes
only and form no part of the claimed design.

(56) **References Cited**

U.S. PATENT DOCUMENTS

- 4,707,892 A * 11/1987 Nelson 43/25.2
- 5,072,539 A * 12/1991 Greenberg 43/21.2
- D426,282 S * 6/2000 Harmon D22/147
- D546,102 S * 7/2007 Lawrence D6/552
- D582,507 S 12/2008 Alley

1 Claim, 4 Drawing Sheets

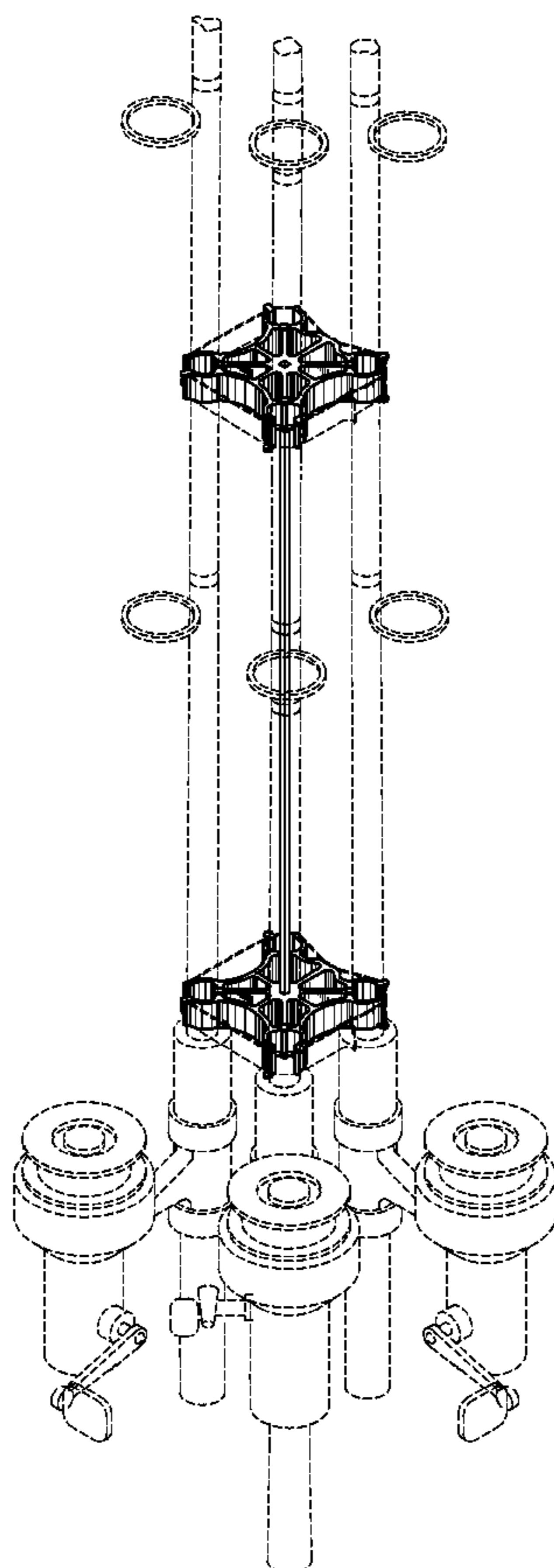

FIG. 1

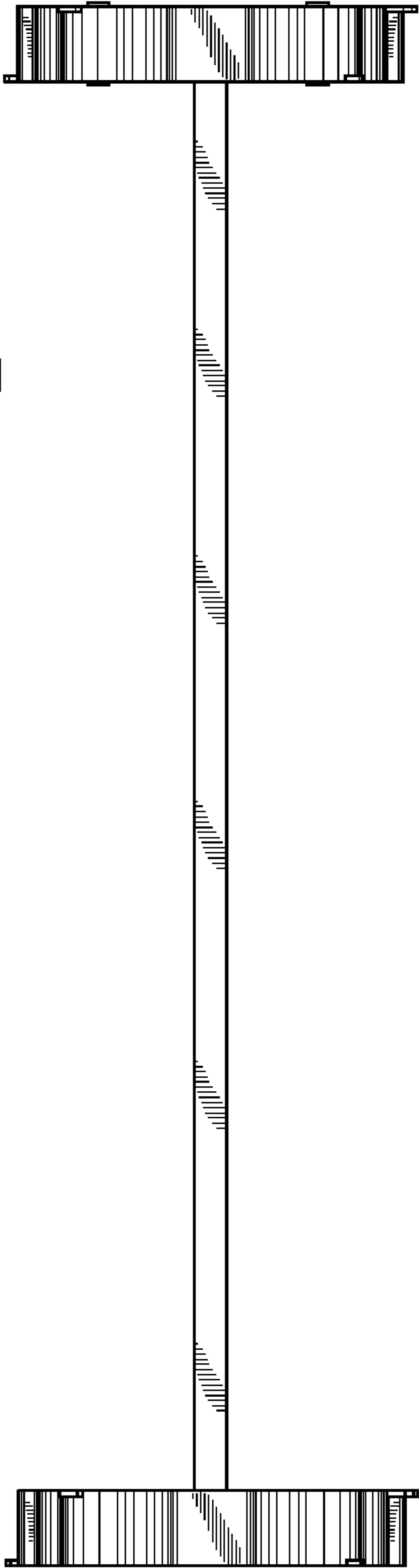

FIG. 2

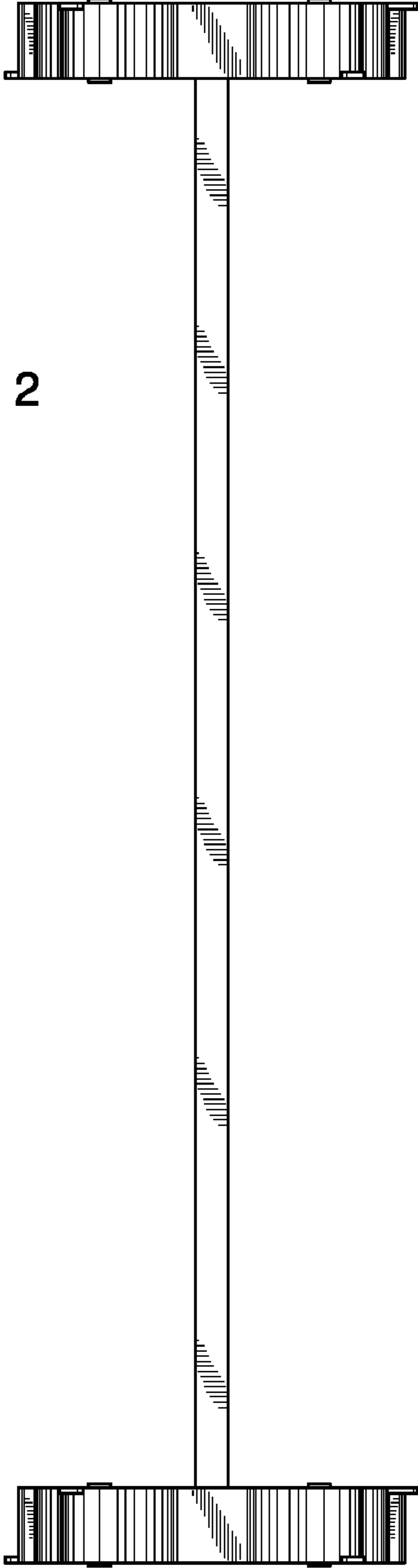

FIG. 3

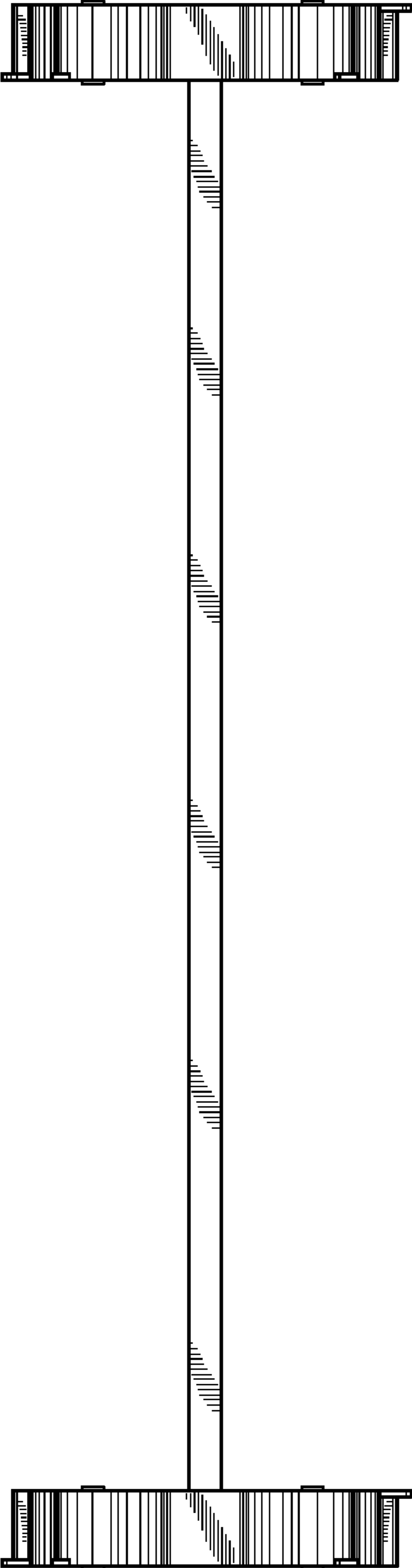

FIG. 4

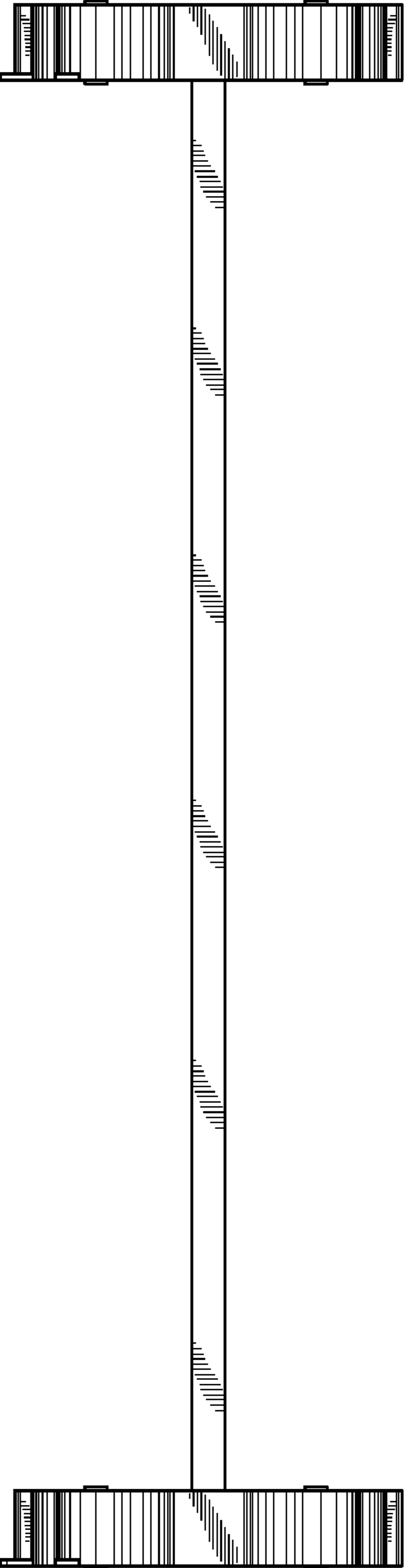

FIG. 5

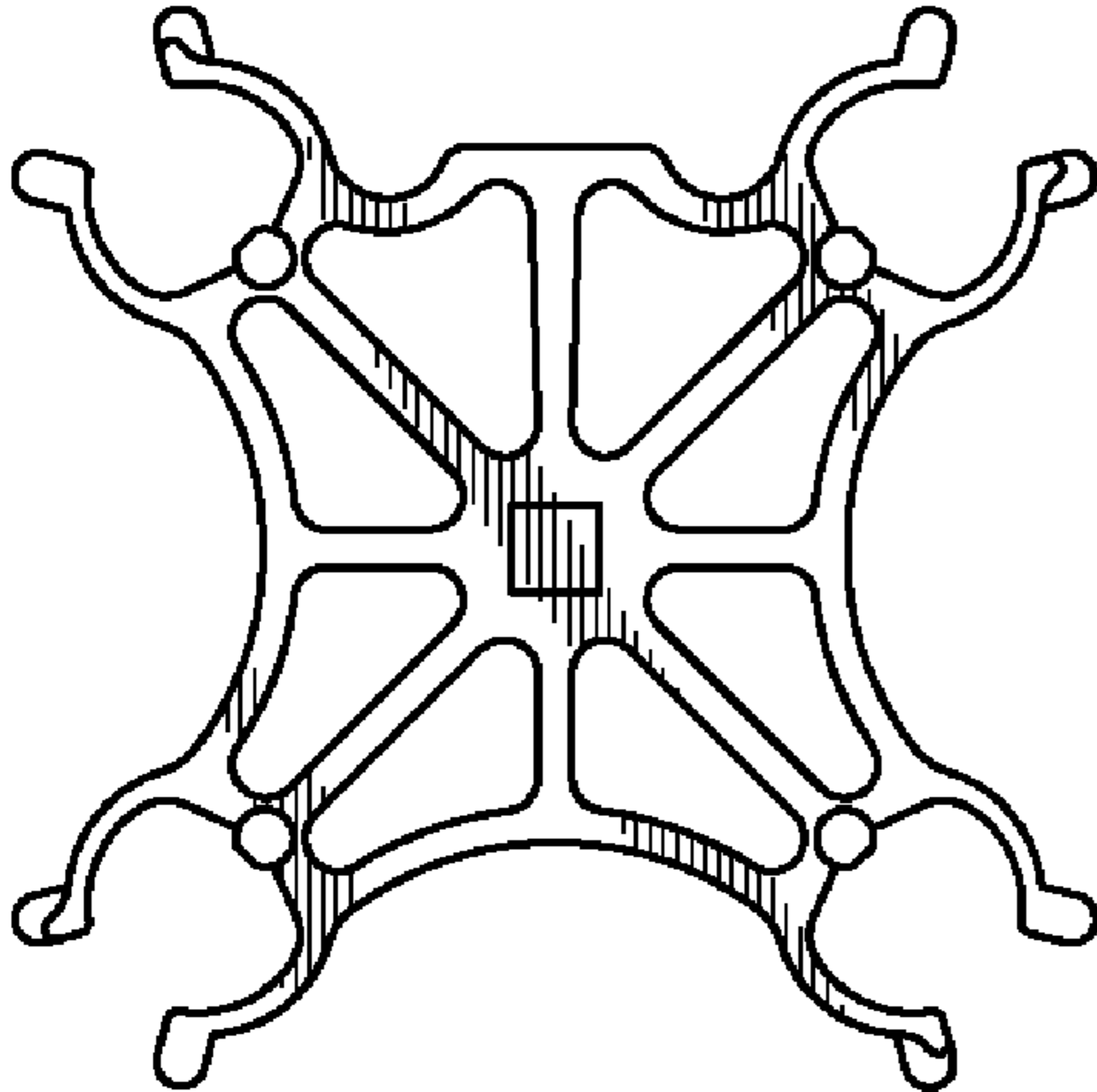

FIG. 6

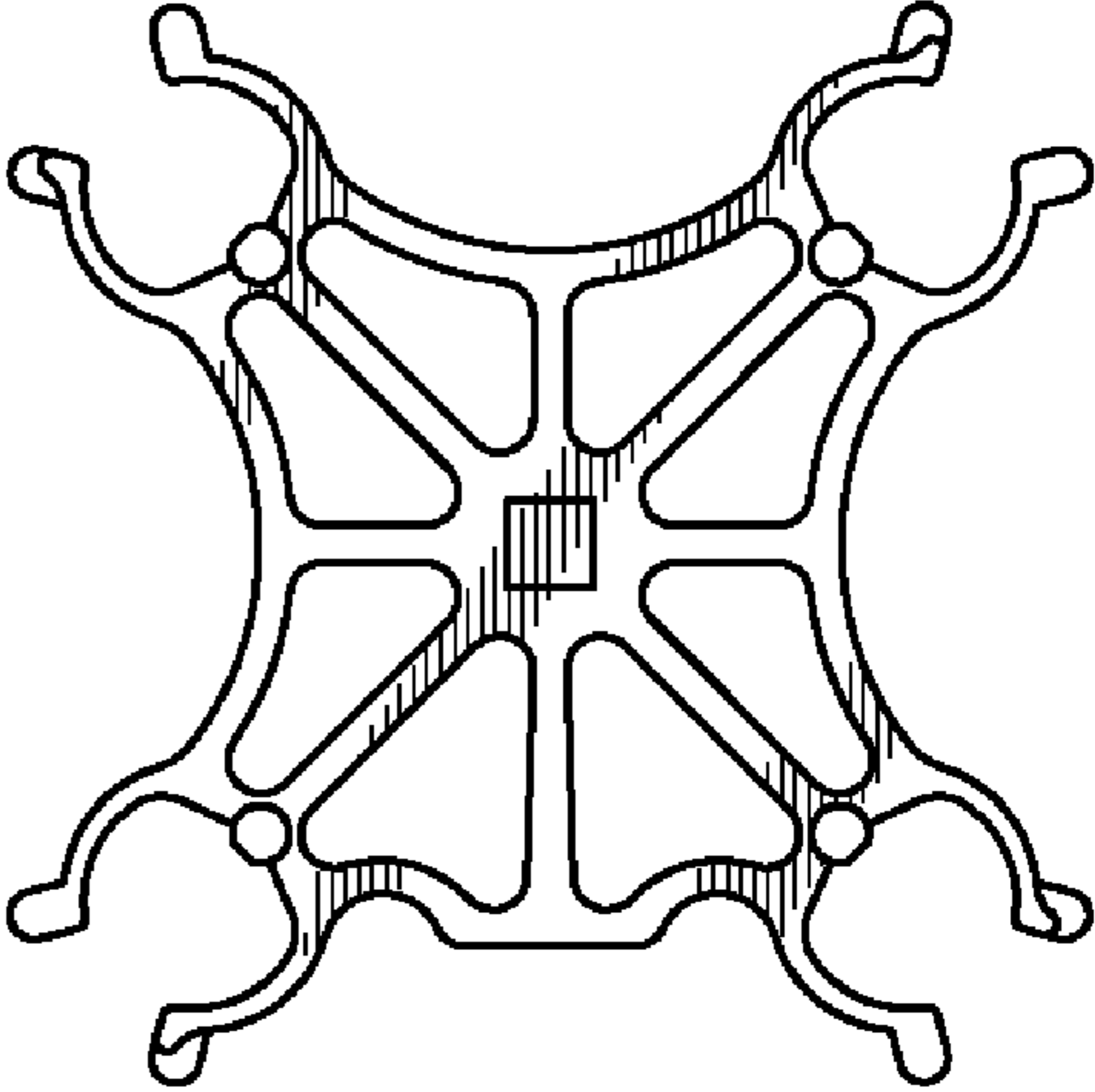

FIG. 7

