



US00D612893S

(12) **United States Design Patent**
Moyano et al.

(10) **Patent No.:** **US D612,893 S**
(45) **Date of Patent:** **** Mar. 30, 2010**

(54) **COMBINATION CARDS AND BOARD GAME**

(75) Inventors: **Matías Gutierrez Moyano**, Ciudad de Buenos Aires (AR); **Juan Descalzo**, Ciudad de Buenos Aires (AR)

(73) Assignee: **Mat Barefoot S.R.L.**, Buenos Aires (AR)

(**) Term: **14 Years**

(21) Appl. No.: **29/335,169**

(22) Filed: **Apr. 9, 2009**

(30) **Foreign Application Priority Data**

Oct. 9, 2008 (AR) 78557
Oct. 9, 2008 (AR) 78558

(51) **LOC (9) Cl.** **21-01**

(52) **U.S. Cl.** **D21/382; D21/384; D21/366**

(58) **Field of Classification Search** D21/334–369, D21/376–384; 273/236–308; 434/128–129
See application file for complete search history.

(56) **References Cited**

U.S. PATENT DOCUMENTS

D220,575 S * 4/1971 Poitras et al. D21/382
D252,343 S * 7/1979 Ilich D21/361

D273,402 S * 4/1984 Adkins D21/361
D536,385 S * 2/2007 Petricic D21/382
D546,897 S * 7/2007 Bruner D21/366
2007/0057460 A1 * 3/2007 Swaab et al. 273/259
2007/0257432 A1 * 11/2007 Gardner-Anopol 273/238

* cited by examiner

Primary Examiner—Sandra Morris

(74) *Attorney, Agent, or Firm*—The Webb Law Firm

(57) **CLAIM**

The ornamental design for a combination cards and board game, as shown and described.

DESCRIPTION

FIGS. 1–70 are top views of cards for a combinations cards and board game showing our new design;

FIG. 71 is a bottom view of each of the cards of FIGS. 1–70; and,

FIG. 72 is a top view of a game board for a combinations cards and board game showing our new design.

The relative scale of FIGS. 1–72 forms no part of the claimed design.

The broken line showings of the peripheries of FIGS. 1–72 are for illustrative purposes only and form no part of the claimed design.

1 Claim, 10 Drawing Sheets

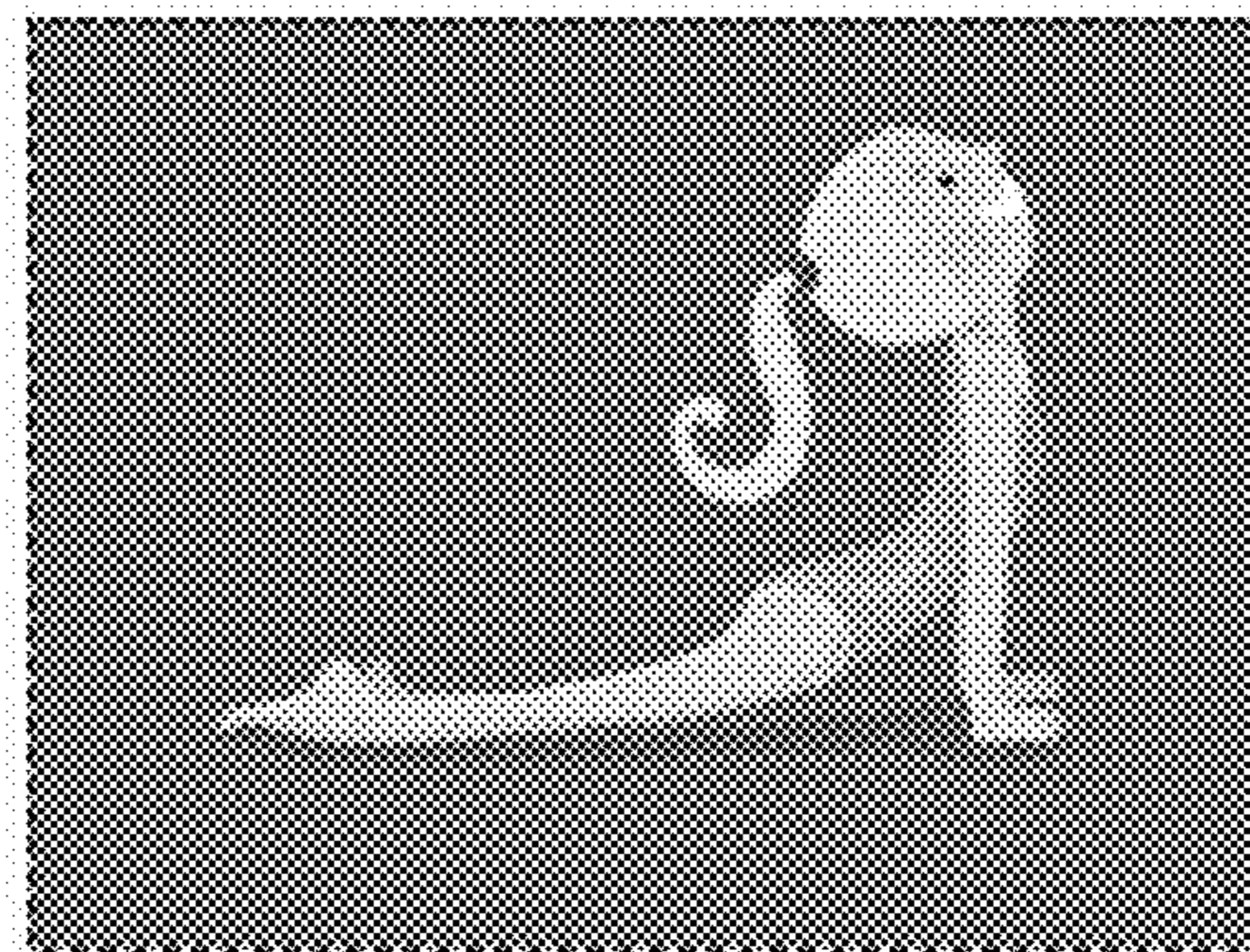
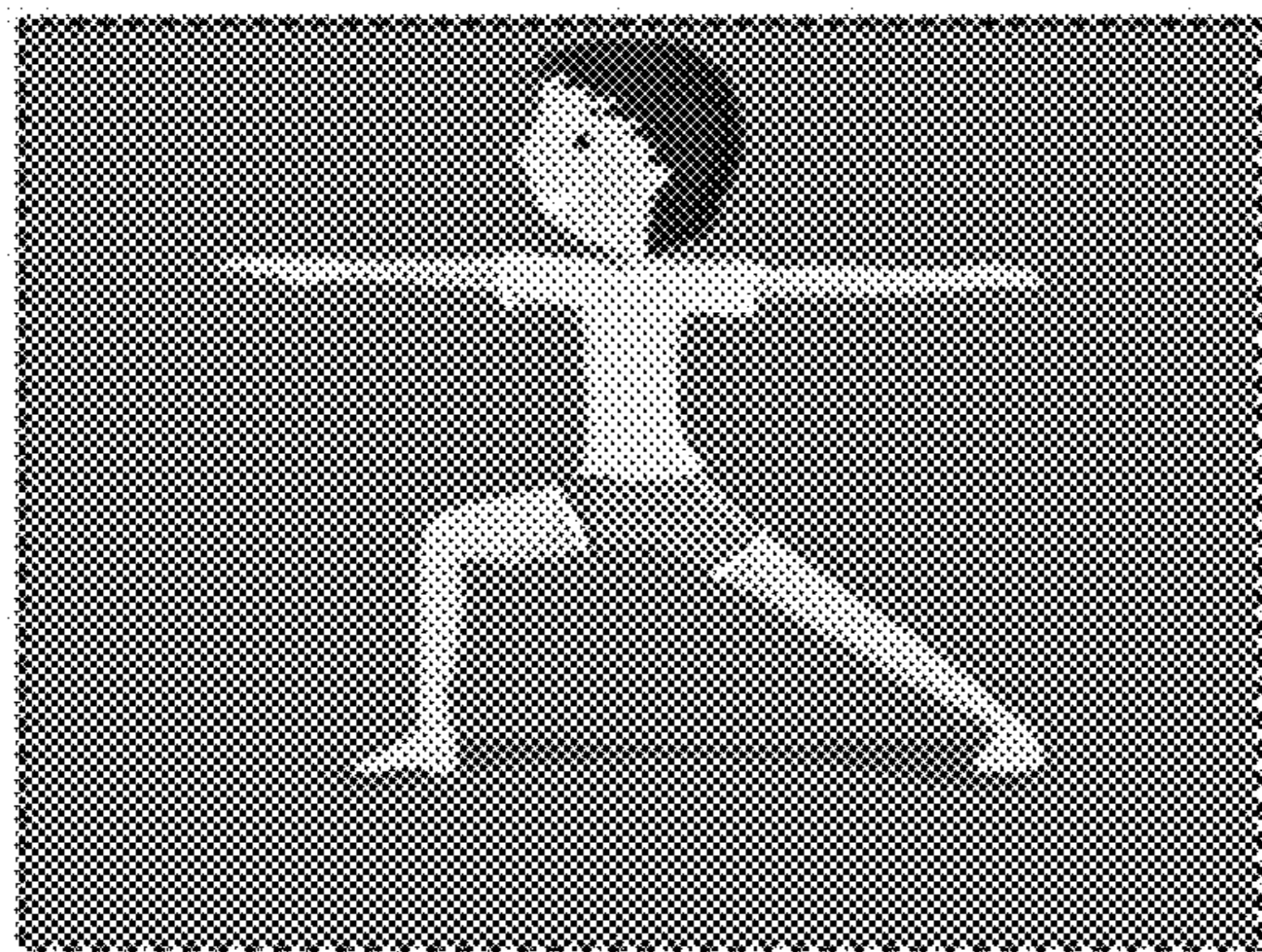

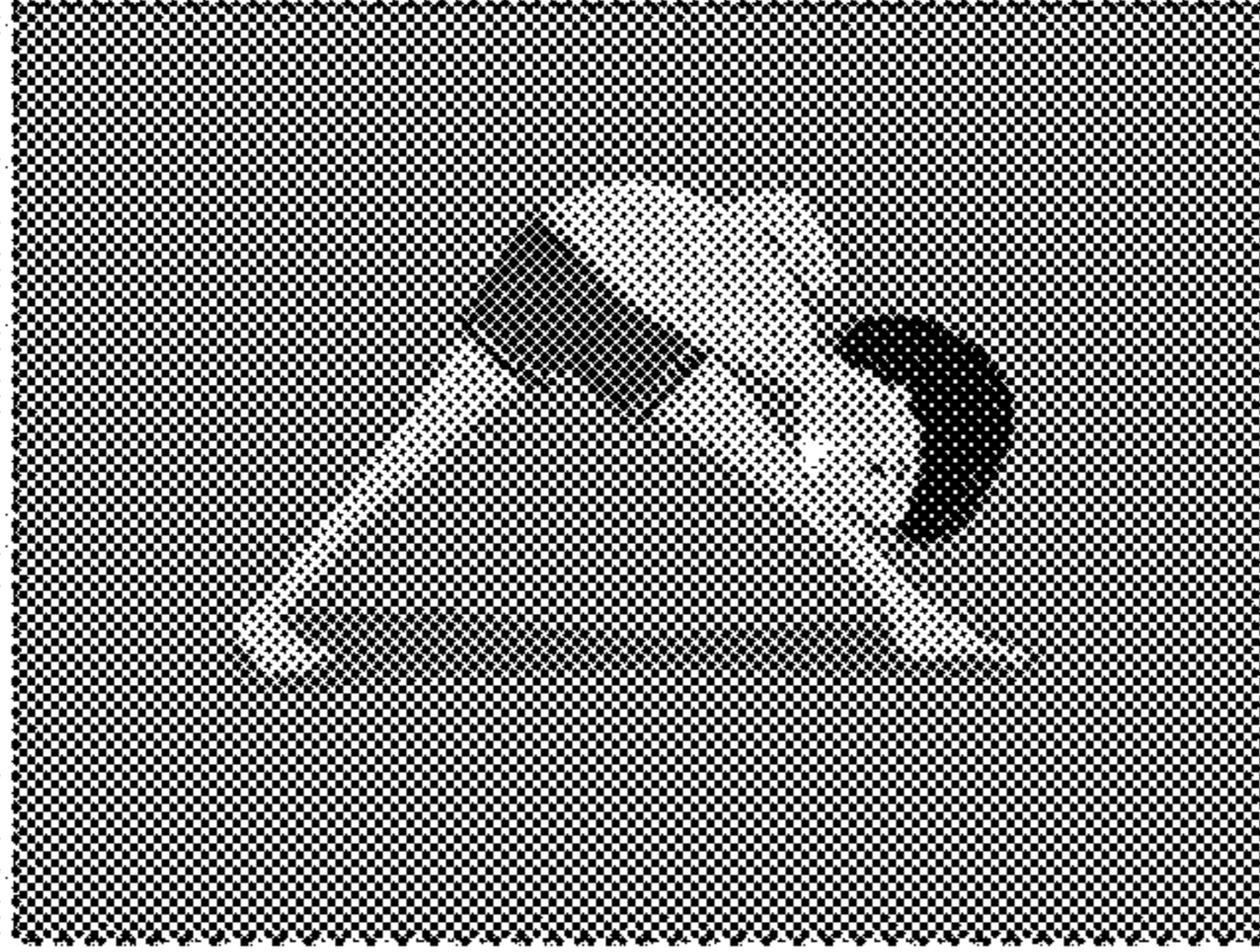

FIG. 1

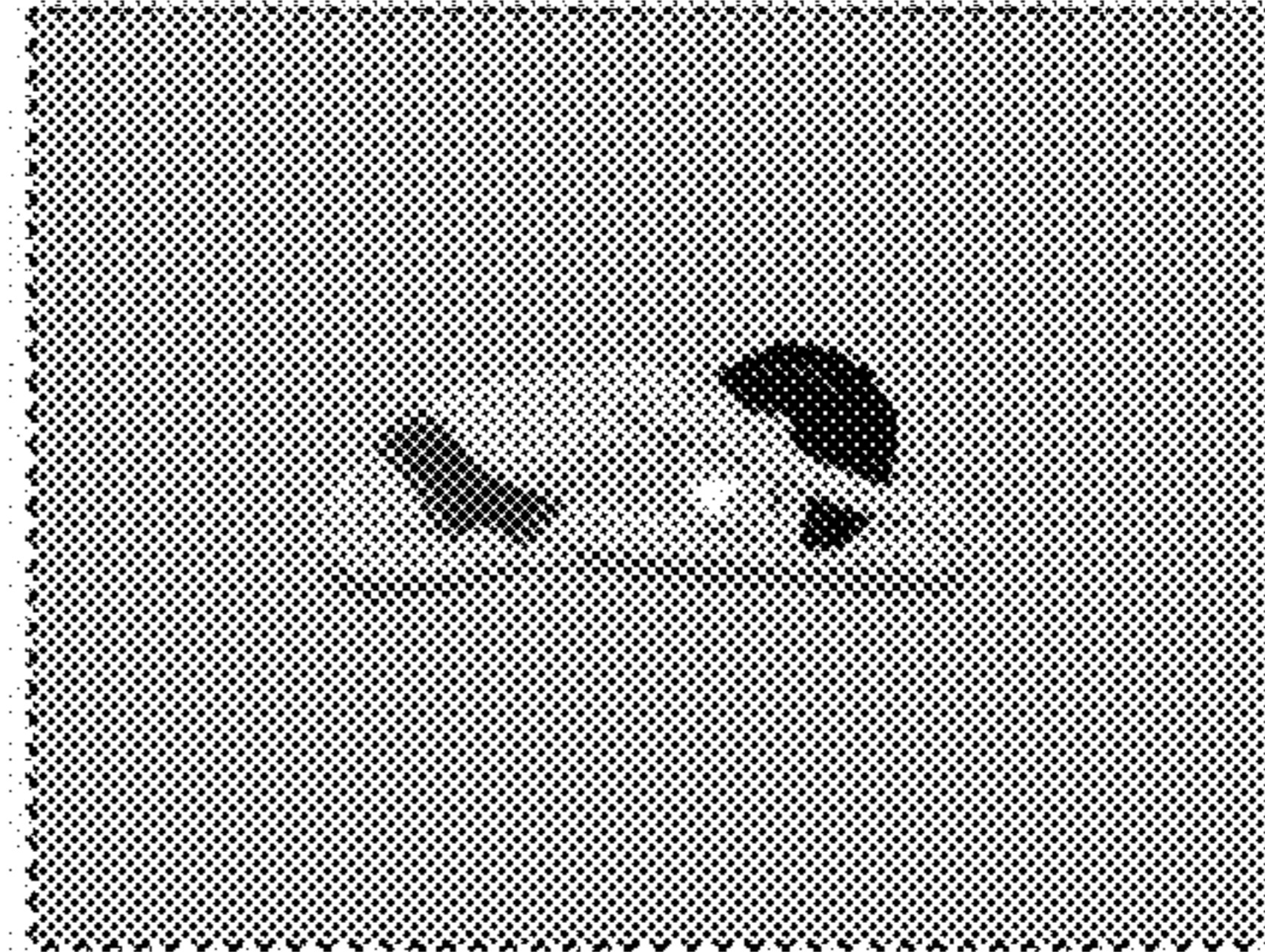

FIG. 2

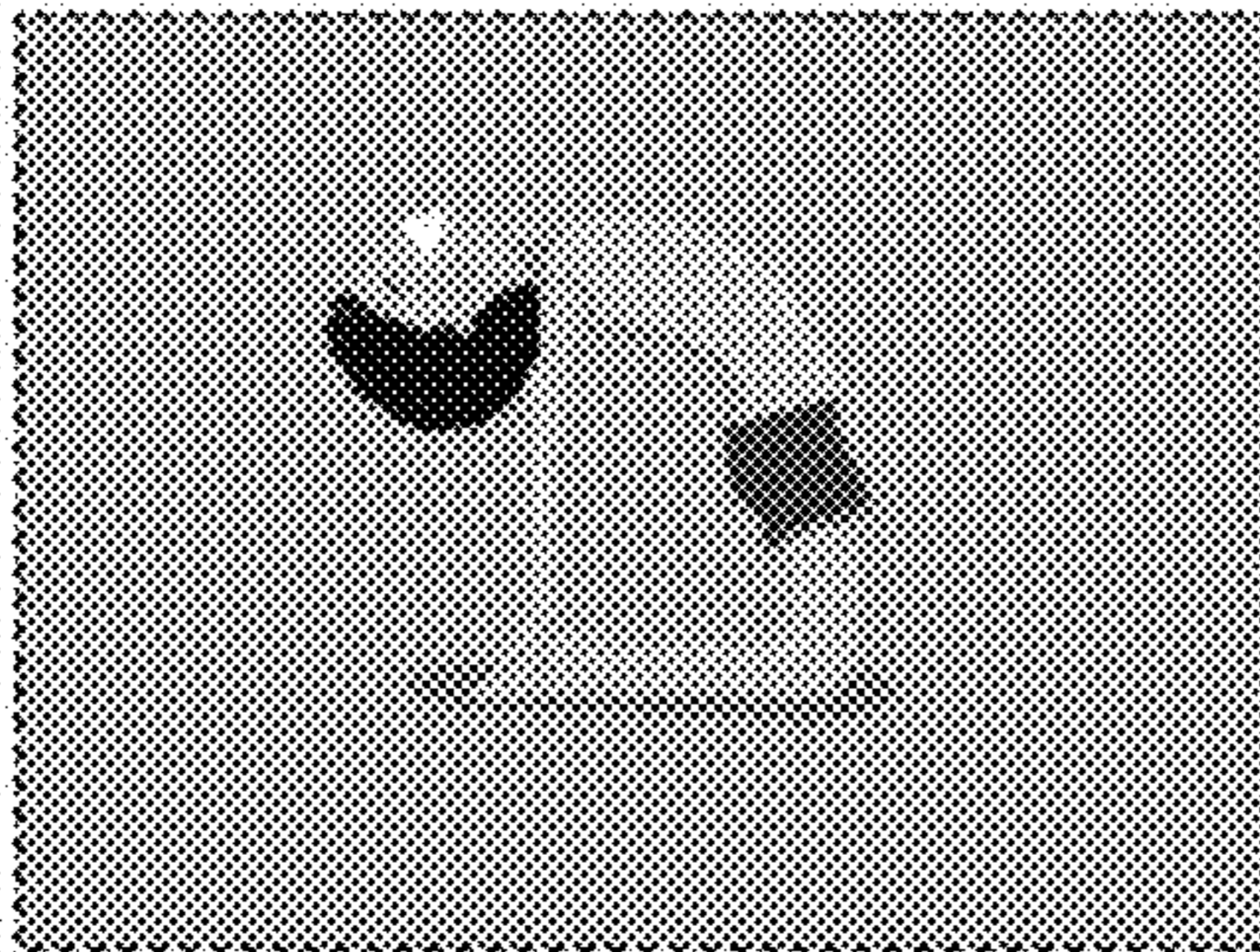

FIG. 3

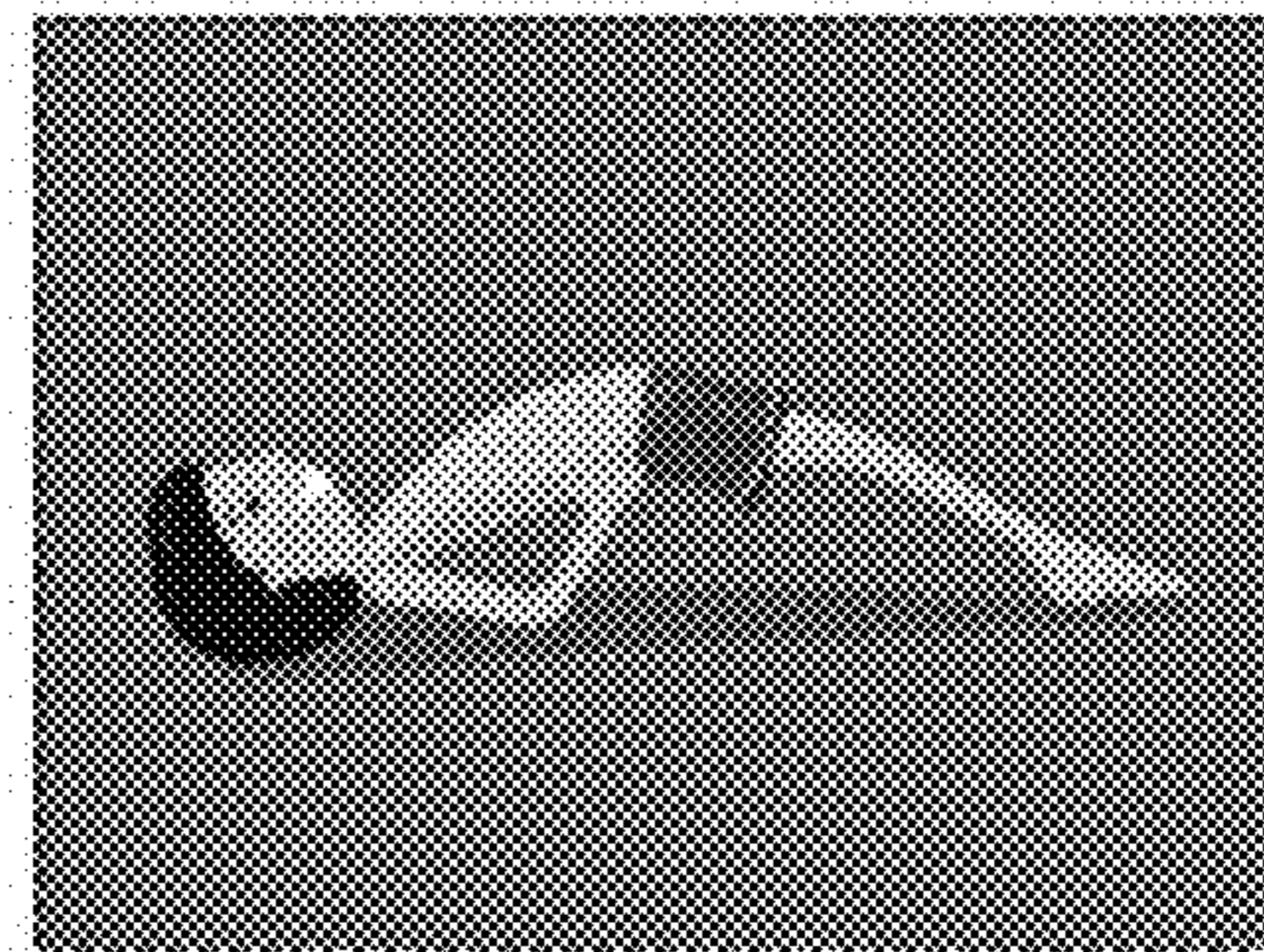

FIG. 4

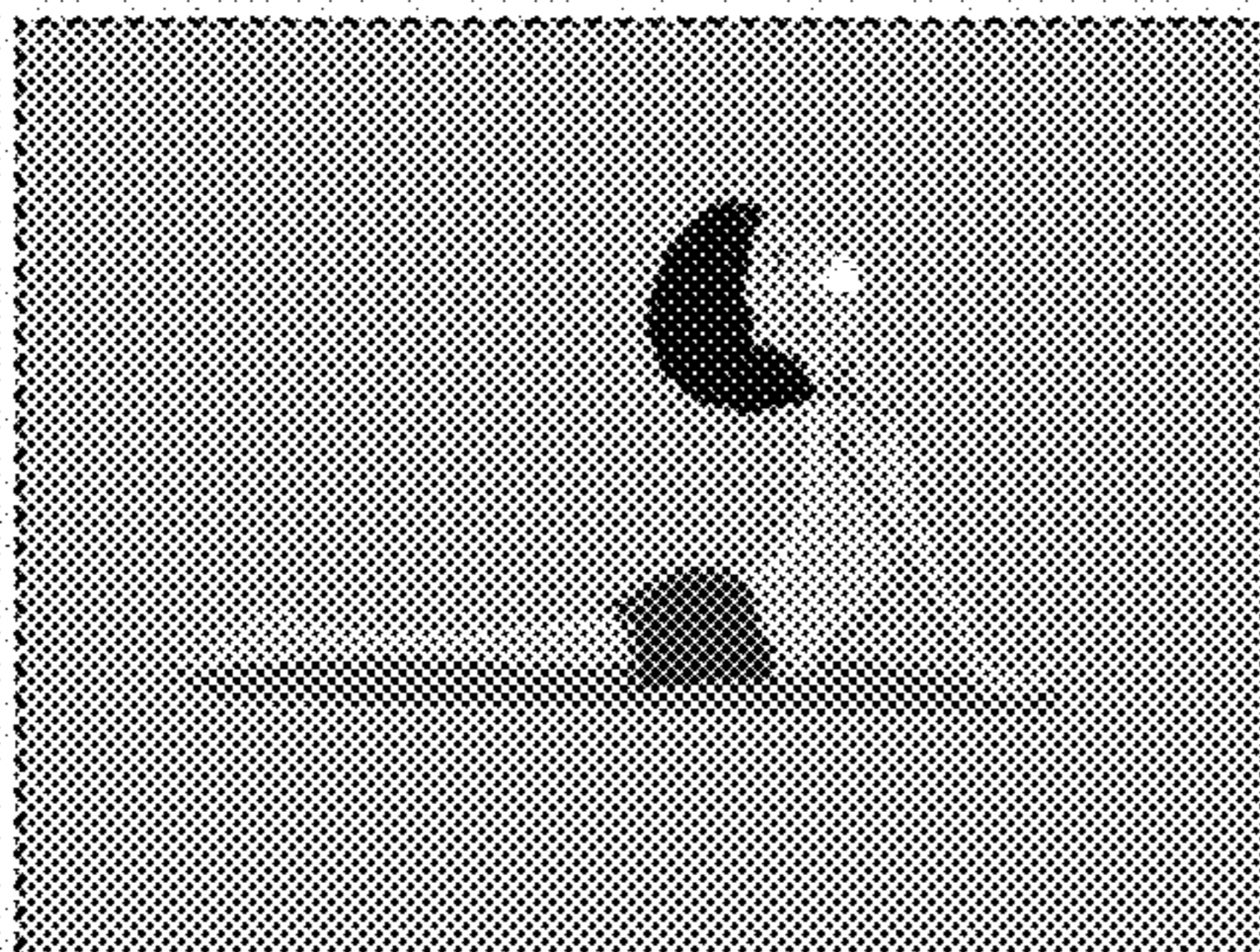

FIG. 5

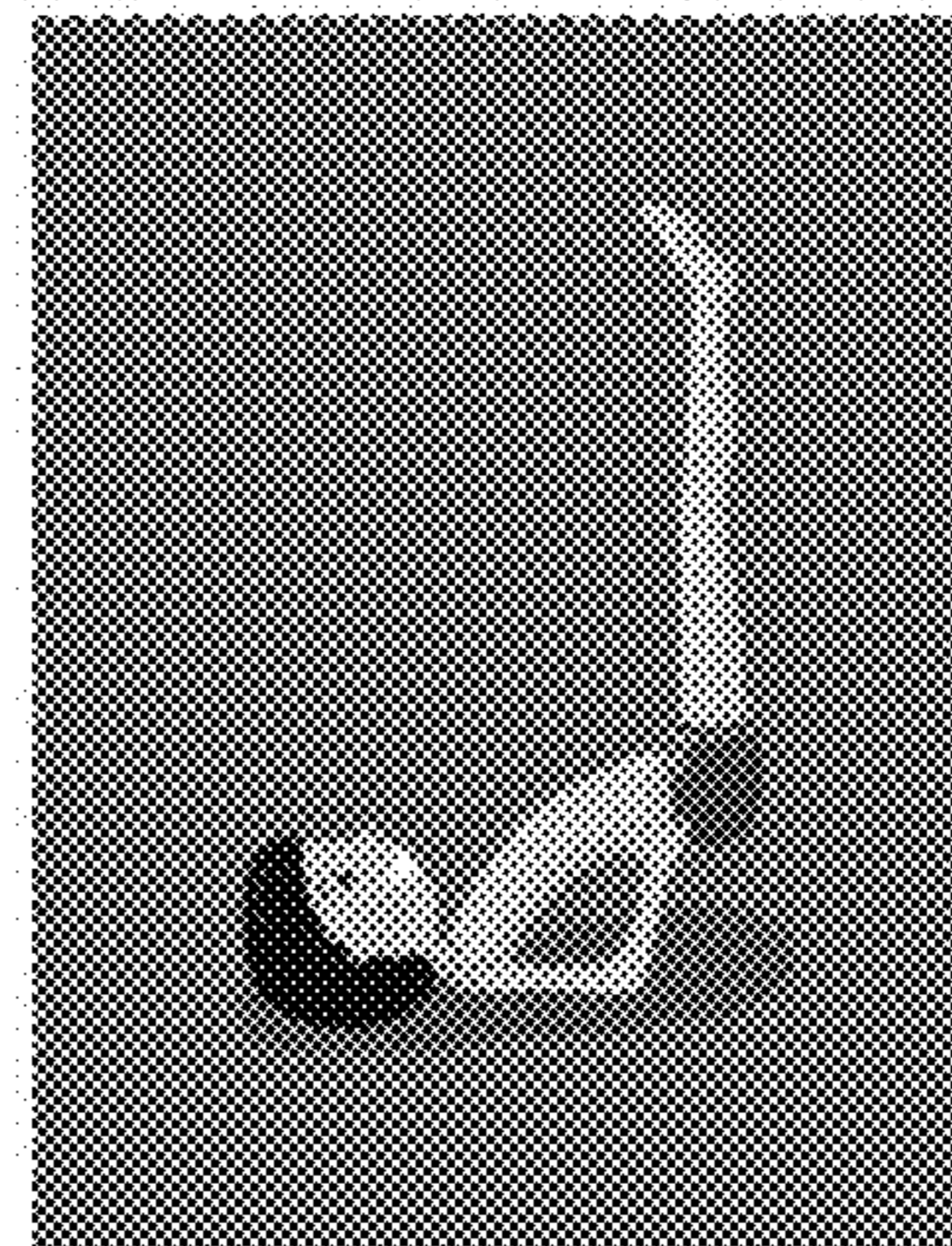

FIG. 6

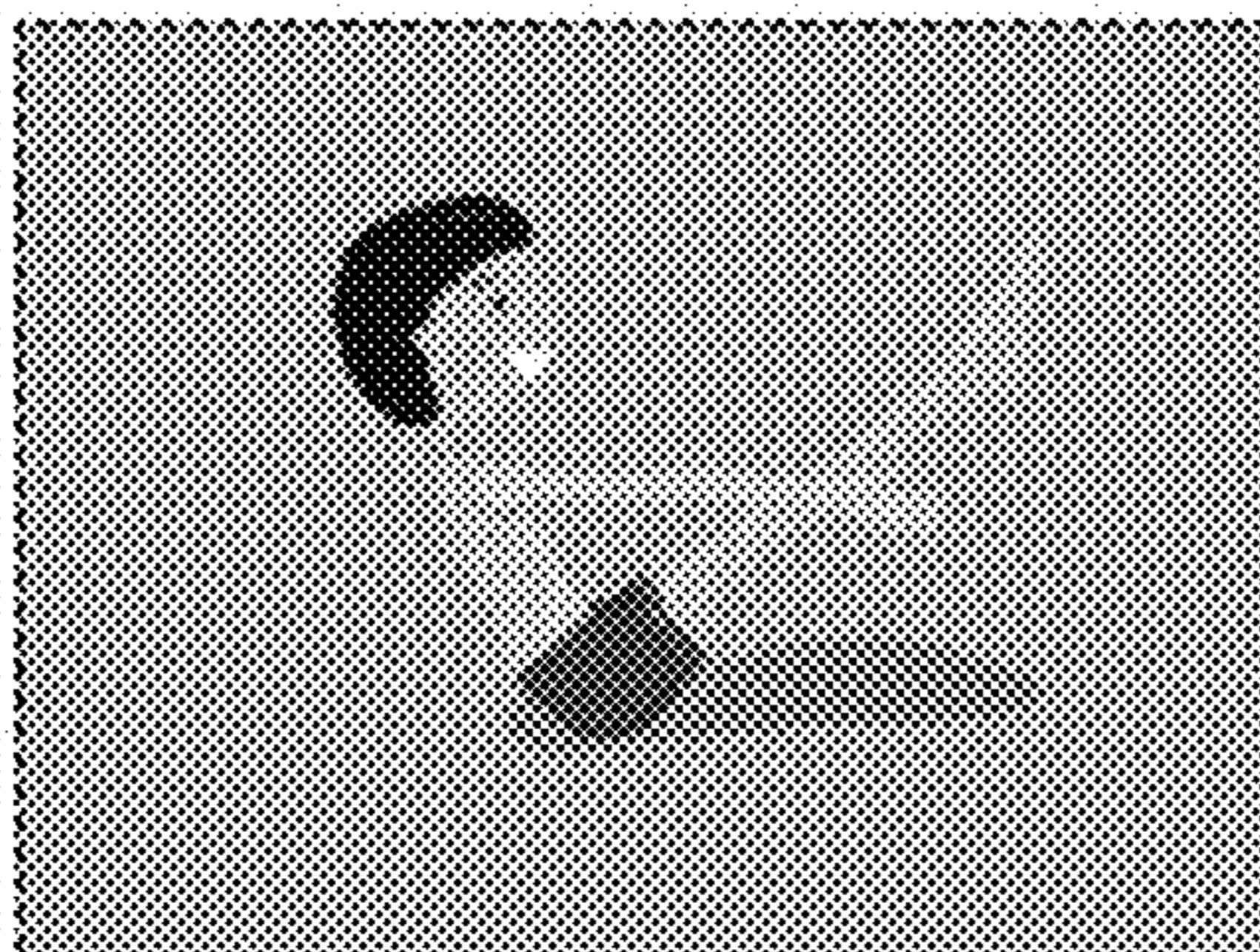

FIG. 7

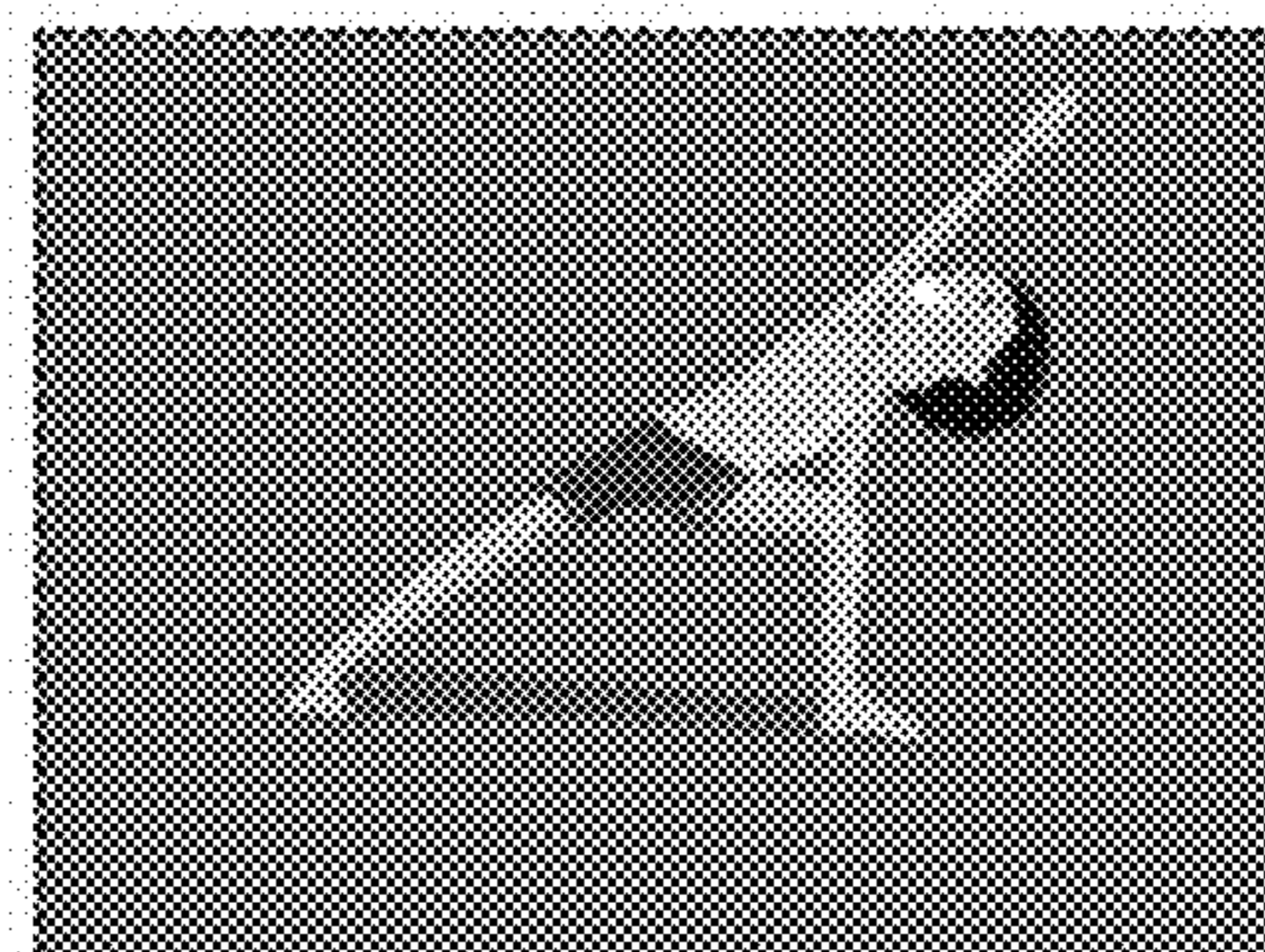

FIG. 8

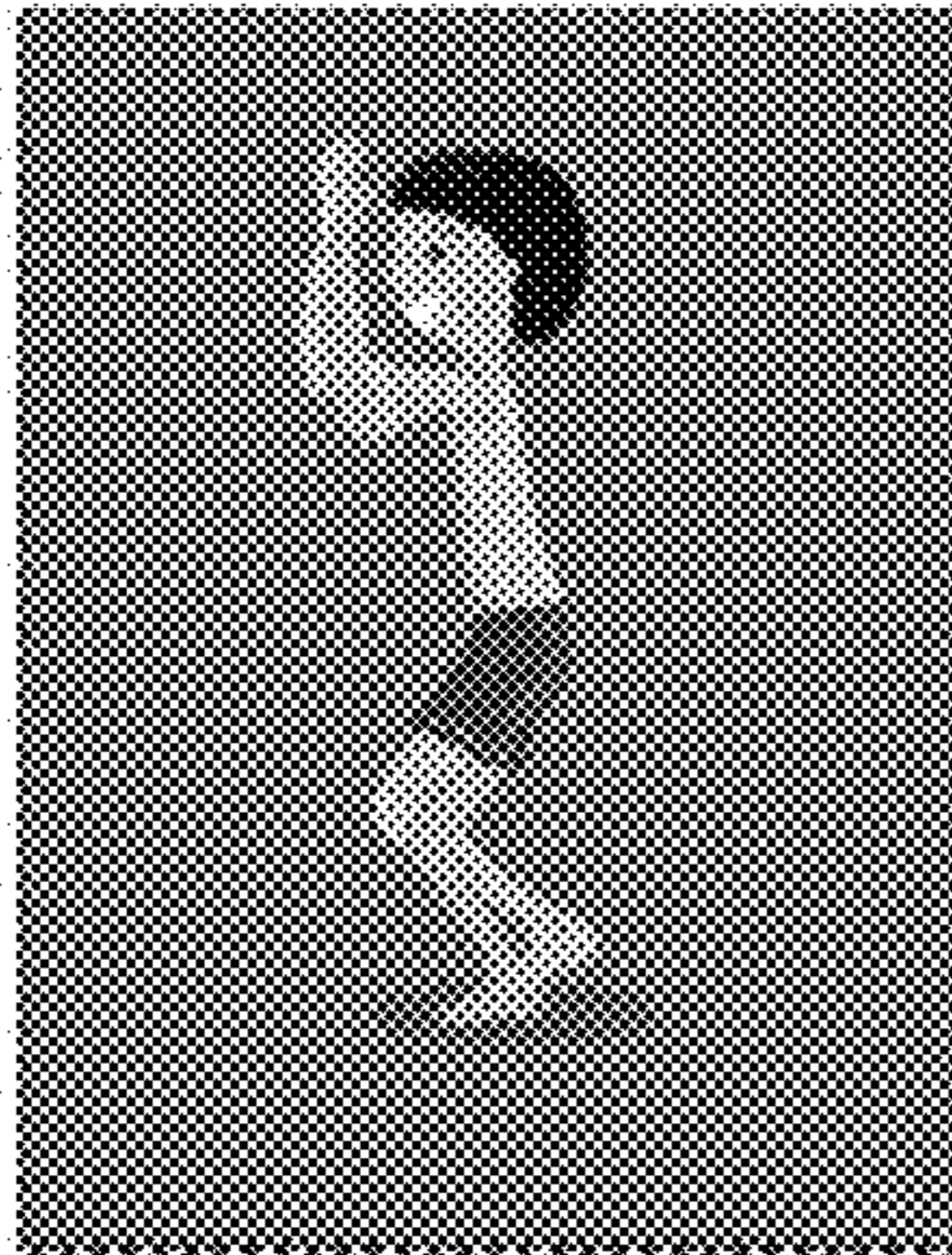

FIG. 9

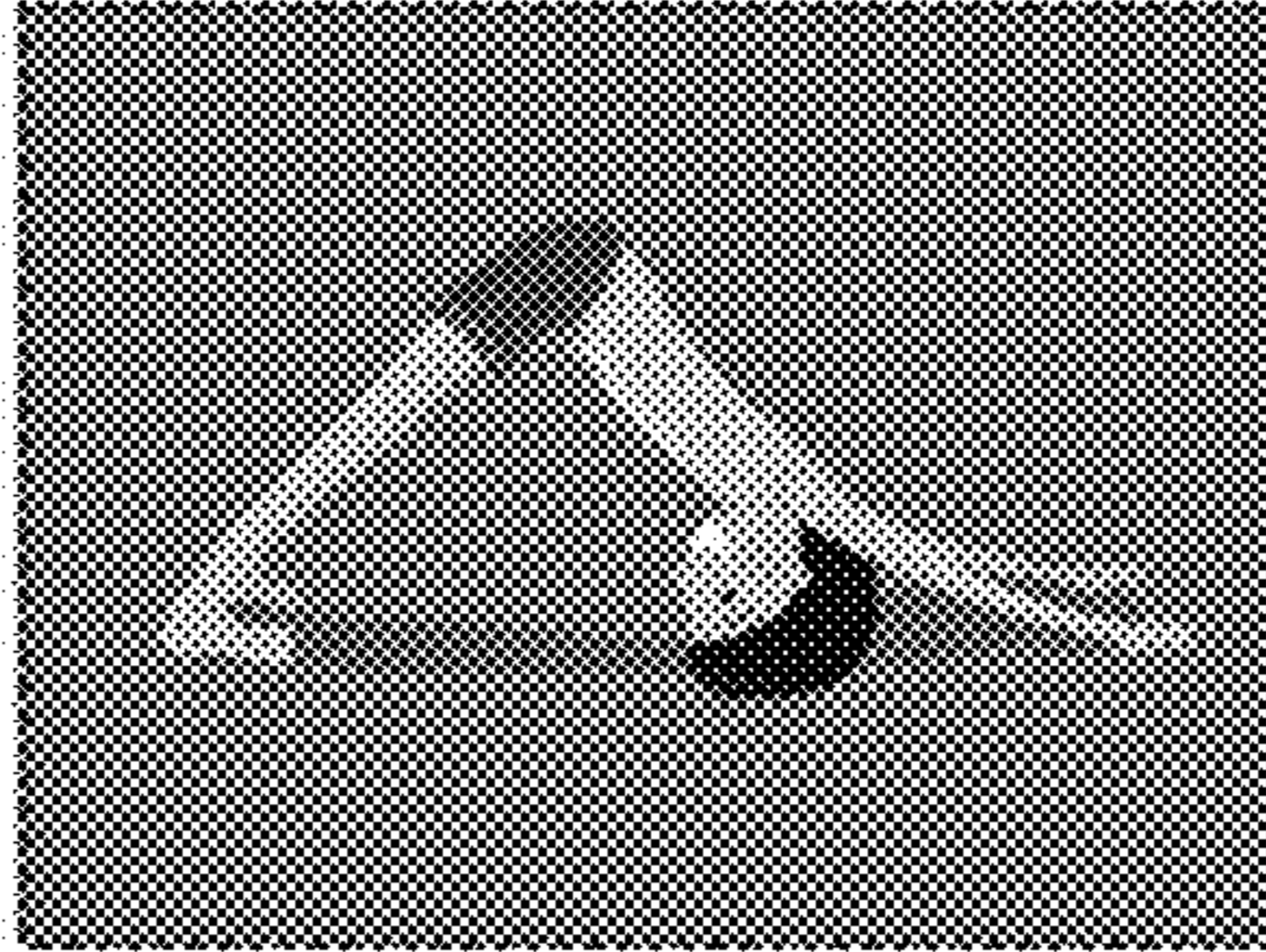

FIG. 10

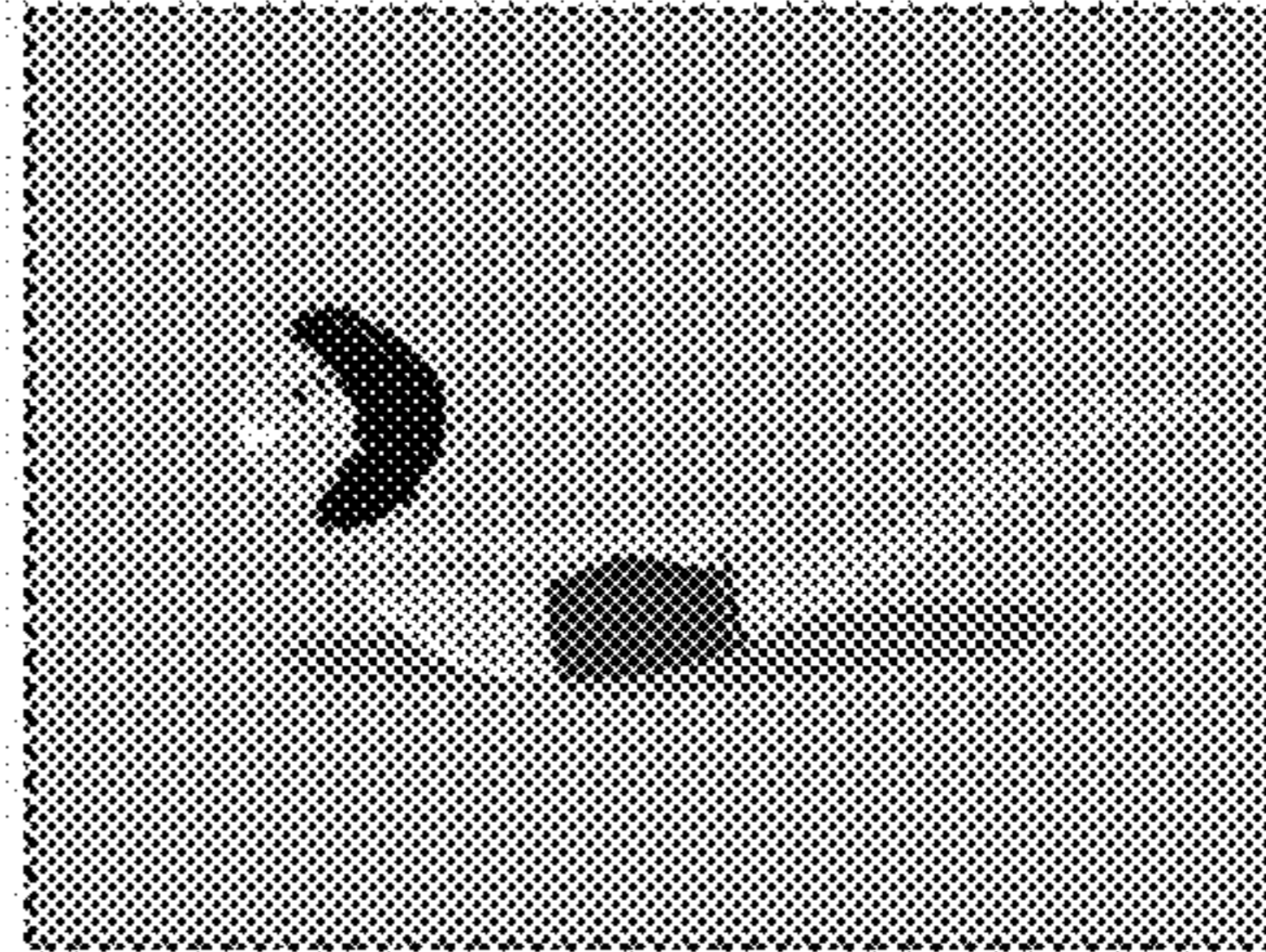

FIG. 11

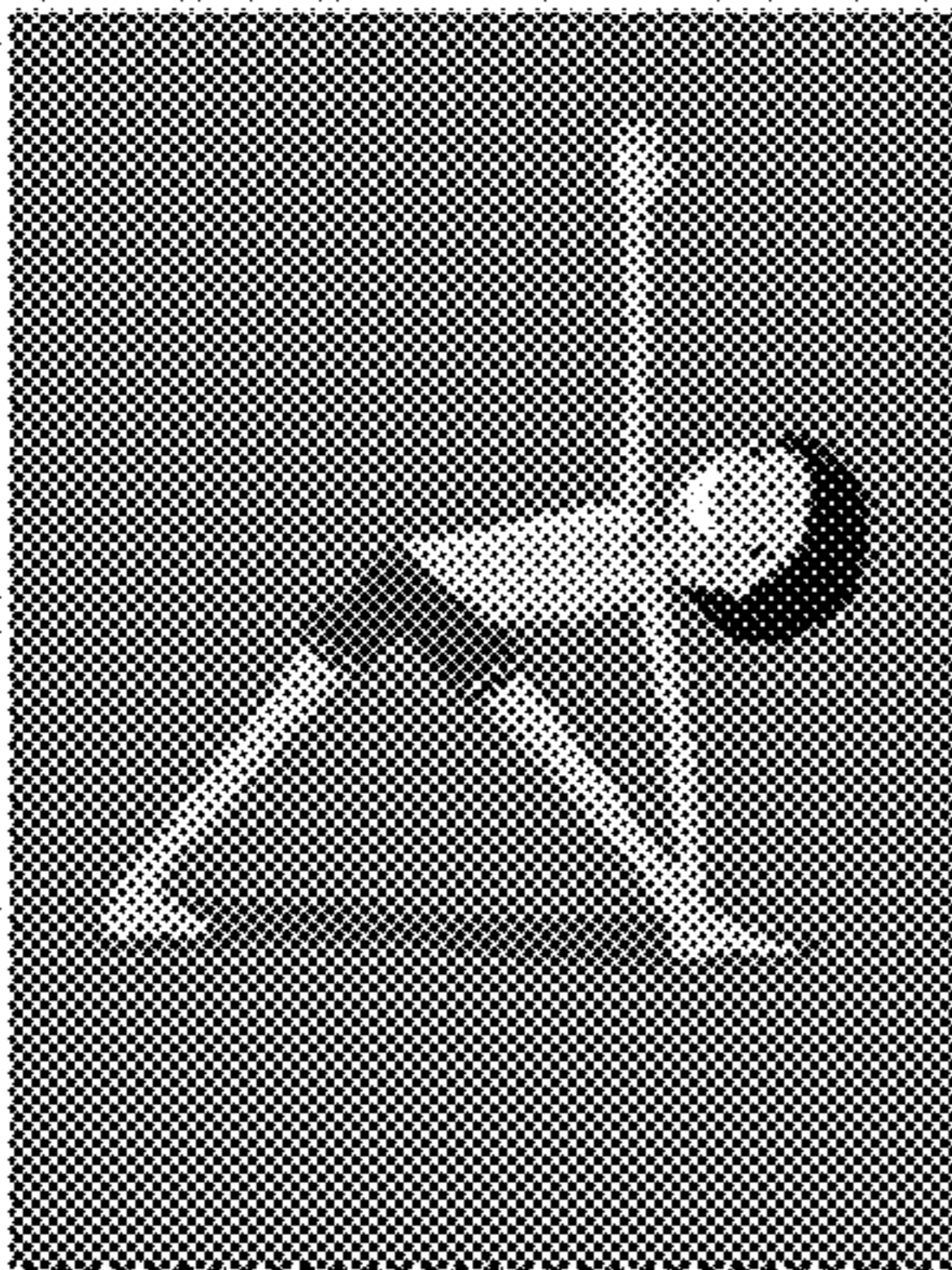

FIG. 12

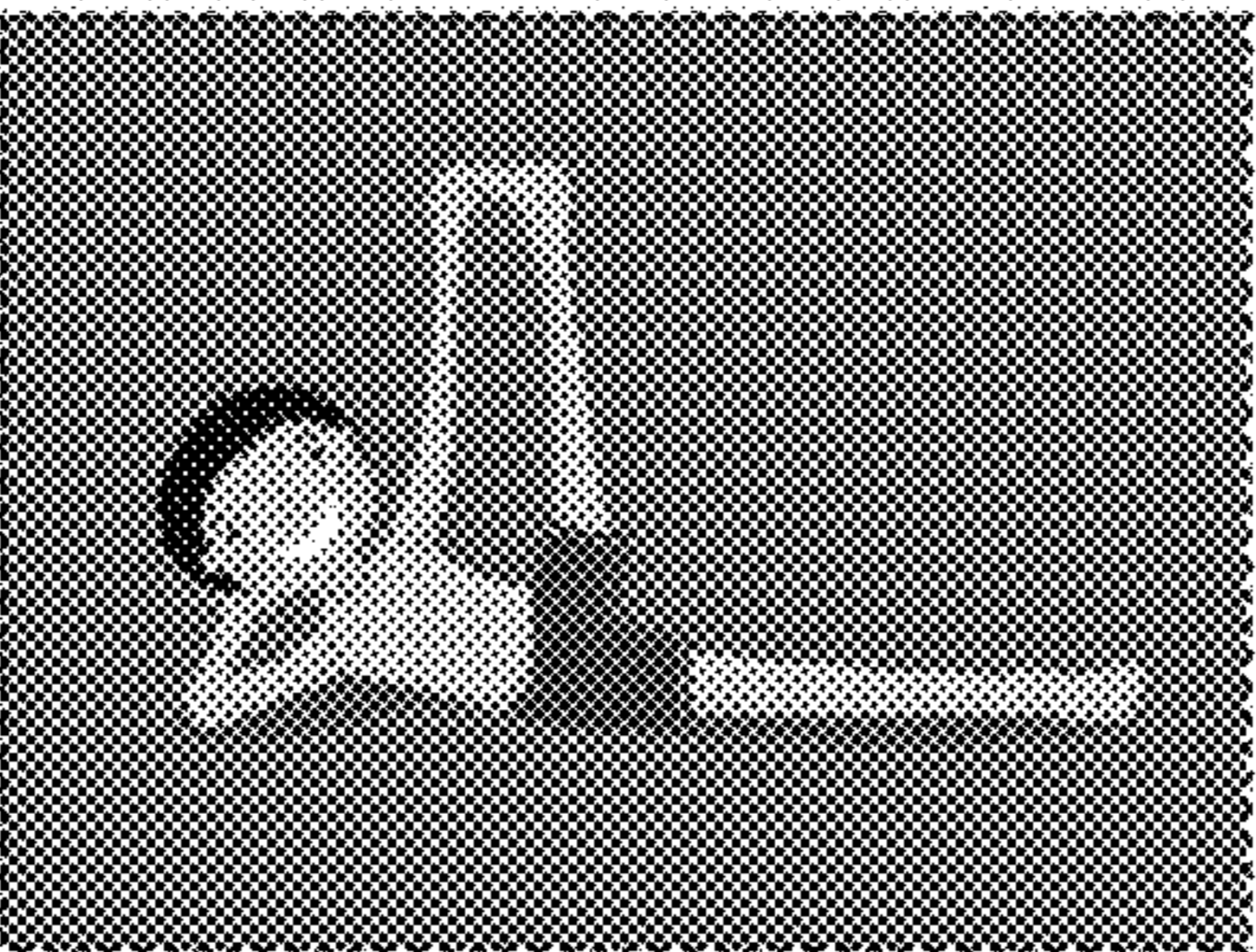

FIG. 13

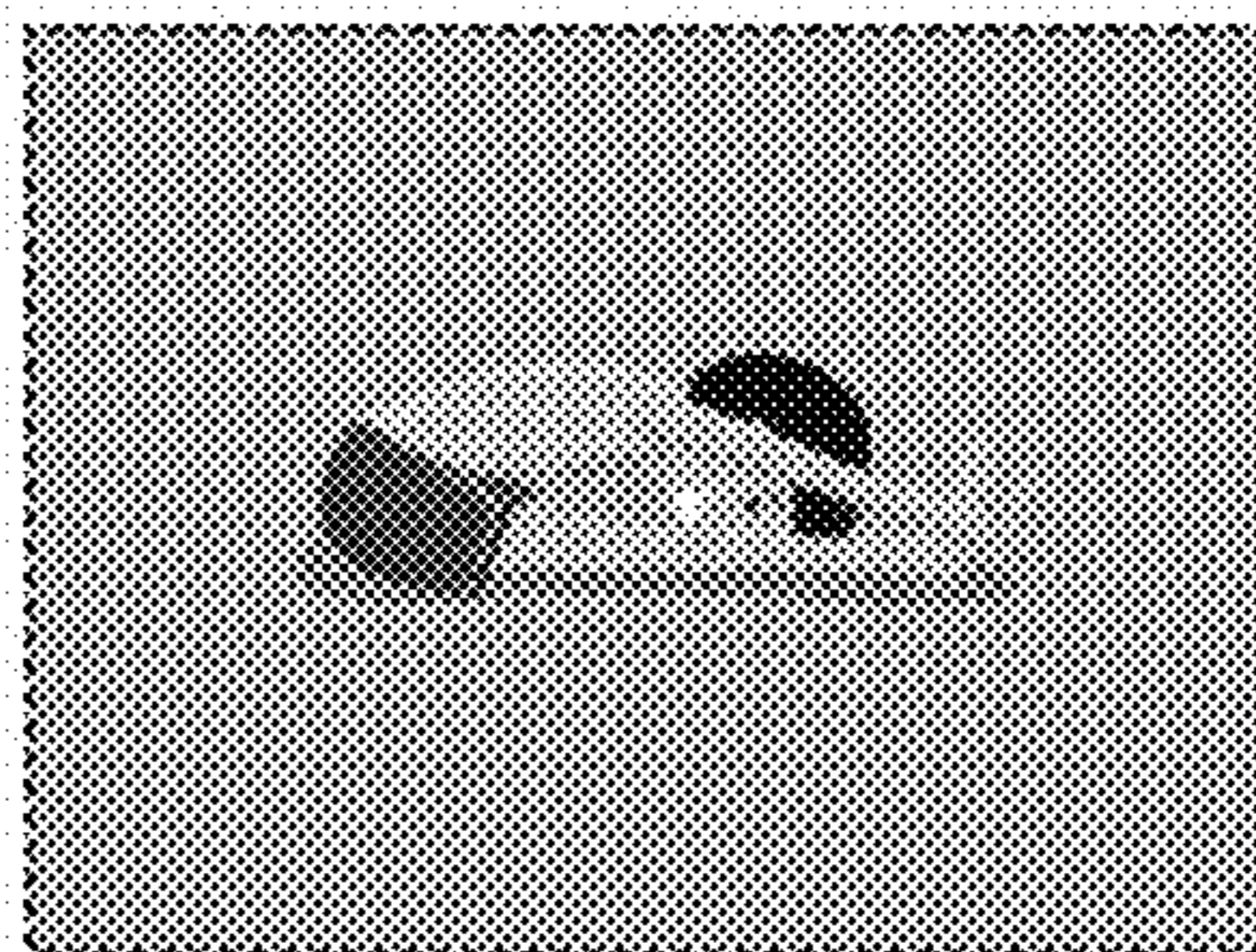

FIG. 14

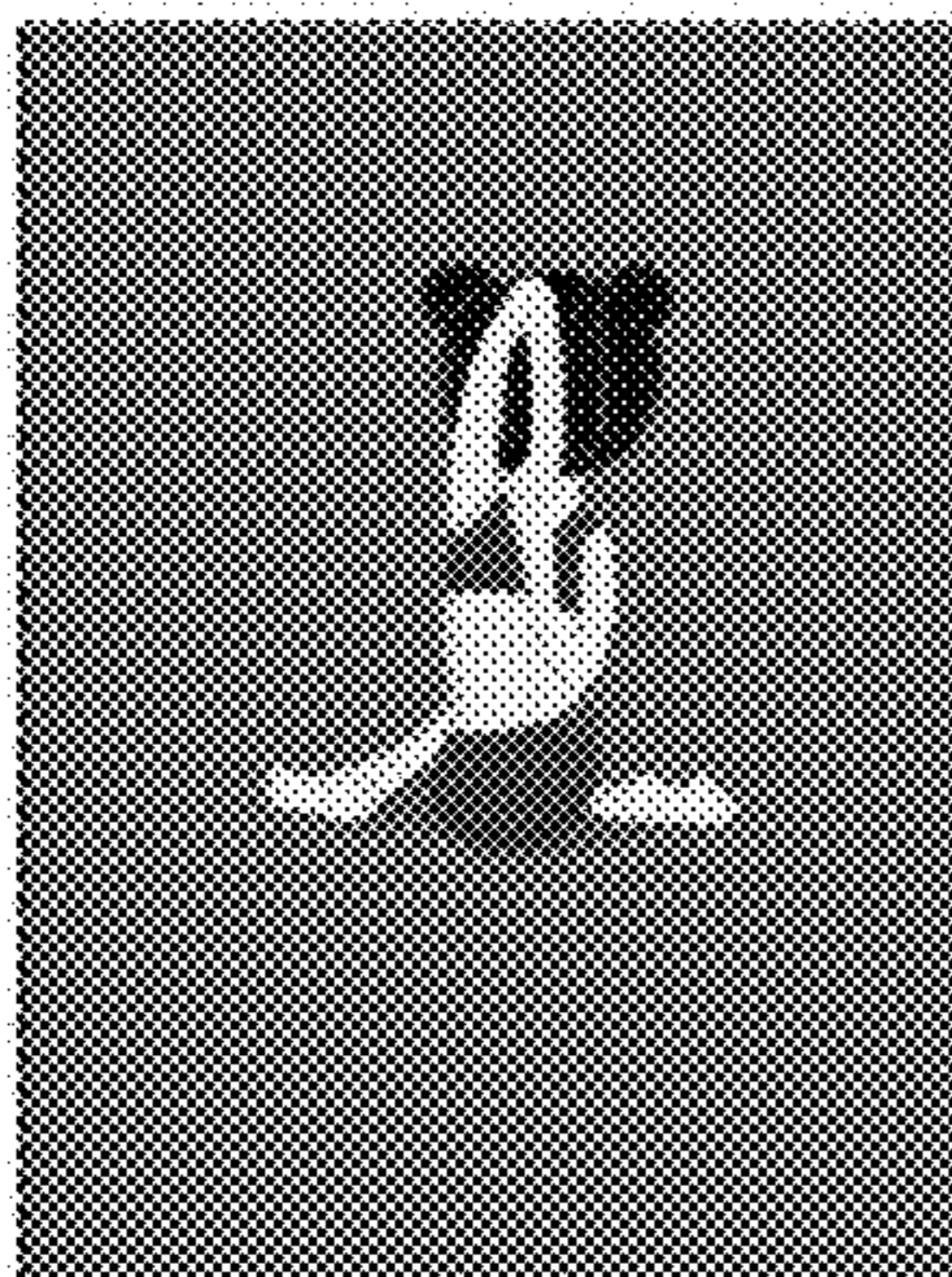

FIG. 15

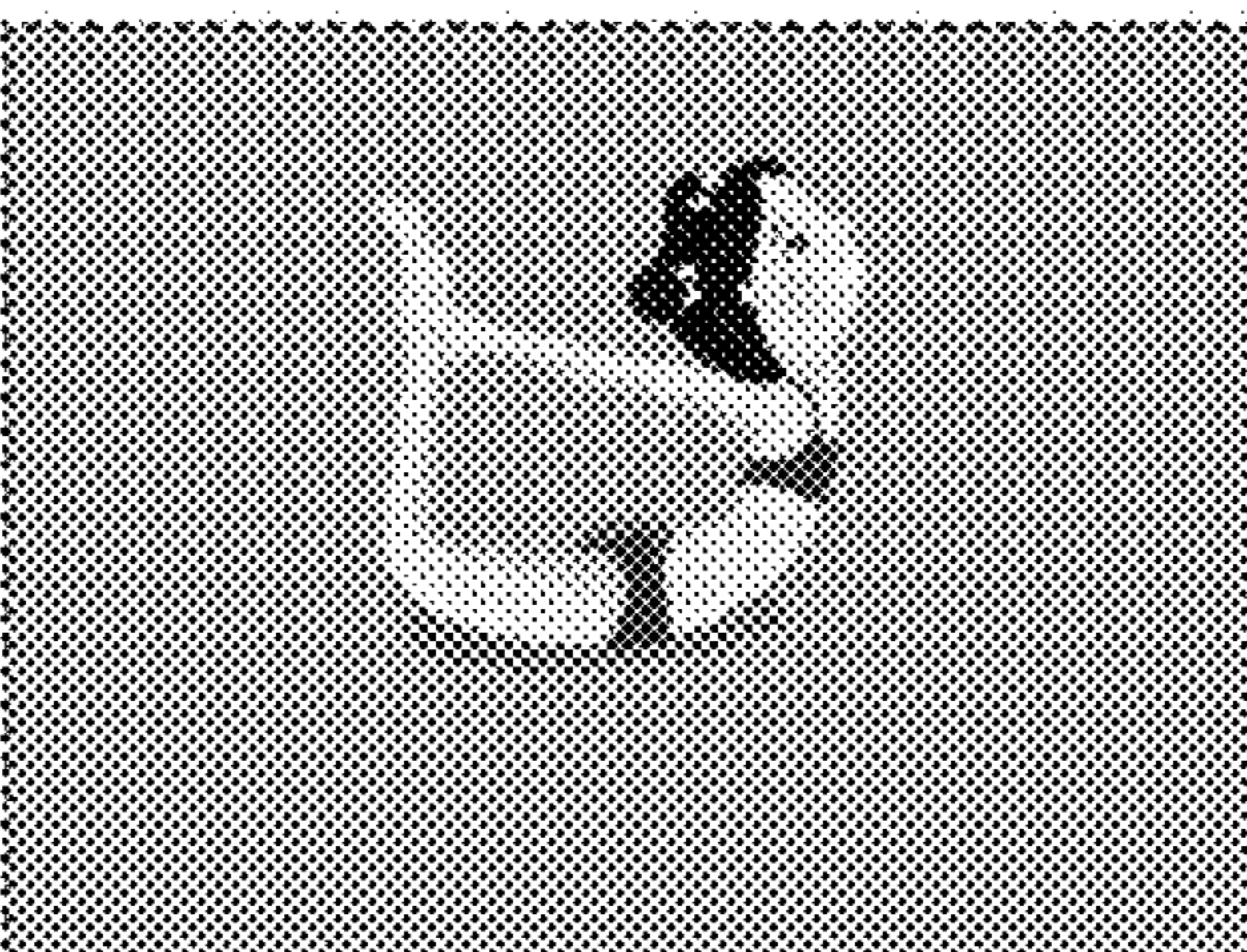

FIG. 16

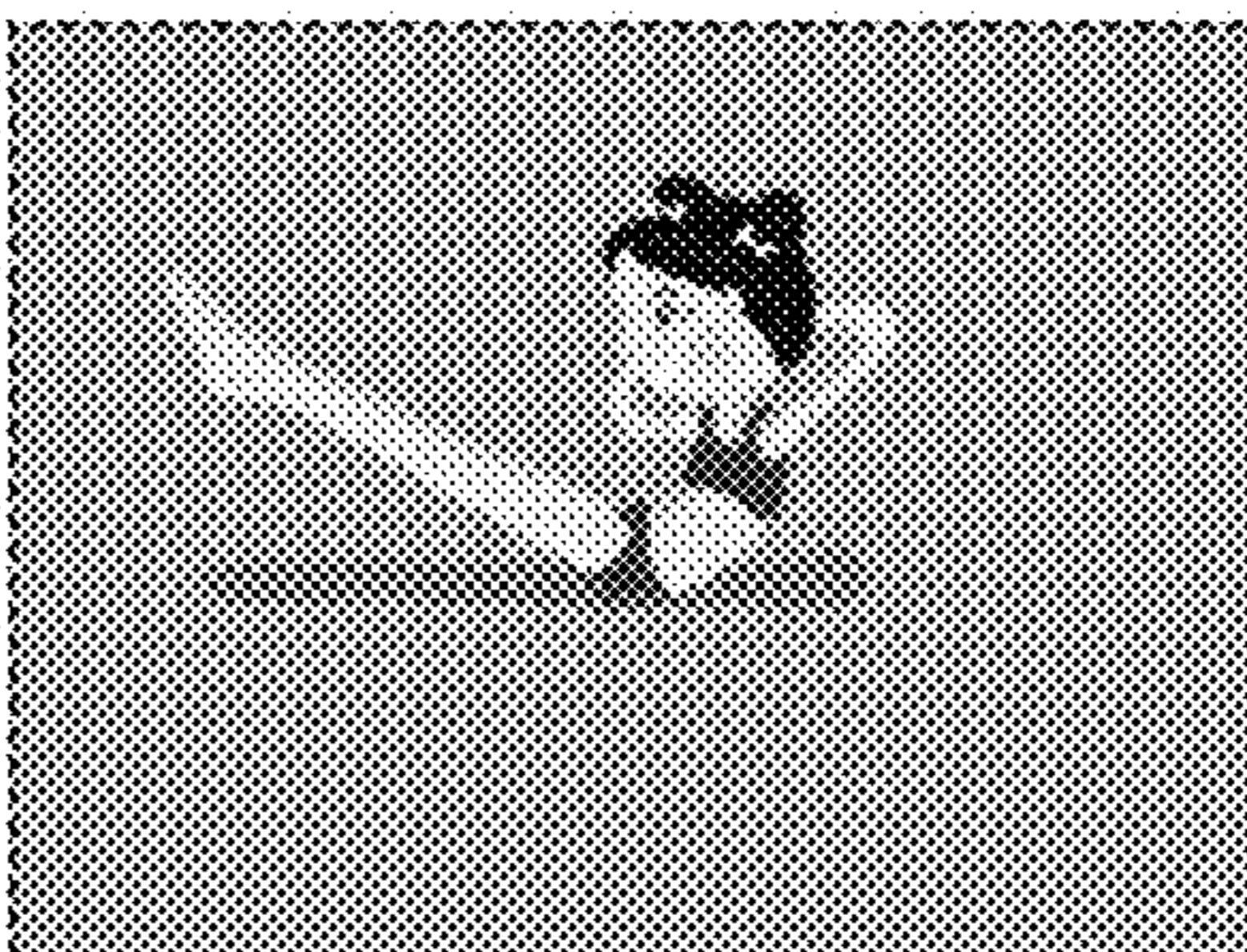

FIG. 17

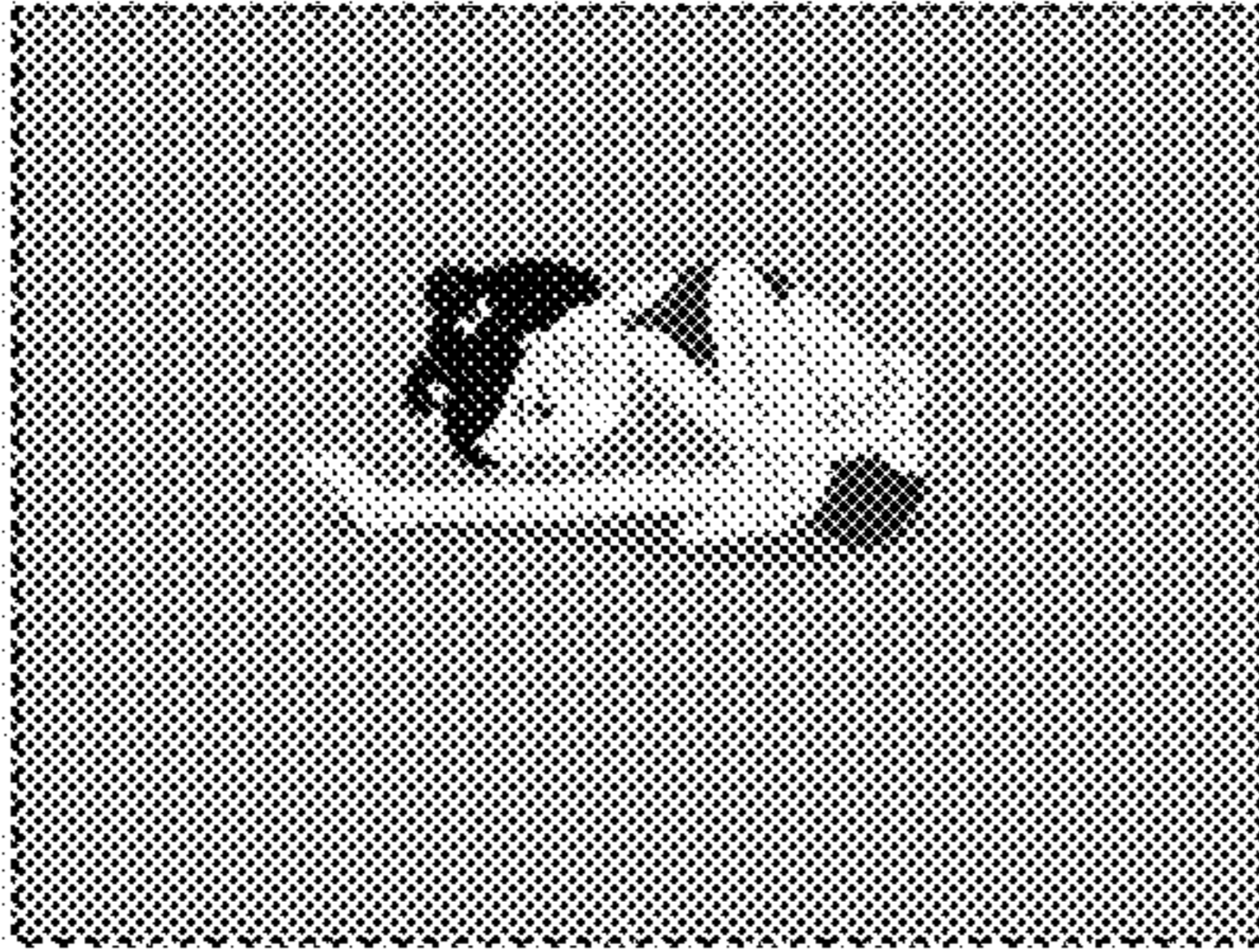

FIG. 18

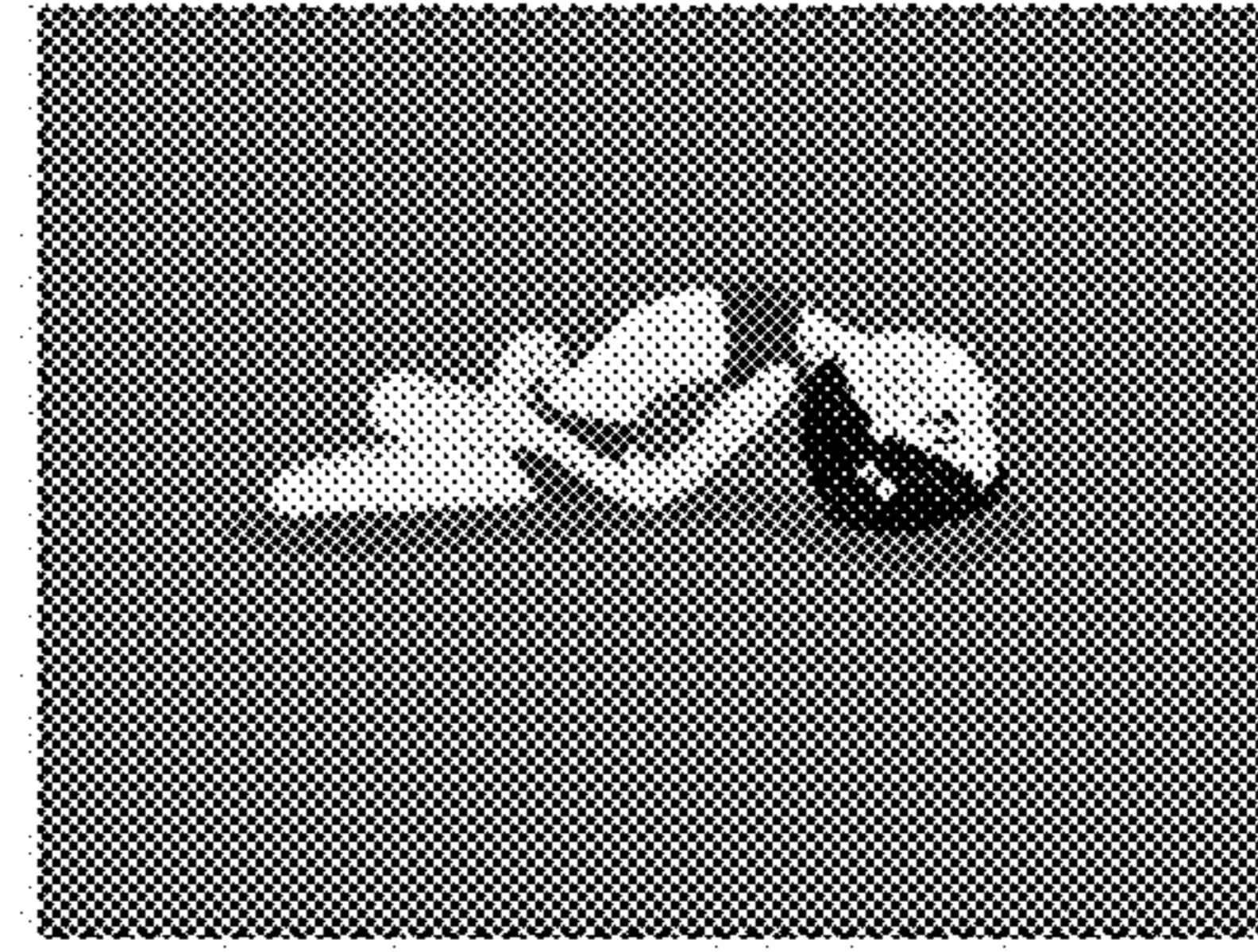

FIG. 19

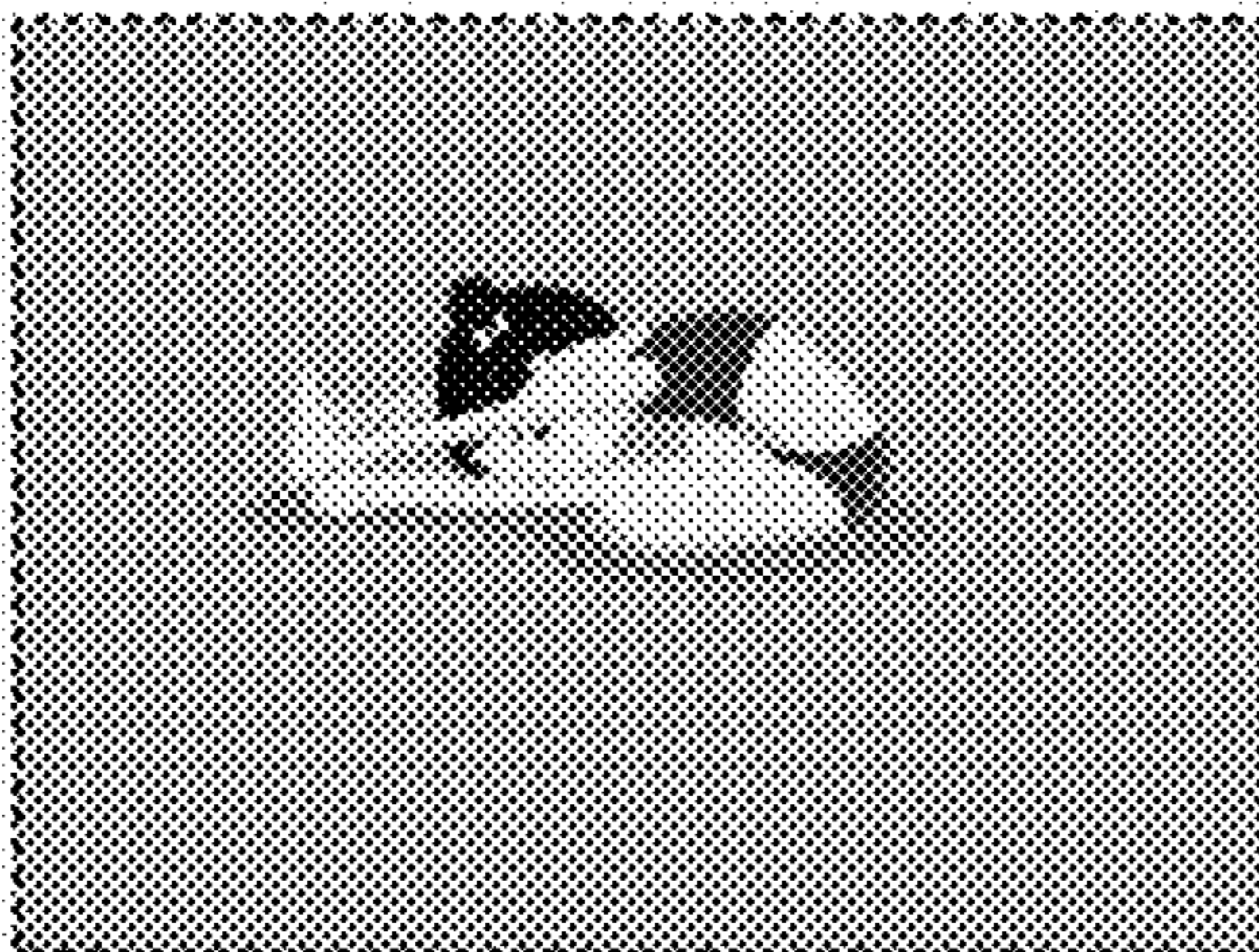

FIG. 20

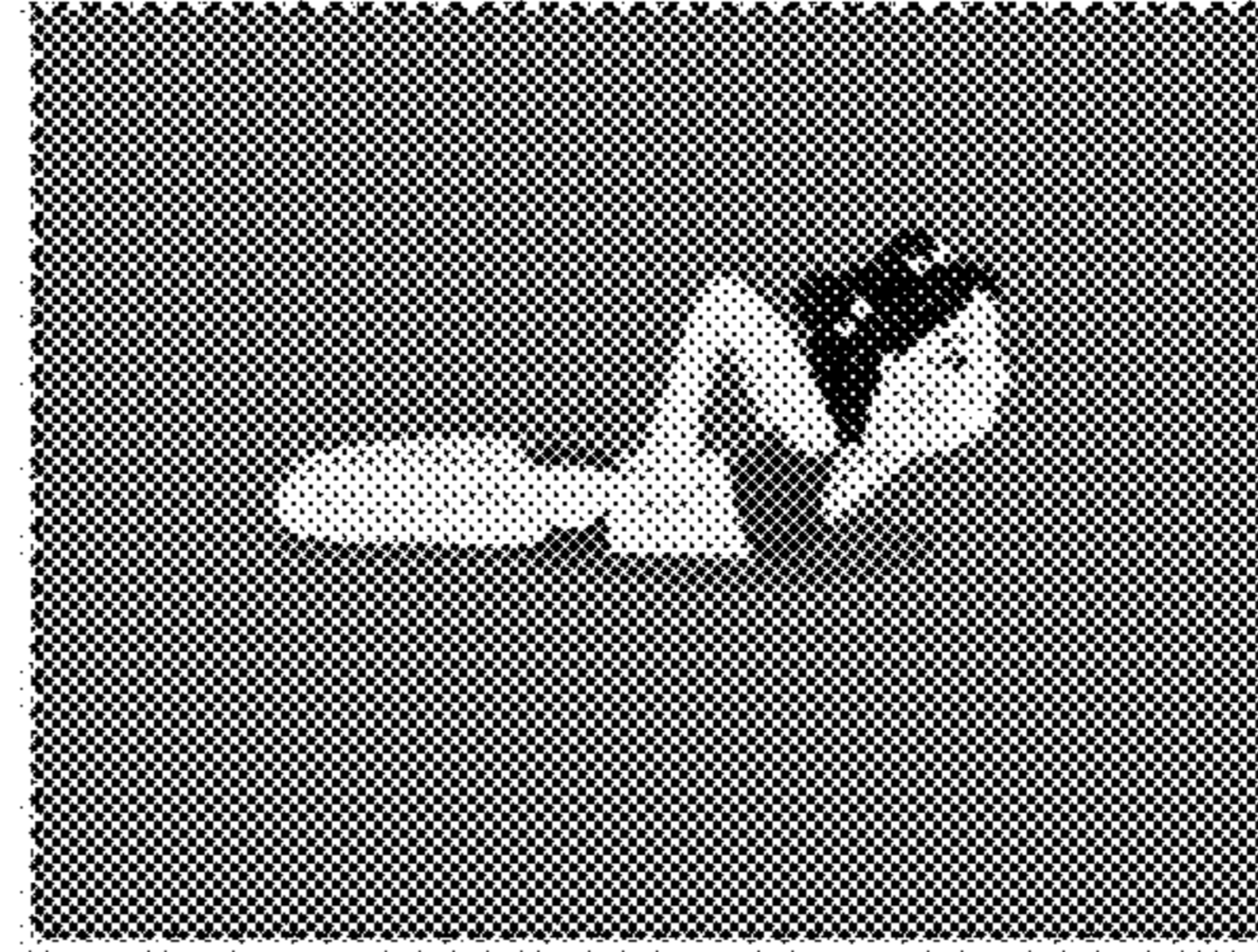

FIG. 21

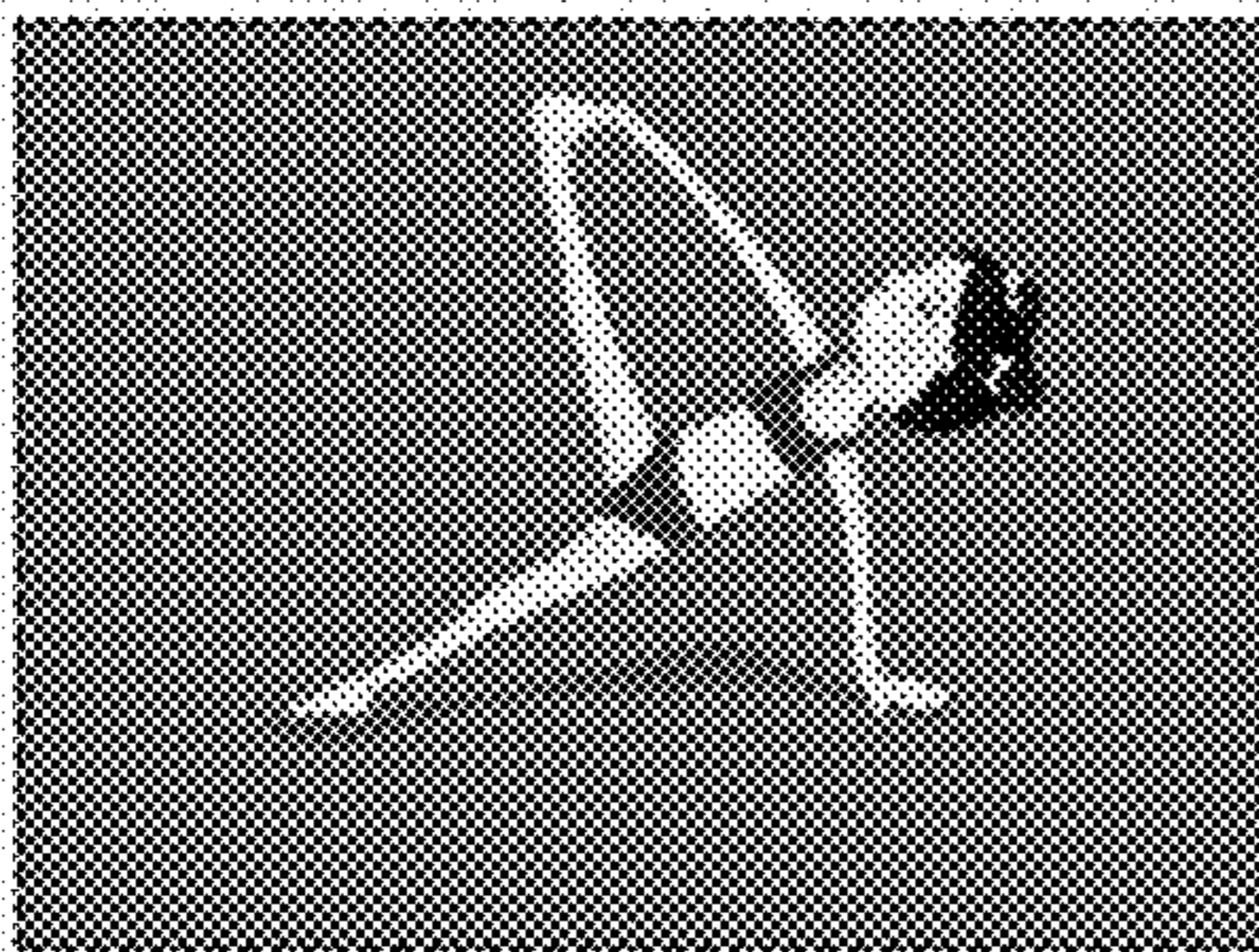

FIG. 22

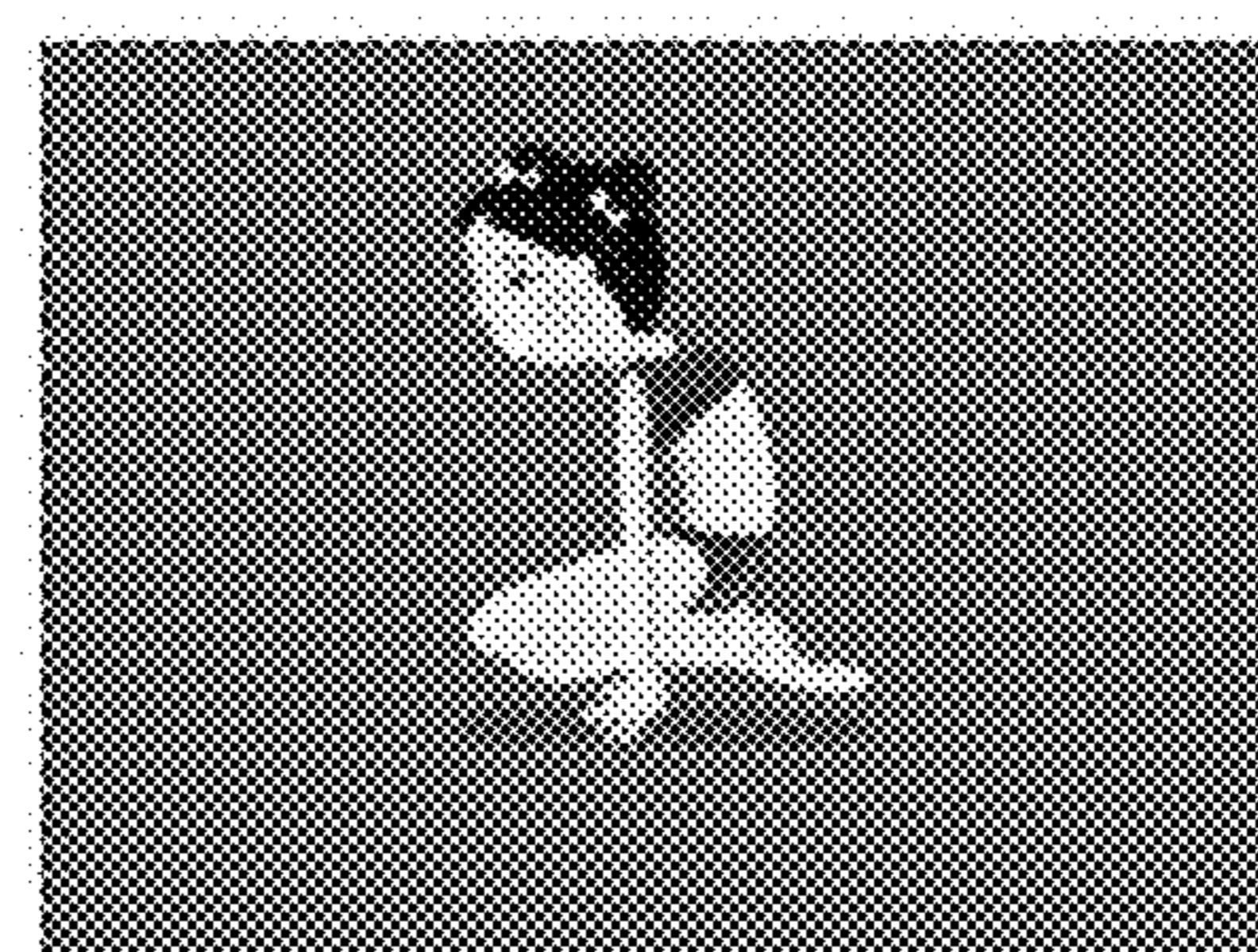

FIG. 23

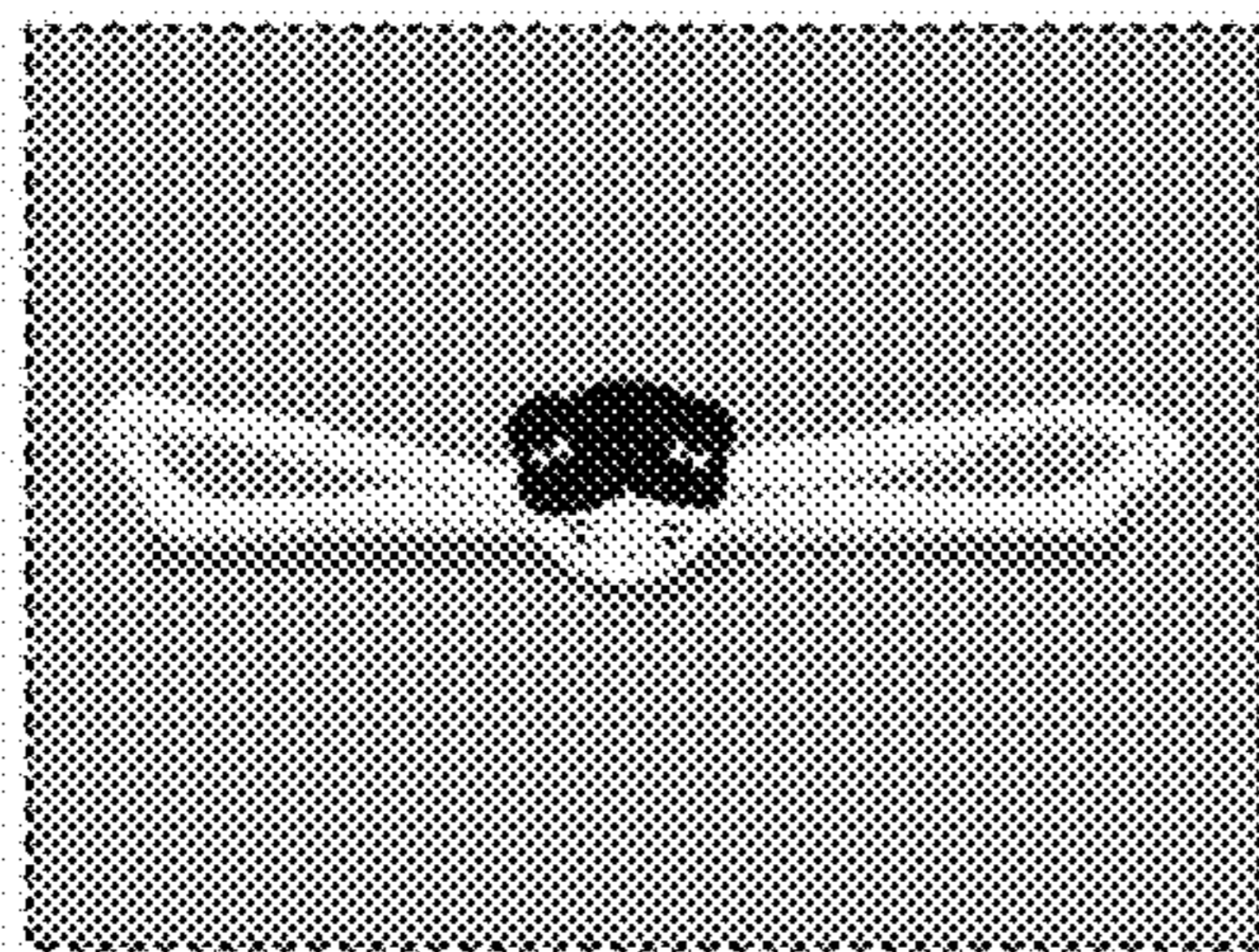

FIG. 24

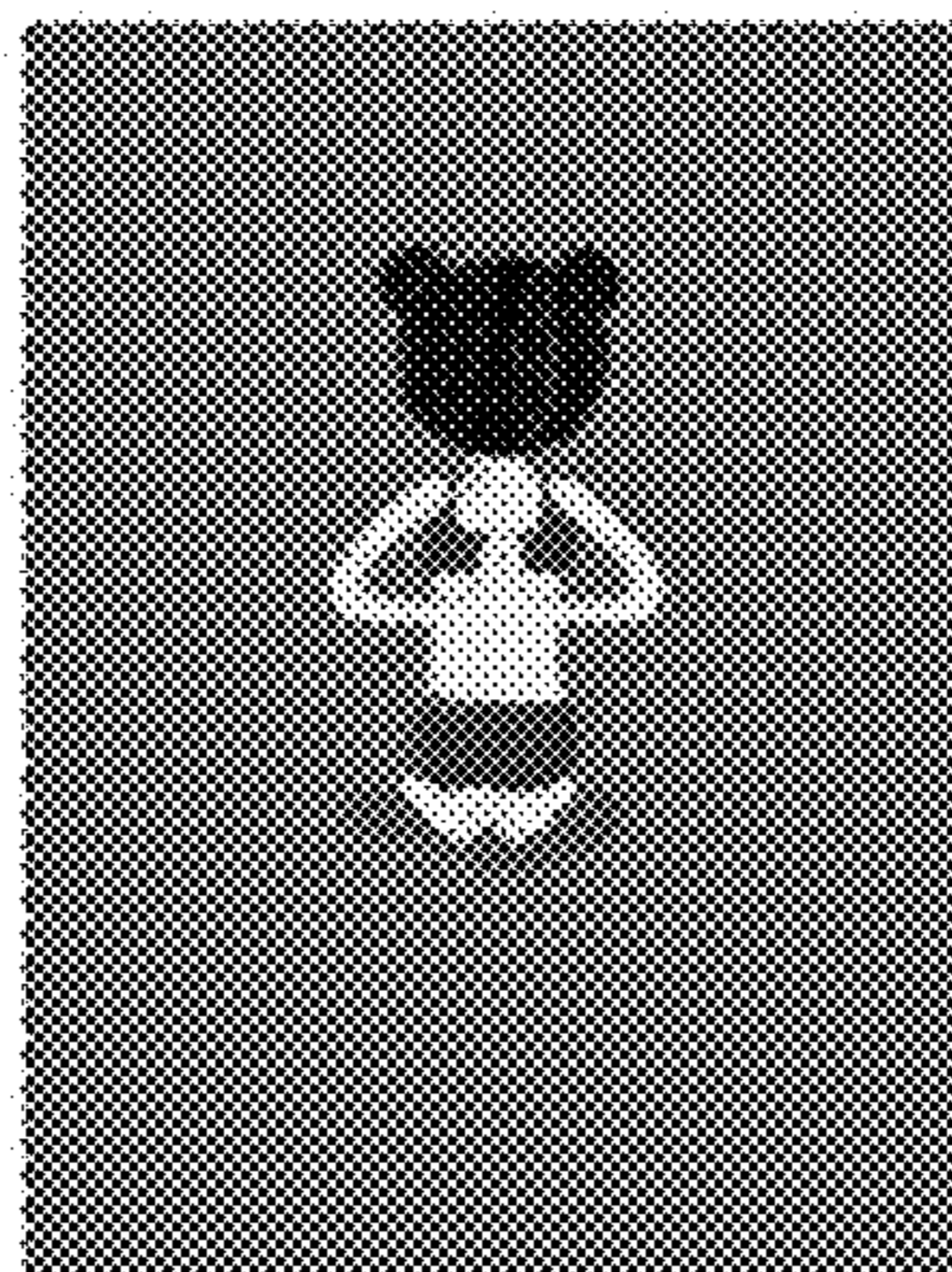

FIG. 25

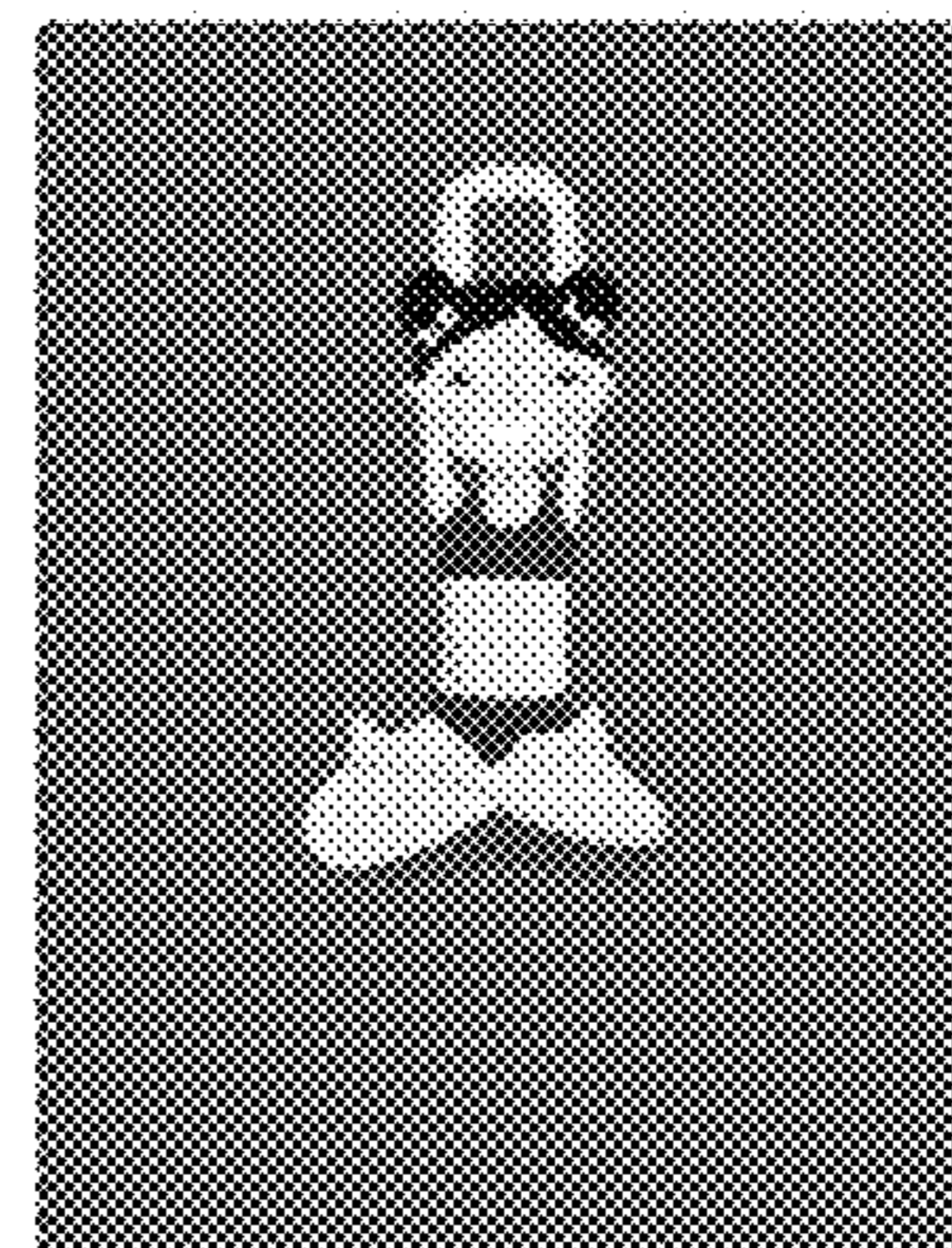

FIG. 26

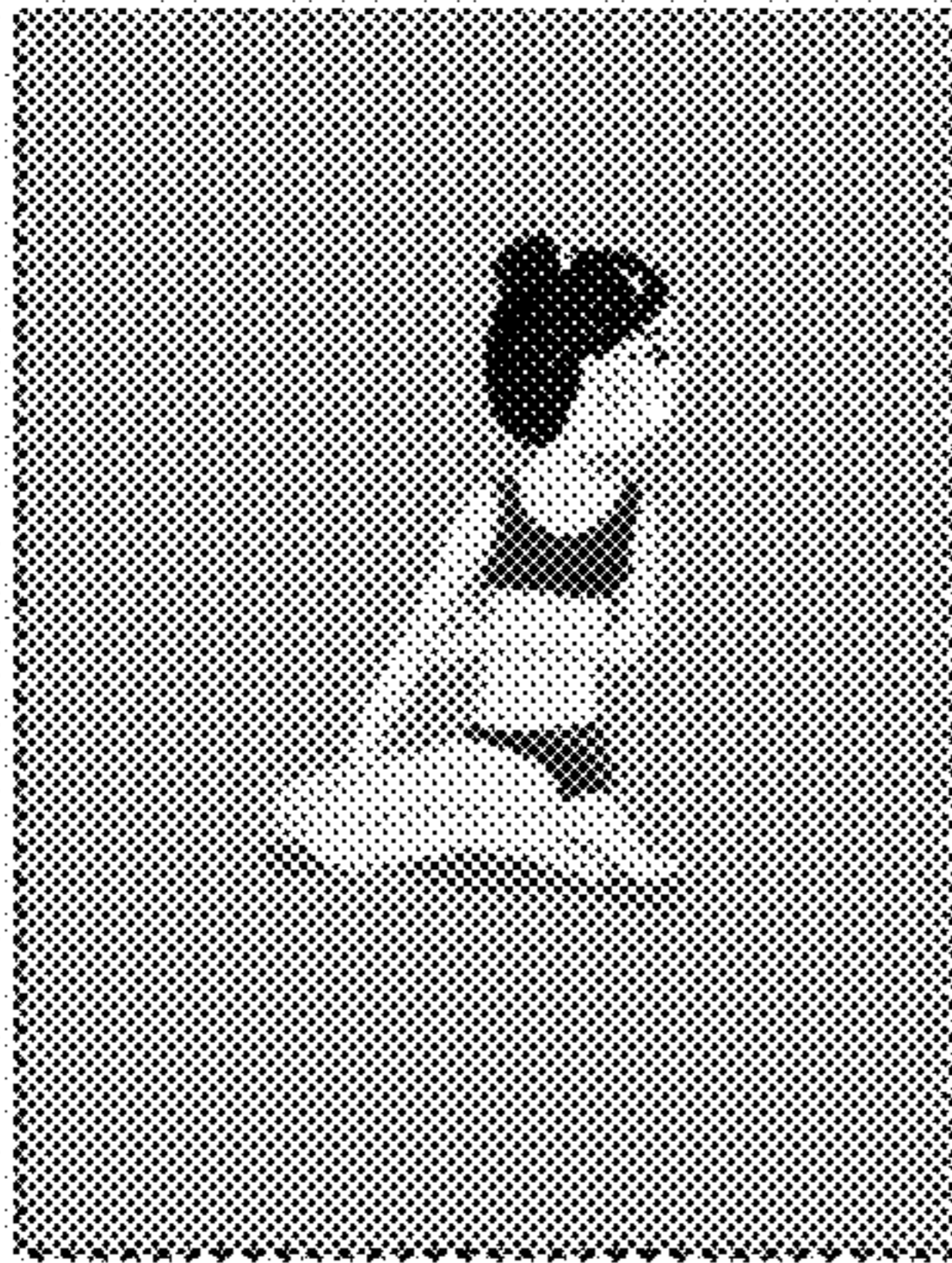

FIG. 27

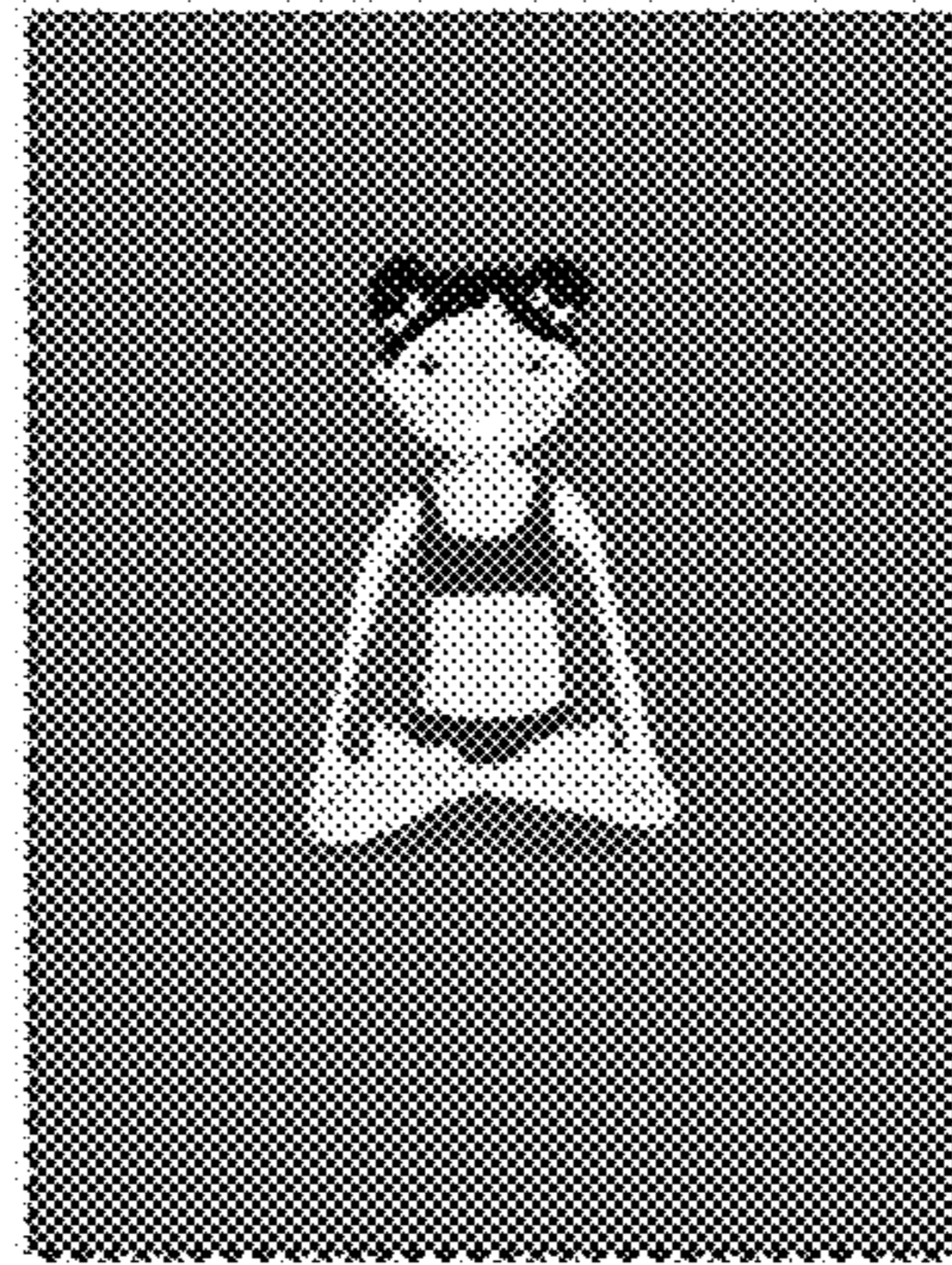

FIG. 28

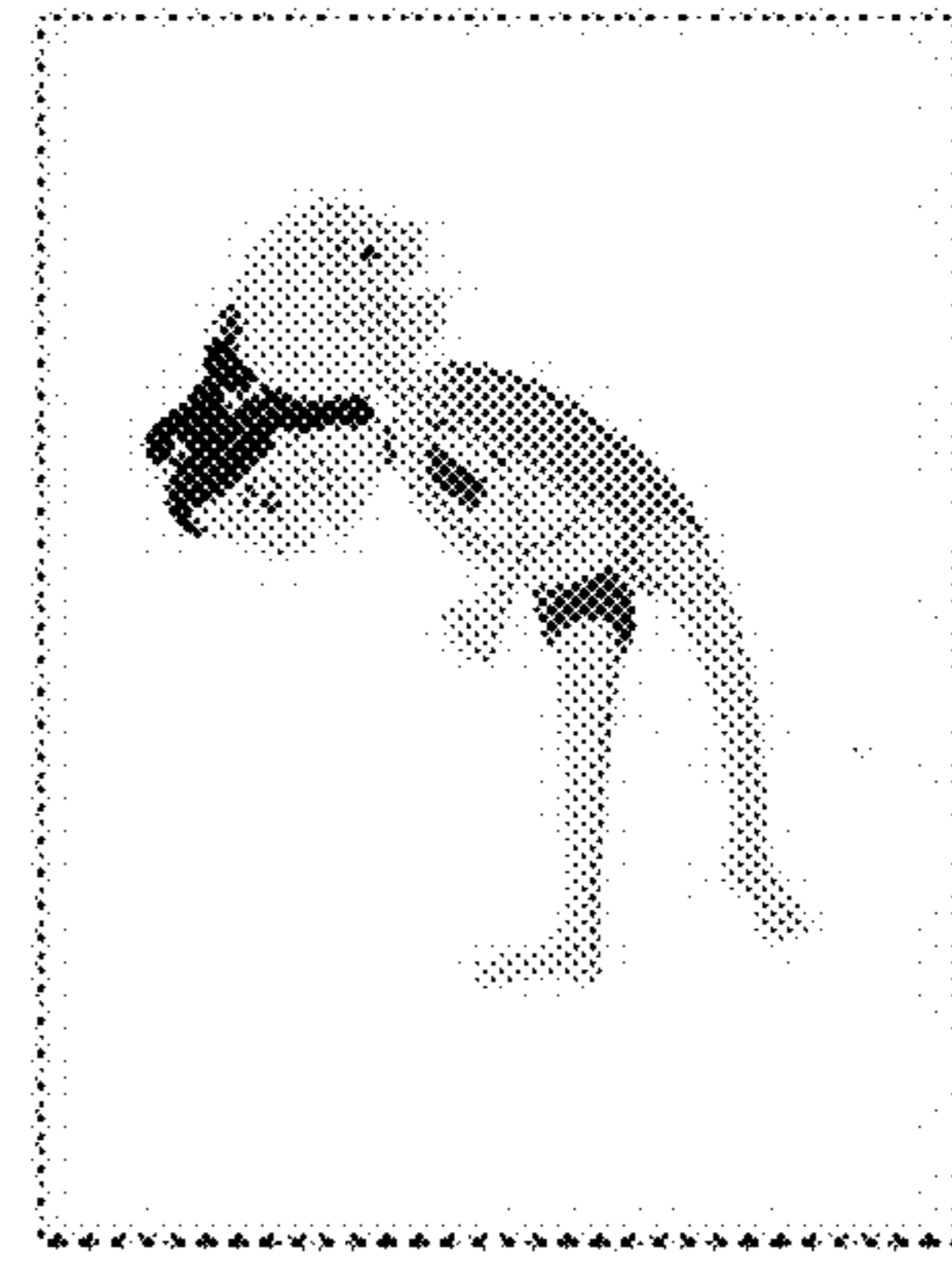

FIG. 29

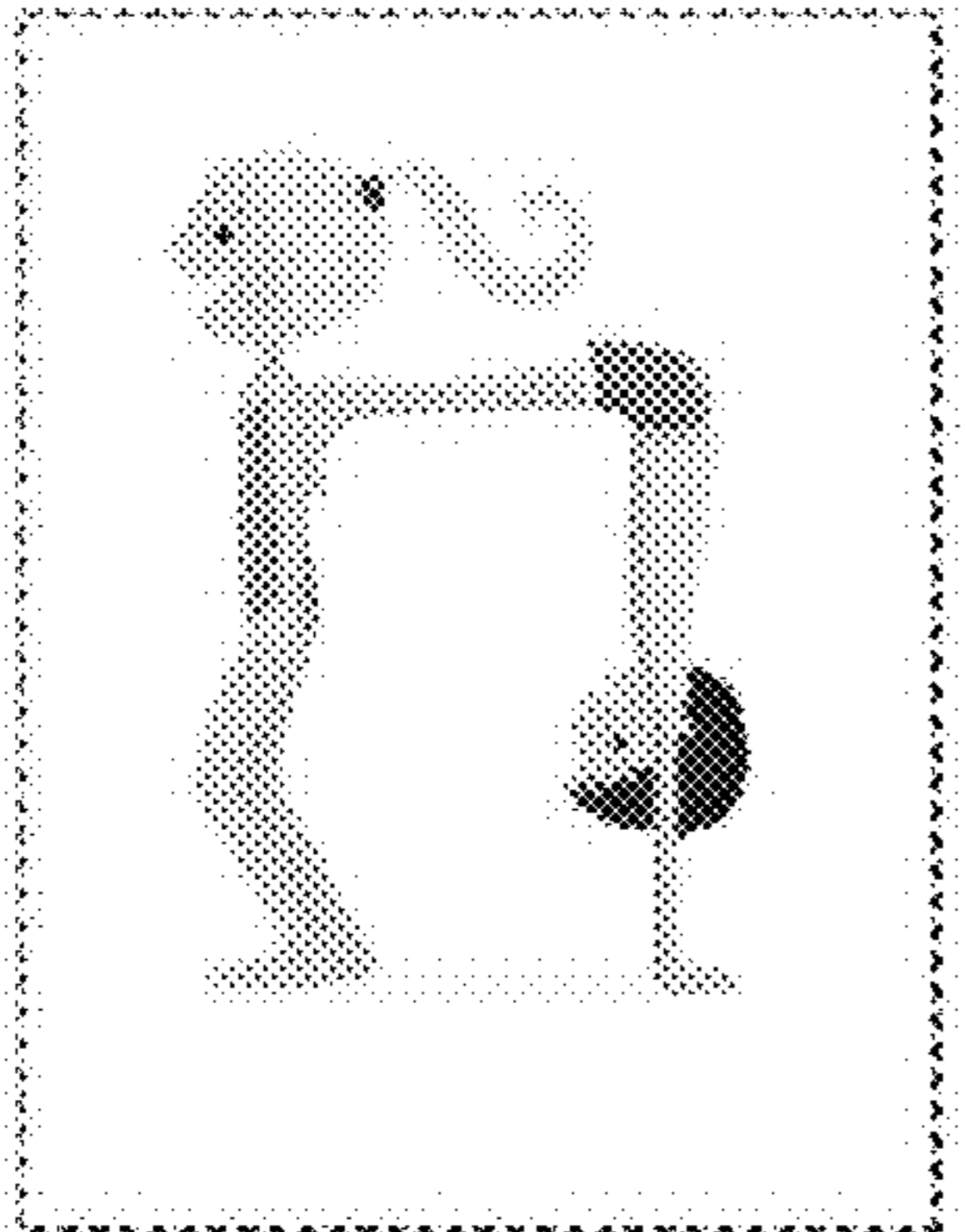

FIG. 30

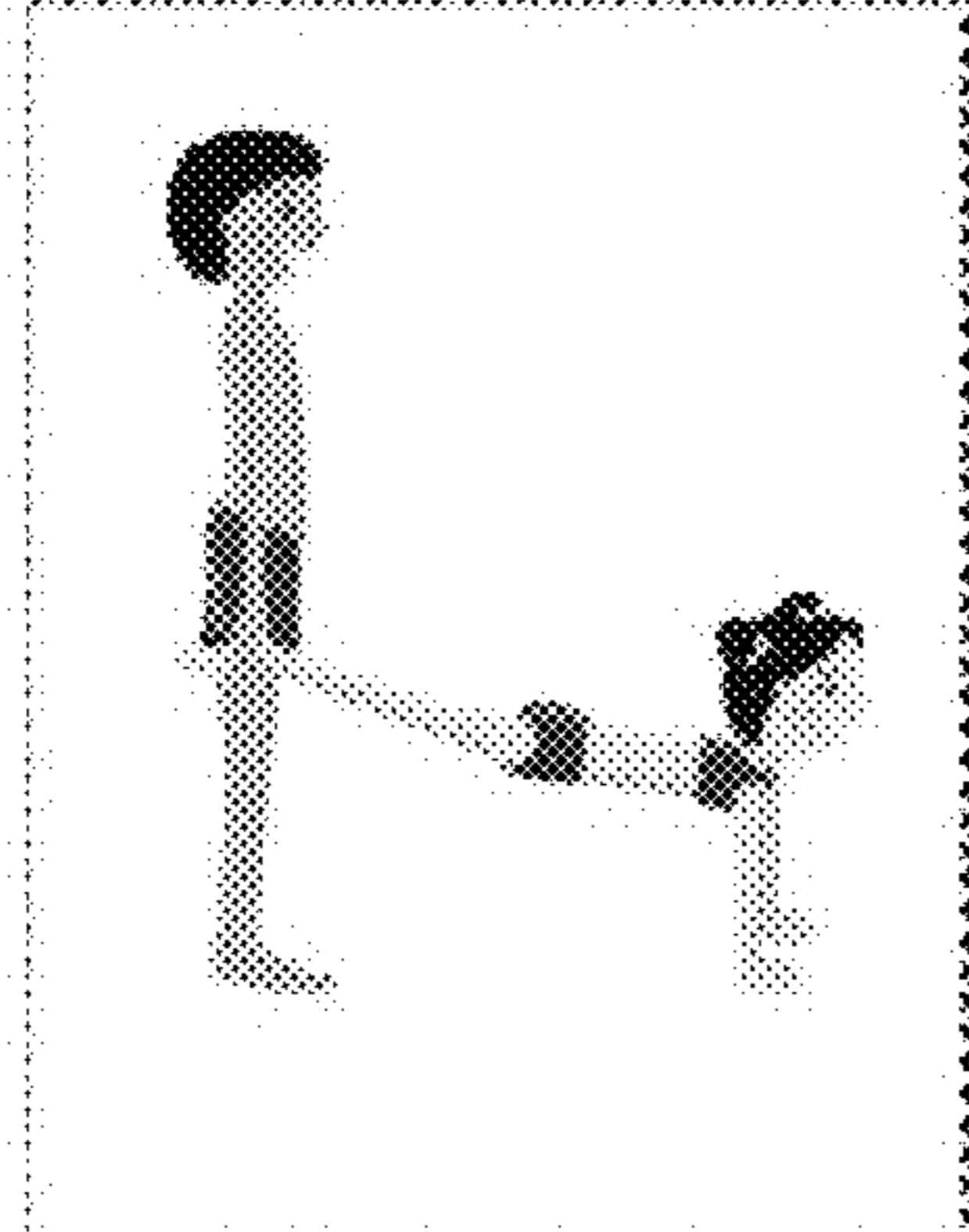

FIG. 31

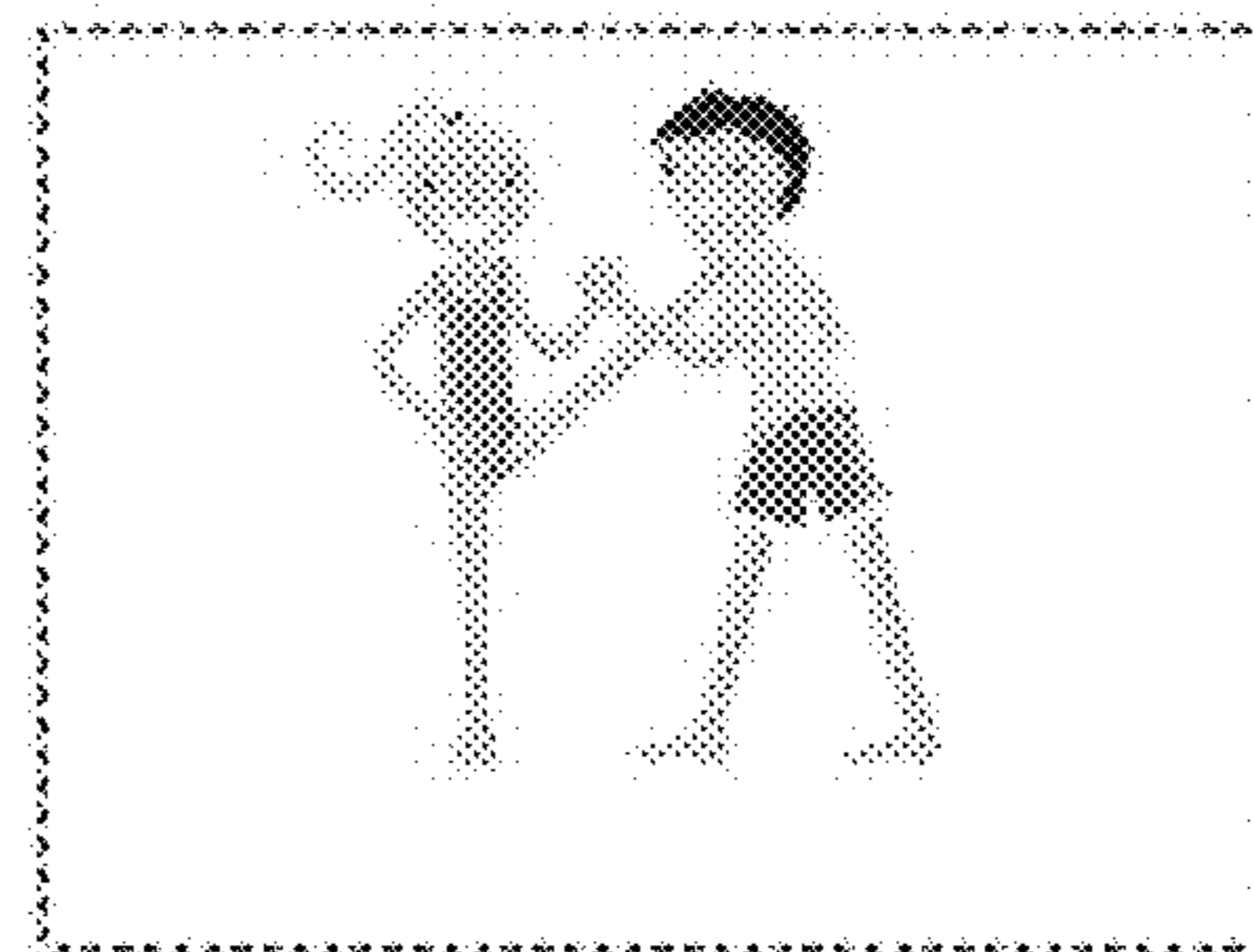

FIG. 32

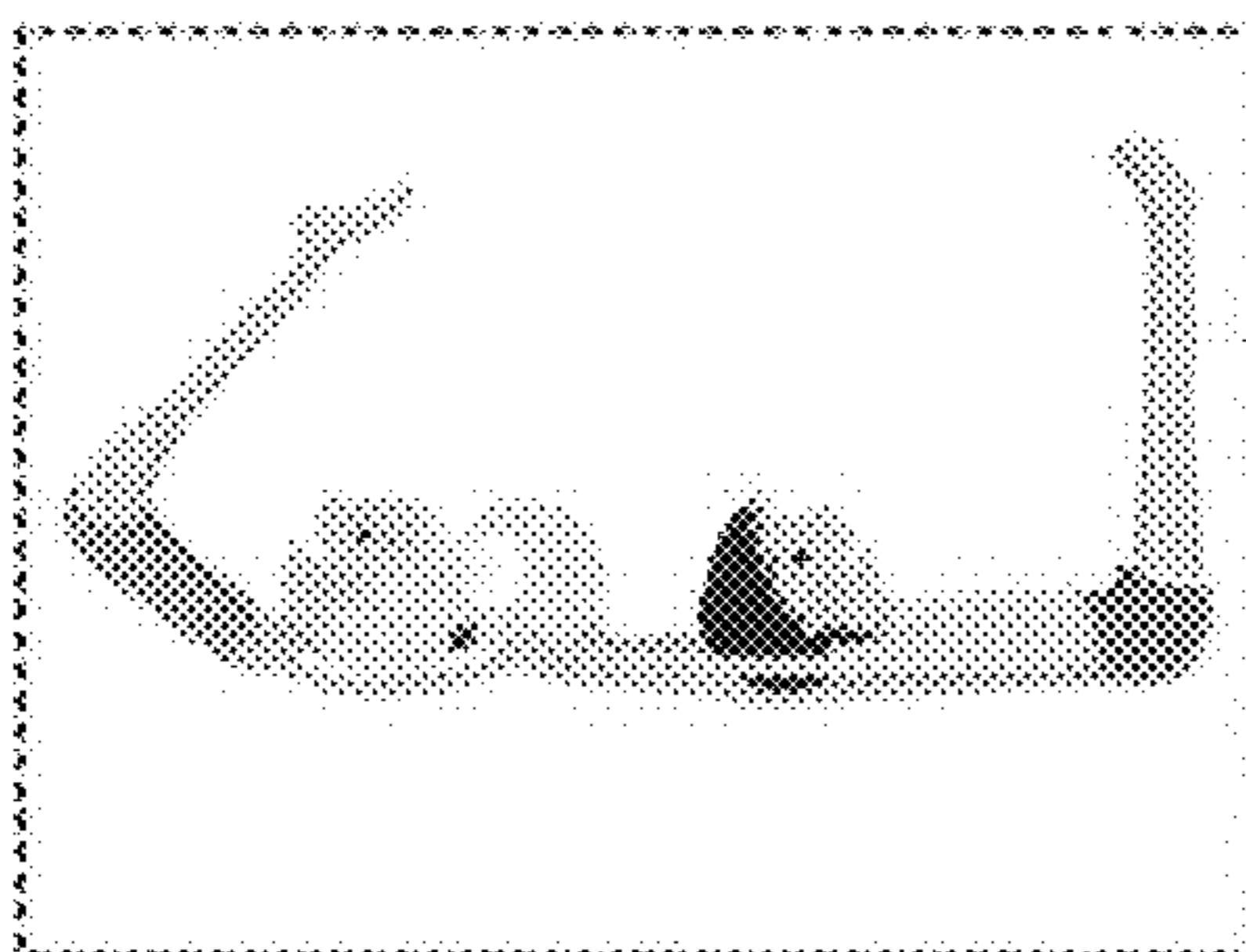

FIG. 34

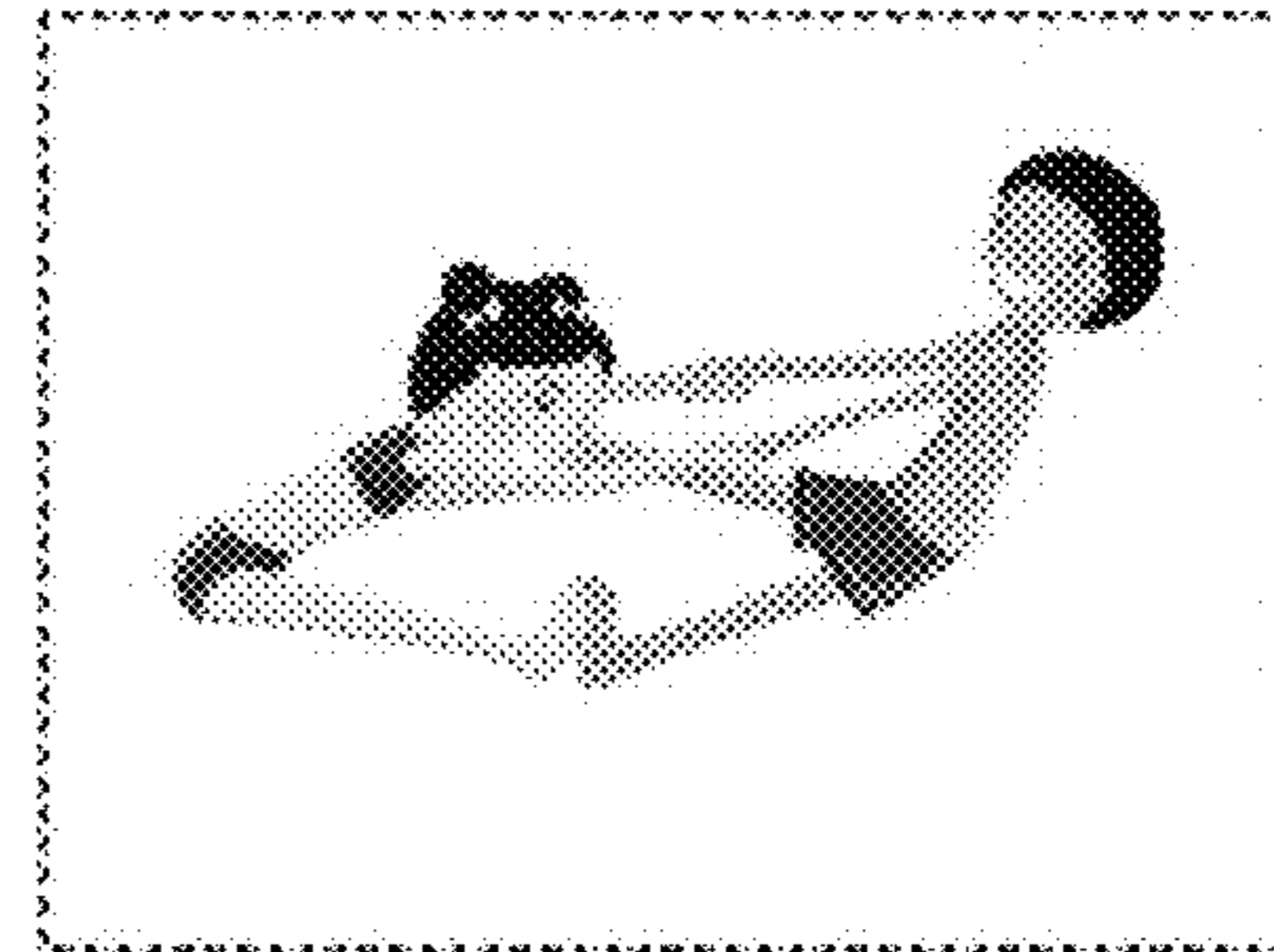

FIG. 33

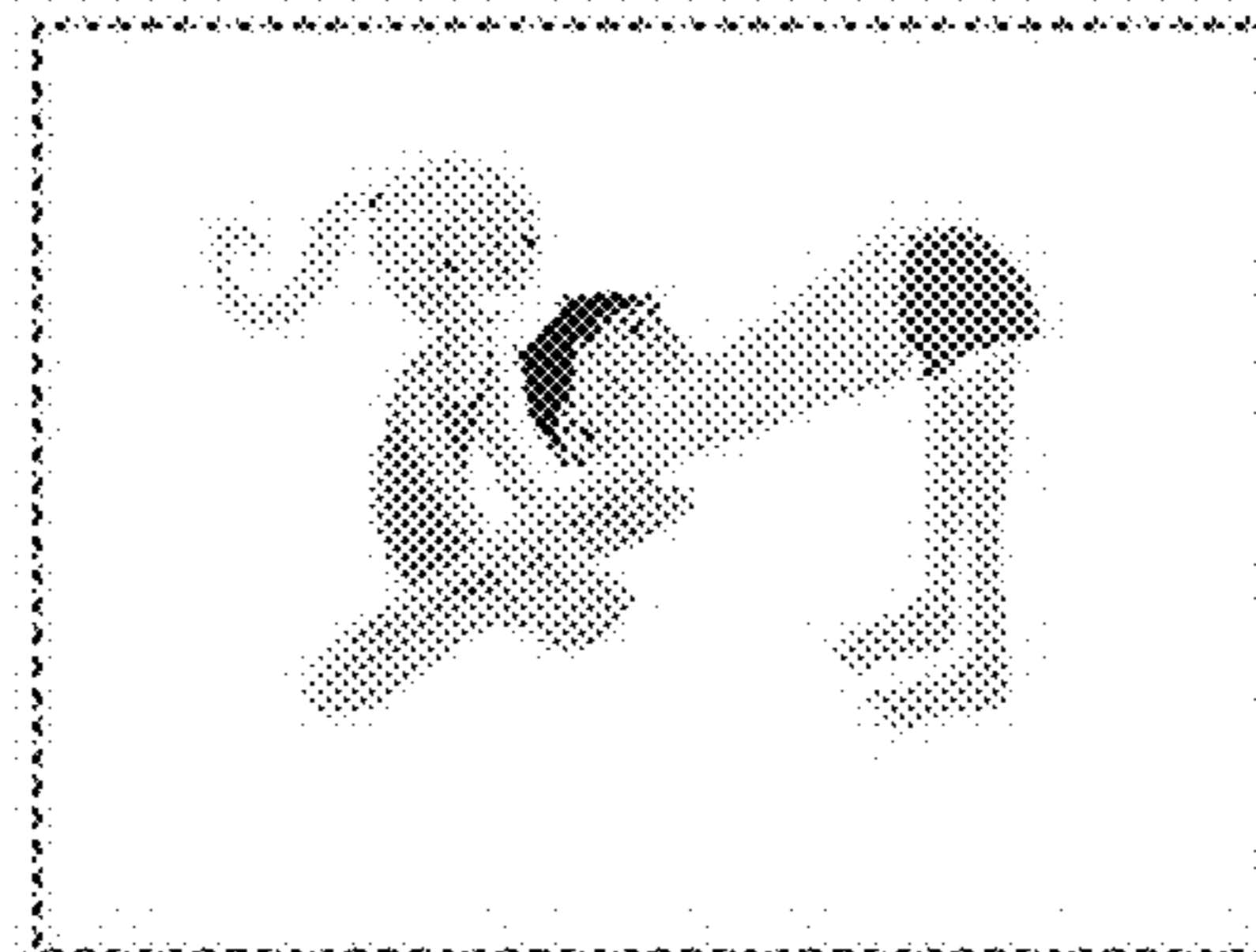

FIG. 35

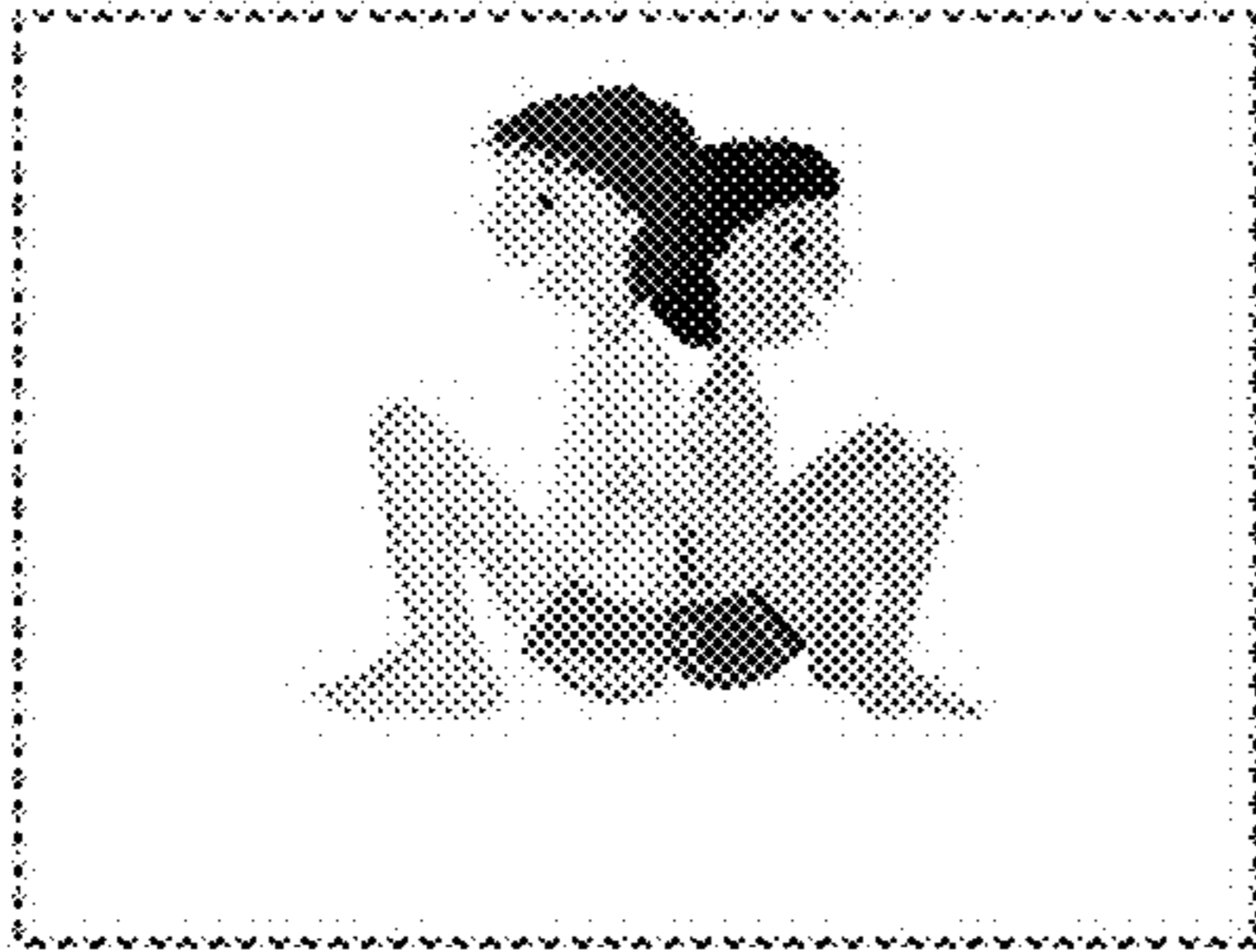

FIG. 36

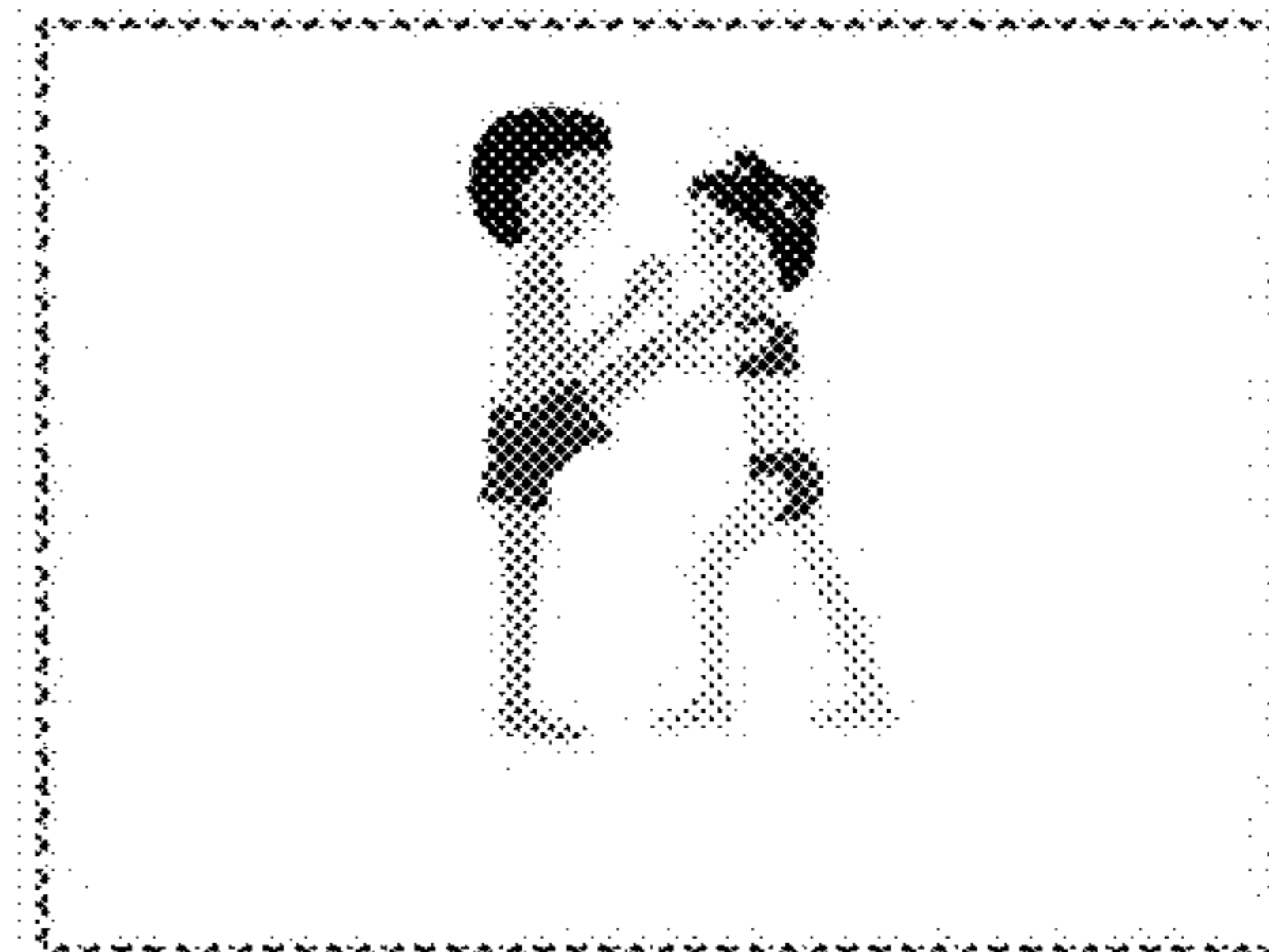

FIG. 37

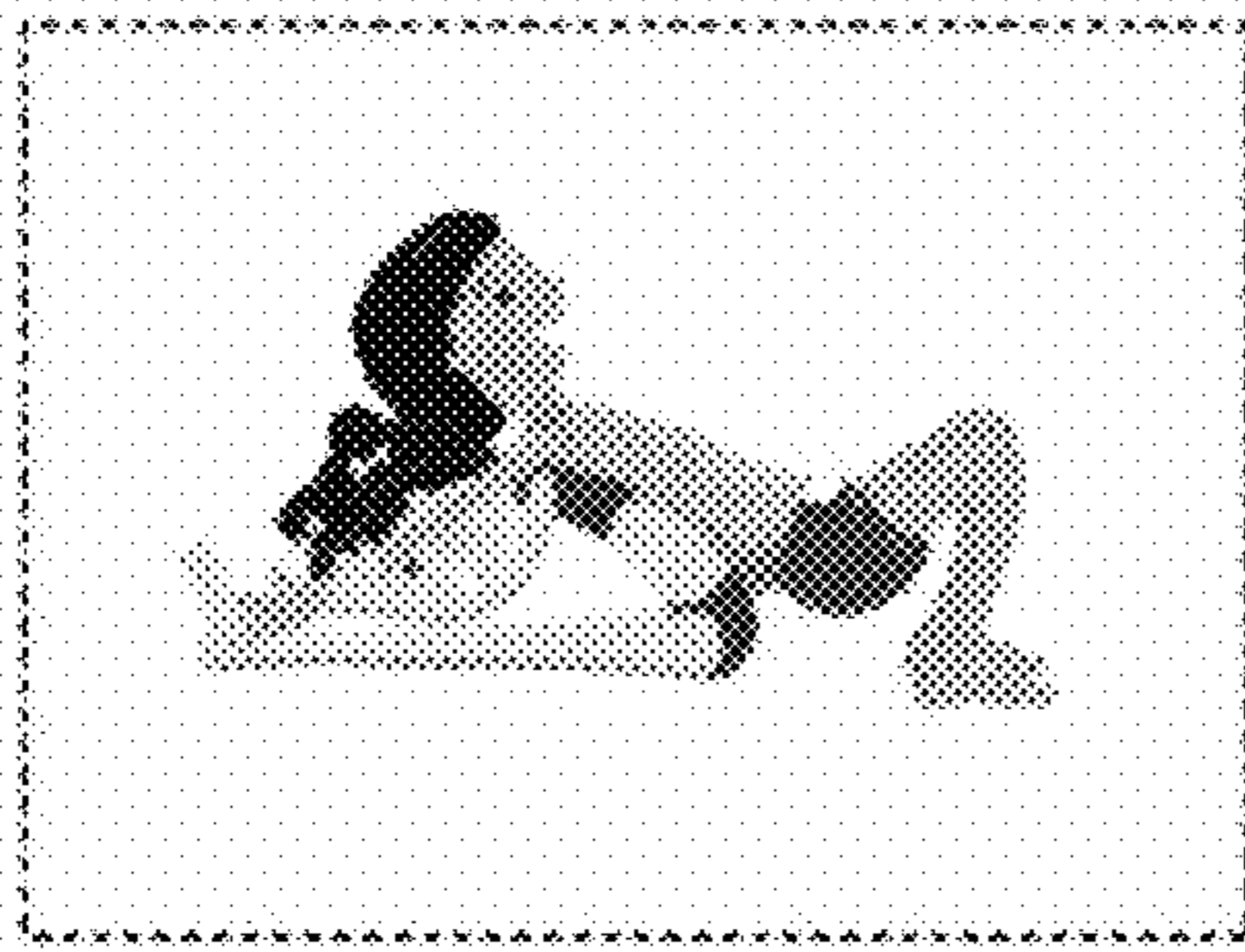

FIG. 38

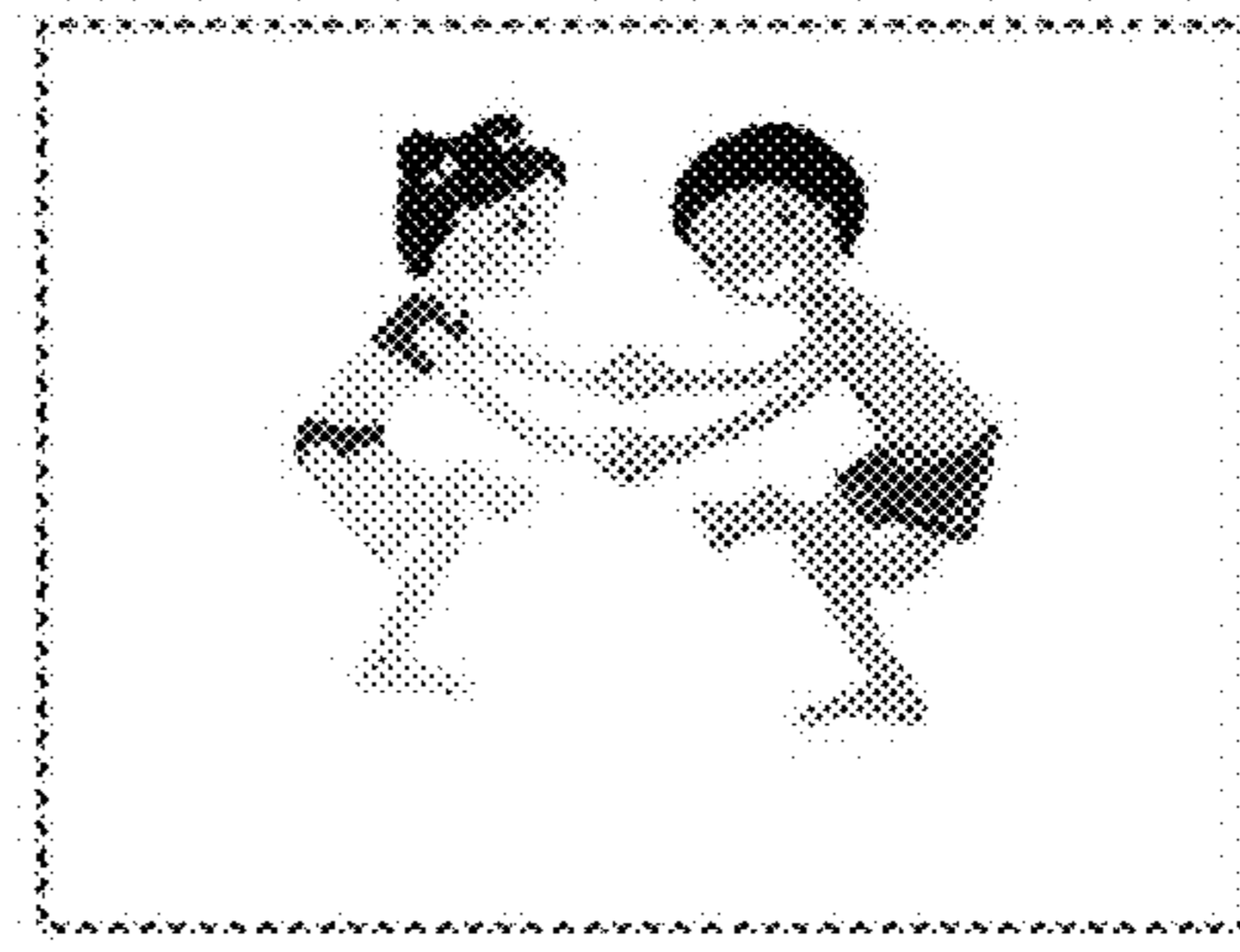

FIG. 39

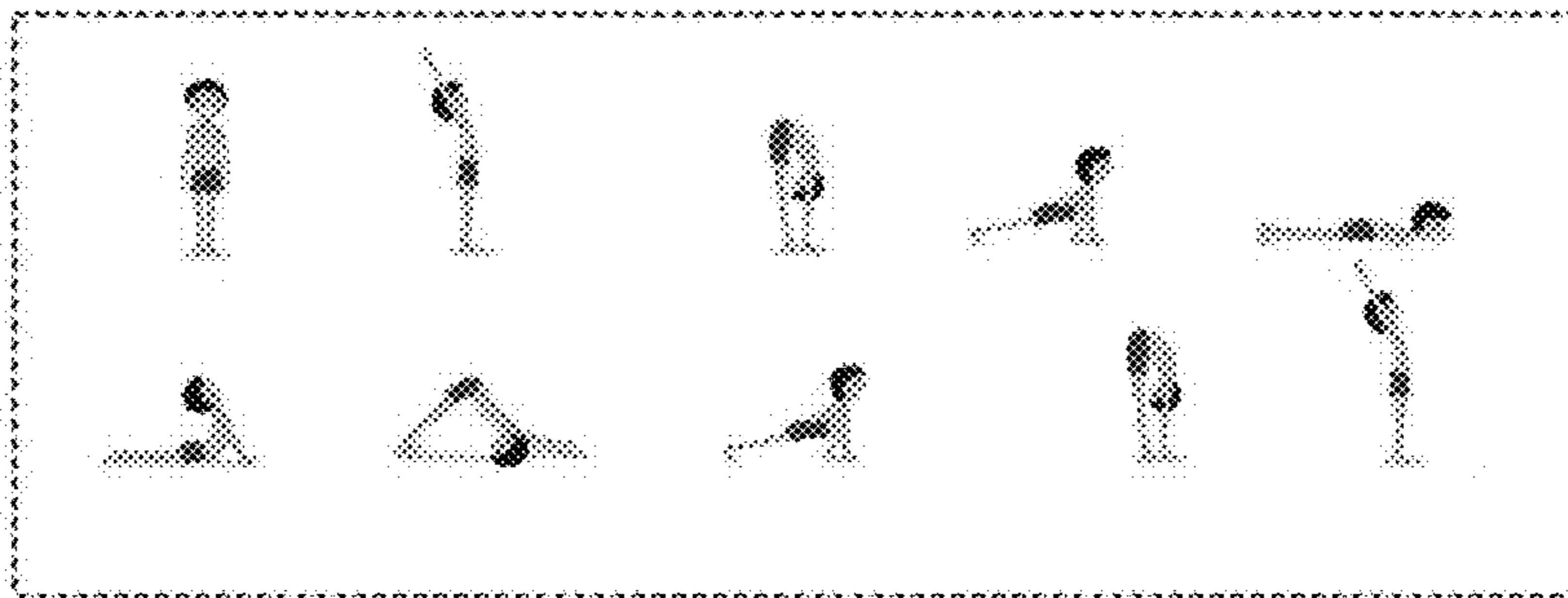

FIG. 40

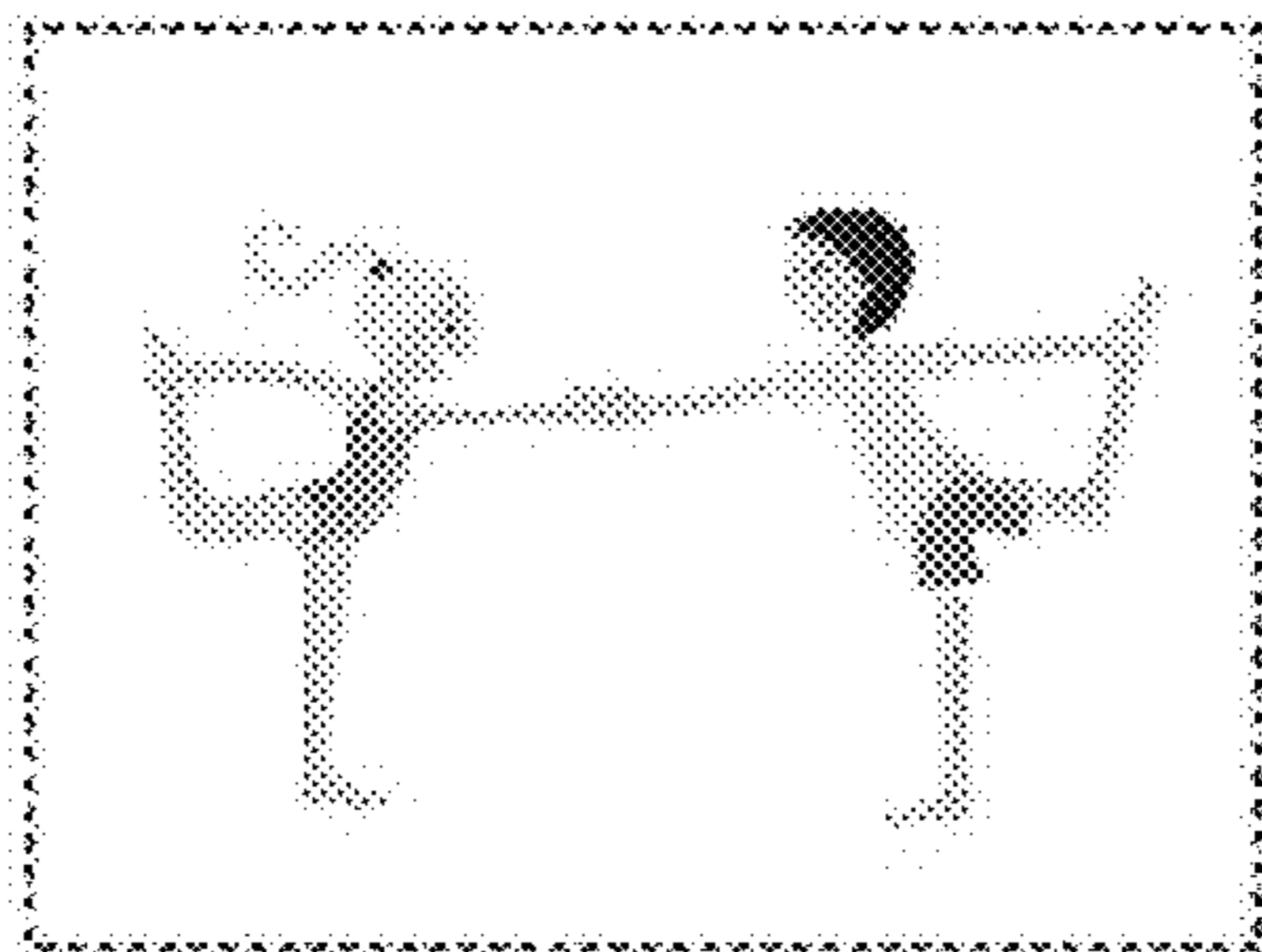

FIG. 41

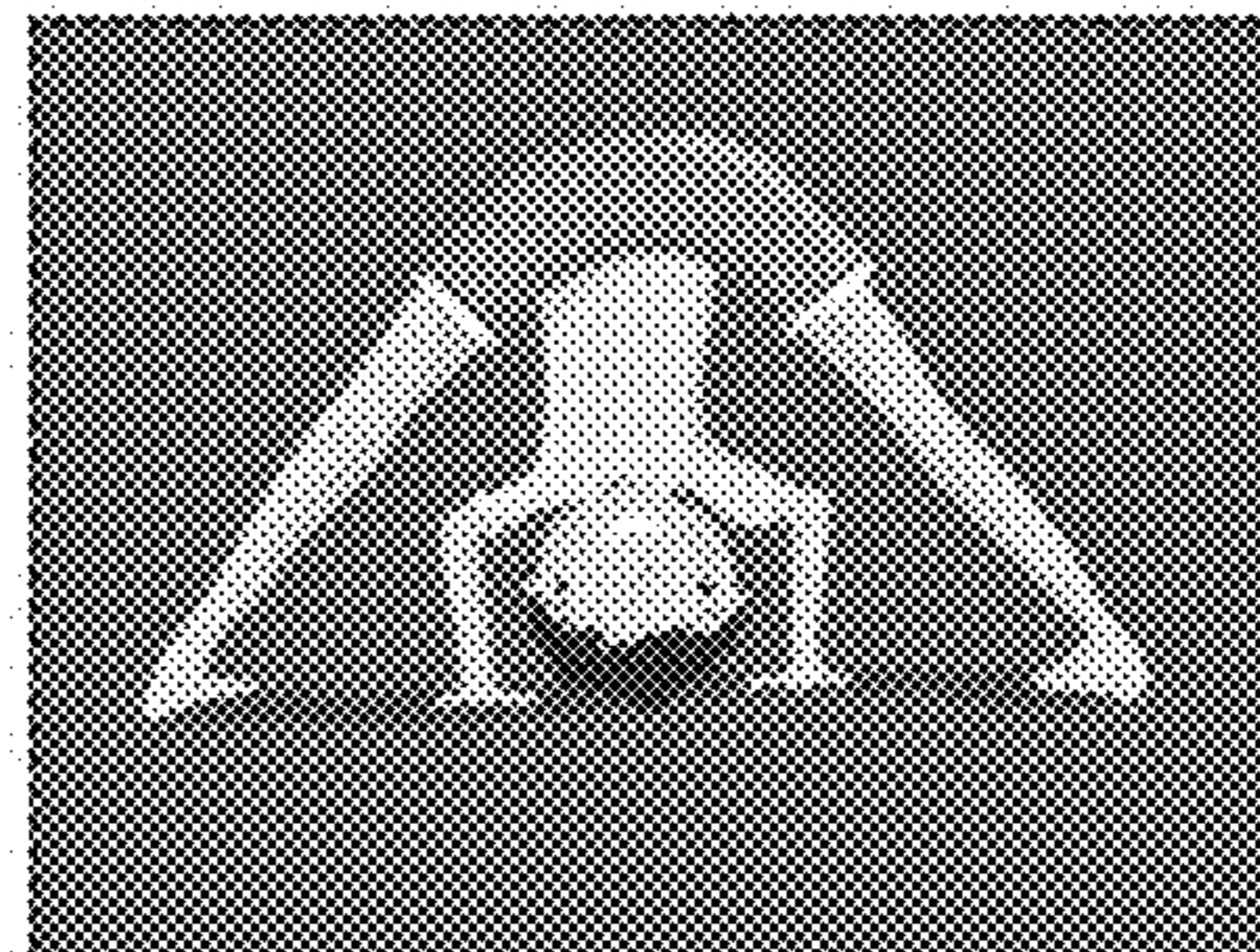

FIG. 42

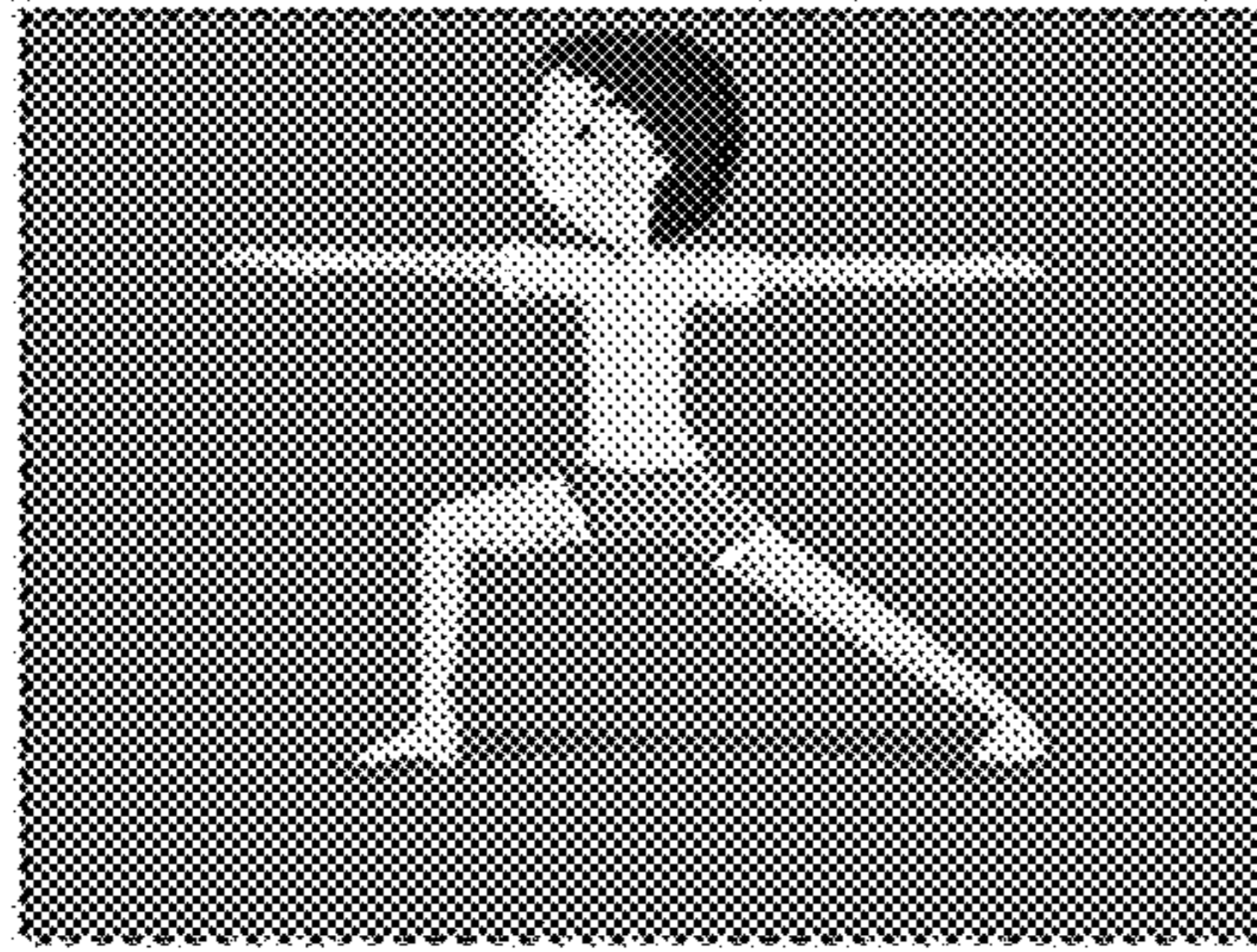

FIG. 43

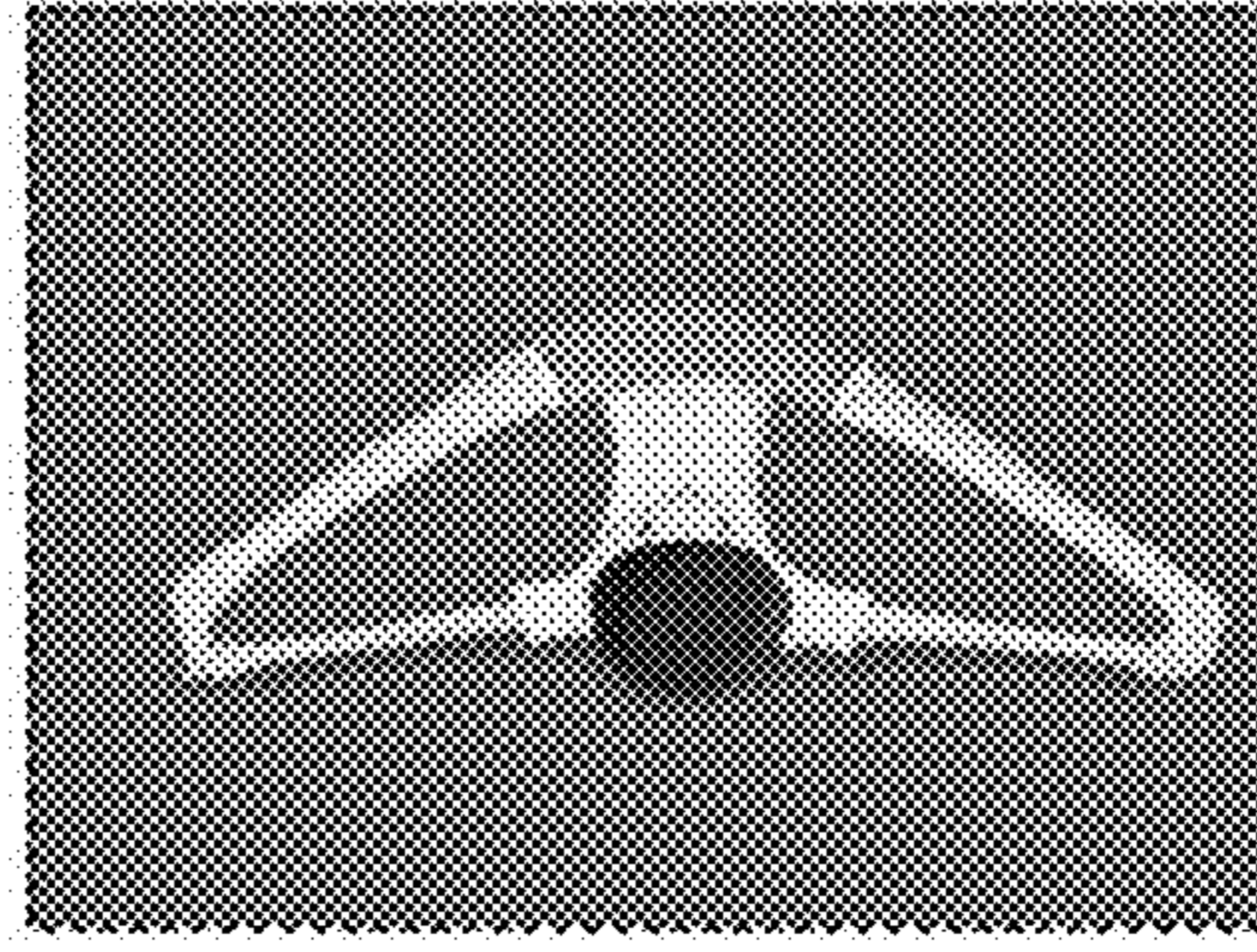

FIG. 44

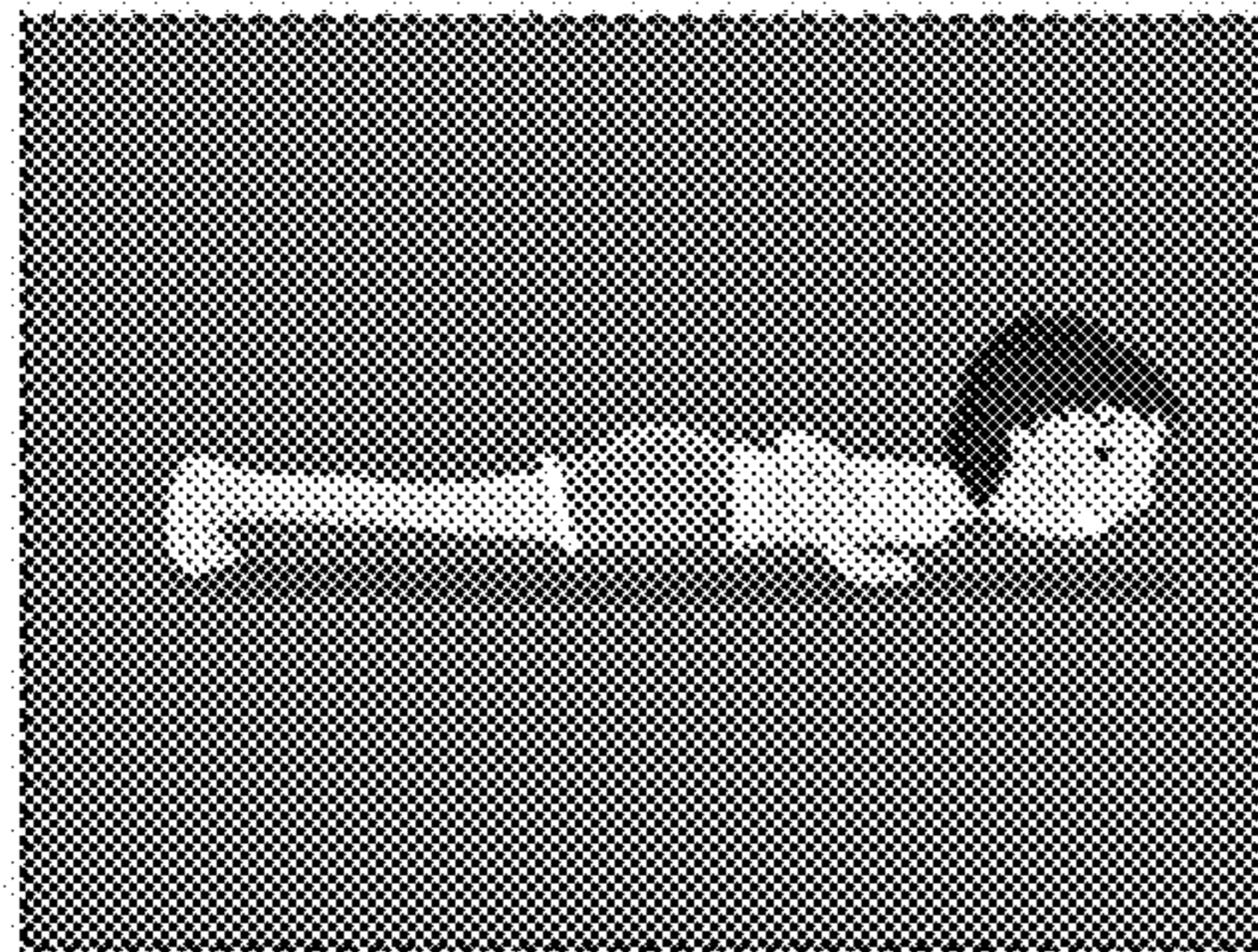

FIG. 45

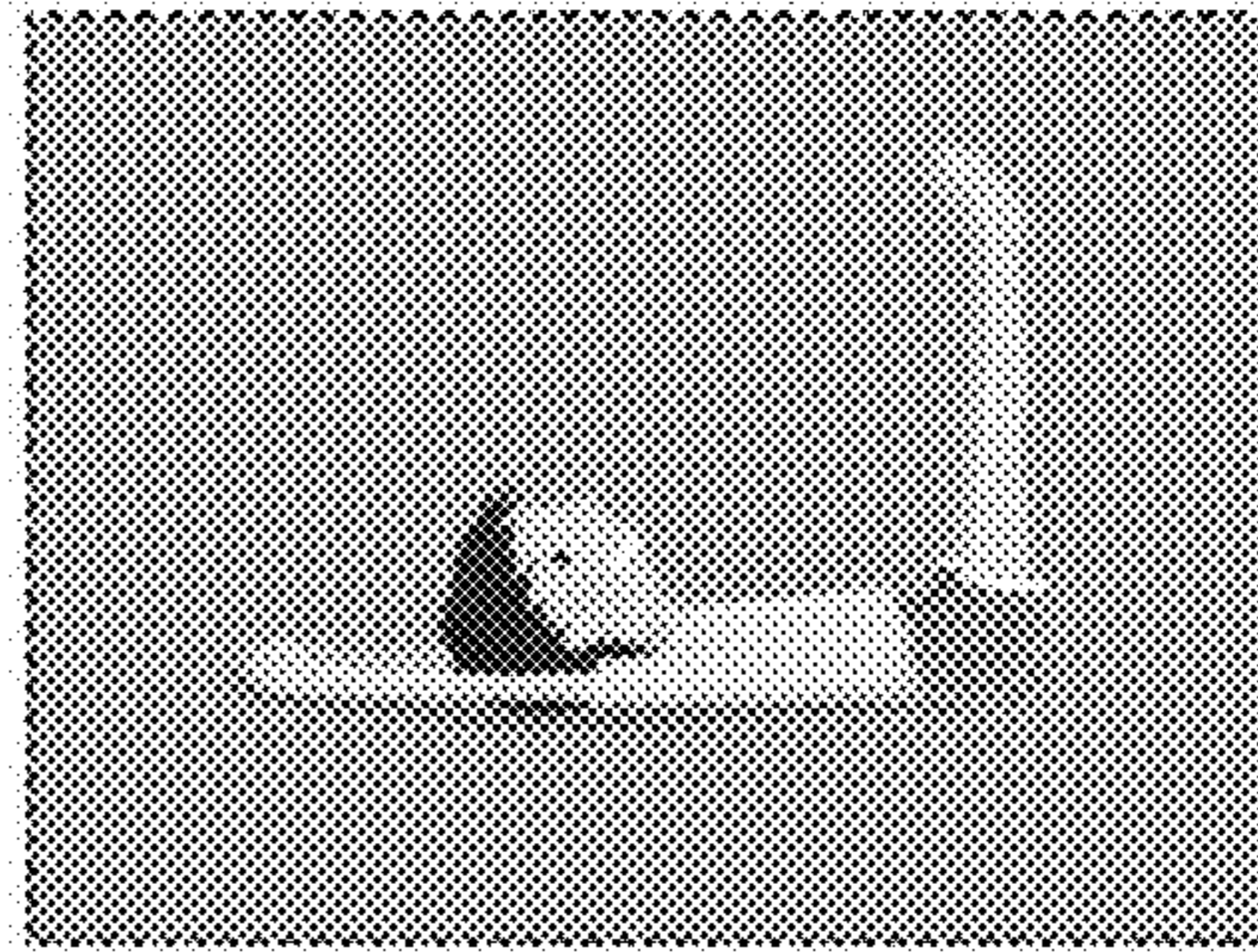

FIG. 46

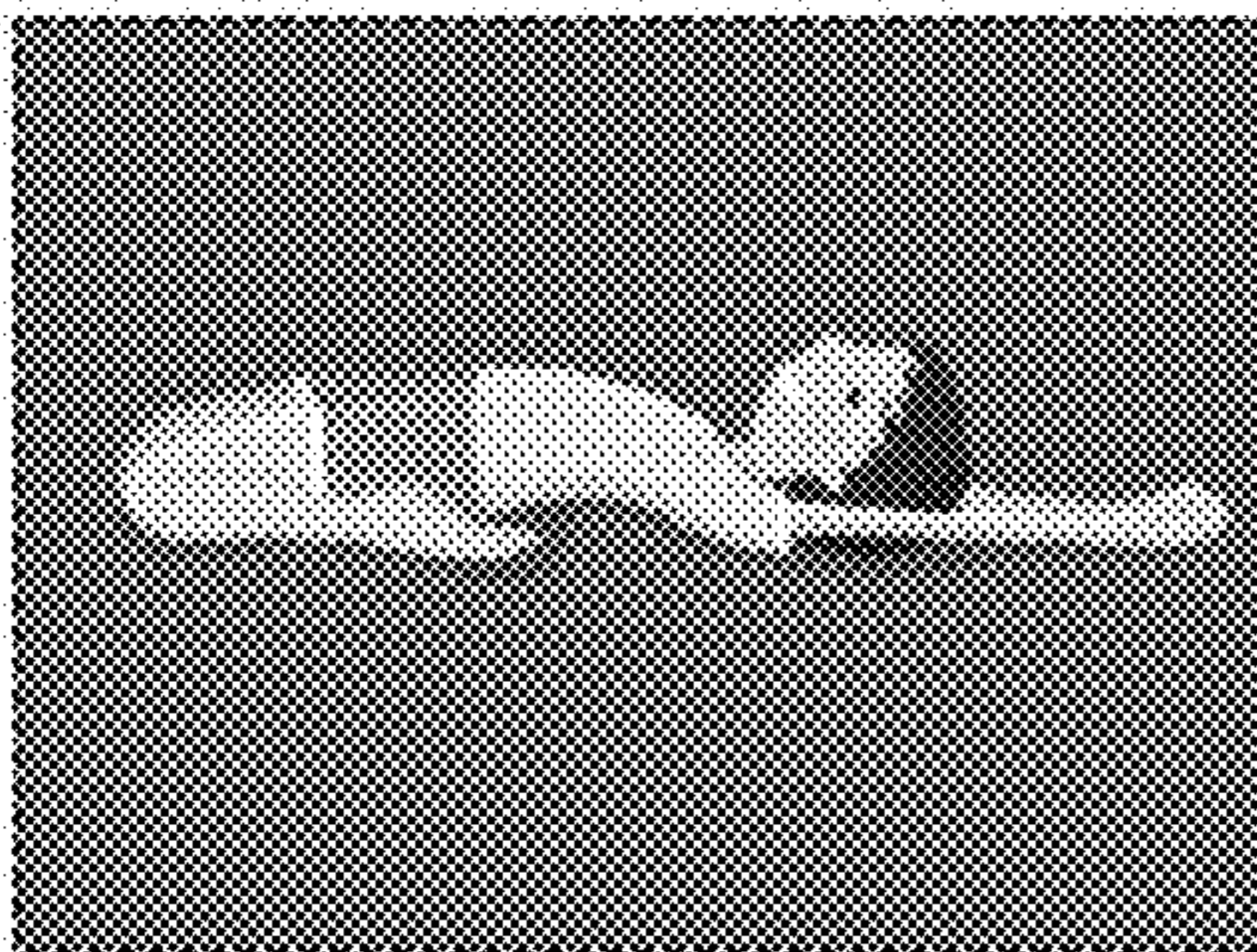

FIG. 47

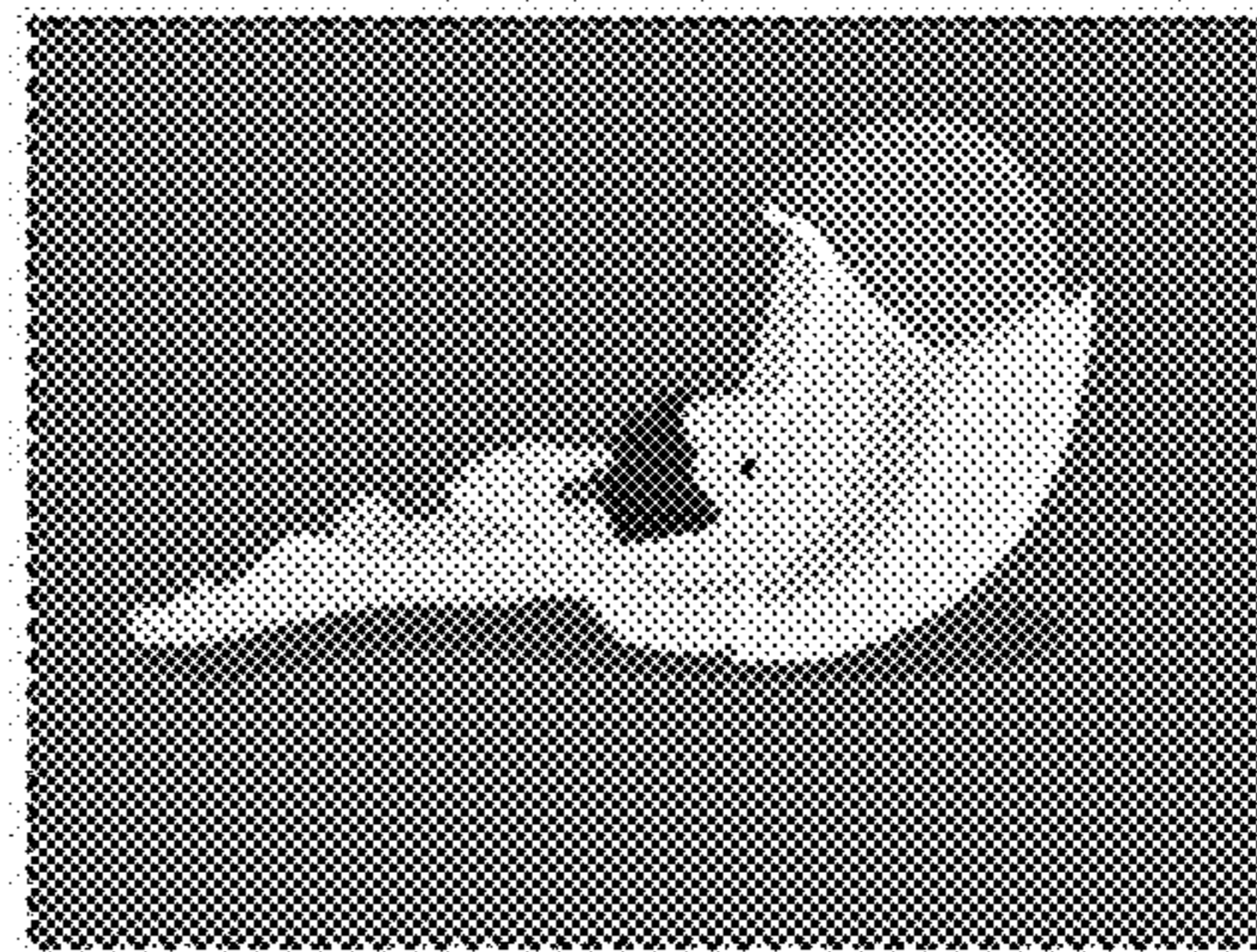

FIG. 48

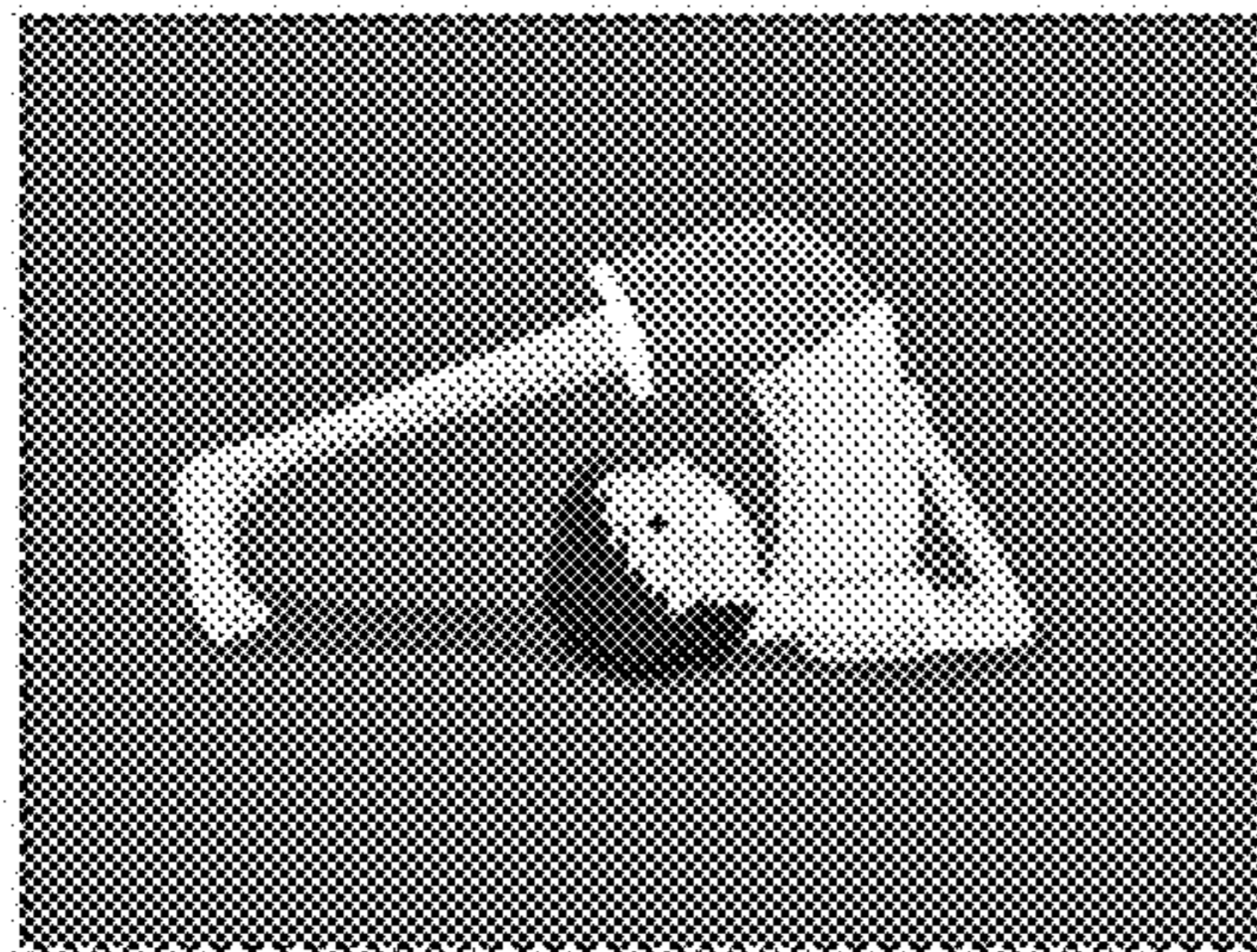

FIG. 49

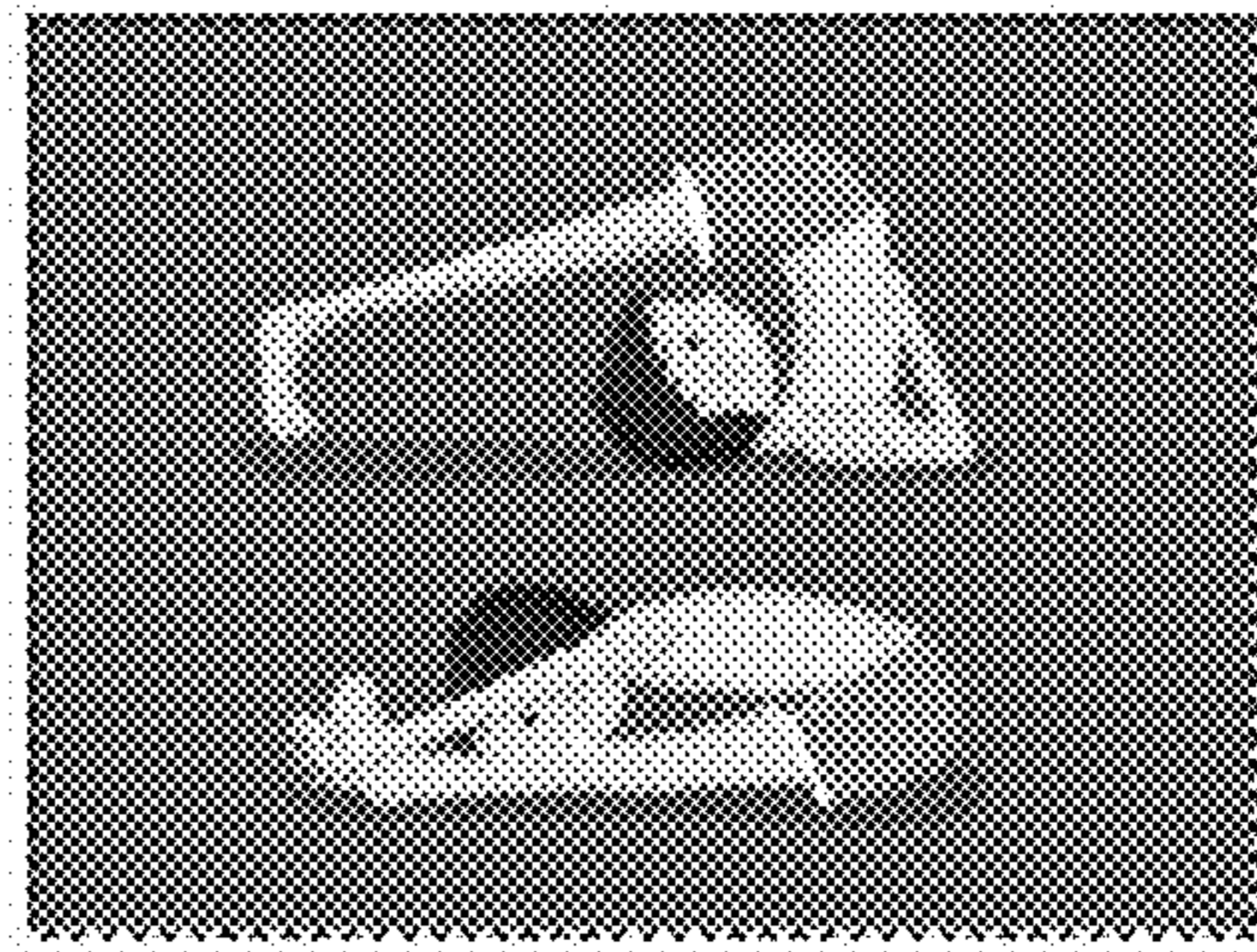

FIG. 50

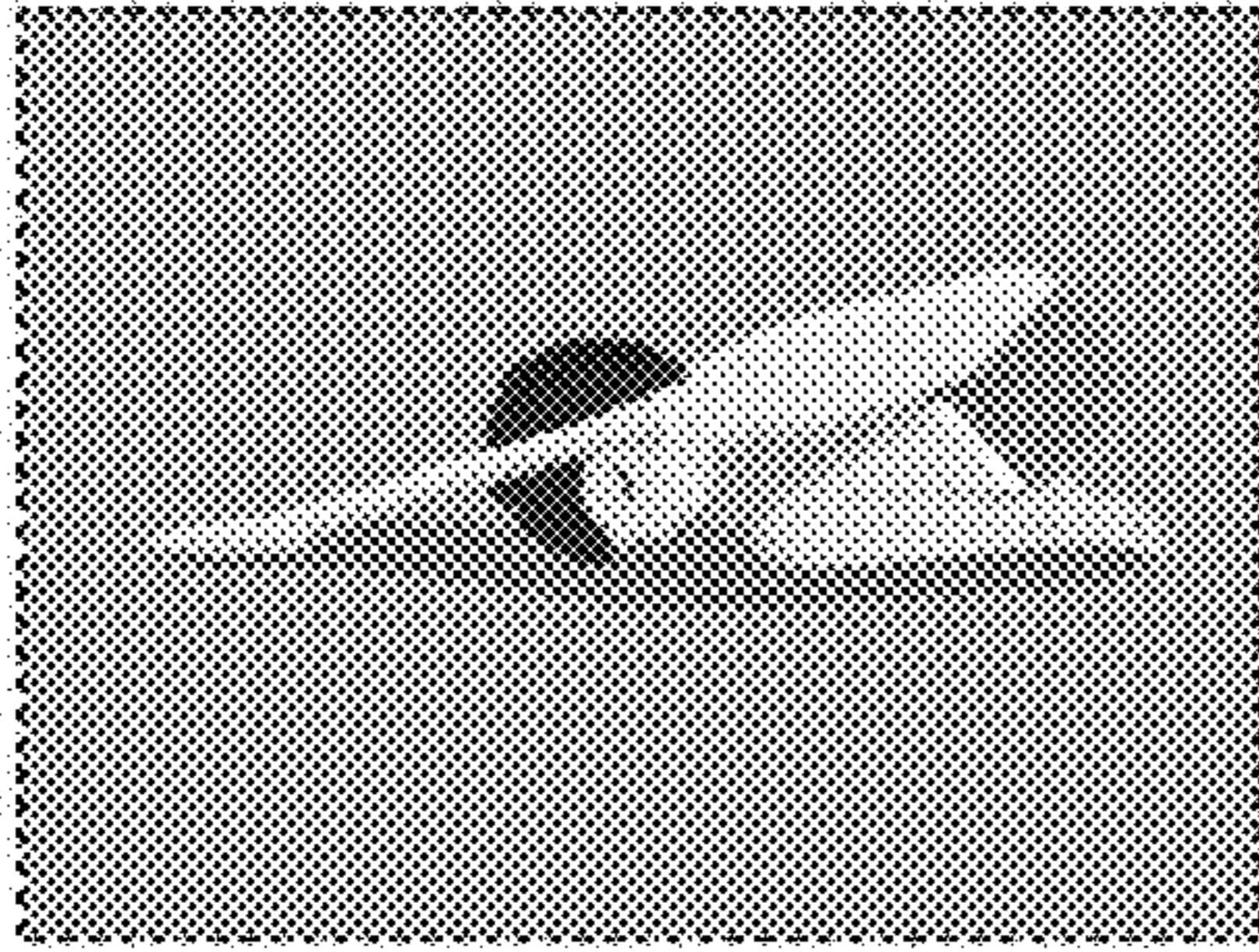

FIG. 51

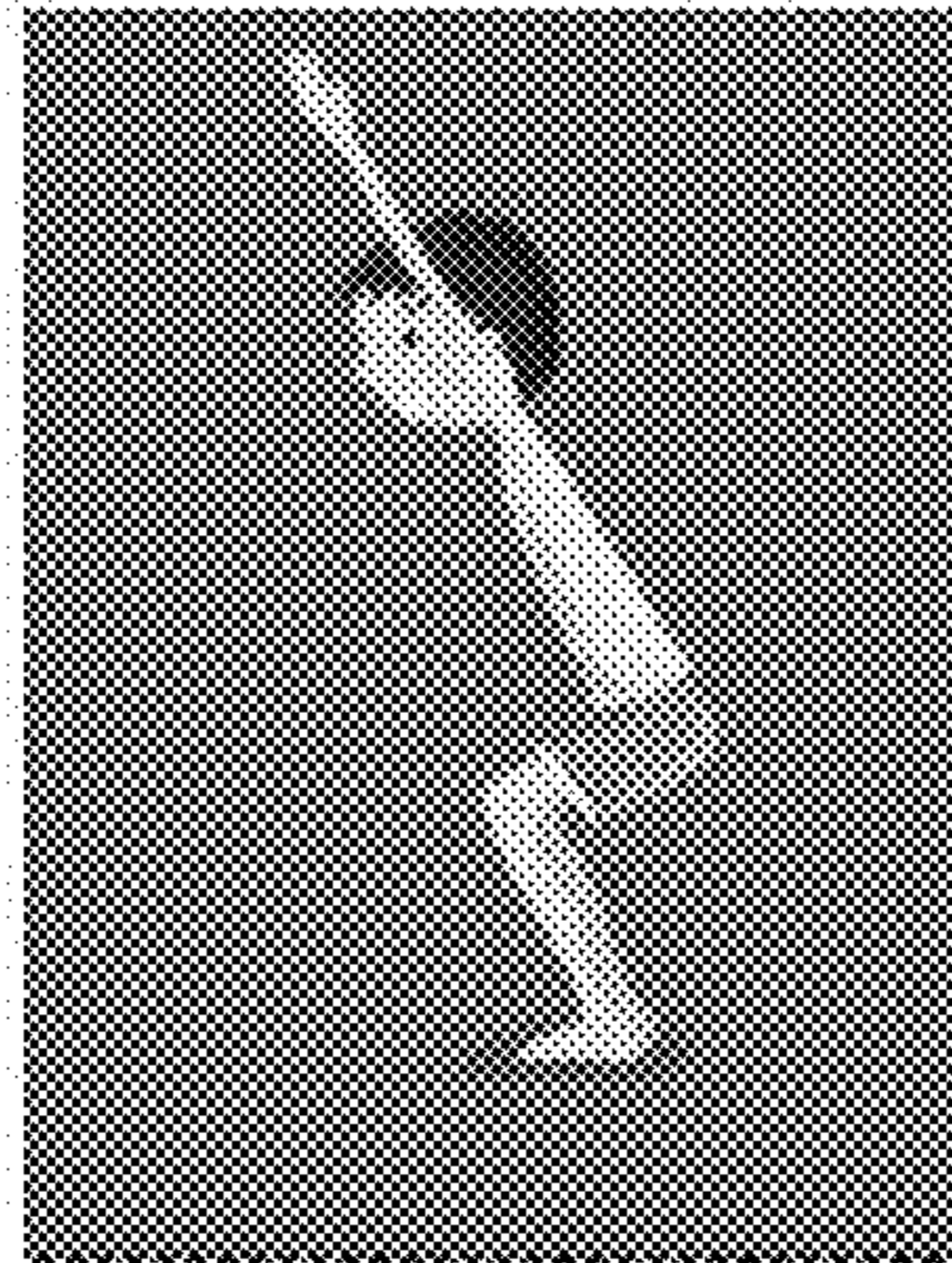

FIG. 52

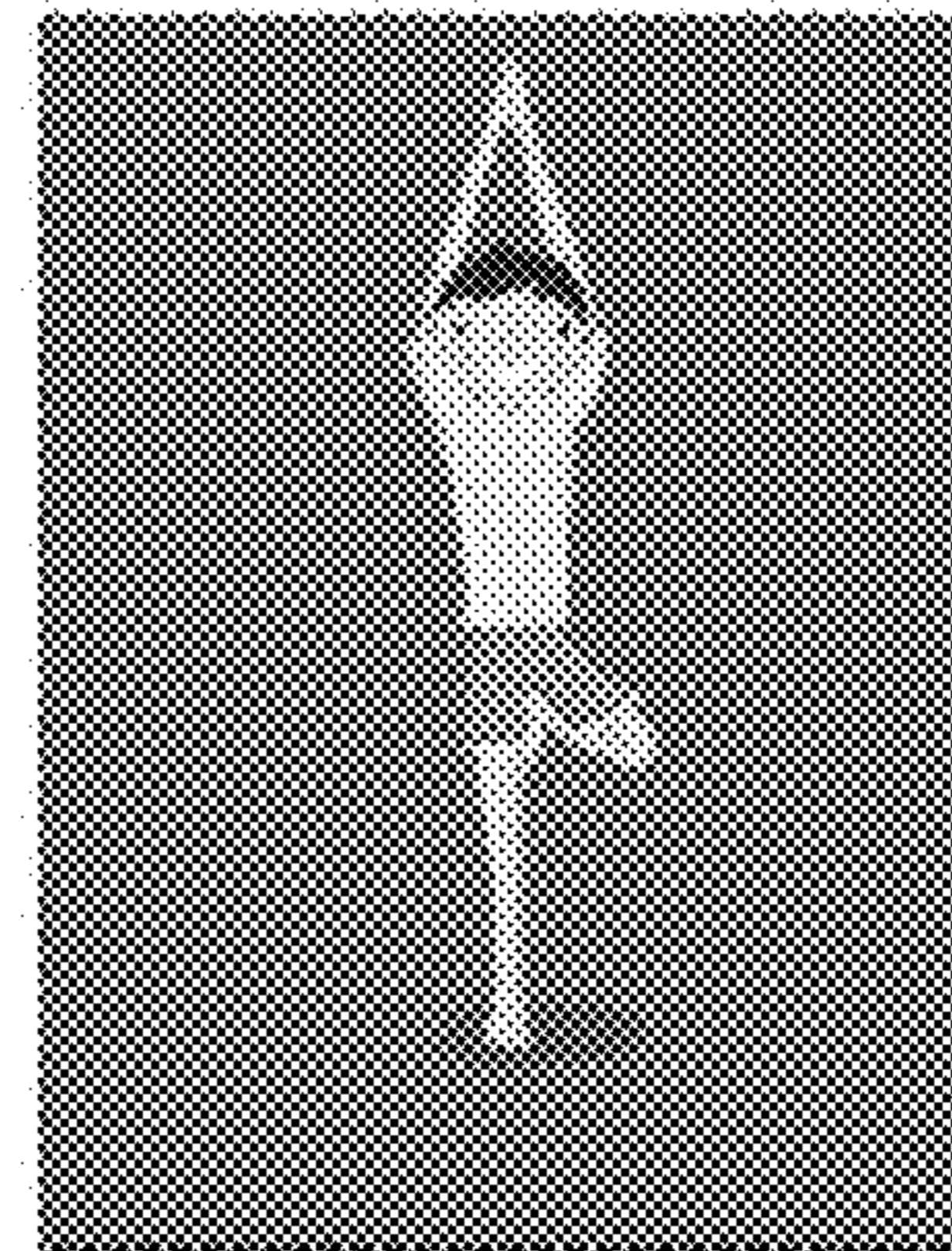

FIG. 53

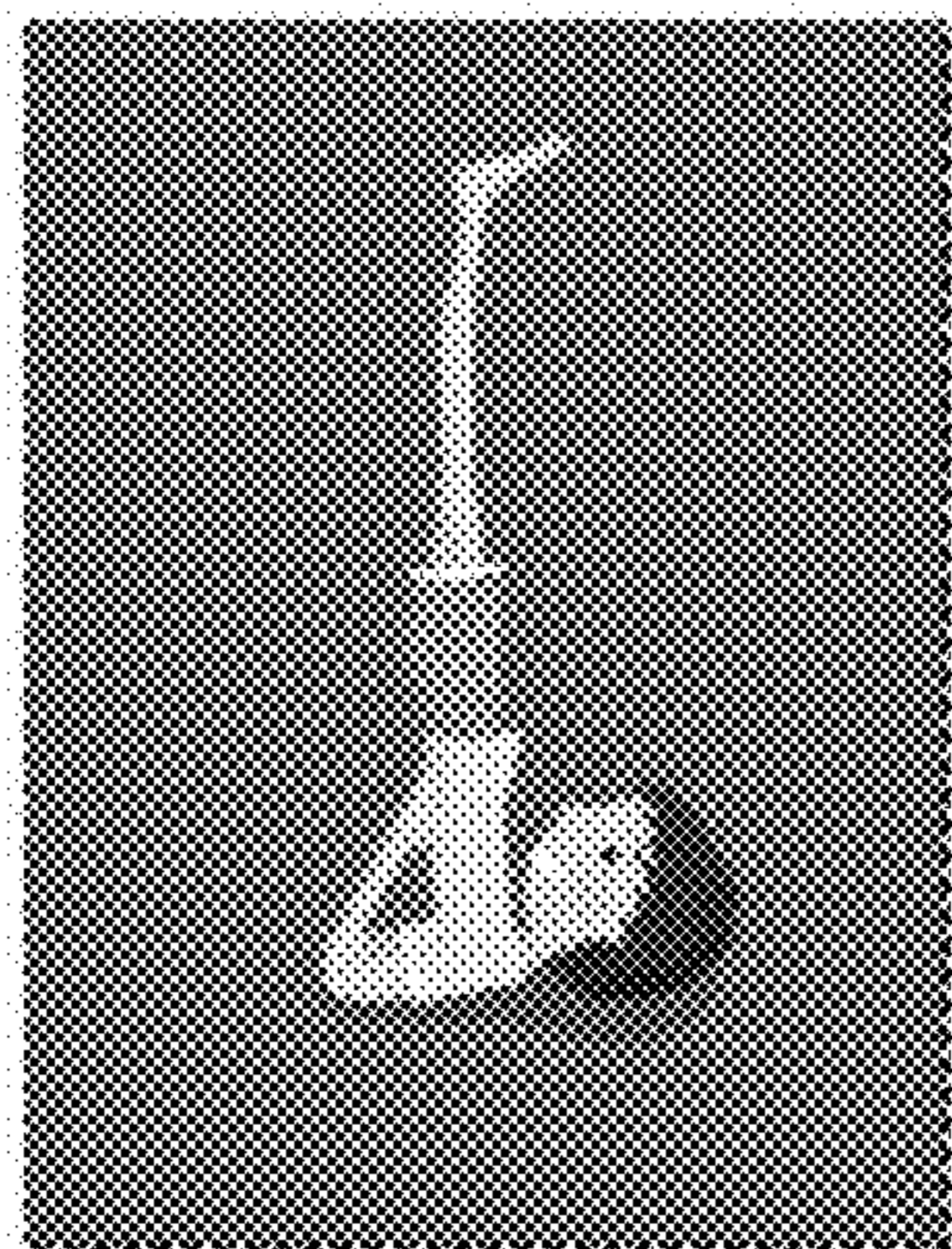

FIG. 54

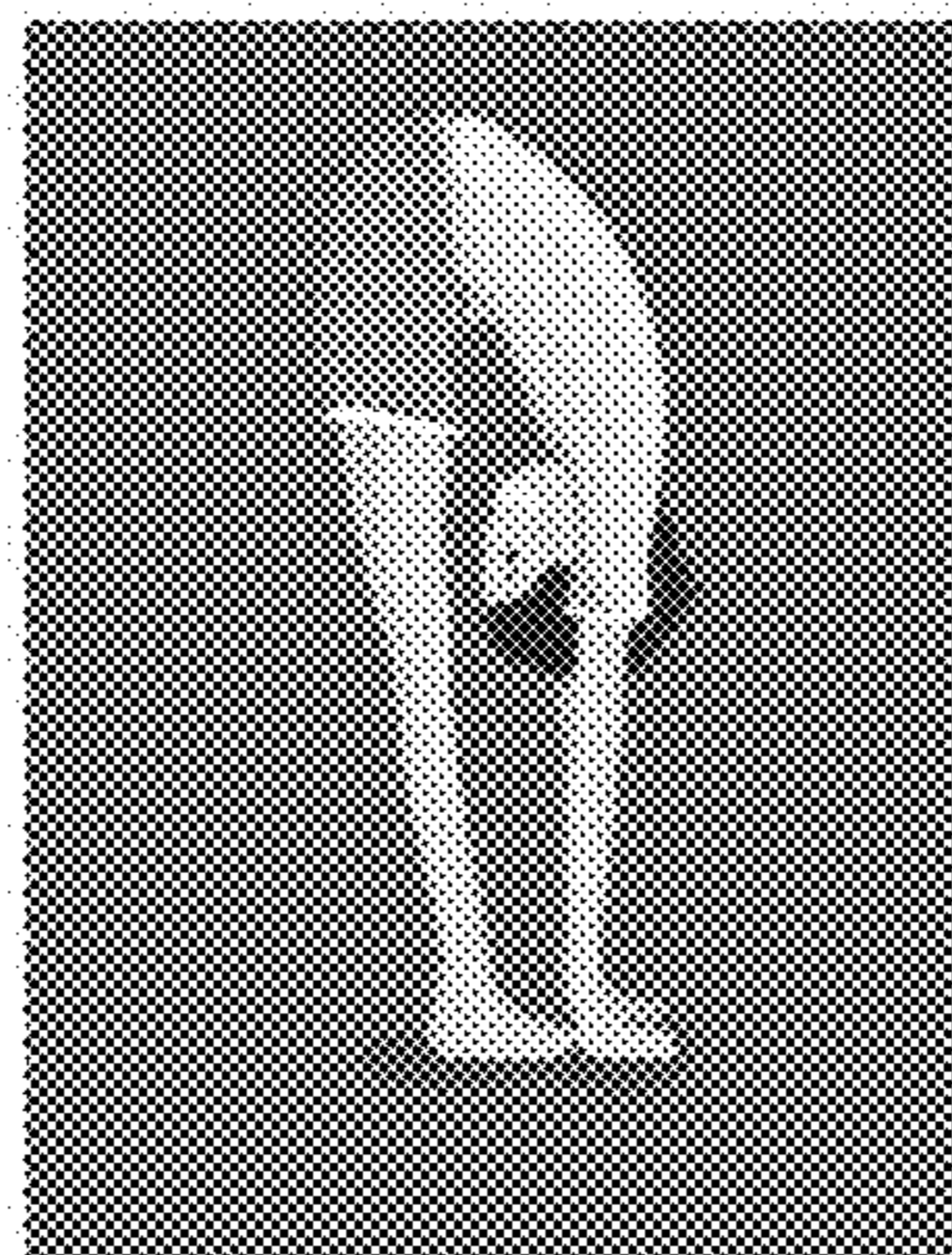

FIG. 55

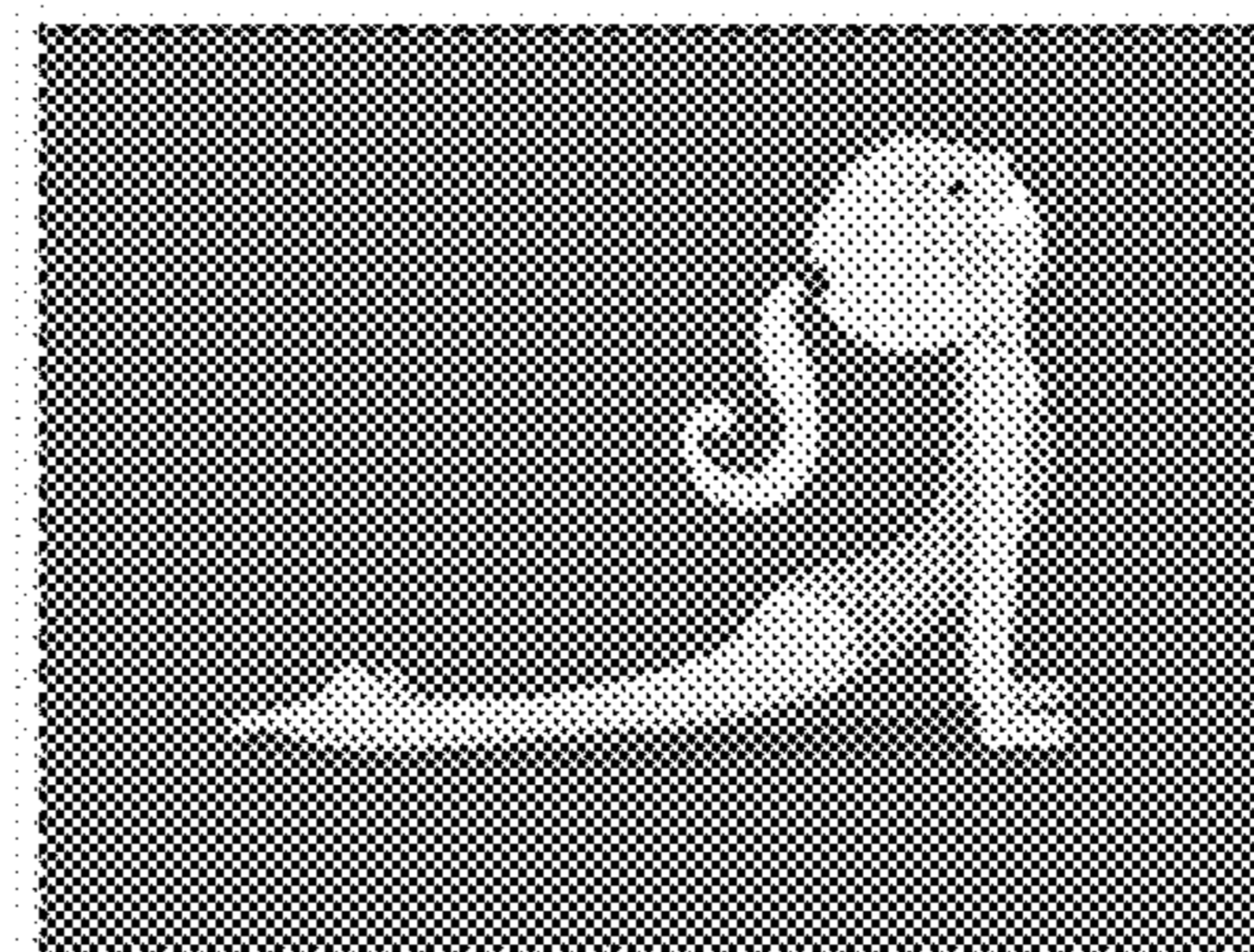

FIG. 56

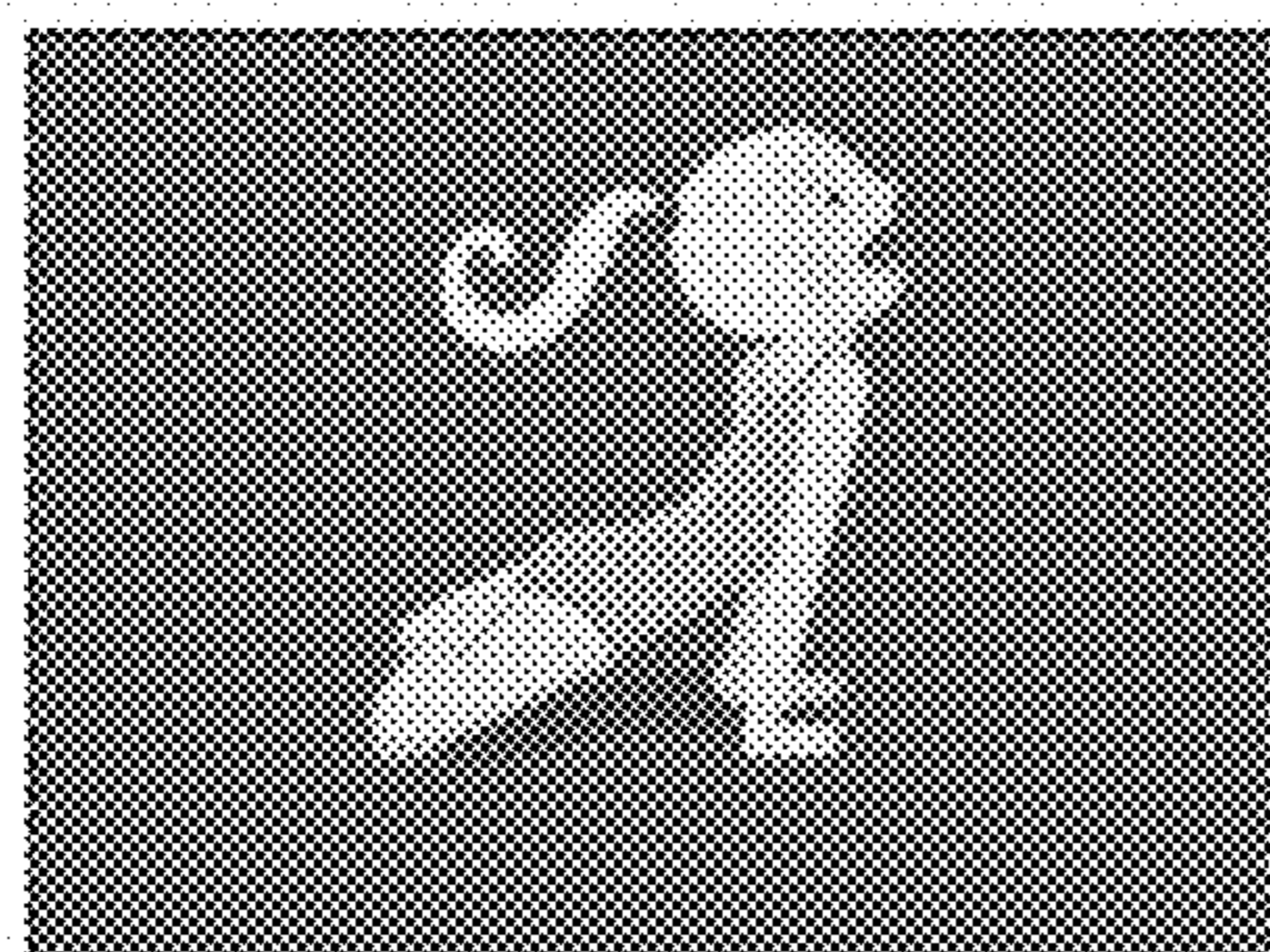

FIG. 57

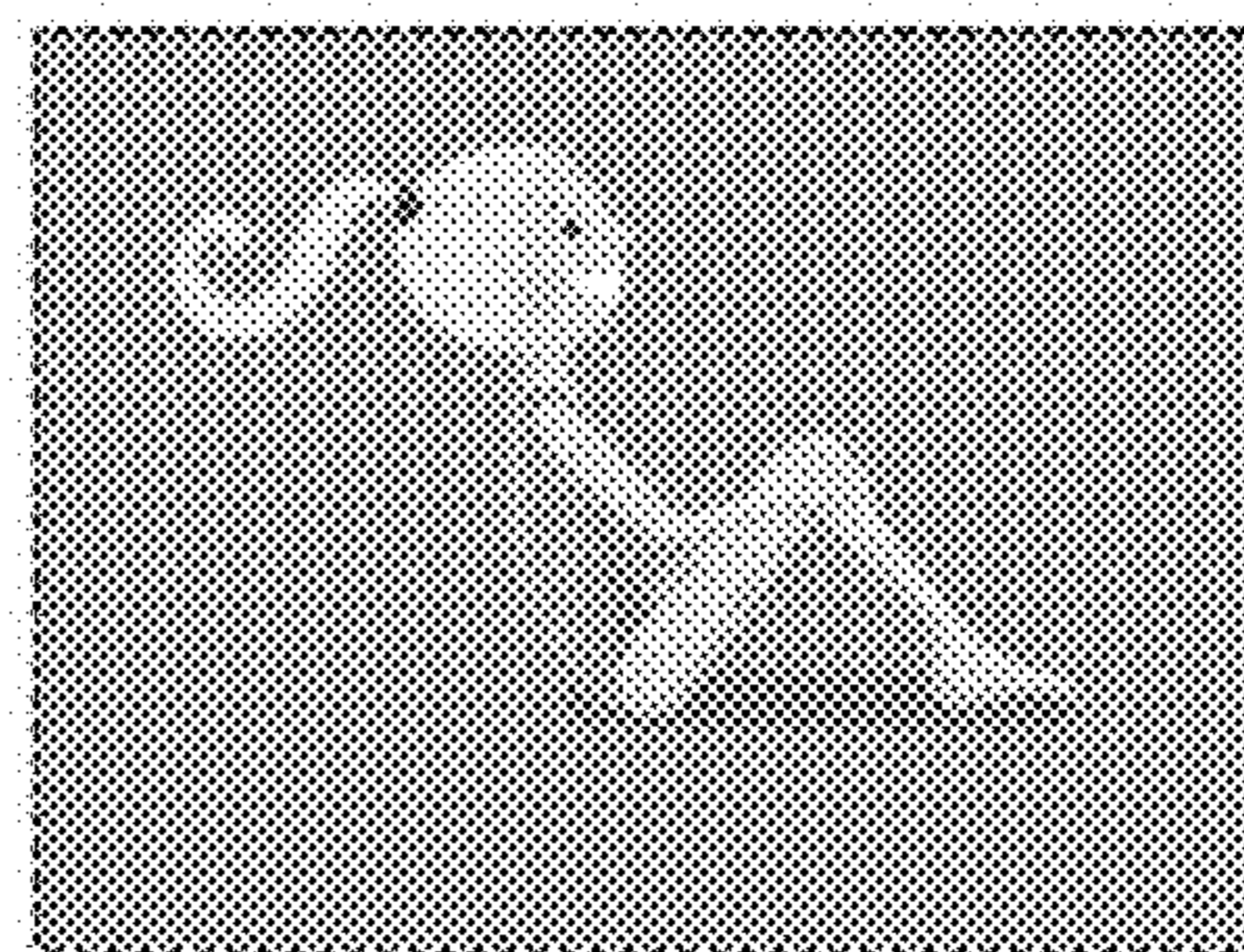

FIG. 58

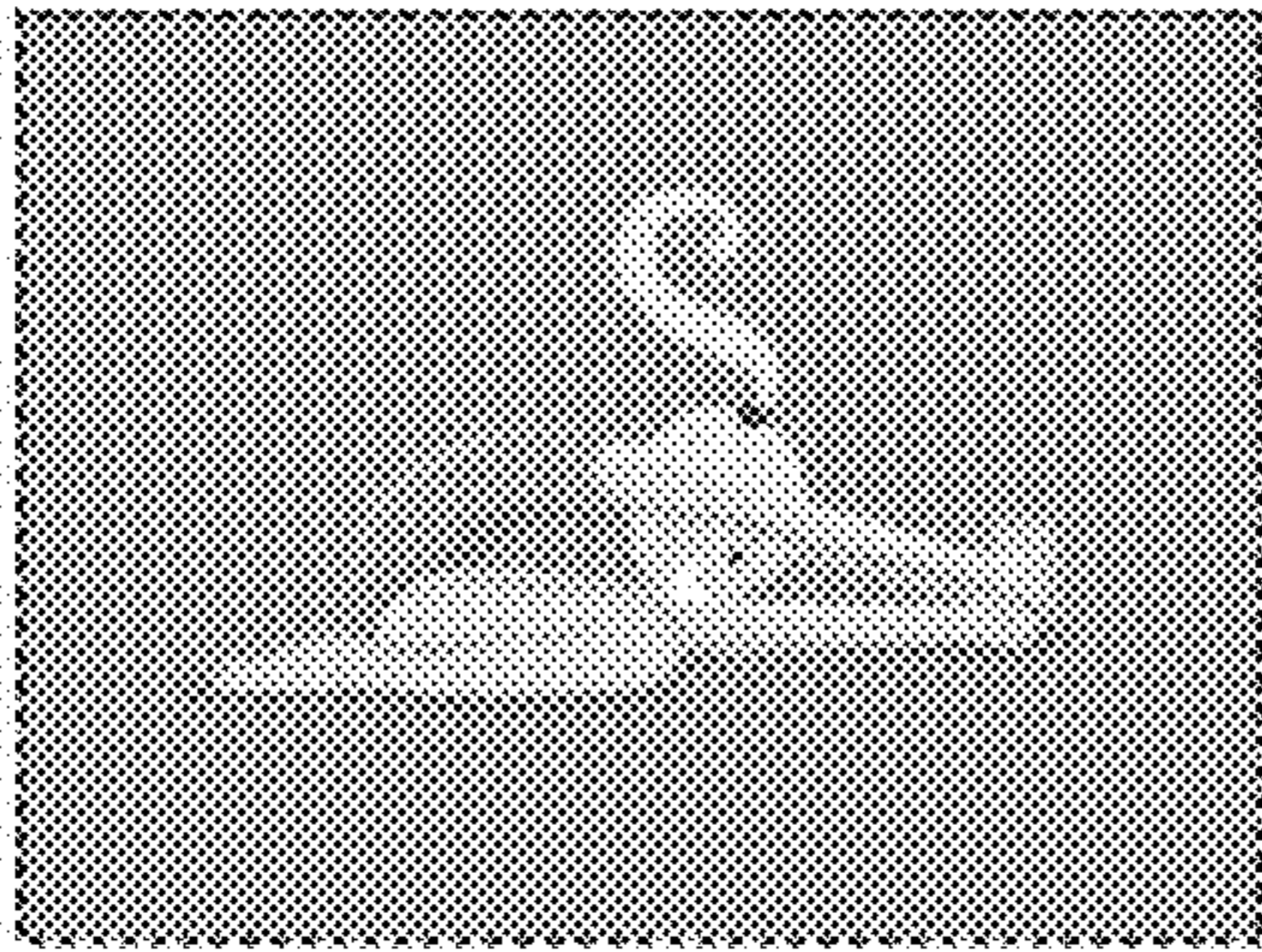

FIG. 59

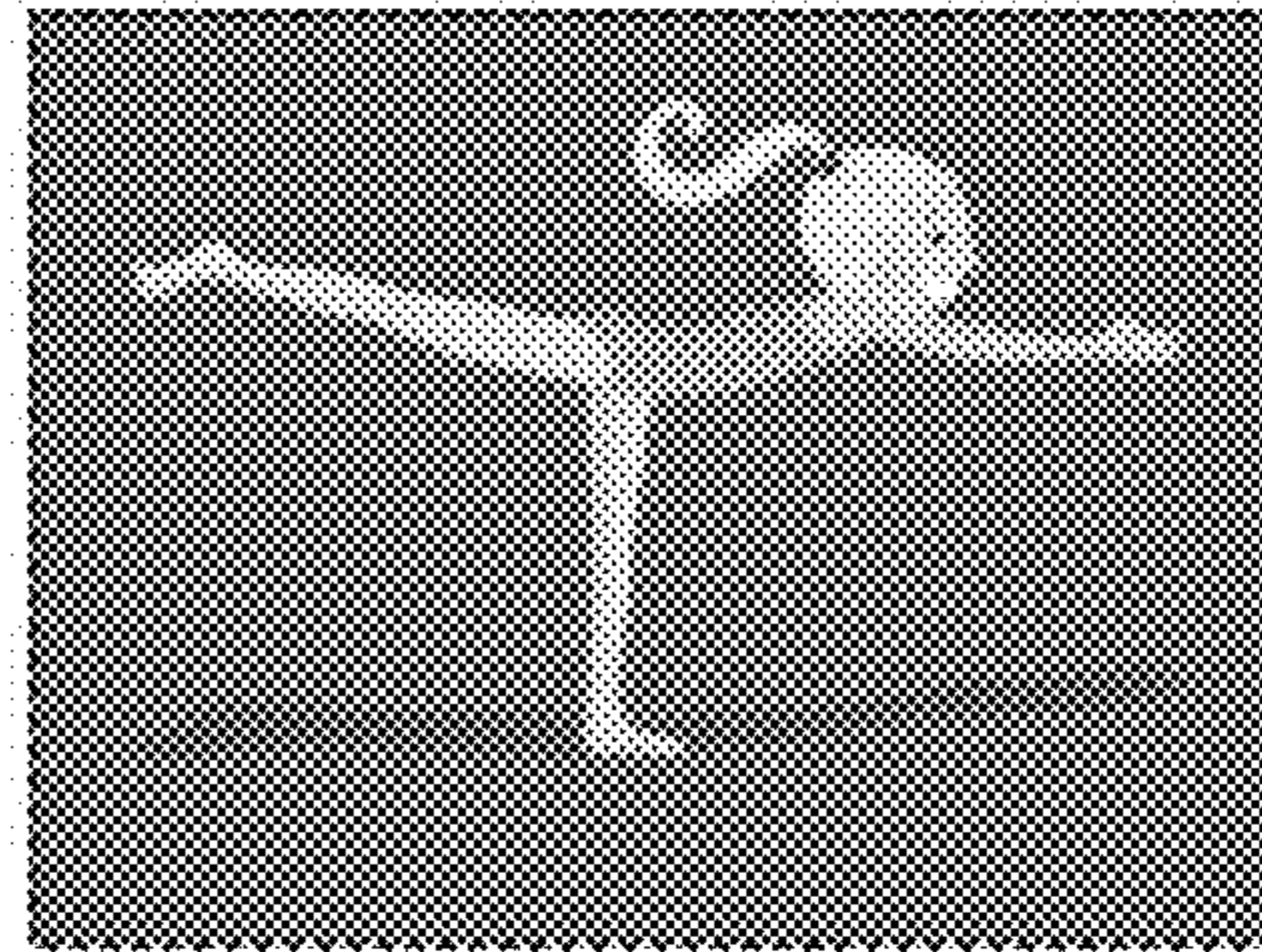

FIG. 60

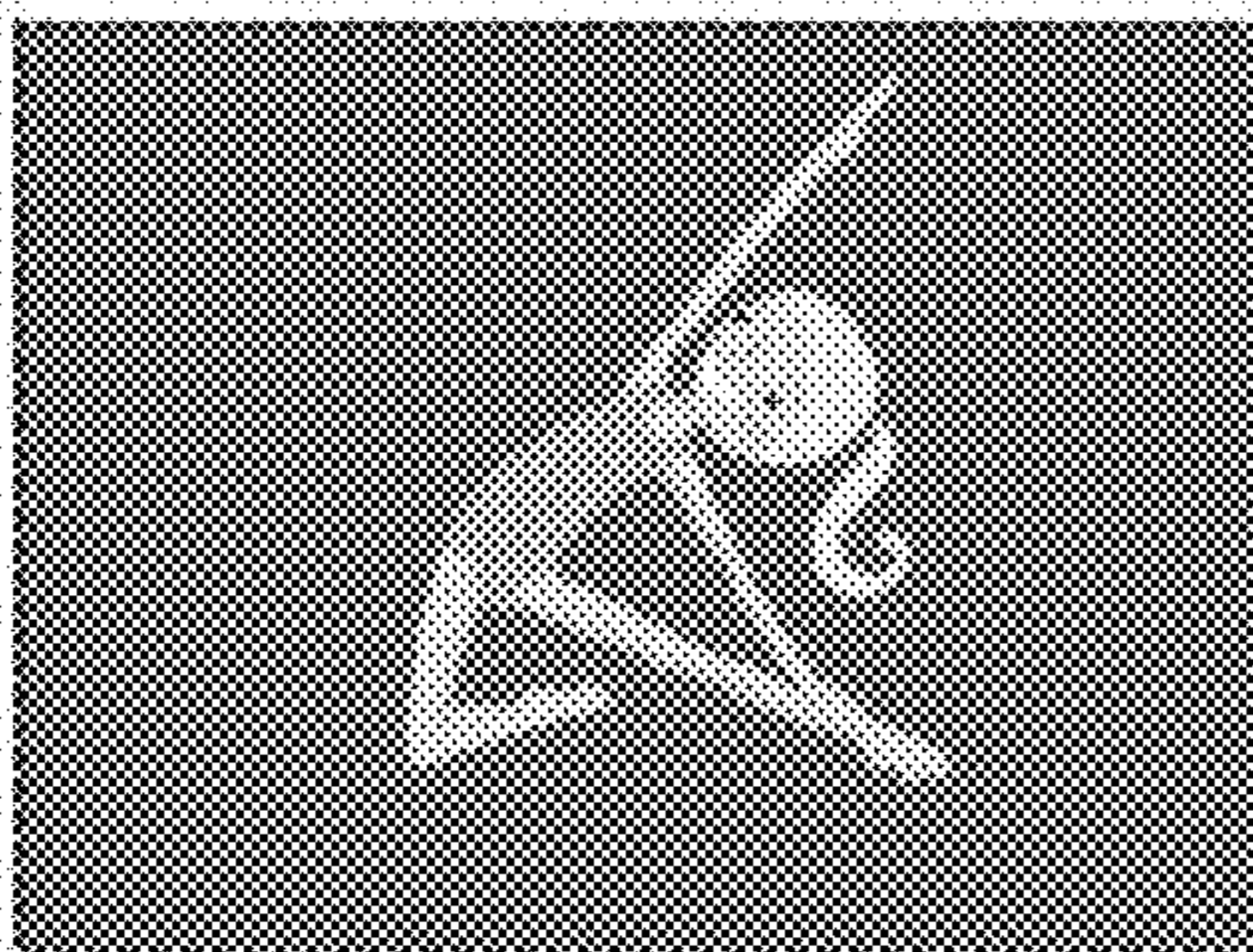

FIG. 61

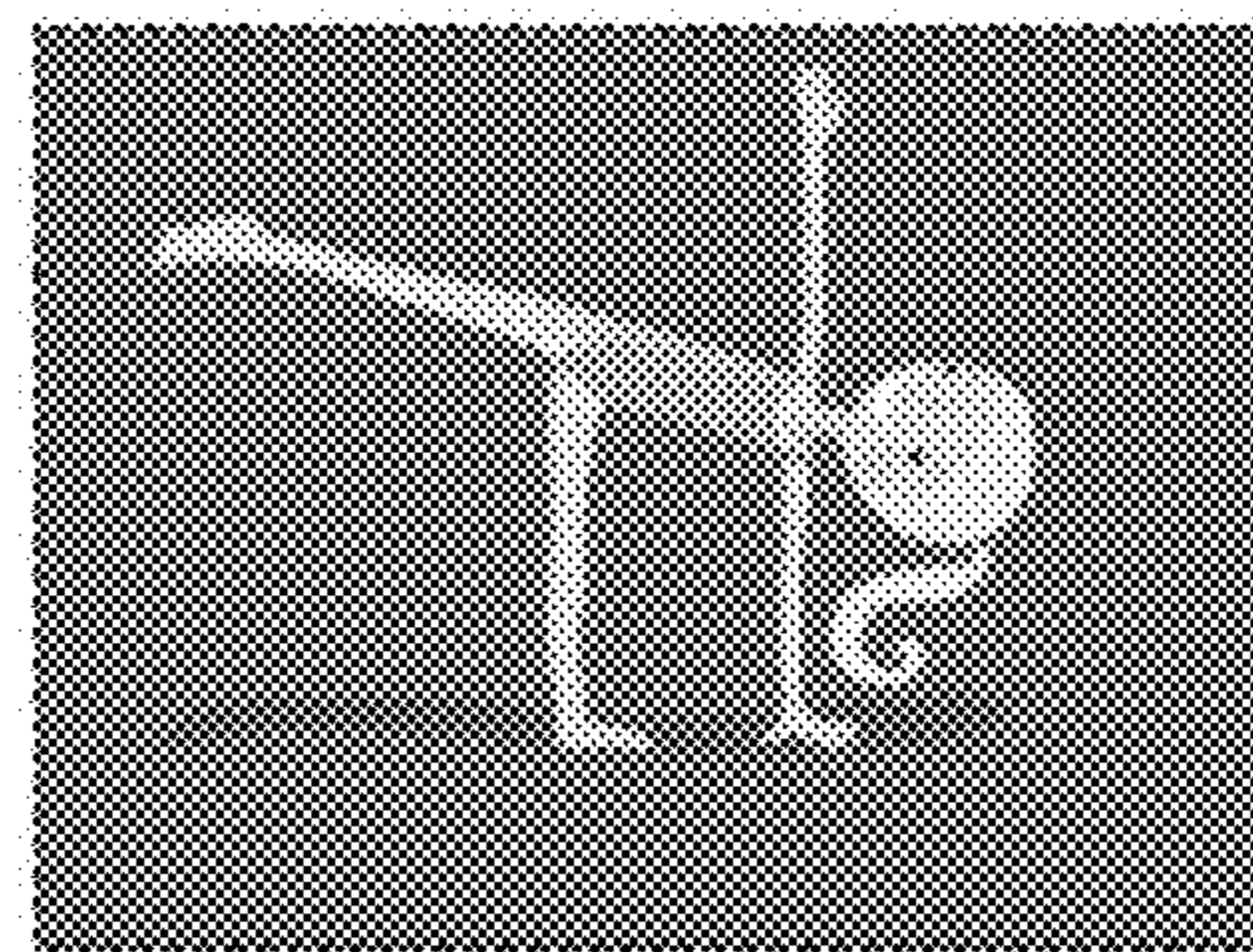

FIG. 62

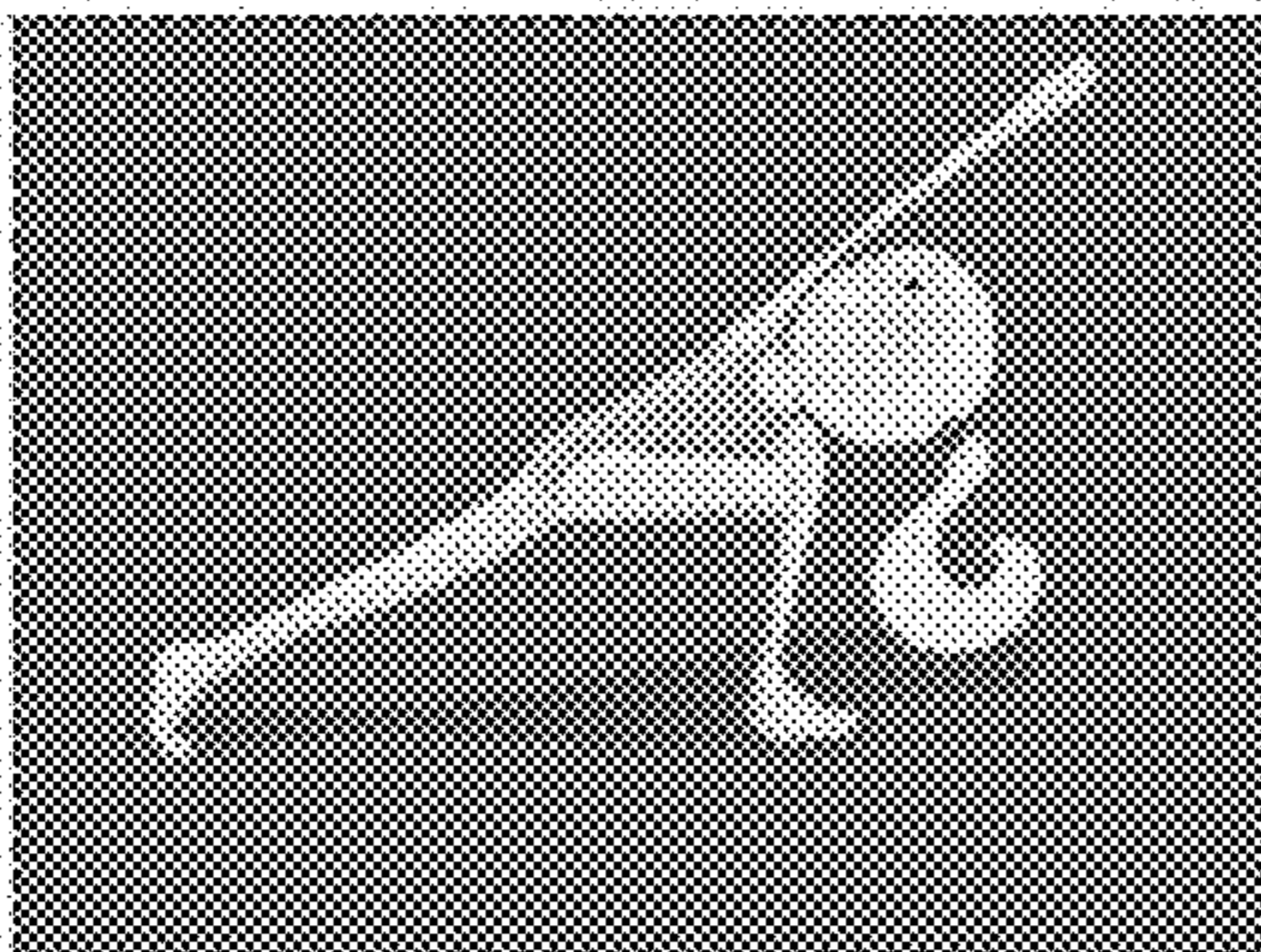

FIG. 63

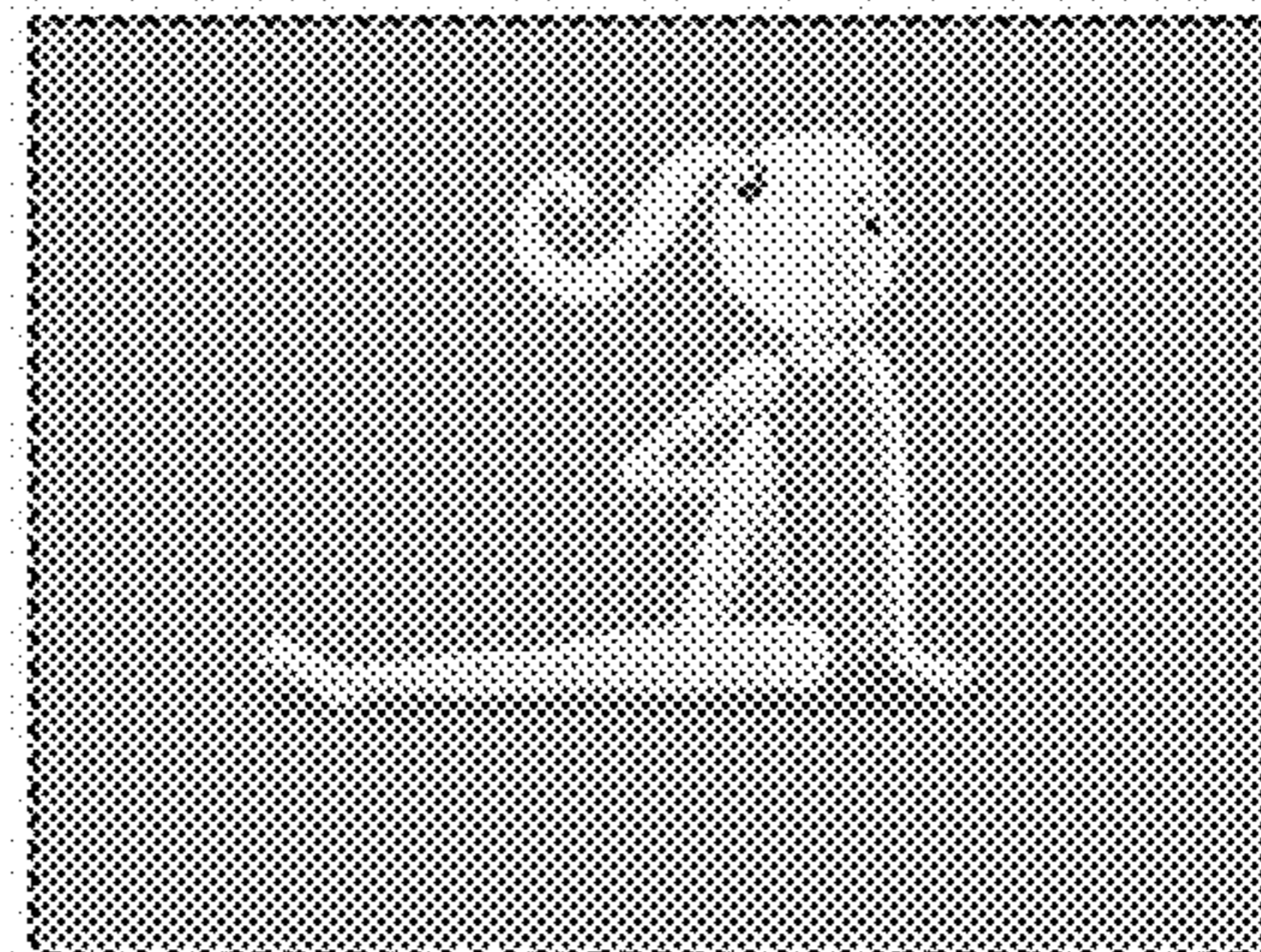

FIG. 64

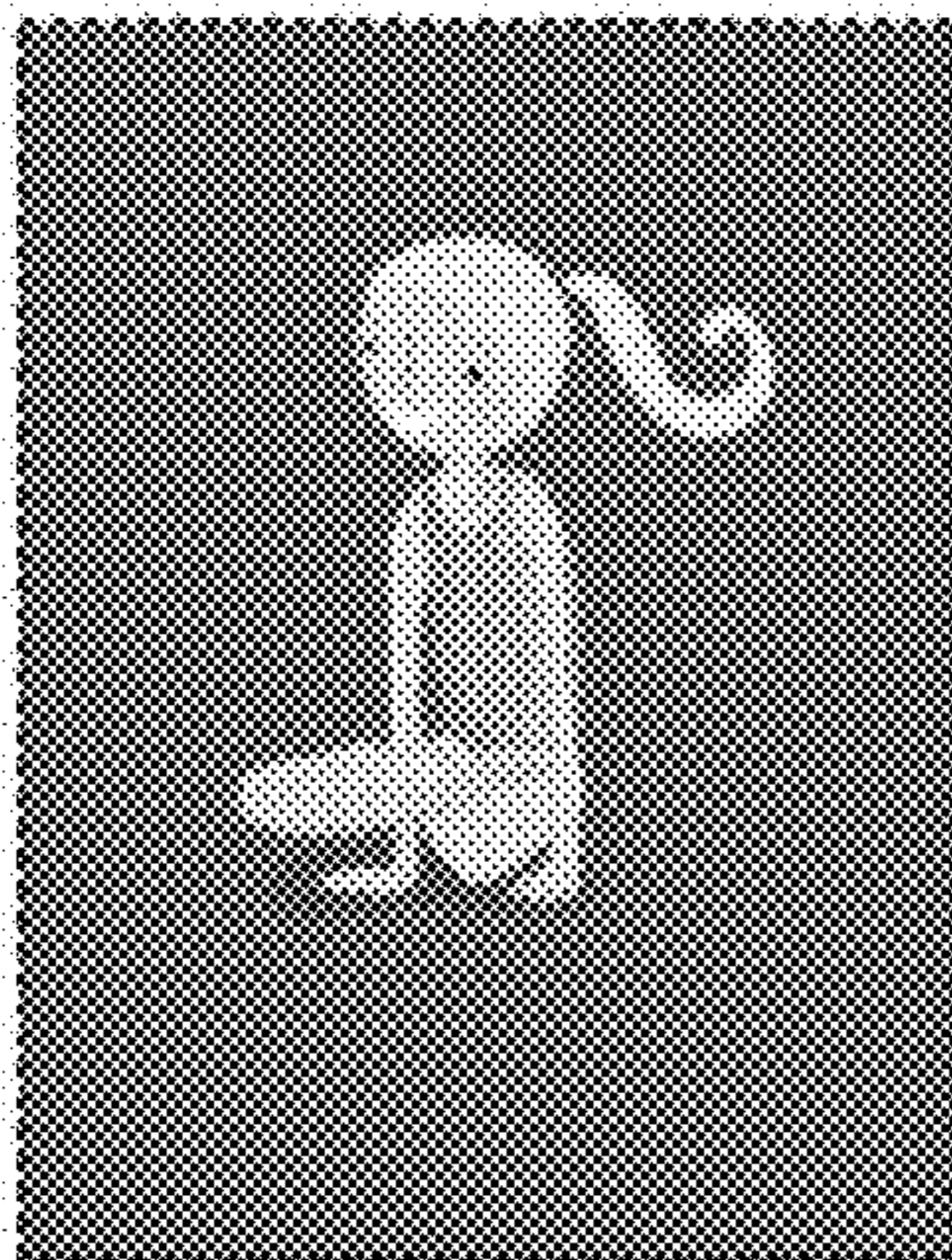

FIG. 65

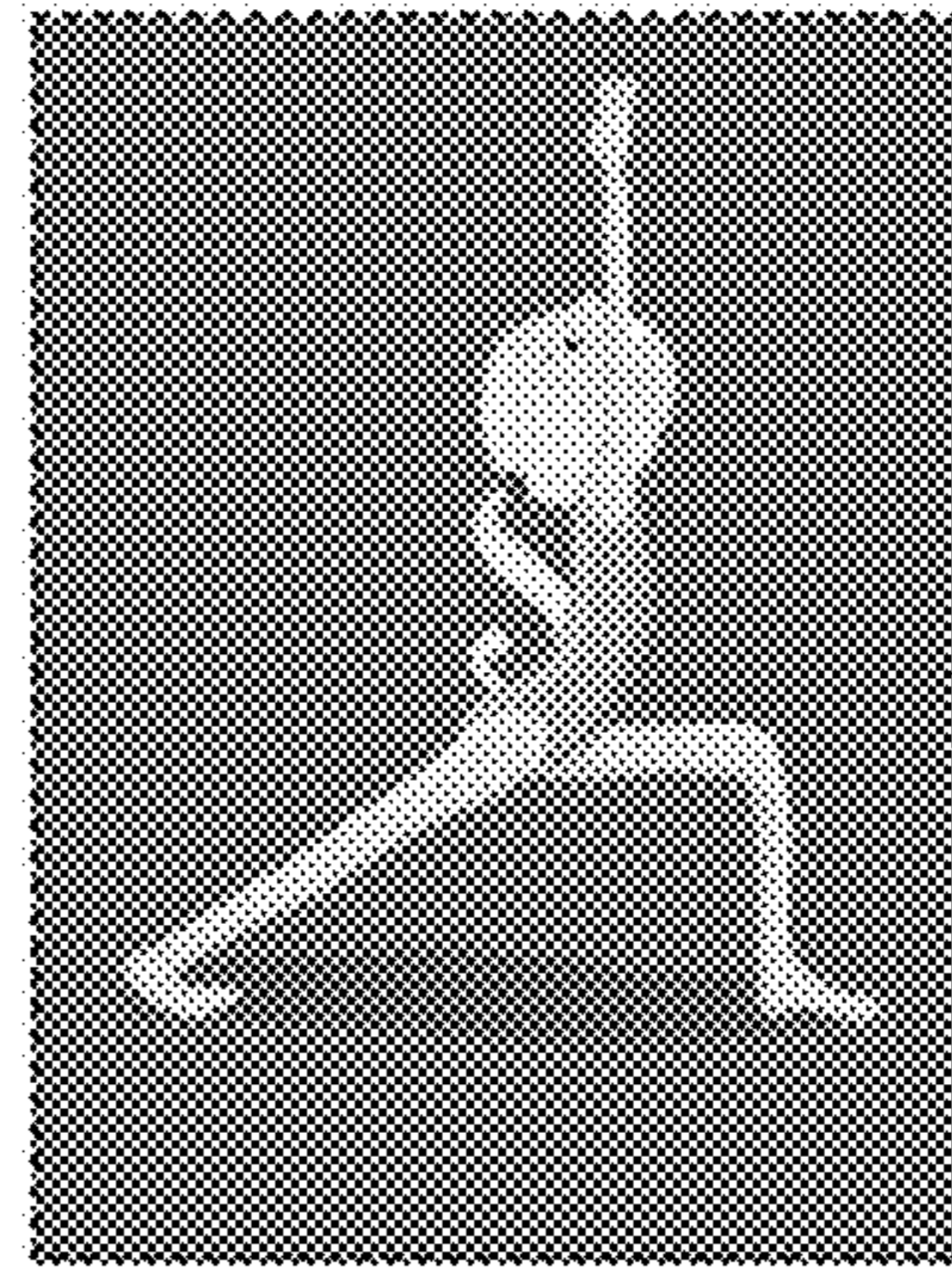

FIG. 66

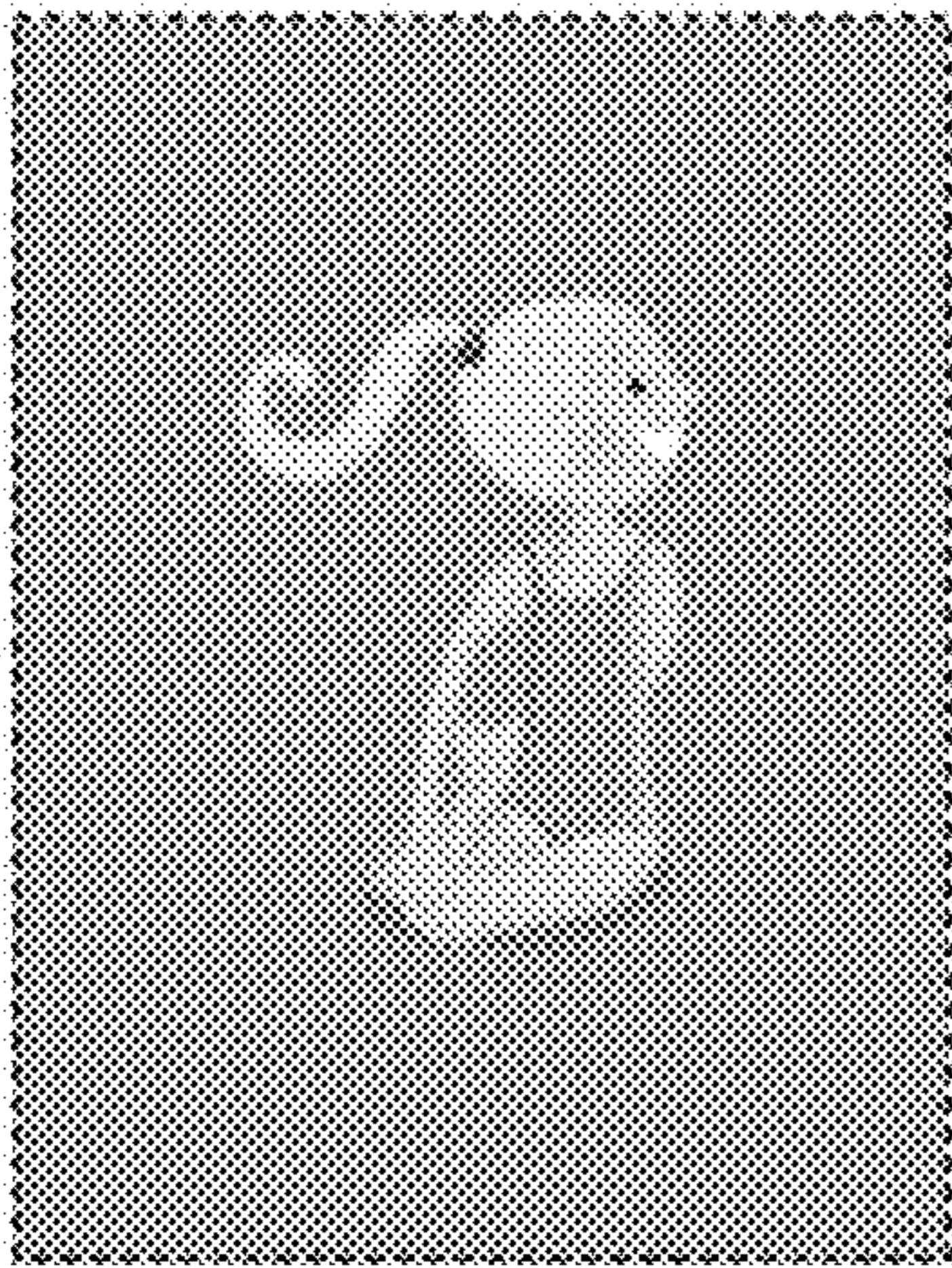

FIG. 67

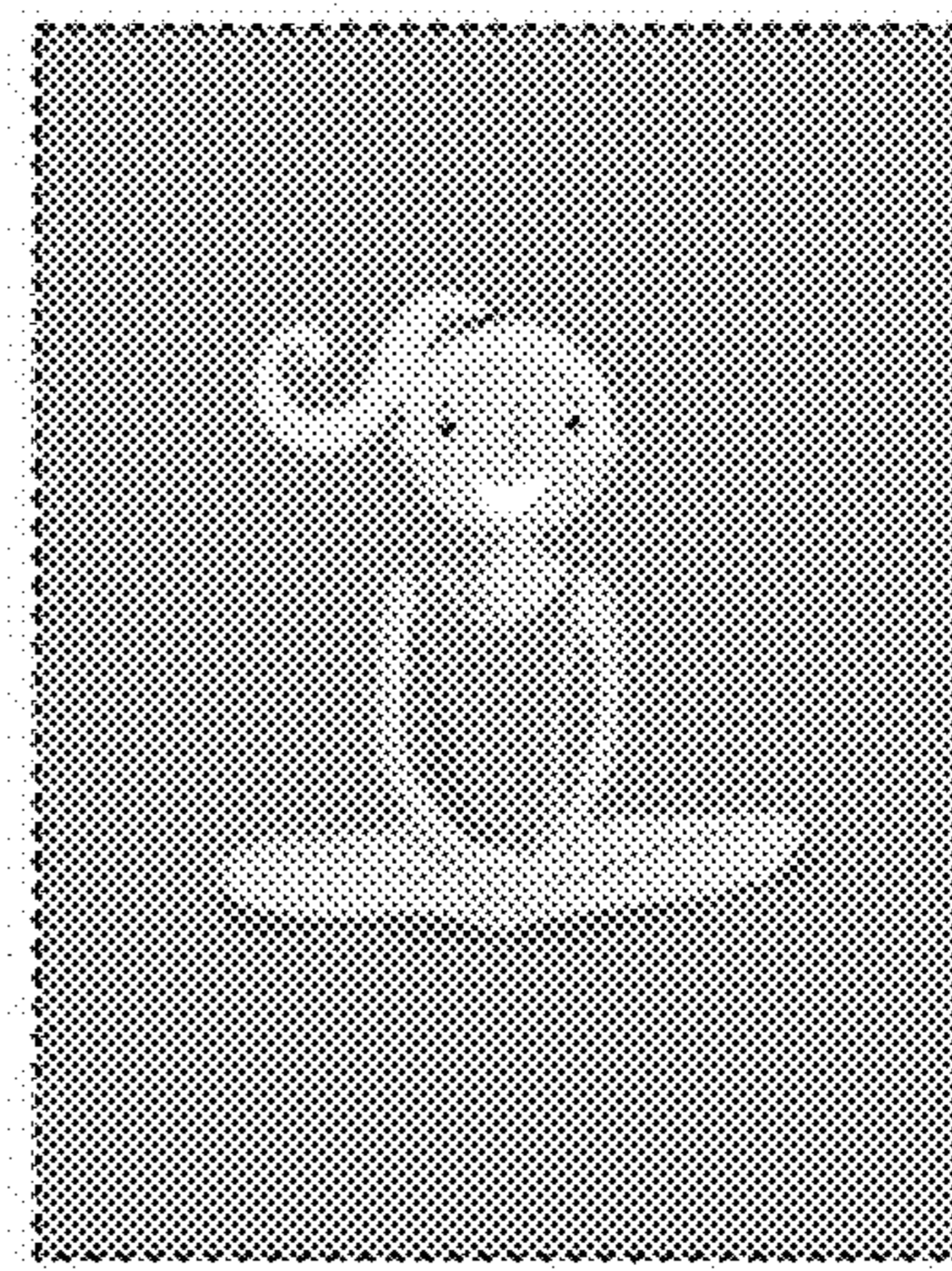

FIG. 68

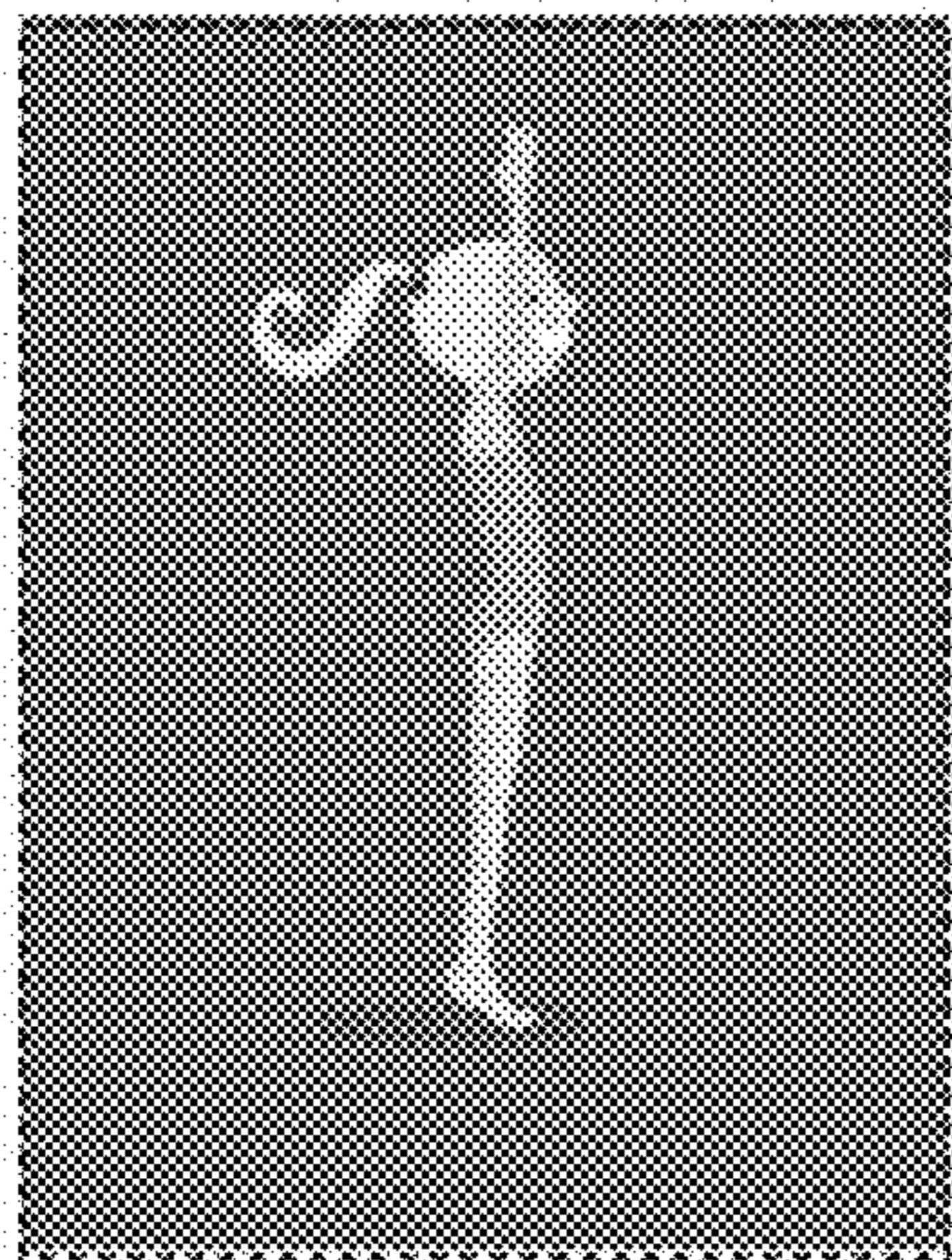

FIG. 69

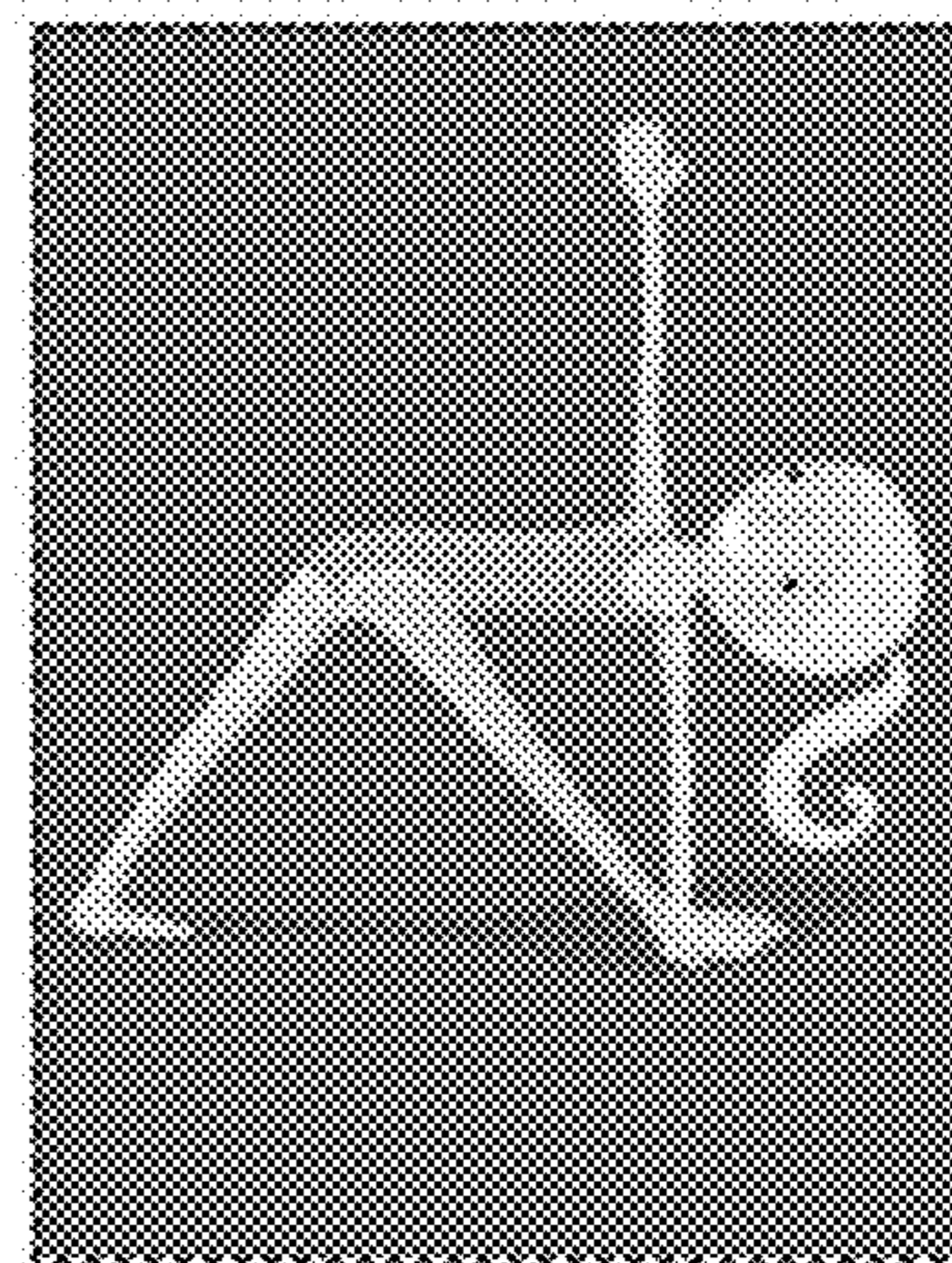

FIG. 70

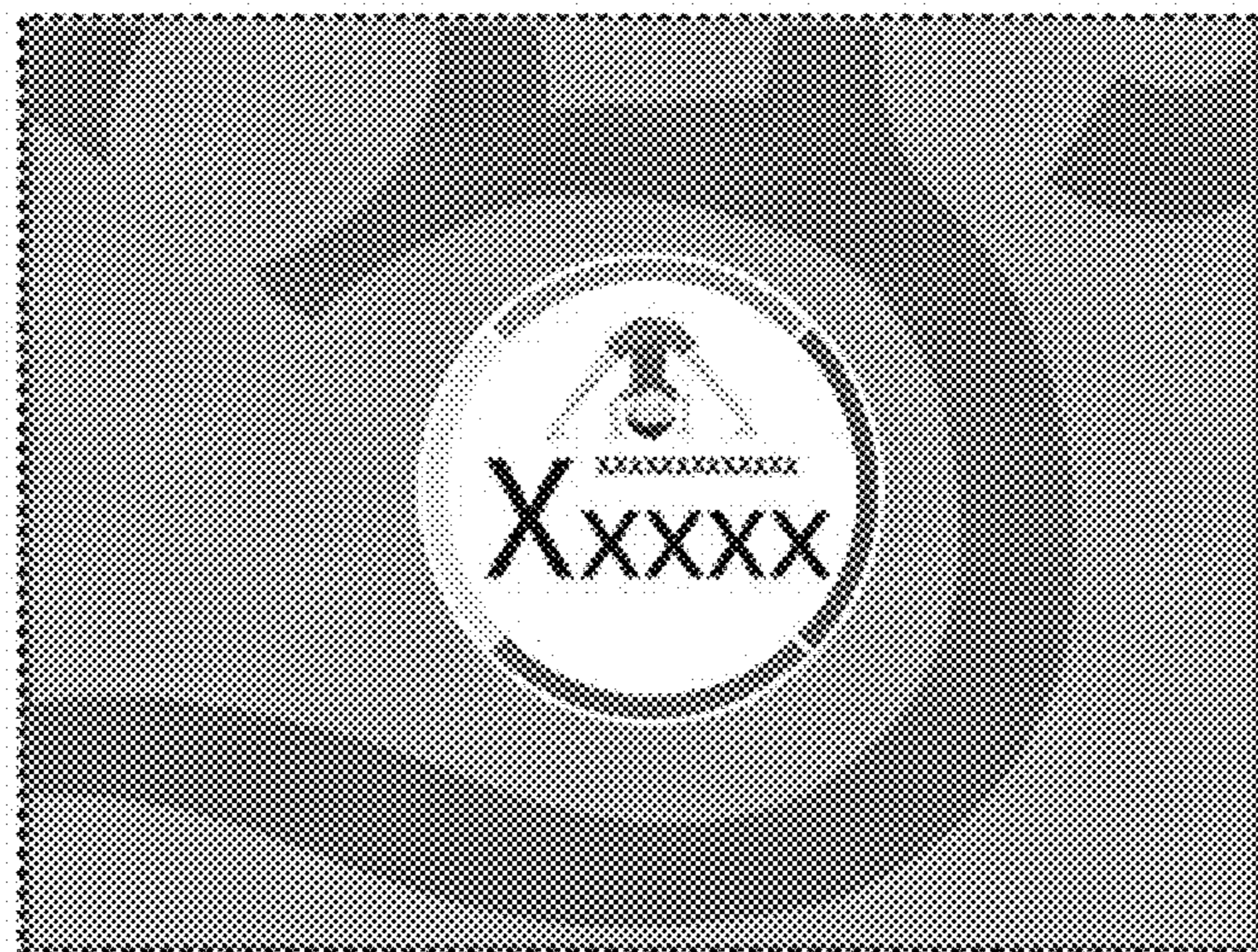

FIG. 71

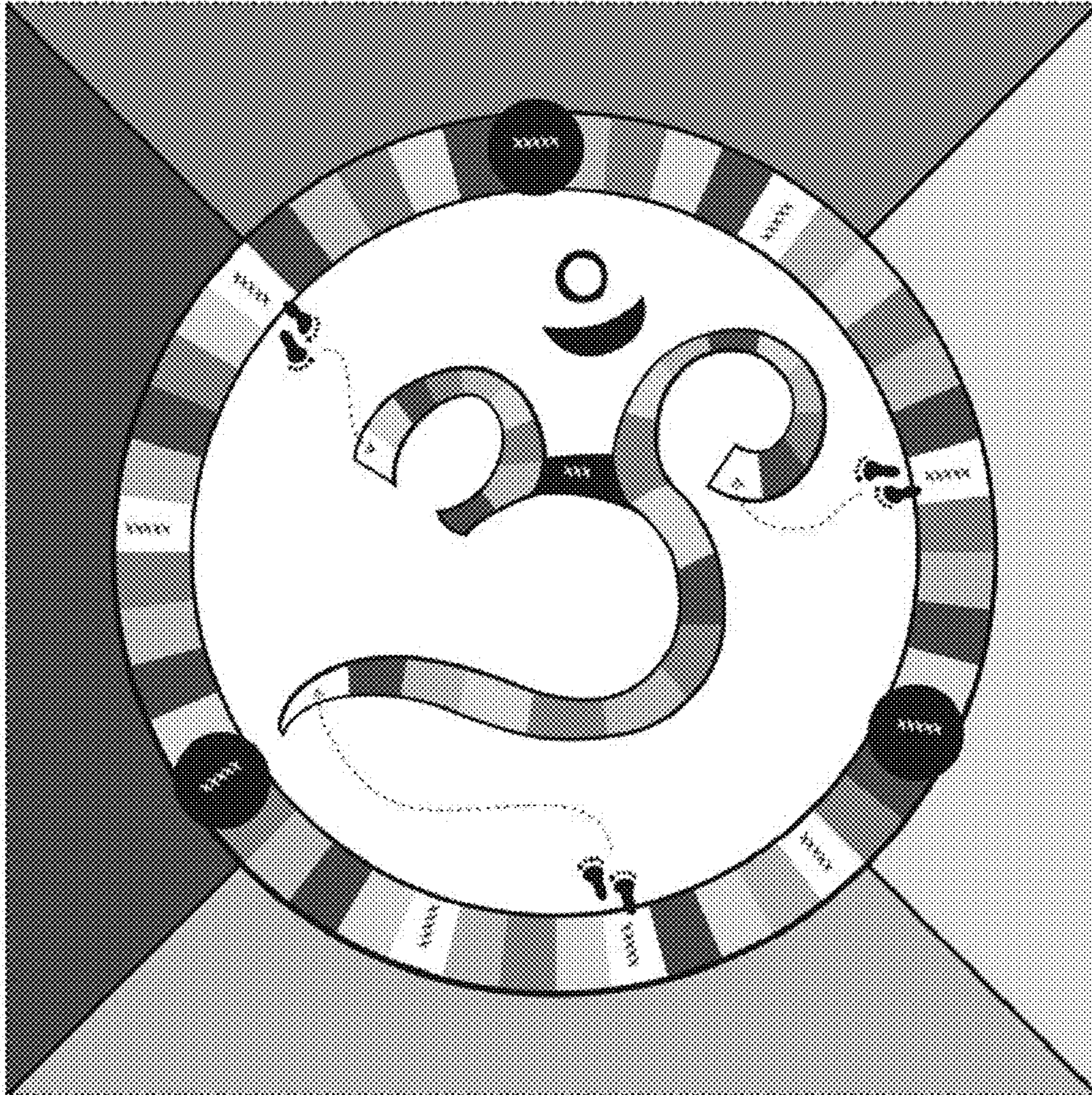

FIG. 72