



US00D612875S

(12) **United States Design Patent**
Beynon

(10) **Patent No.:** **US D612,875 S**
(45) **Date of Patent:** **** Mar. 30, 2010**

(54) **CUTTER WITH PILOT TIP**

(75) Inventor: **Andrew Mark Beynon**, Cambridge (GB)
(73) Assignee: **C4 Carbides Limited**, Cambridge (GB)
(**) Term: **14 Years**
(21) Appl. No.: **29/326,405**
(22) Filed: **Oct. 17, 2008**

(30) **Foreign Application Priority Data**

Apr. 22, 2008 (EM) 000925201

(51) **LOC (9) Cl.** **15-09**
(52) **U.S. Cl.** **D15/139**
(58) **Field of Classification Search** D8/70;
D15/138, 139, 140; 279/62, 902; 299/87.1,
299/107, 109; 403/381; 407/9, 33, 34, 42,
407/54, 63, 110, 113, 114, 115; 408/114,
408/223

See application file for complete search history.

(56) **References Cited**

U.S. PATENT DOCUMENTS

D148,211 S * 12/1947 Bamberger D15/140
D221,048 S * 7/1971 Bixby D8/70
D285,798 S * 9/1986 Brunnegard et al. D15/143
D287,857 S * 1/1987 Inoue D15/139
5,111,801 A * 5/1992 Katoh 125/23.01

(Continued)

Primary Examiner—Sandra Snapp
Assistant Examiner—Patricia Palasik
(74) *Attorney, Agent, or Firm*—Nixon & Vanderhye P.C.

(57) **CLAIM**

The ornamental design for a cutter with pilot tip, as shown and described.

DESCRIPTION

FIG. 1 is a perspective view depicting a cutter with pilot tip of a first embodiment;

FIG. 2 is a front view thereof;
FIG. 3 is a rear view thereof;
FIG. 4 is a side view thereof;
FIG. 5 is an opposite side view thereof;
FIG. 6 is a back end view thereof; and
FIG. 7 is a tip end view thereof.
FIG. 8 is a perspective view depicting a cutter with pilot tip of a second embodiment;
FIG. 9 is a front view thereof;
FIG. 10 is a rear view thereof;
FIG. 11 is a side view thereof;
FIG. 12 is an opposite side view thereof;
FIG. 13 is a back end view thereof; and
FIG. 14 is a tip end view thereof.
FIG. 15 is a perspective view depicting a cutter with pilot tip of a third embodiment;
FIG. 16 is a front view thereof;
FIG. 17 is a rear view thereof;
FIG. 18 is a side view thereof;
FIG. 19 is an opposite side view thereof;
FIG. 20 is a back end view thereof; and
FIG. 21 is a tip end view thereof.
FIG. 22 is a perspective view depicting a cutter with pilot tip of a fourth embodiment;
FIG. 23 is a front view thereof;
FIG. 24 is a rear view thereof;
FIG. 25 is a side view thereof;
FIG. 26 is an opposite side view thereof;
FIG. 27 is a back end view thereof; and
FIG. 28 is a tip end view thereof.

1 Claim, 24 Drawing Sheets

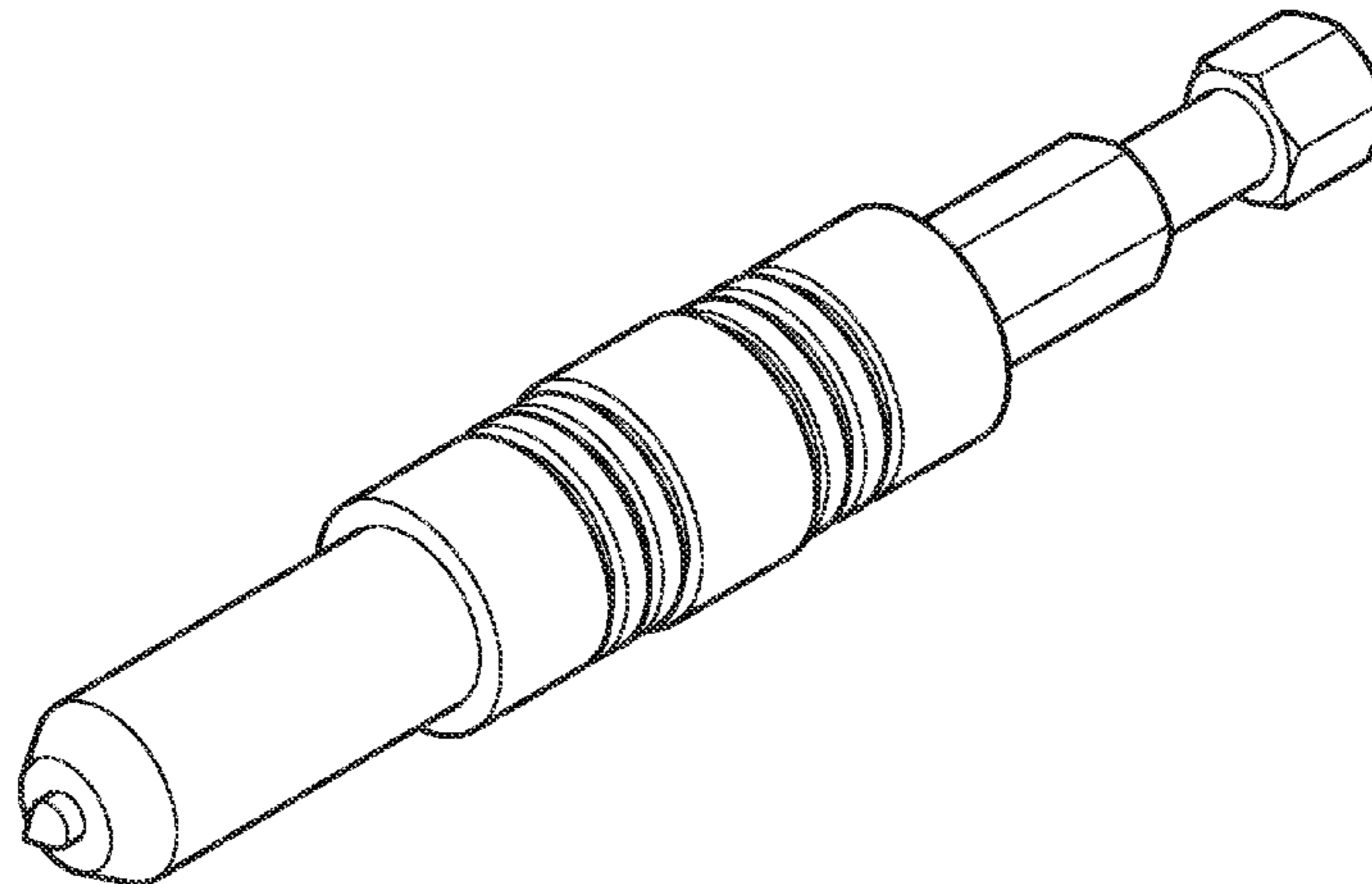

US D612,875 S

Page 2

U.S. PATENT DOCUMENTS

D330,900 S	*	11/1992	Wakegijig	D15/138	D479,253 S	*	9/2003	Chen	D15/140
D363,294 S	*	10/1995	Ellis	D15/139	D497,300 S	*	10/2004	Chen	D8/85
D379,578 S	*	6/1997	Daniels	D8/70	D570,663 S	*	6/2008	Duggan	D8/70
D415,180 S	*	10/1999	Rosanwo	D15/140	D589,319 S	*	3/2009	Peters	D8/70
D478,263 S	*	8/2003	Welsh	D8/70	D594,306 S	*	6/2009	Decker	D8/70
						D596,003 S	*	7/2009	Collier	D8/29

* cited by examiner

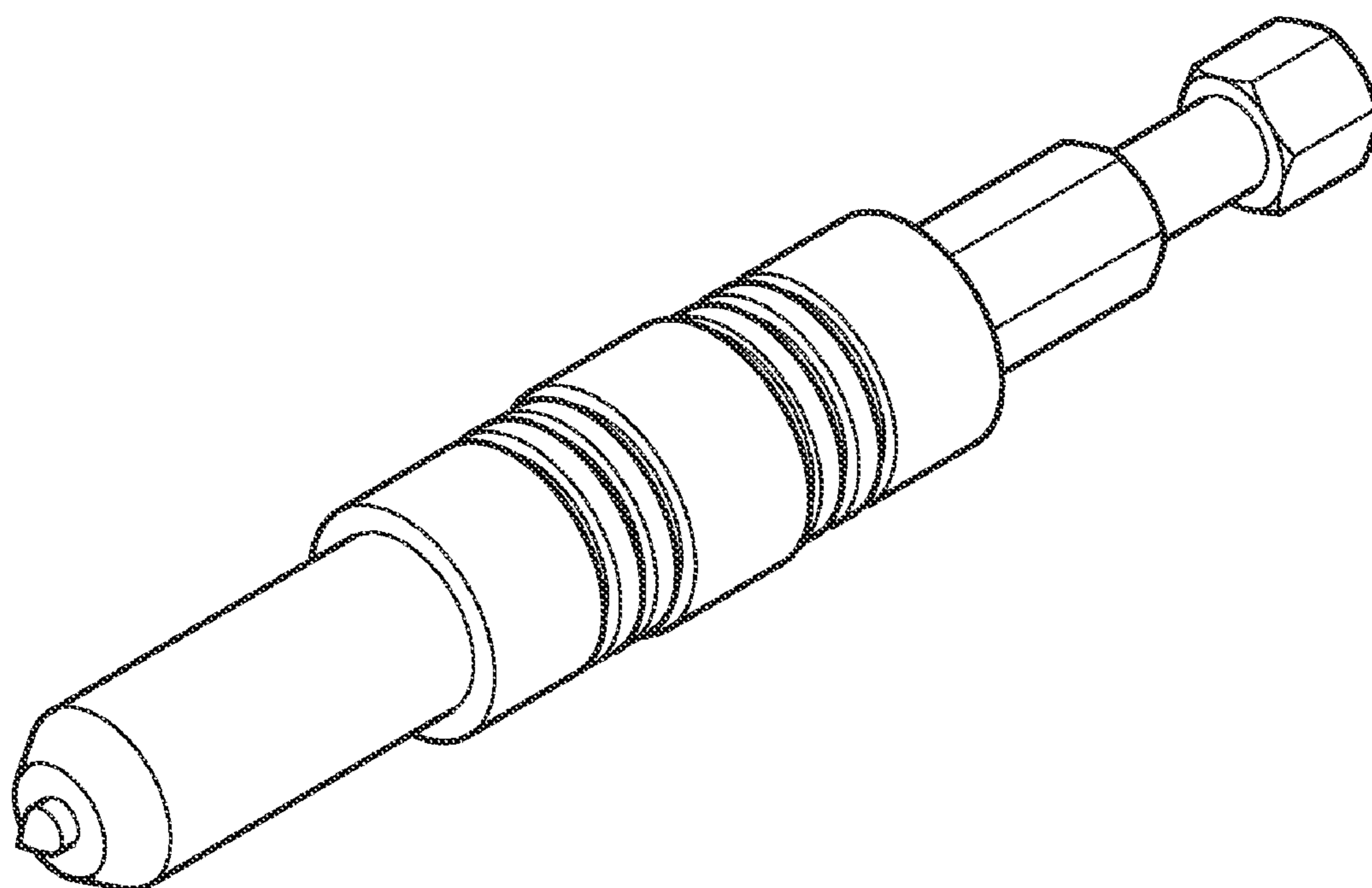

Fig. 1

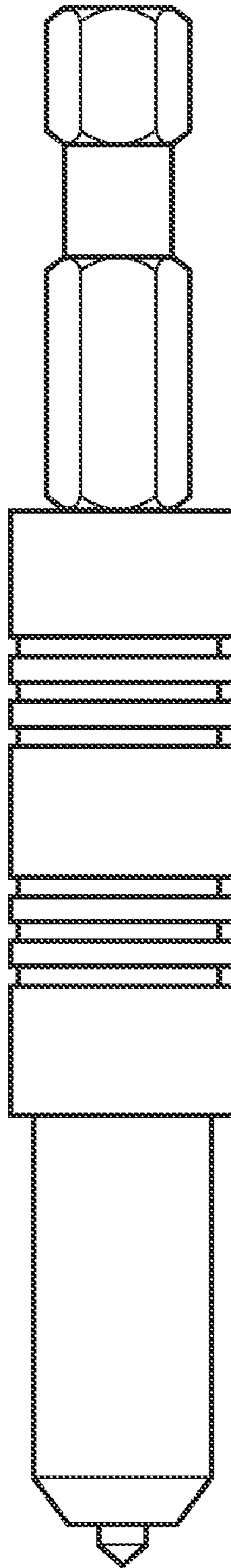

Fig. 2

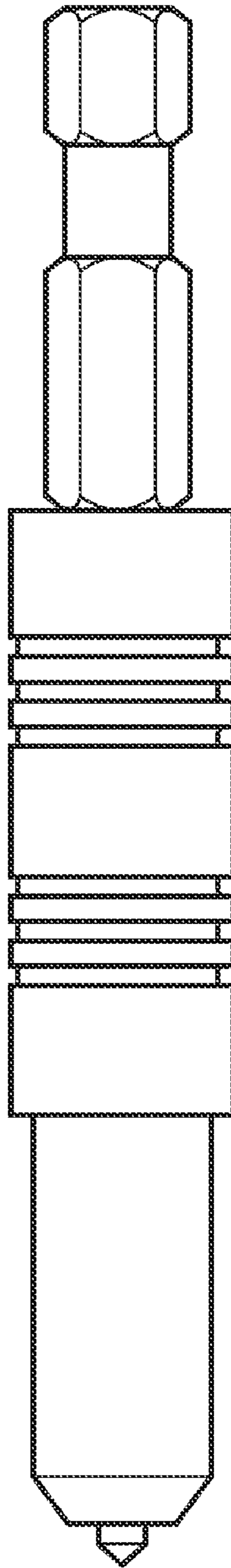

Fig. 3

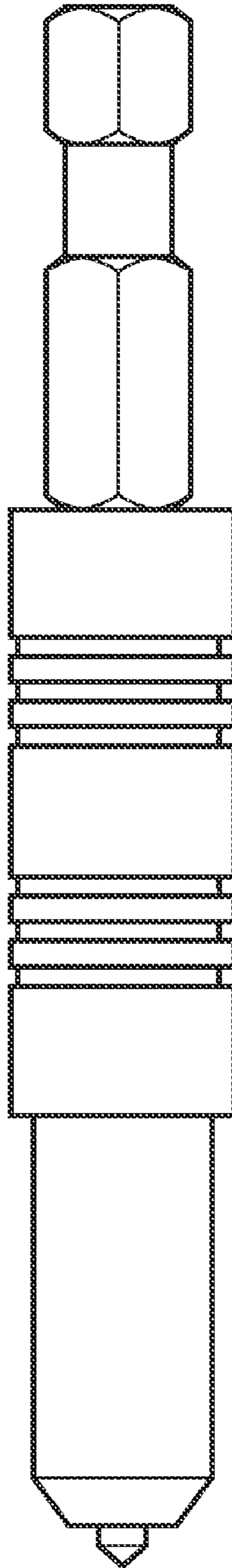

Fig. 4

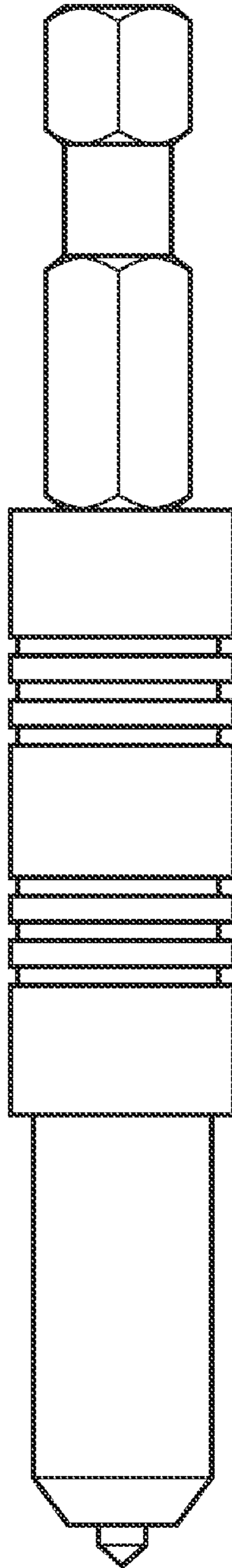

Fig. 5

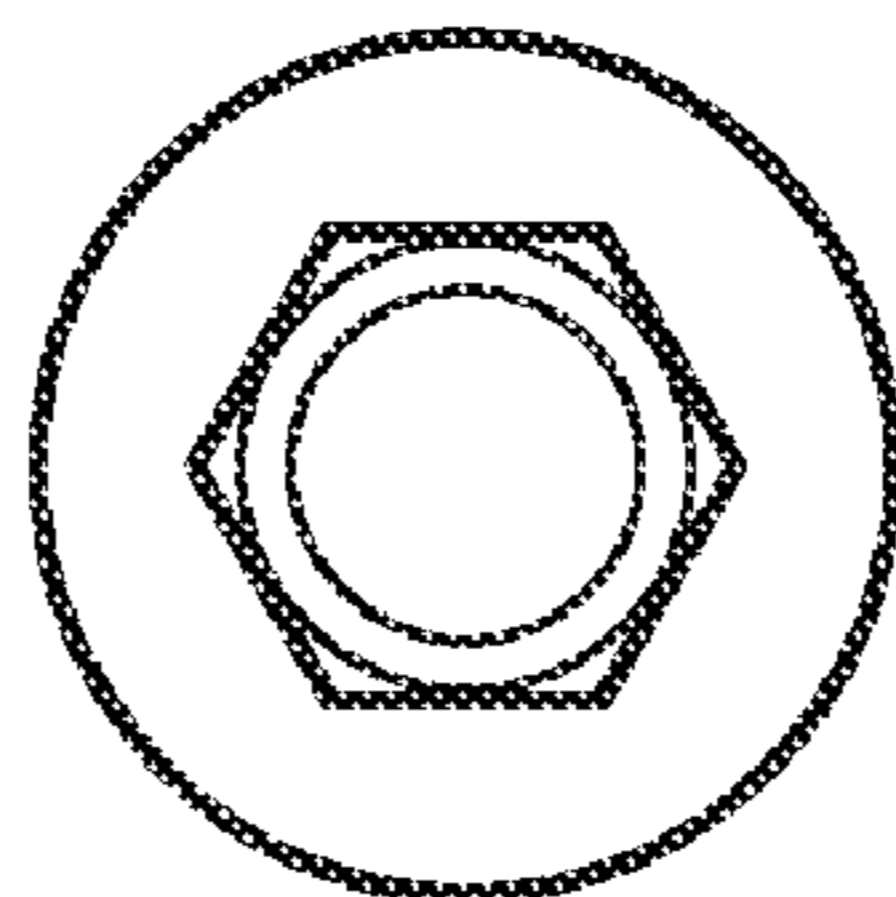

Fig. 6

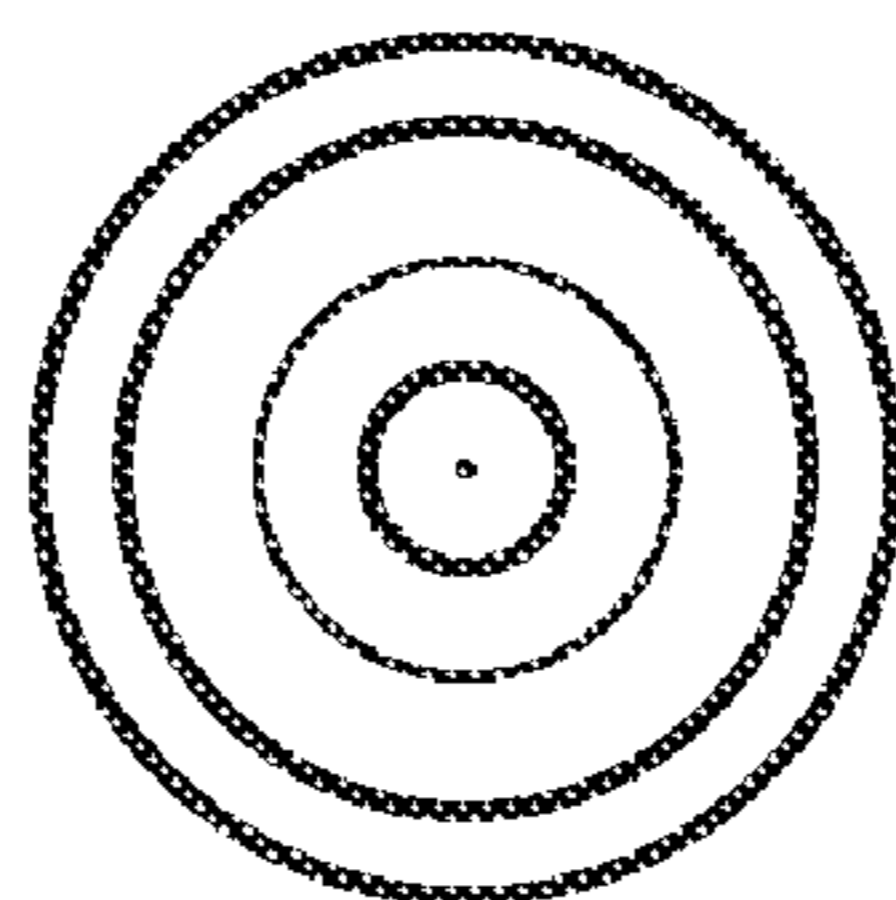

Fig. 7

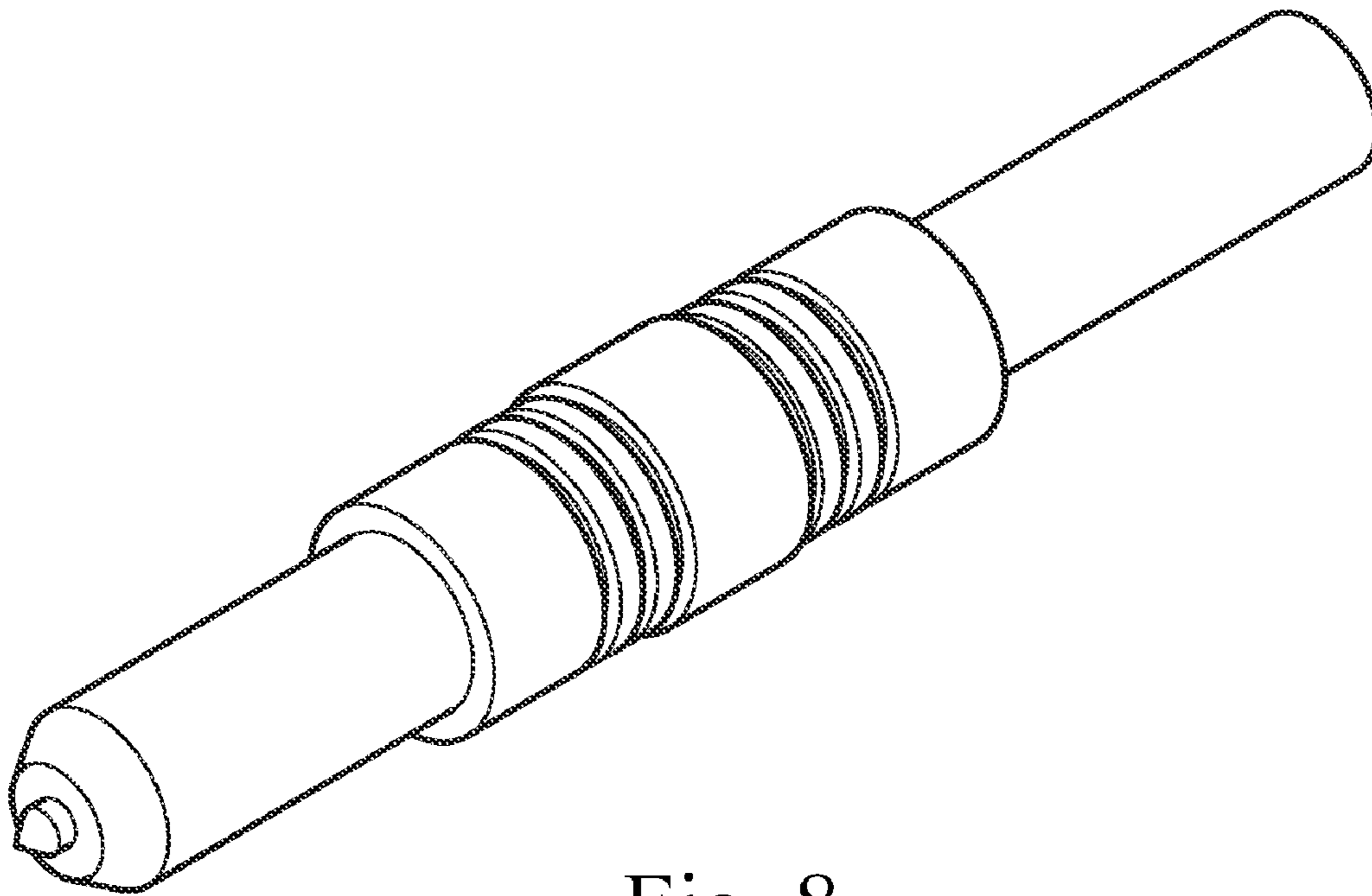

Fig. 8

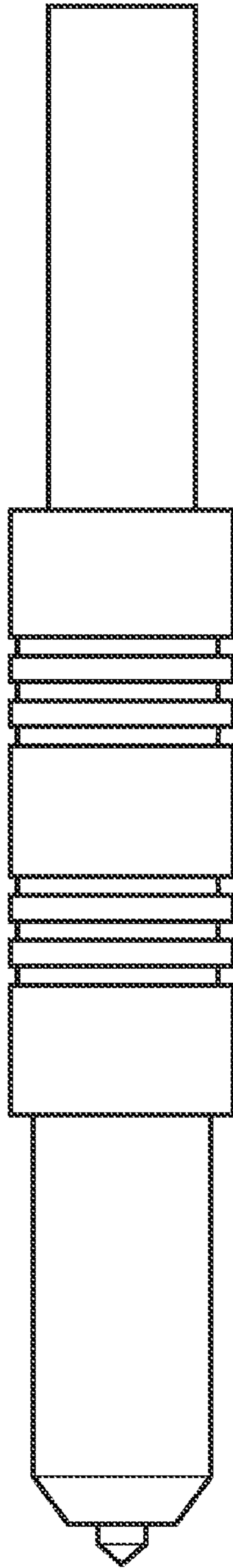

Fig. 9

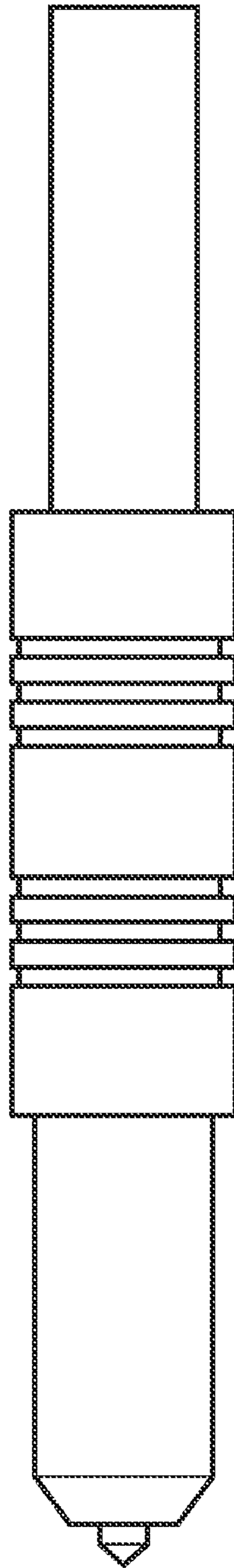

Fig. 10

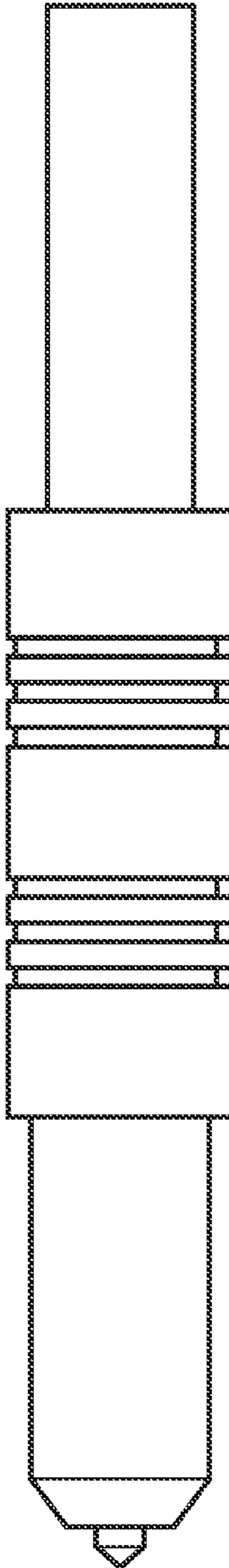

Fig. 11

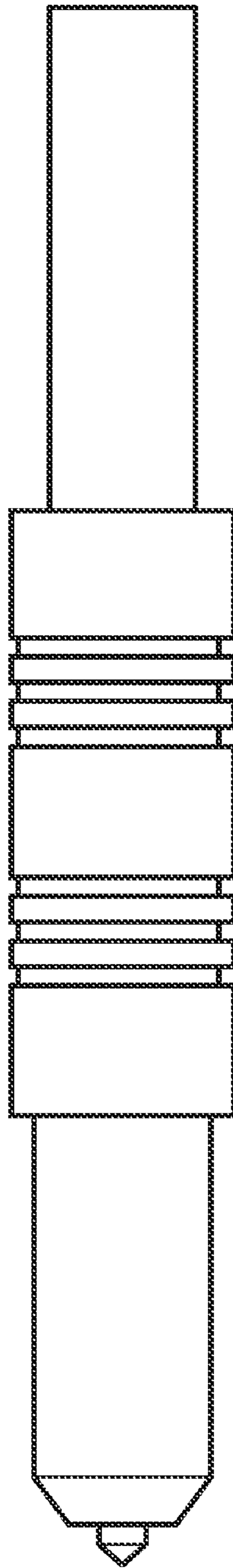

Fig. 12

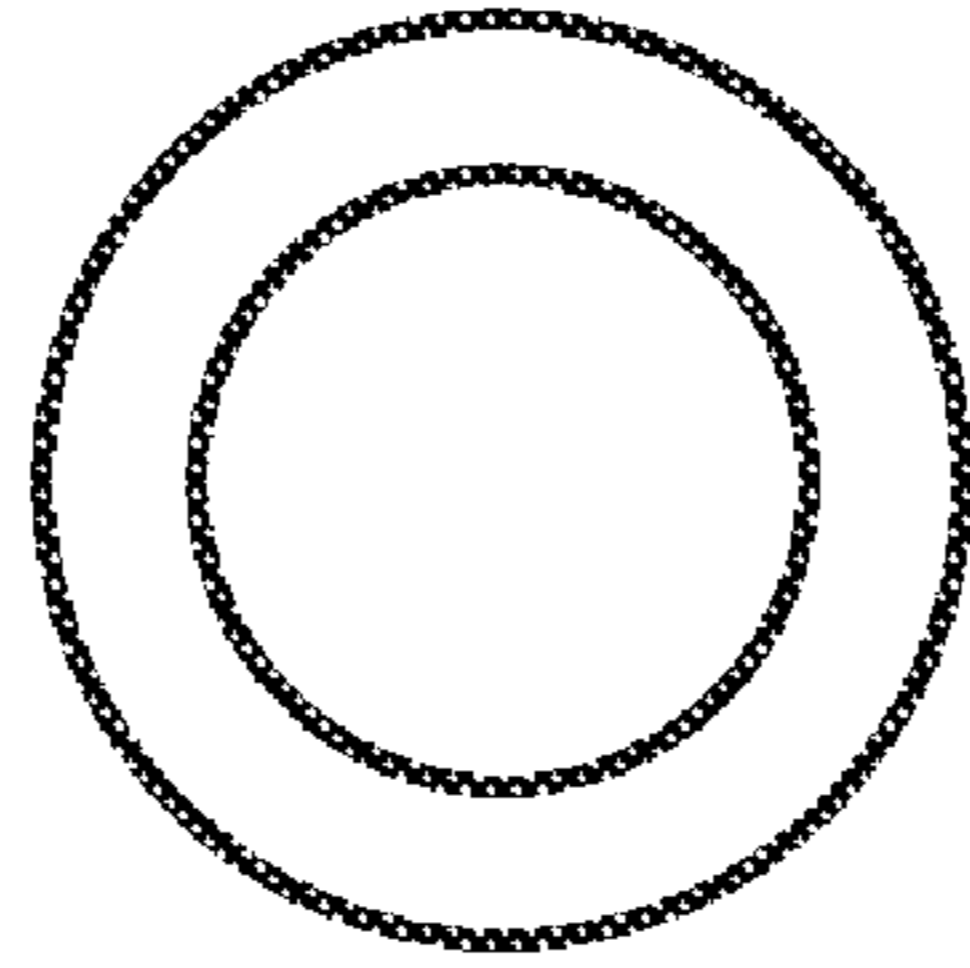

Fig. 13

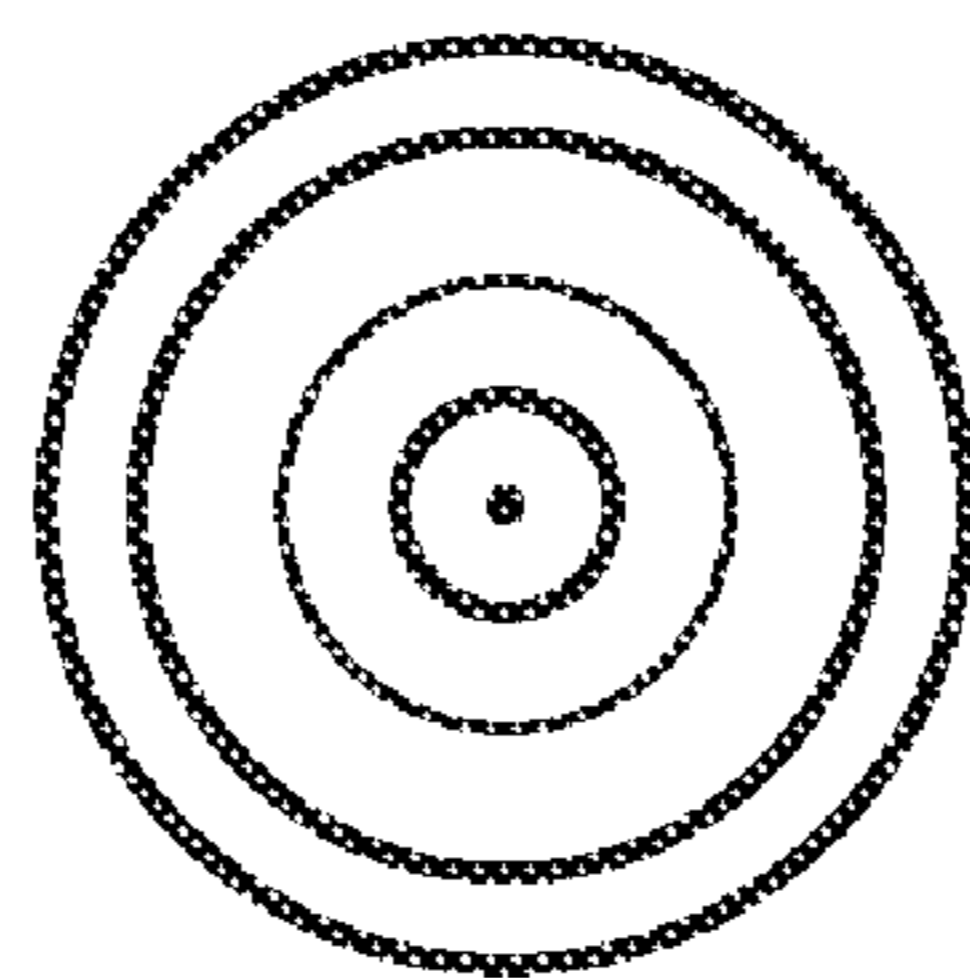

Fig. 14

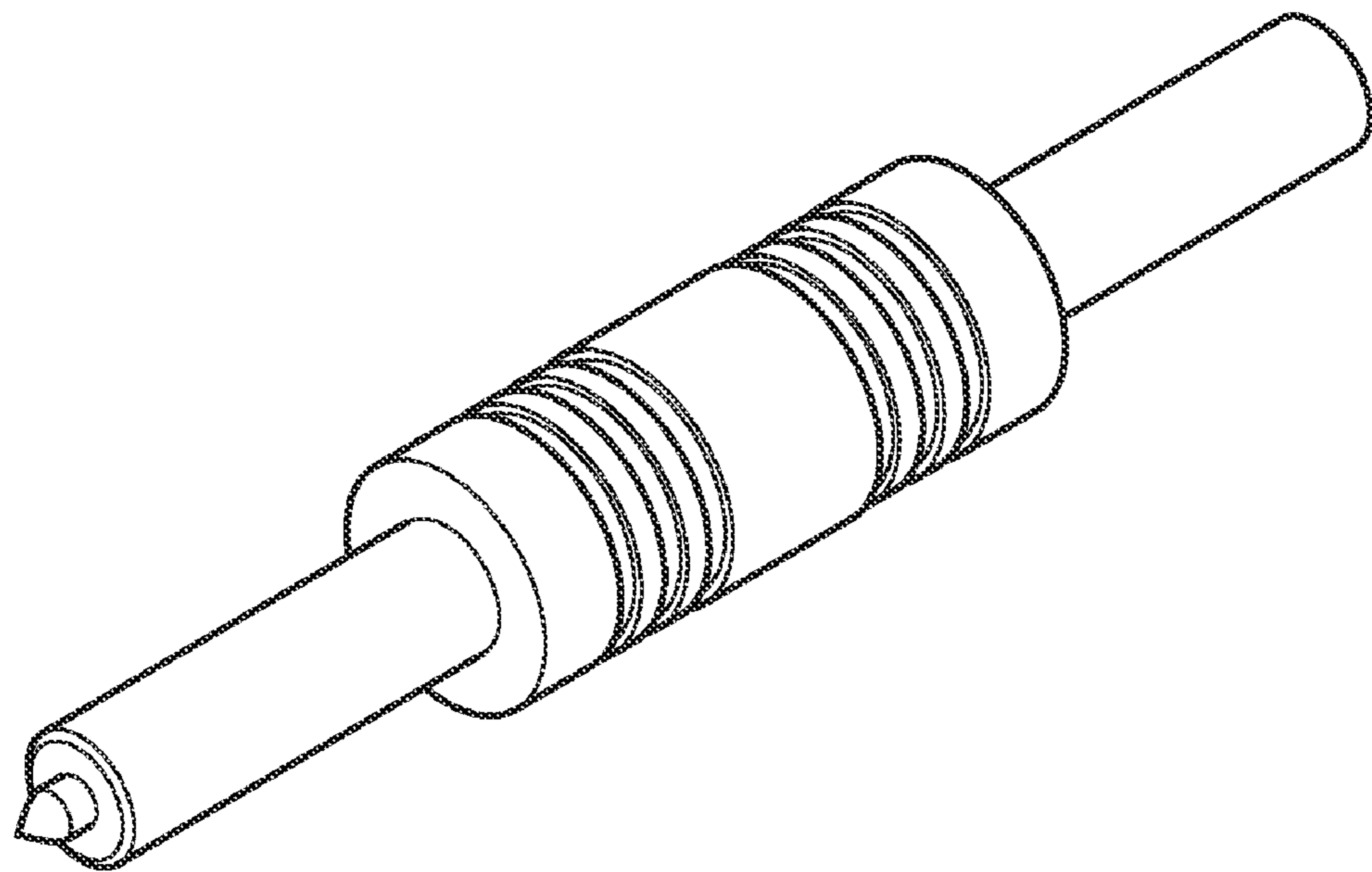

Fig. 15

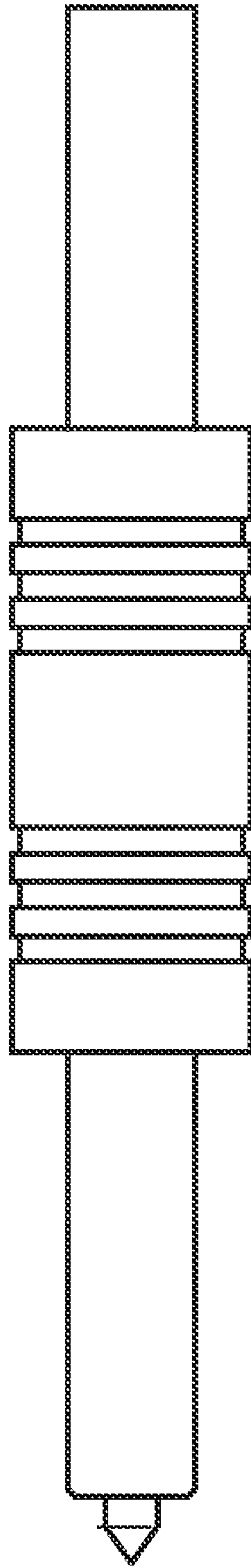

Fig. 16

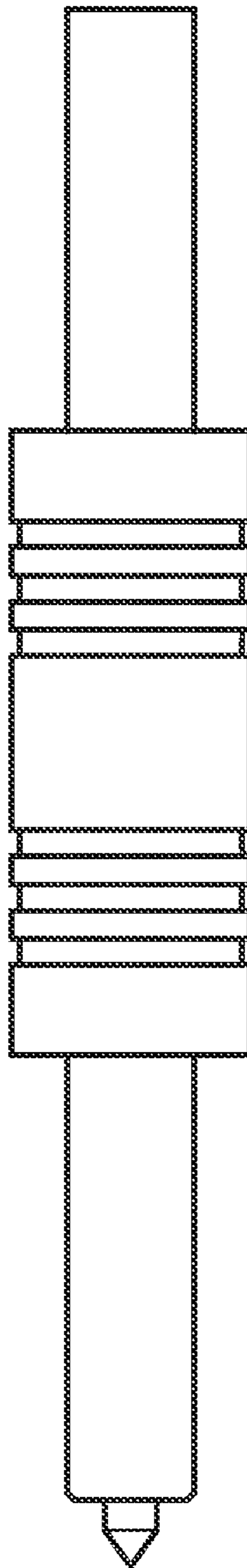

Fig. 17

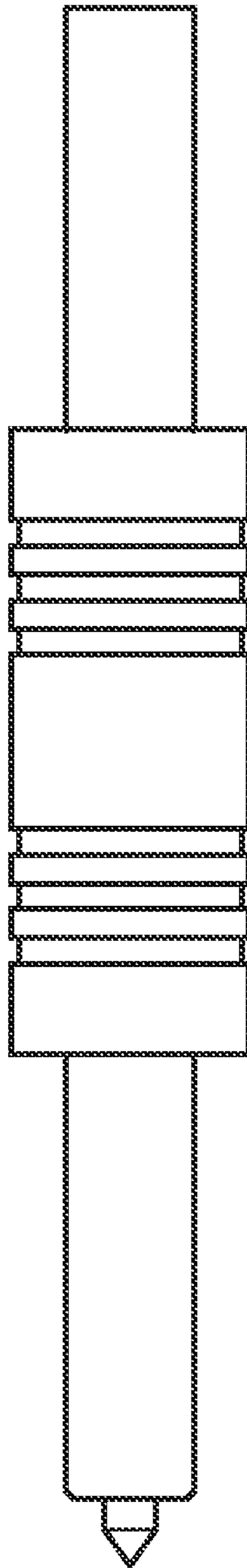

Fig. 18

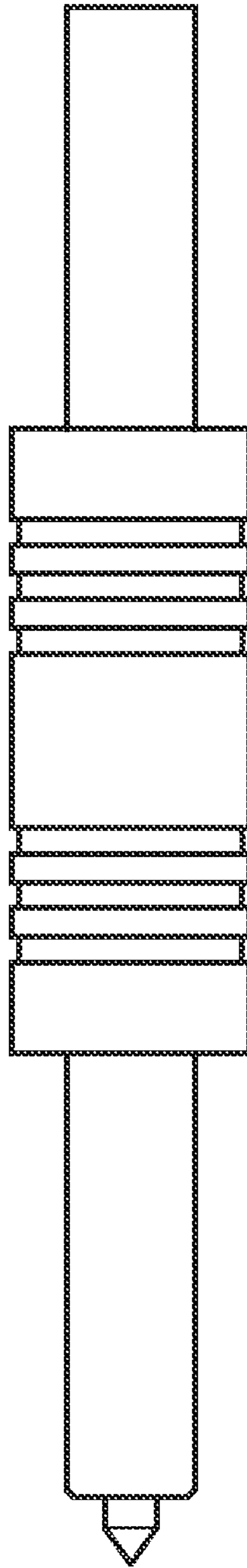

Fig. 19

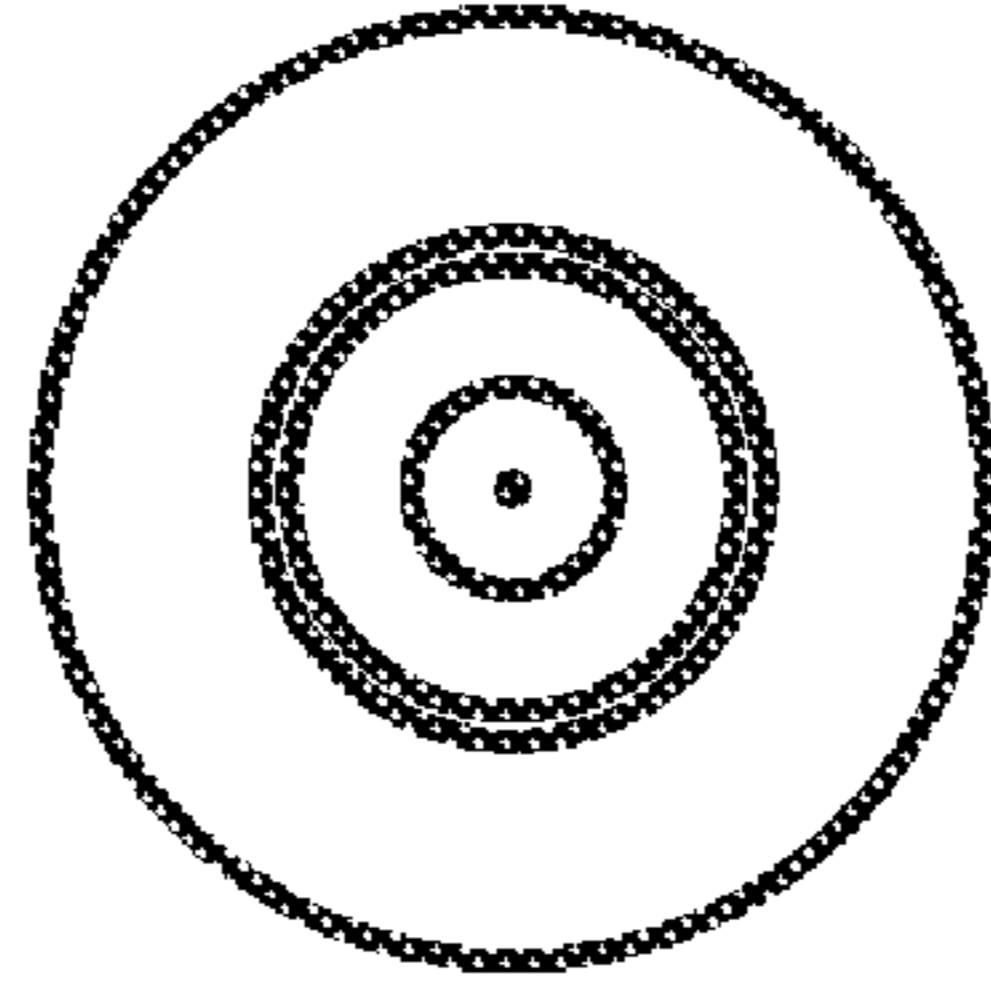

Fig. 20

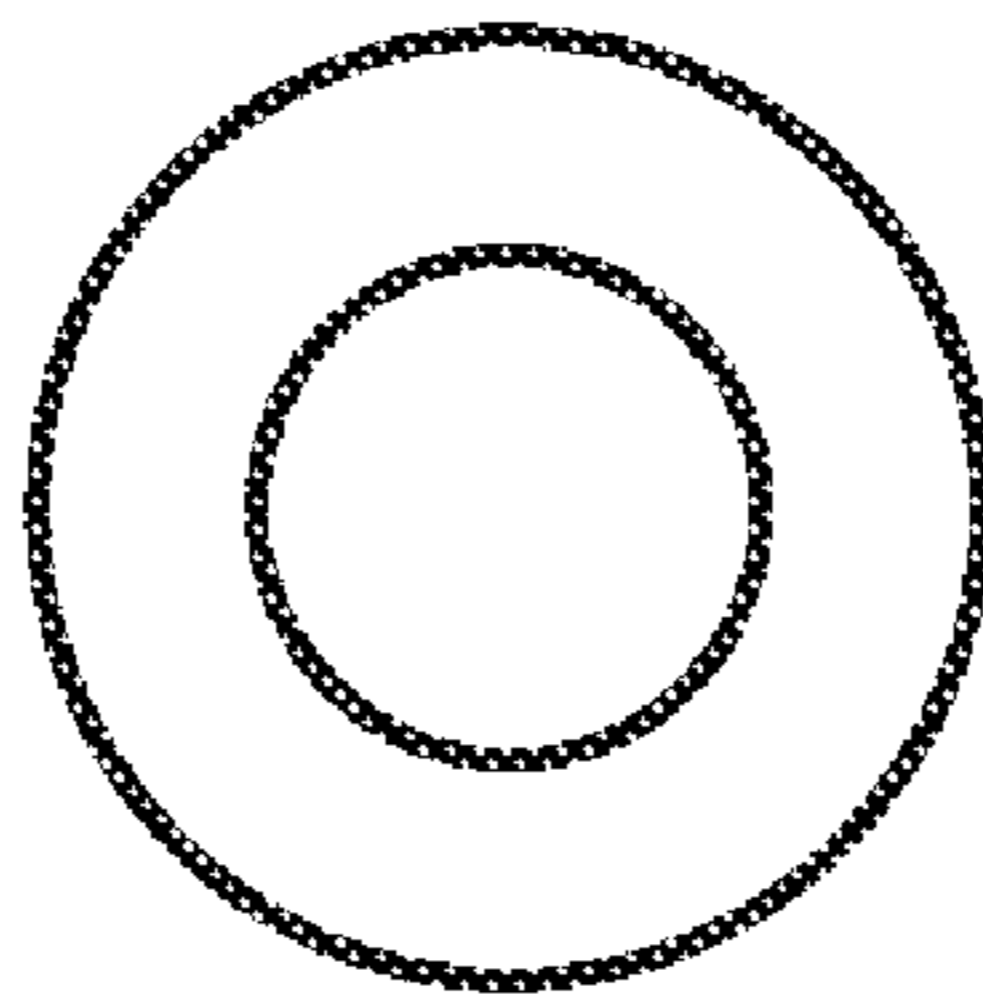

Fig. 21

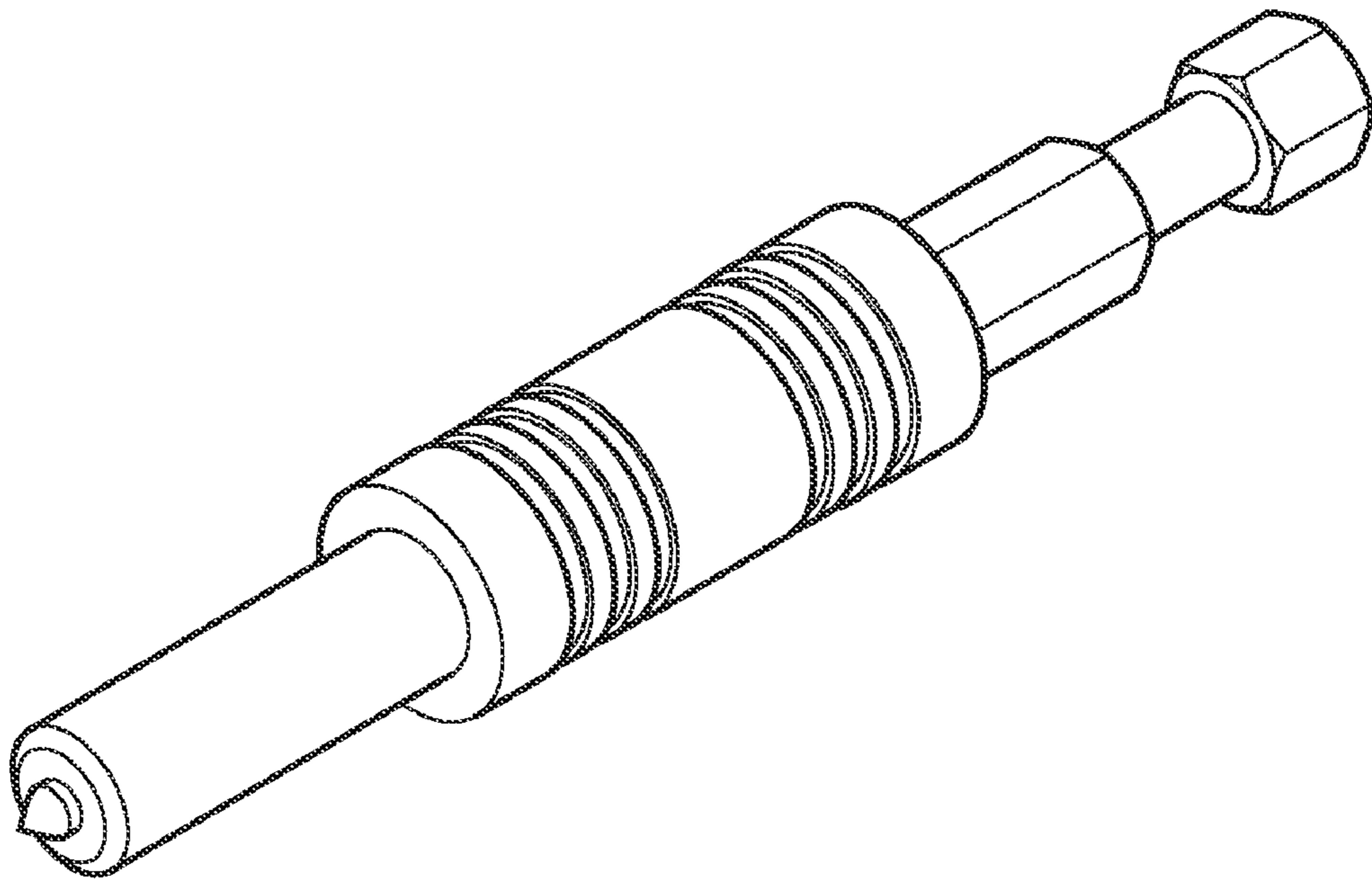

Fig. 22

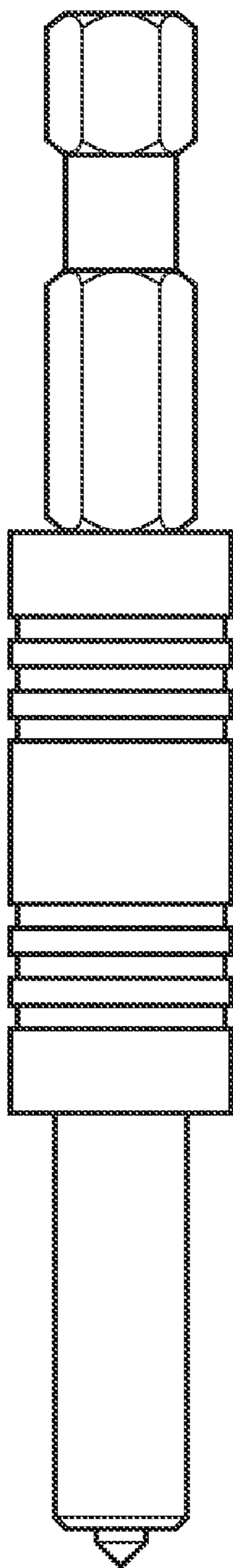

Fig. 23

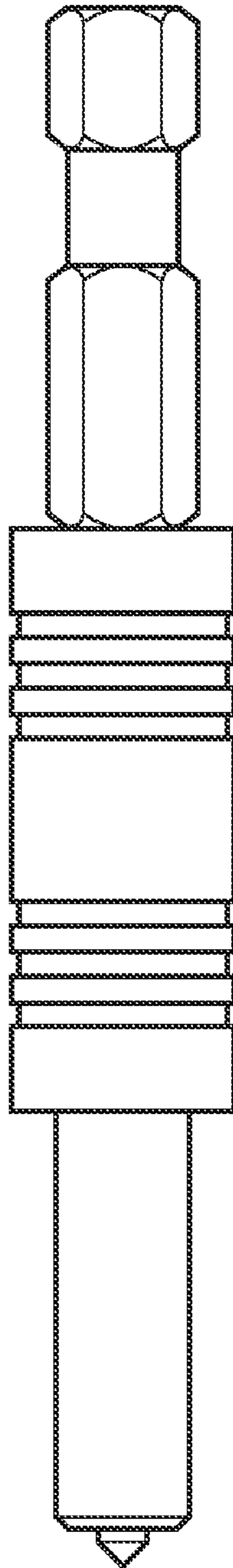

Fig. 24

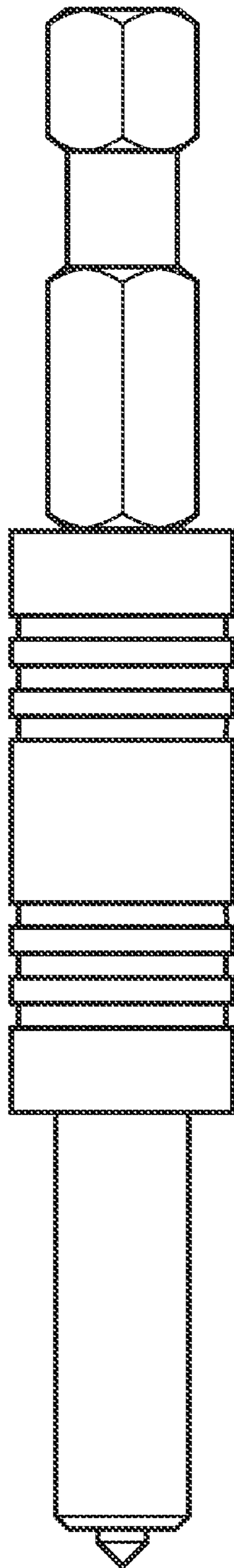

Fig. 25

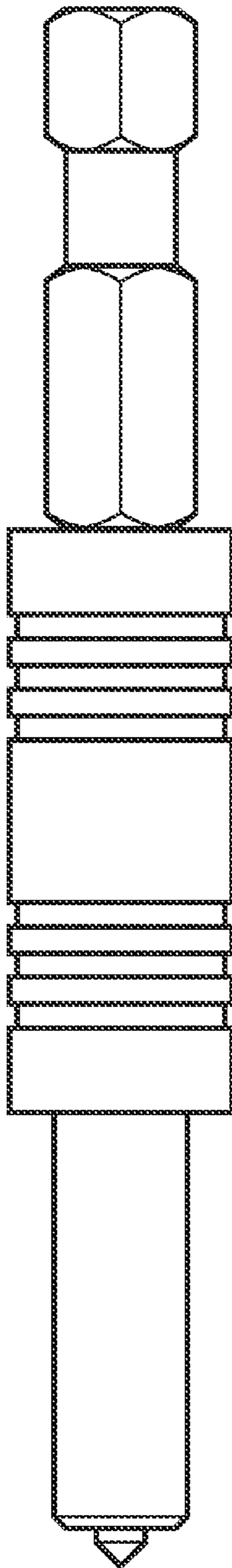

Fig. 26

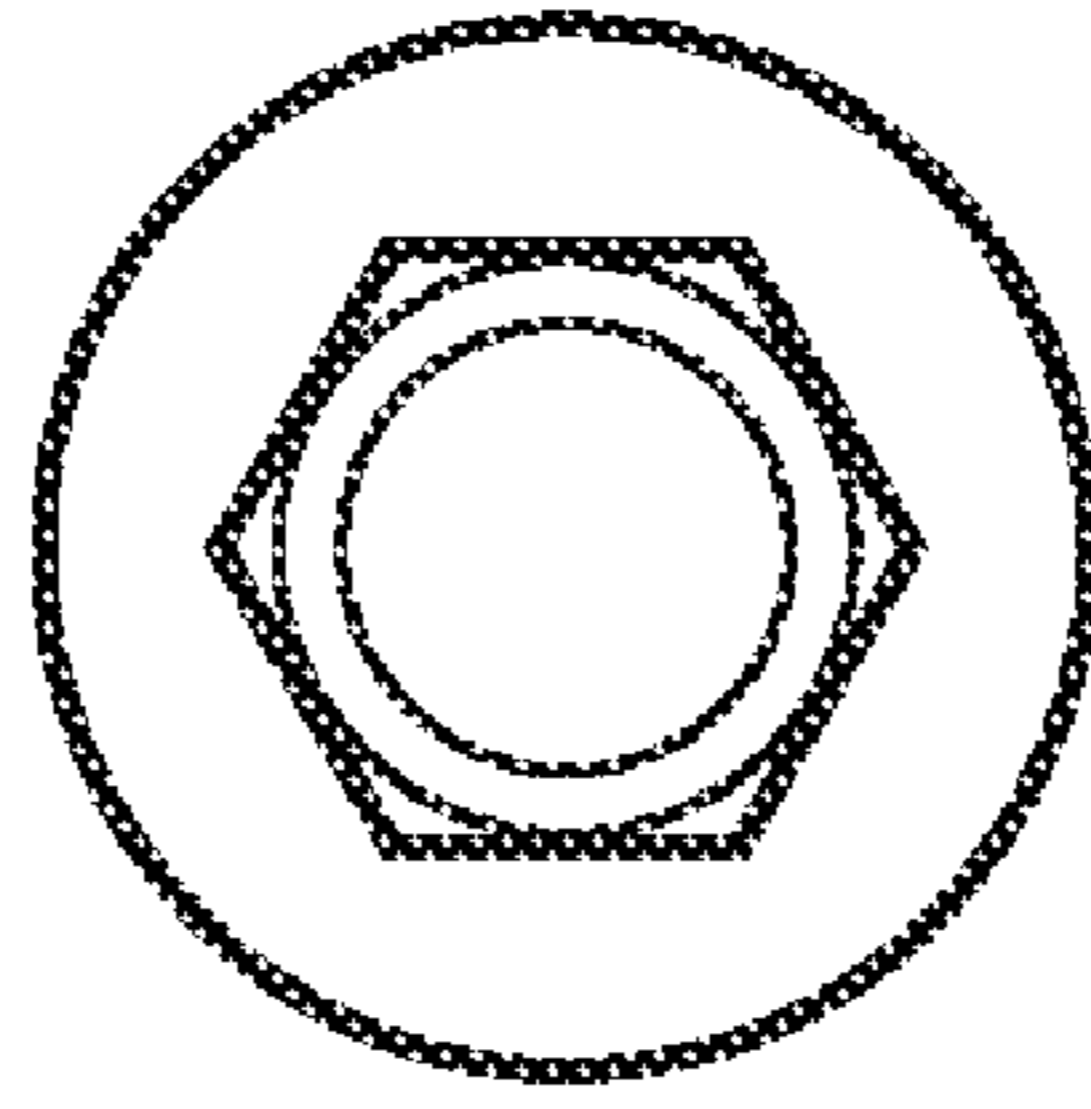

Fig. 27

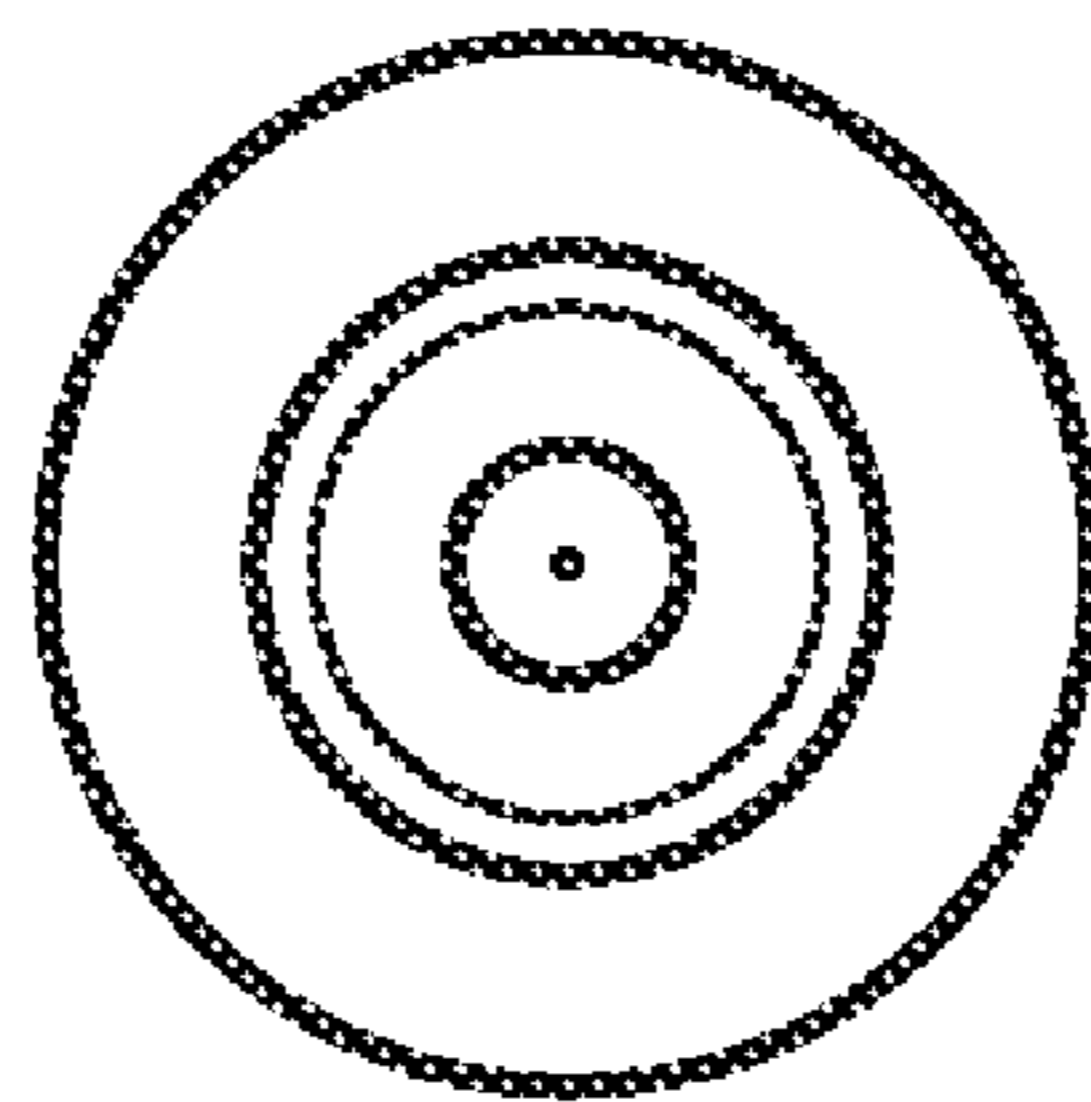

Fig. 28