



US00D612872S

(12) **United States Design Patent**
Baacke et al.

(10) **Patent No.:** **US D612,872 S**
(45) **Date of Patent:** **** *Mar. 30, 2010**

(54) **REFRIGERATOR DRAWER**

(75) Inventors: **Sven Baacke**, Munich (DE); **Christoph Becke**, Stephanskirchen (DE); **Matthew Ricket**, New Bern, NC (US); **Hermann-Reinhard Segers**, Munich (DE); **Roland Vetter**, Giengen (DE)

(73) Assignee: **BSH Bosch und Siemens Hausgeraete GmbH**, Munich (DE)

(*) Notice: This patent is subject to a terminal disclaimer.

(**) Term: **14 Years**

(21) Appl. No.: **29/259,938**

(22) Filed: **May 16, 2006**

(30) **Foreign Application Priority Data**

Nov. 30, 2005 (EM) 000445770

(51) **LOC (9) Cl.** **15-07**

(52) **U.S. Cl.** **D15/89**

(58) **Field of Classification Search** D15/79,
D15/85, 86, 89, 90, 91; 62/3.6, 125, 126,
62/187; 312/116, 138.1, 236, 321.5, 330.1,
312/405.1, 400-408; 211/90.01, 153, 194;
108/26, 59, 108, 147.11, 147.16, 157.13;
220/DIG. 14; D6/512

See application file for complete search history.

(56) **References Cited**

U.S. PATENT DOCUMENTS

D292,516 S * 10/1987 Wolff D15/89

D344,739 S * 3/1994 Edman et al. D15/89
D352,516 S * 11/1994 Newman et al. D24/218
D362,572 S * 9/1995 Joseph, Jr. D6/511
D377,028 S * 12/1996 Monday D15/90
D490,091 S * 5/2004 Quinlan D15/89
D511,177 S * 11/2005 Jackovin et al. D15/89
D511,179 S * 11/2005 Tunzi D15/89
D522,542 S * 6/2006 Czach et al. D15/89

* cited by examiner

Primary Examiner—Stella M Reid

Assistant Examiner—Shanda C Hill

(74) *Attorney, Agent, or Firm*—James E. Howard; Andre Pallabies

(57) **CLAIM**

The ornamental design for a refrigerator drawer, as shown.

DESCRIPTION

FIG. 1 is a perspective view of a refrigerator drawer showing our ornamental design;

FIG. 2 is a front elevational view thereof;

FIG. 3 is a top plan thereof;

FIG. 4 is a right side elevational view thereof;

FIG. 5 is a left side elevational view thereof;

FIG. 6 is a bottom plan view thereof; and,

FIG. 7 is a rear elevational view thereof.

1 Claim, 7 Drawing Sheets

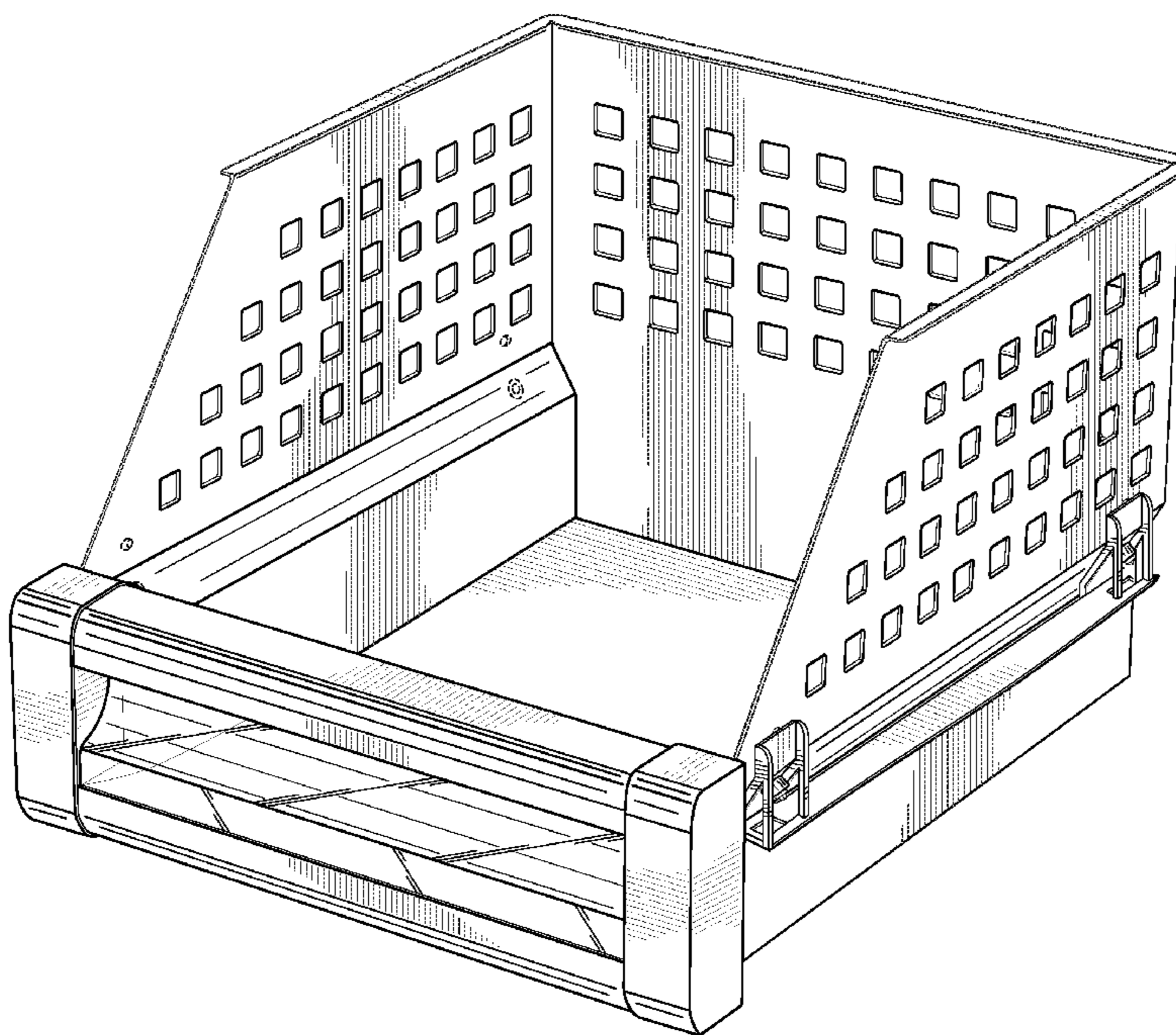

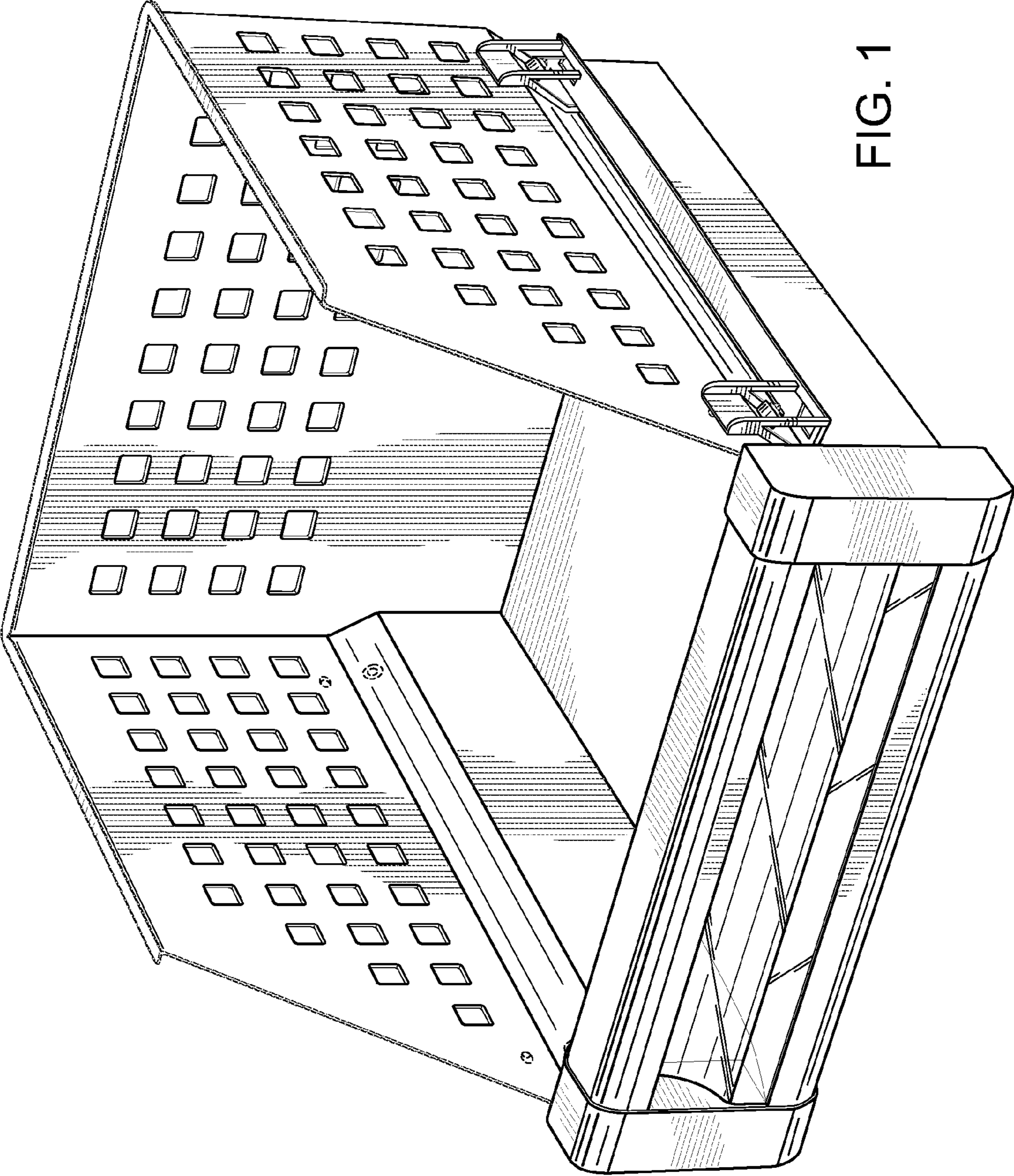

FIG. 1

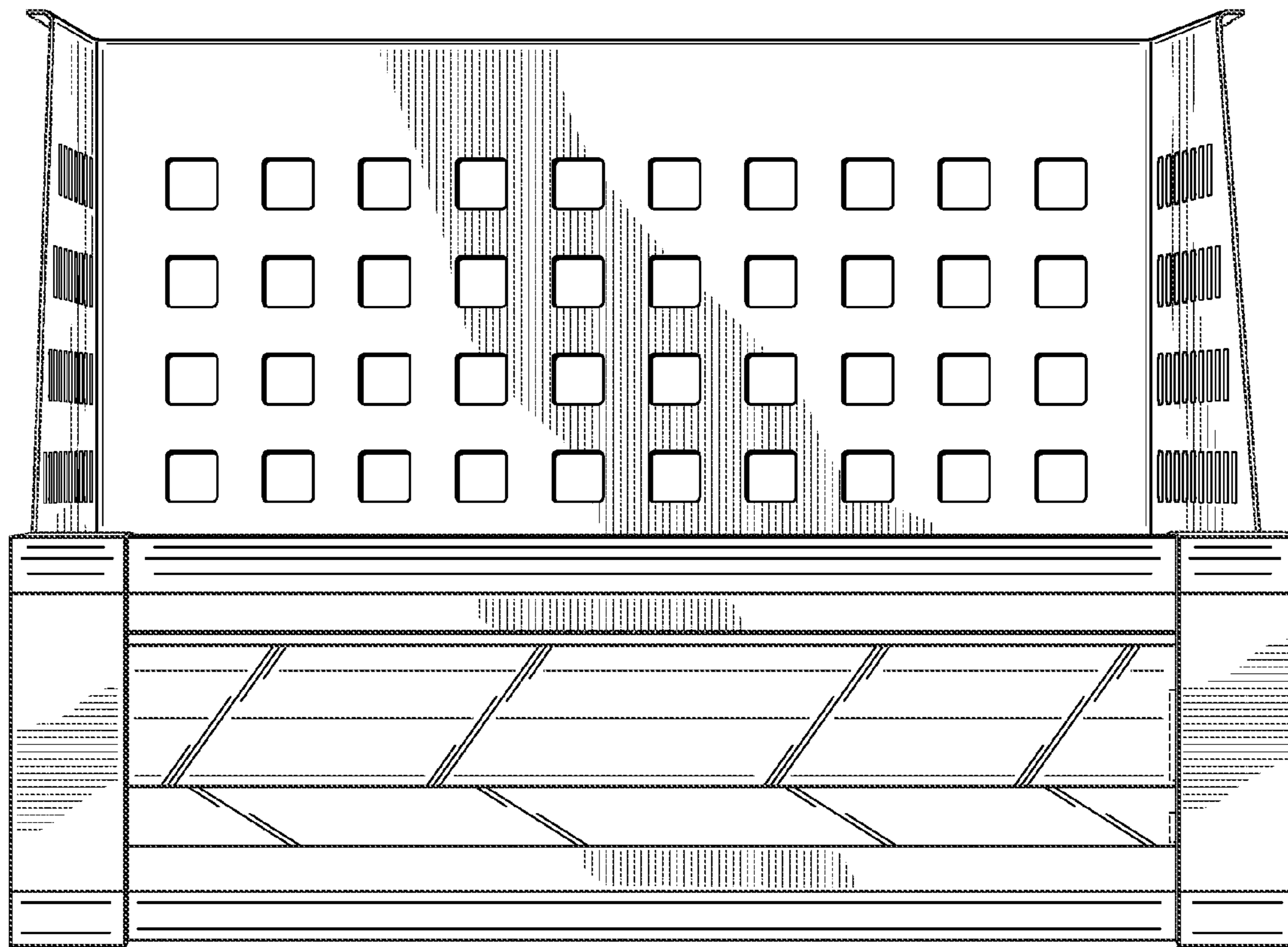

FIG. 2

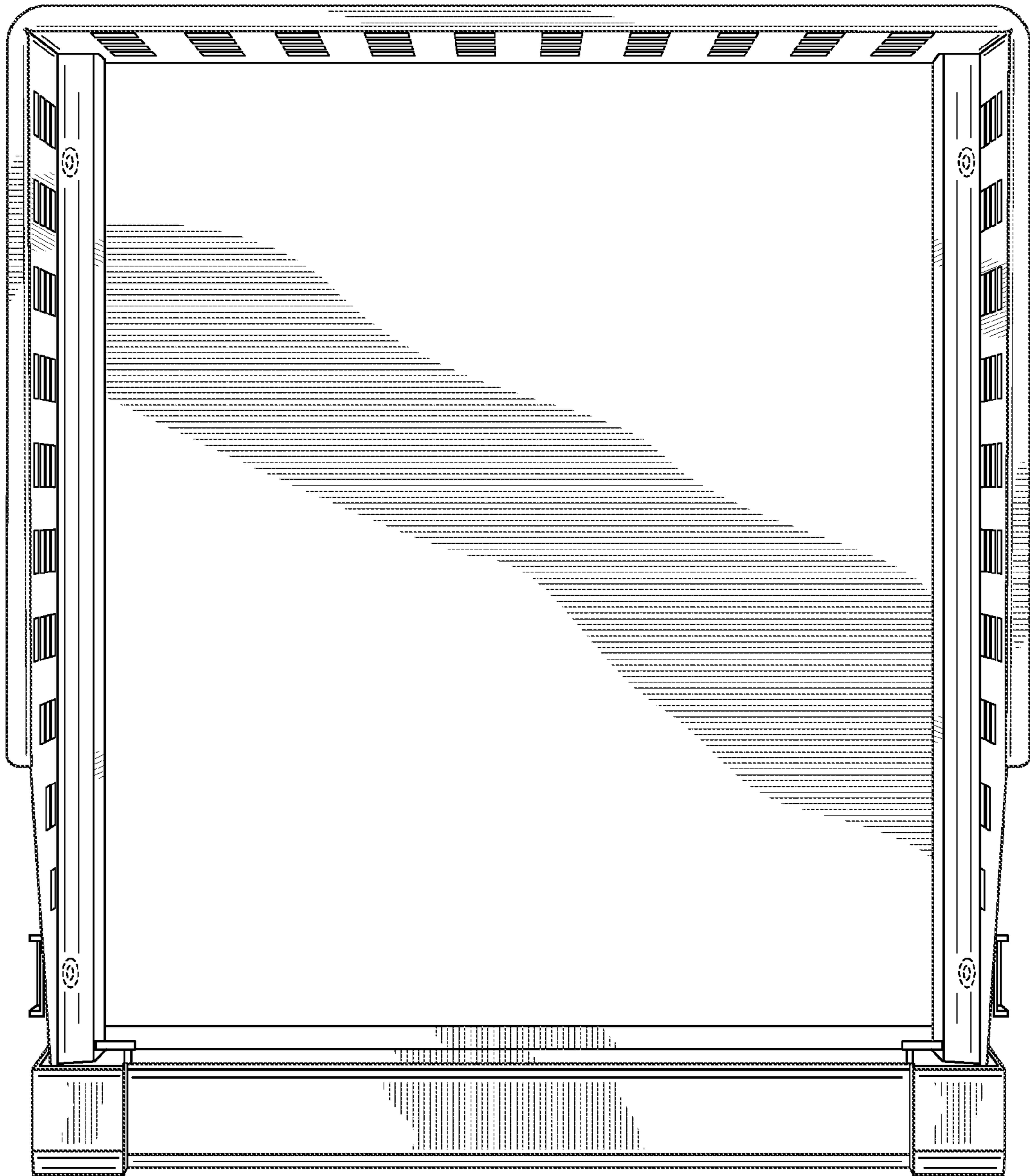

FIG. 3

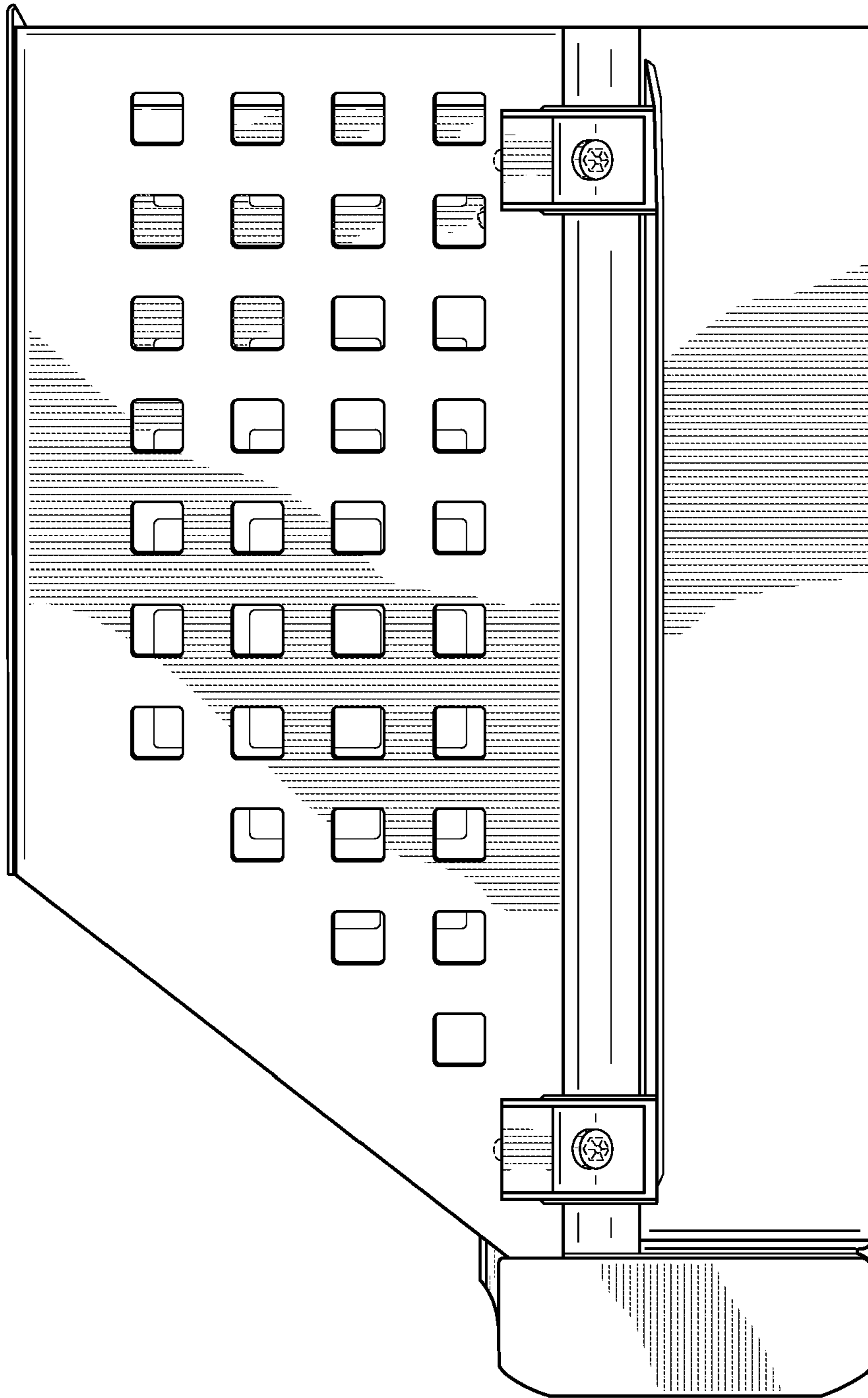

FIG. 4

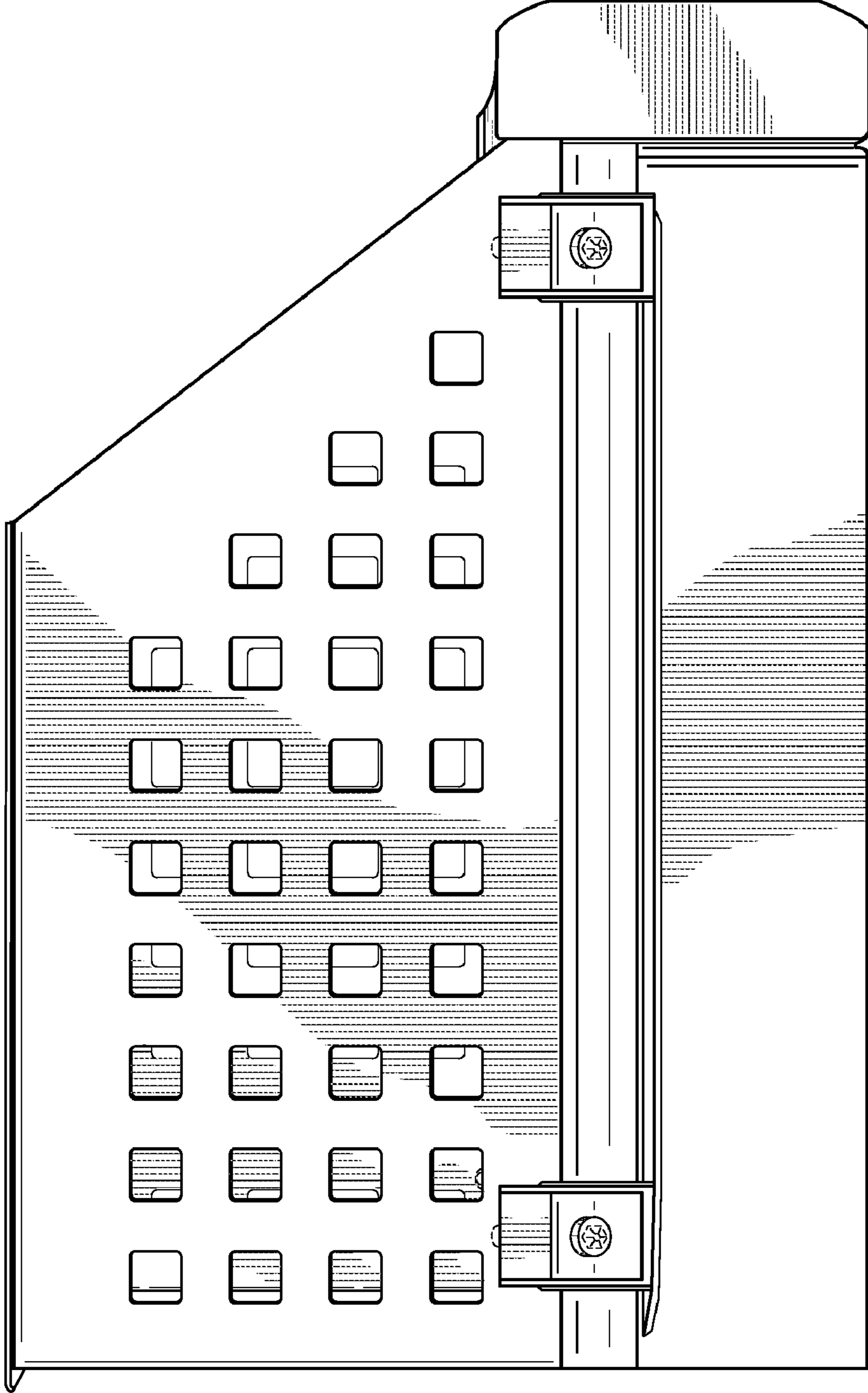

FIG. 5

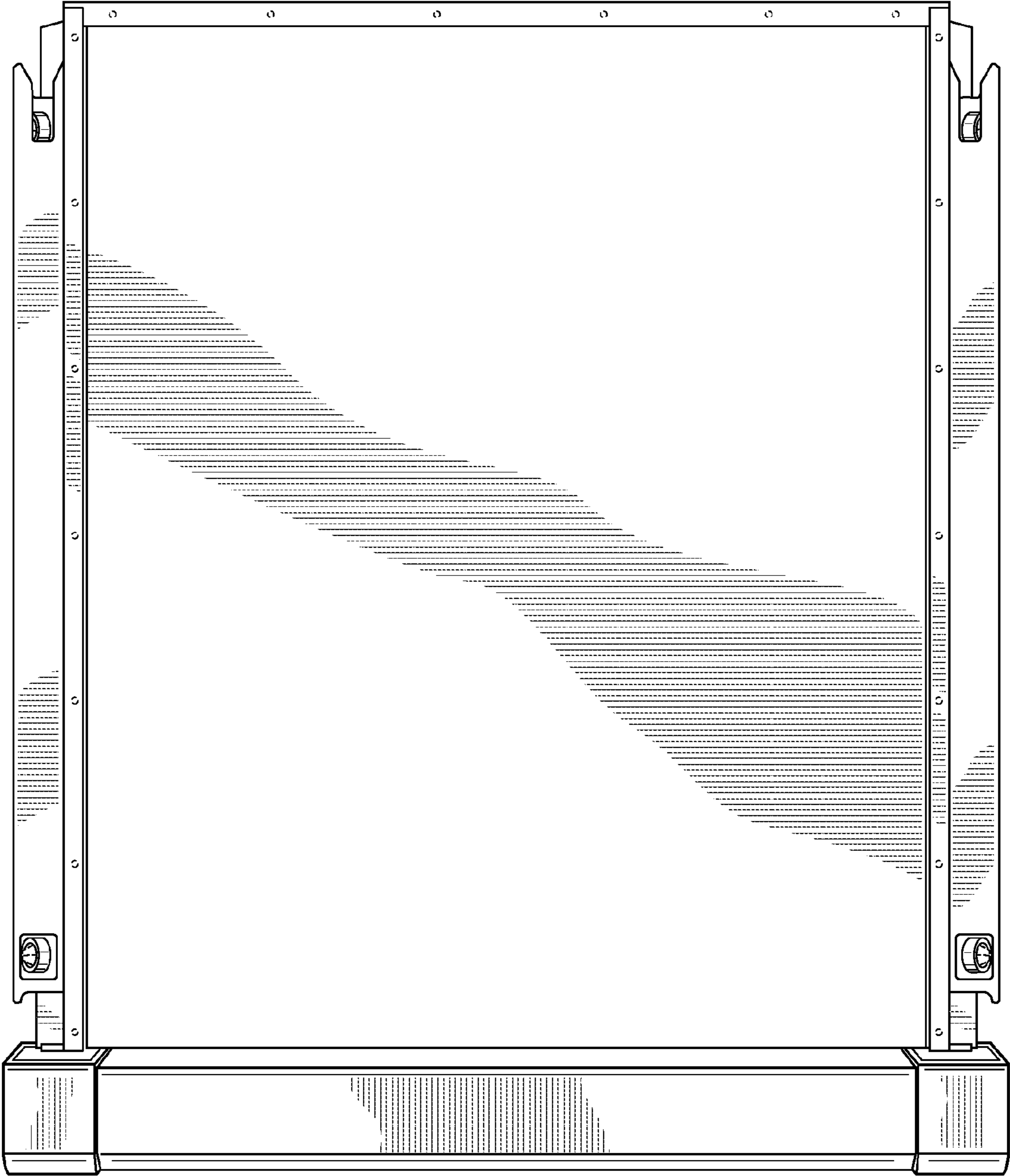

FIG. 6

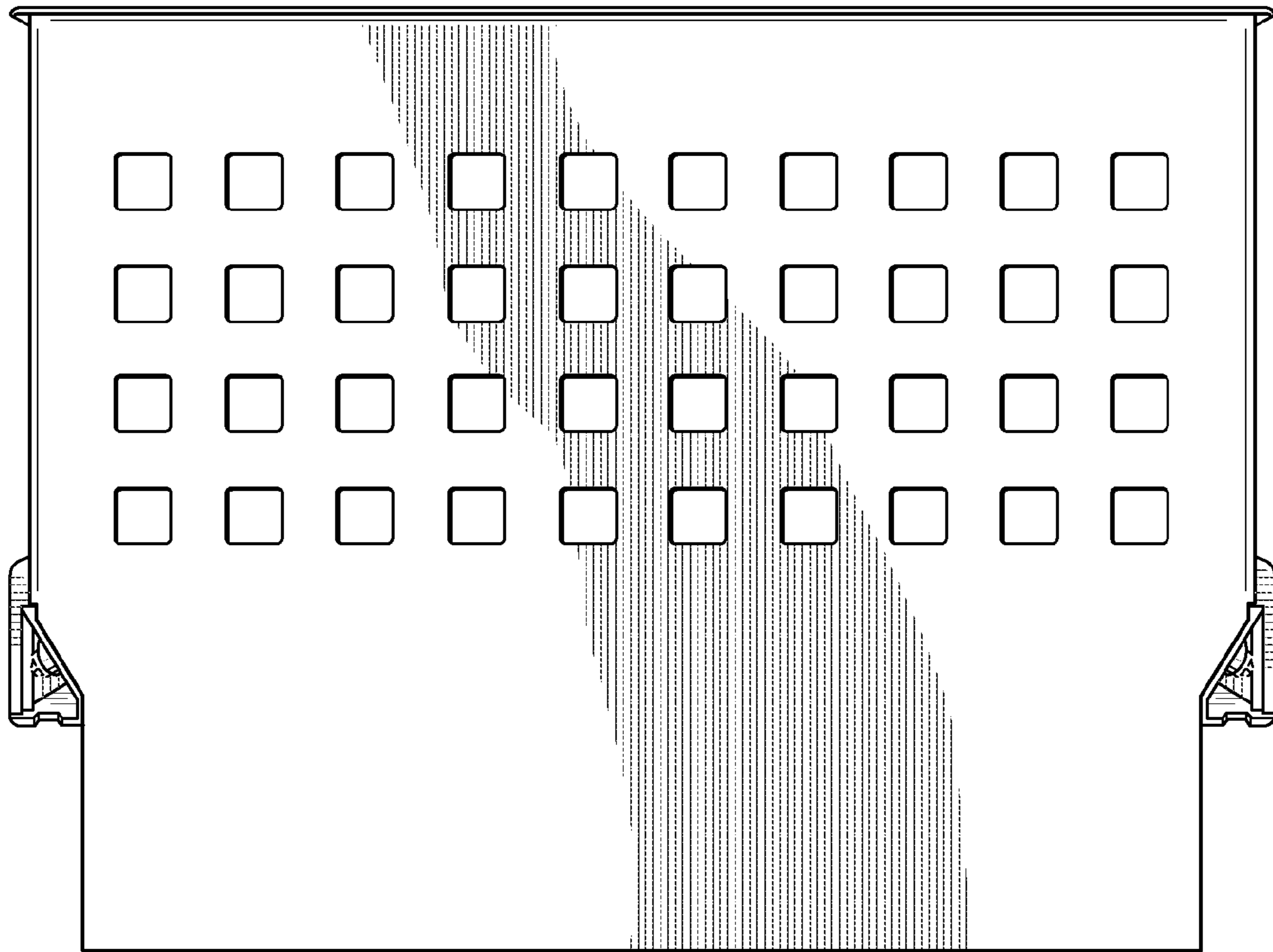

FIG. 7