



US00D612854S

(12) **United States Design Patent**
Arnold et al.

(10) **Patent No.:** **US D612,854 S**
(45) **Date of Patent:** **** Mar. 30, 2010**

(54) **HAND HELD SCANNER**

(76) Inventors: **Kevin Arnold**, 2210 Hutton Dr., Dallas, TX (US) 75006; **Paul Billings**, 2210 Hutton Dr., Dallas, TX (US) 75006; **Cantor Graves**, 2210 Hutton Dr., Dallas, TX (US) 75006

(**) Term: **14 Years**

(21) Appl. No.: **29/315,117**

(22) Filed: **May 27, 2009**

(51) **LOC (9) Cl.** **14-02**

(52) **U.S. Cl.** **D14/429**

(58) **Field of Classification Search** D14/420, D14/426-430, 453, 346, 341, 347, 412; D13/107, D13/184; 358/473; 235/462.43, 462.45, 235/462.47, 462.48, 462.44, 462.46, 487, 235/472.01, 472.02; 16/110.1, 430, 431; 709/219, 201; 710/73; 320/114, 115, 123; 361/679; 382/313, 321; 455/575.1, 561, 455/572

See application file for complete search history.

(56) **References Cited**

U.S. PATENT DOCUMENTS

D334,922	S	*	4/1993	Meyerson et al.	D14/429
5,736,726	A	*	4/1998	VanHorn et al.	235/472.02
5,818,027	A	*	10/1998	Paratore	235/472.01
D414,760	S	*	10/1999	Hetfield et al.	D14/426
5,996,896	A	*	12/1999	Grabon	235/472.02
6,031,524	A	*	2/2000	Kunert	345/173
D463,425	S	*	9/2002	Jenkins	D14/347
6,633,483	B2	*	10/2003	Akagi et al.	361/679.4
D494,593	S	*	8/2004	Wulff et al.	D14/429
D496,366	S	*	9/2004	Croley et al.	D14/429
6,822,853	B2	*	11/2004	Wulff et al.	361/679.08

D512,427	S	*	12/2005	Choi et al.	D14/428
D539,294	S	*	3/2007	Croley et al.	D14/453
7,195,168	B2	*	3/2007	Wulff	235/462.45
7,195,169	B2	*	3/2007	Bhatia et al.	235/472.01
7,347,375	B2	*	3/2008	Durbin	235/462.45
D571,808	S	*	6/2008	Dorr et al.	D14/429
7,416,129	B2	*	8/2008	Bhatia et al.	235/472.01
2004/0089722	A1	*	5/2004	Durbin	235/472.01
2005/0017078	A1	*	1/2005	Bhatia et al.	235/462.45
2007/0158429	A1	*	7/2007	Bhatia et al.	235/462.45
2009/0224039	A1	*	9/2009	Hause et al.	235/385

* cited by examiner

Primary Examiner—Susan Moon Lee

(74) *Attorney, Agent, or Firm*—Thrasher Associates

(57) **CLAIM**

We claim the ornamental design for a hand held scanner, as shown and described.

DESCRIPTION

FIG. 1 is a perspective view of a hand held scanner showing our new design;

FIG. 2 is a rear view thereof;

FIG. 3 is a top view thereof;

FIG. 4 is a bottom view thereof;

FIG. 5 is a front view thereof;

FIG. 6 is a first side view thereof; and,

FIG. 7 is a second side view thereof.

The portions shown in broken line and the spaces therein encompassed within are not claimed. Furthermore, any instance where there is a singular broken line shown, such as along the handle and left and right sides of the scanner body, such singular broken lines are not claimed.

1 Claim, 7 Drawing Sheets

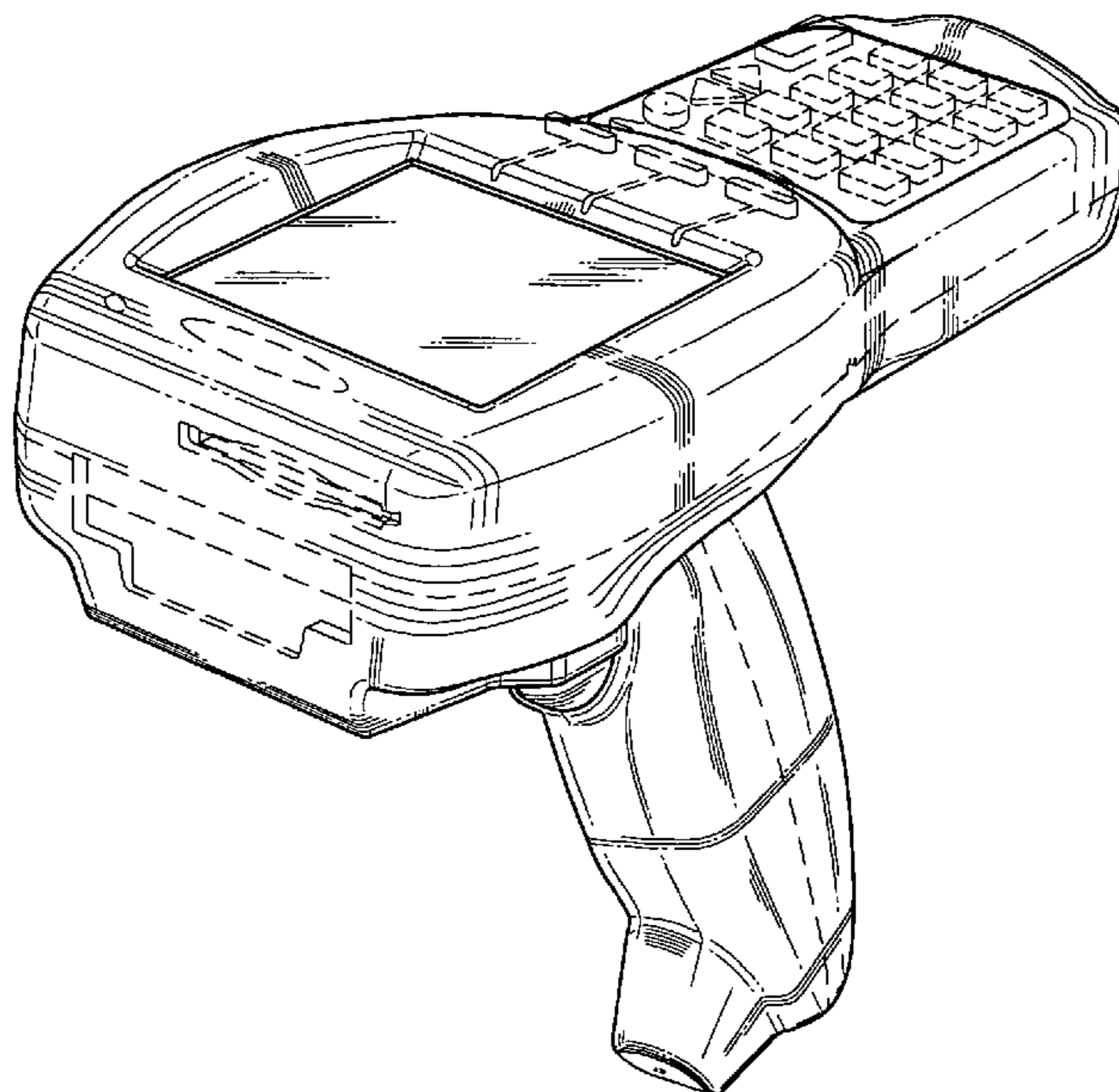

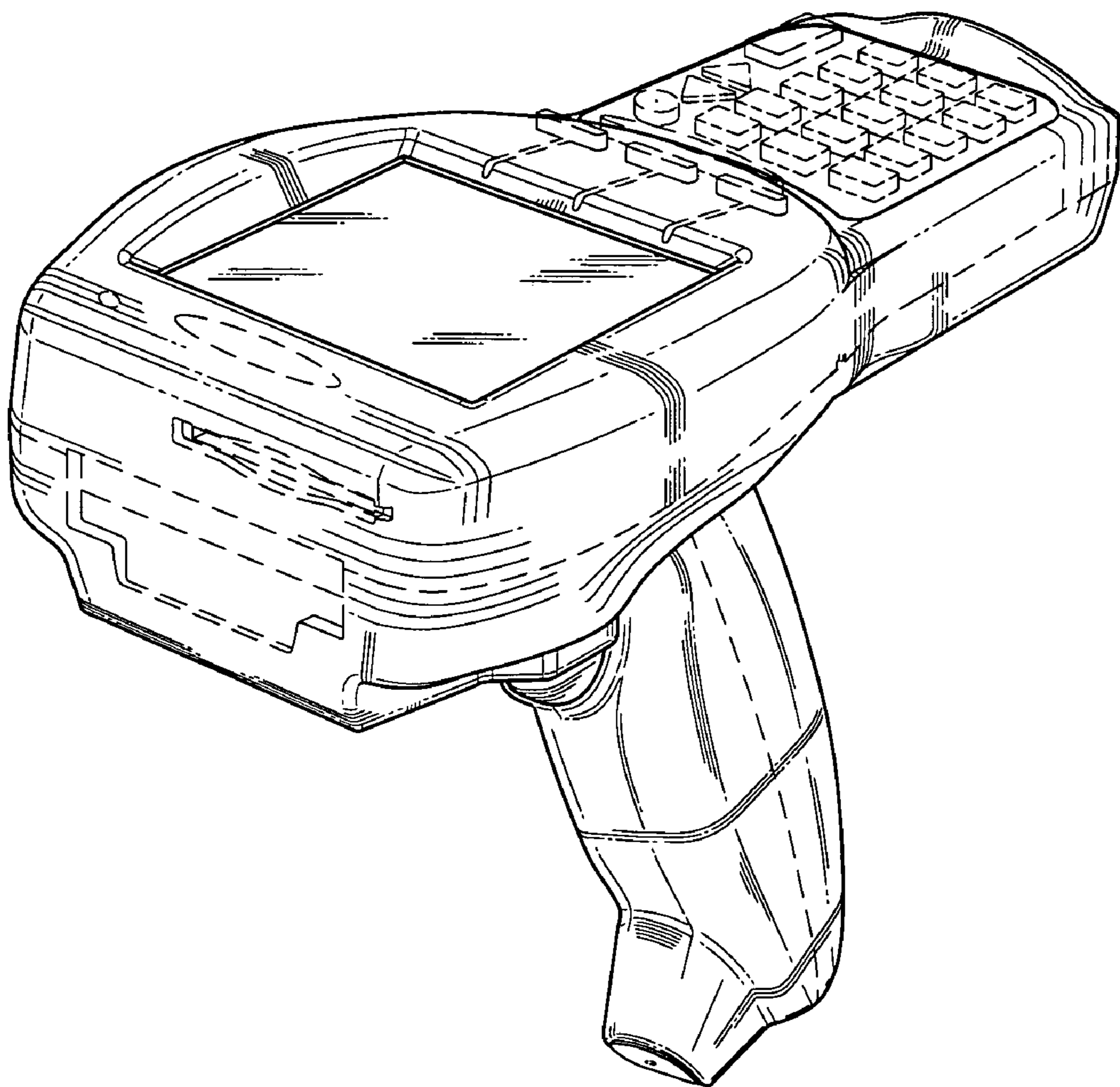

FIG 1

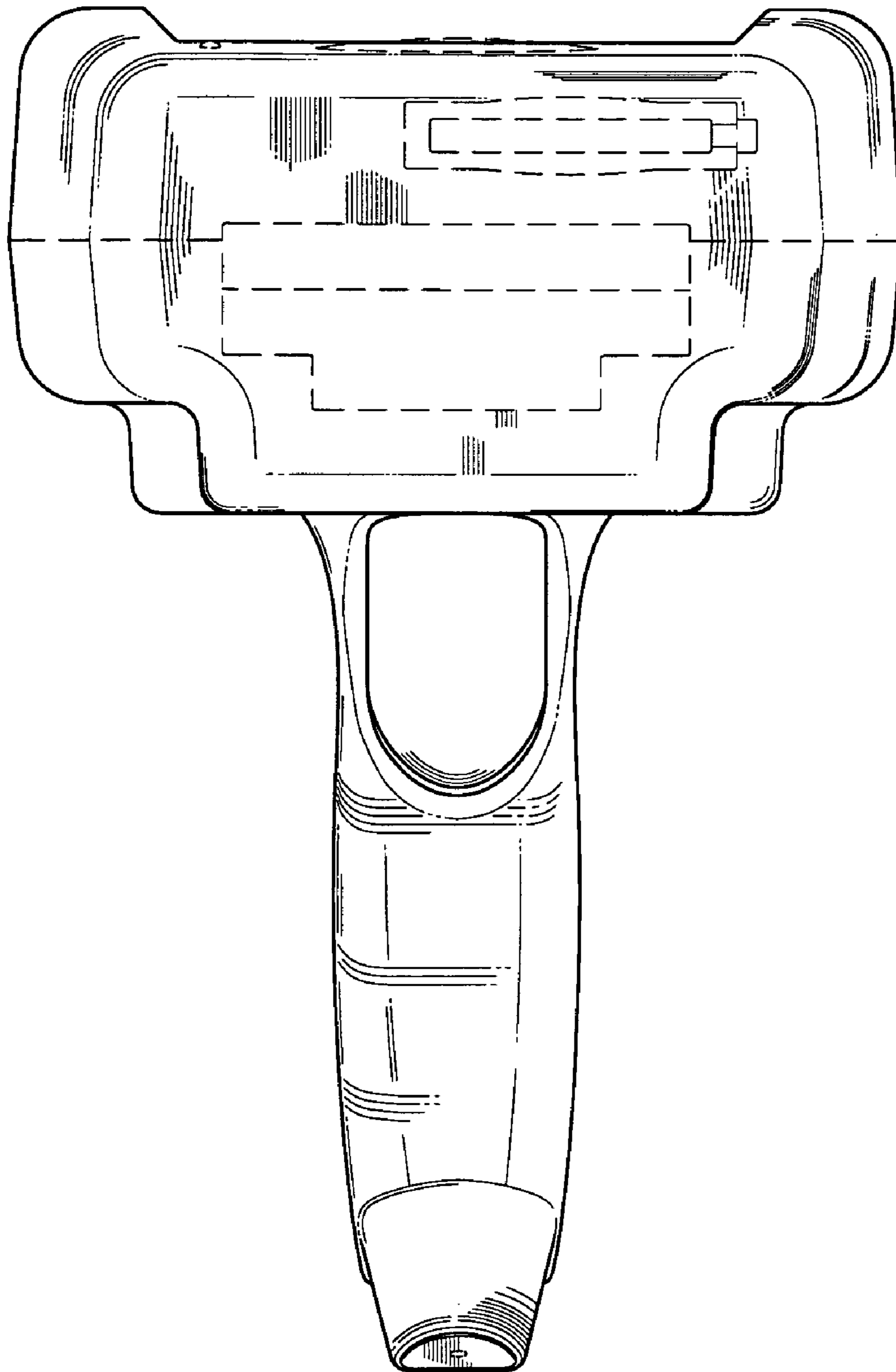

FIG 2

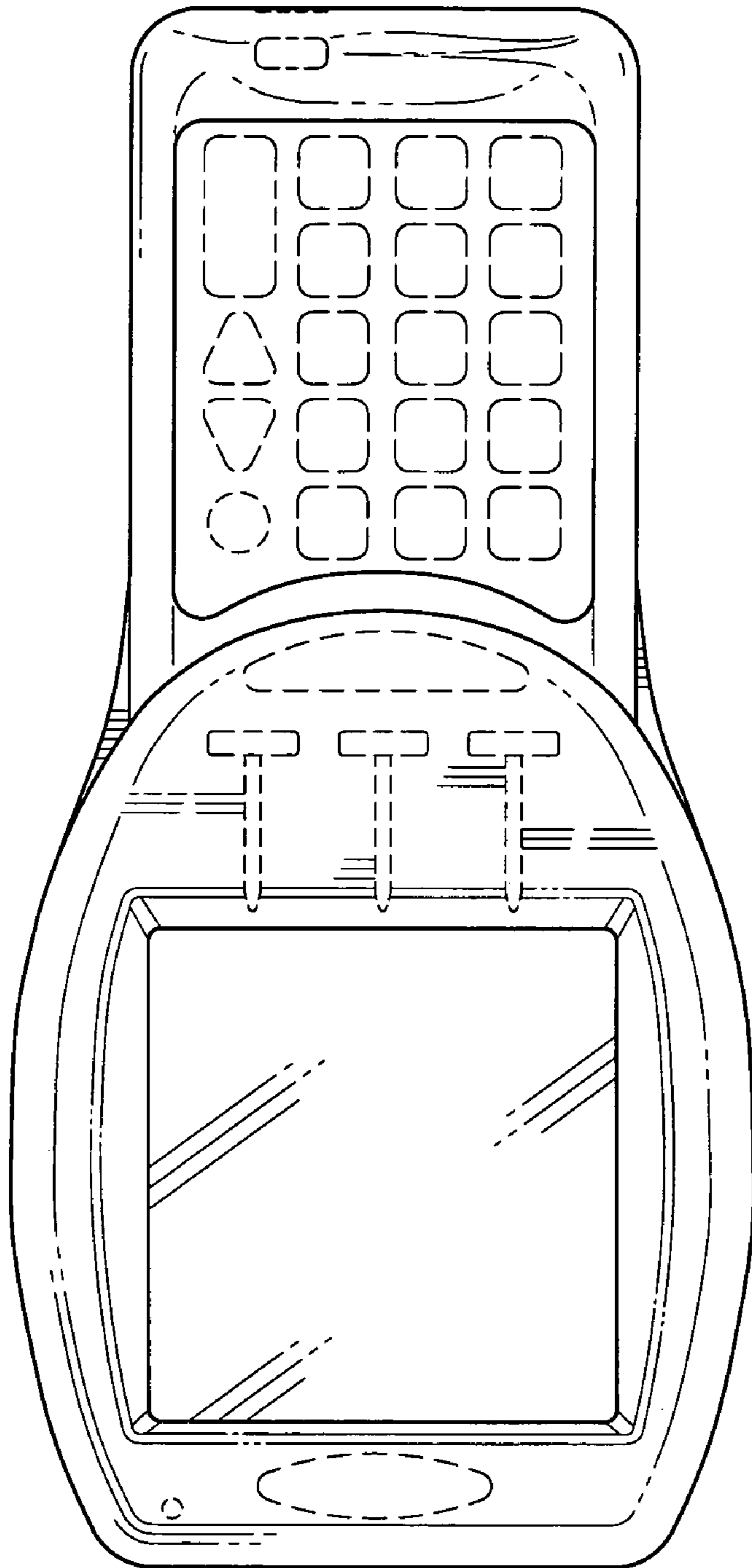

FIG 3

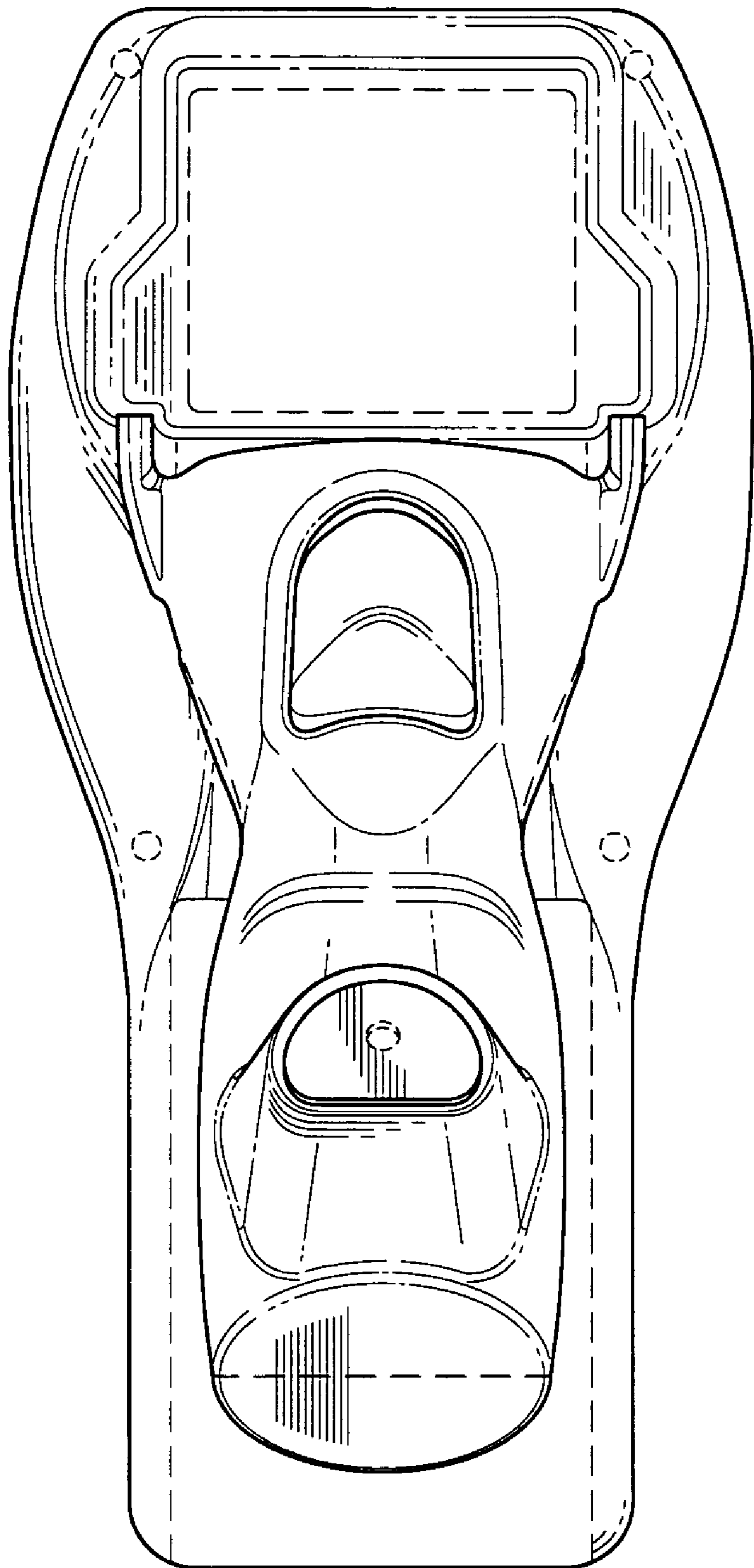

FIG 4

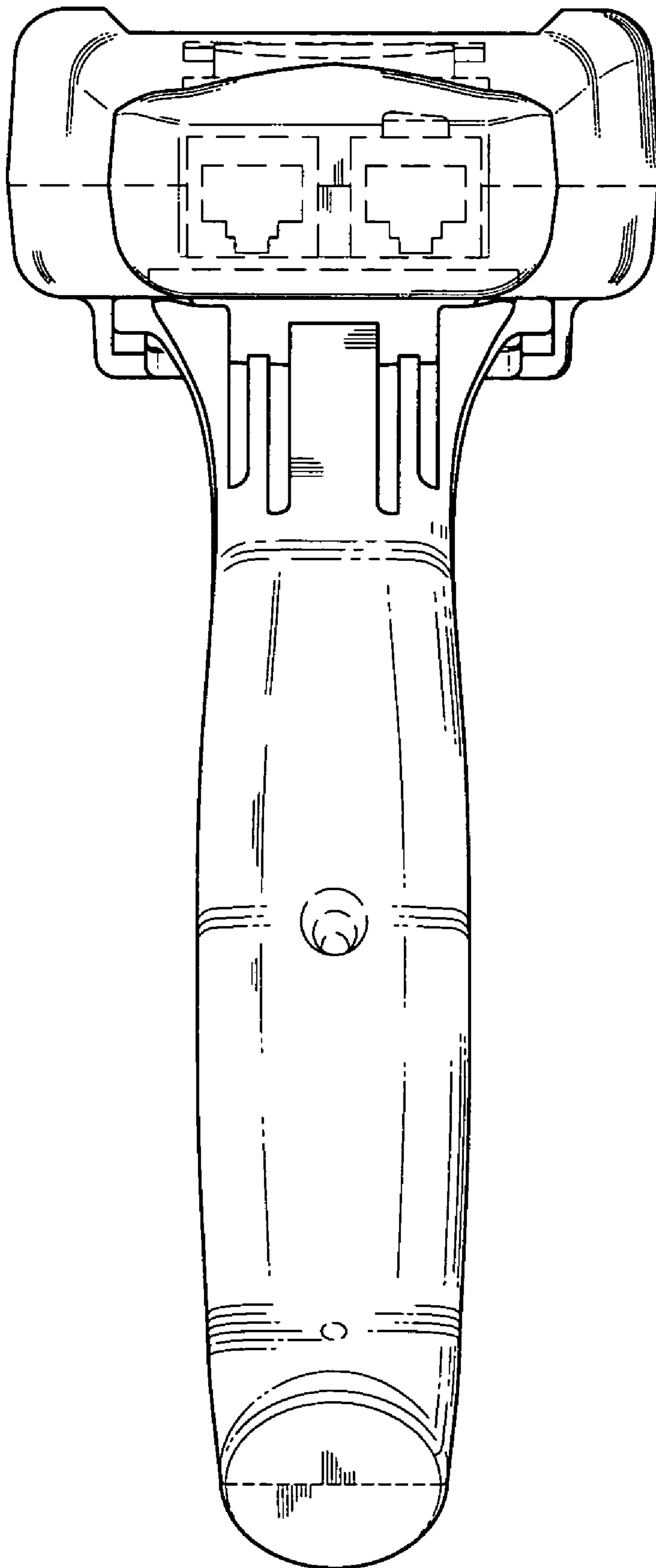

FIG 5

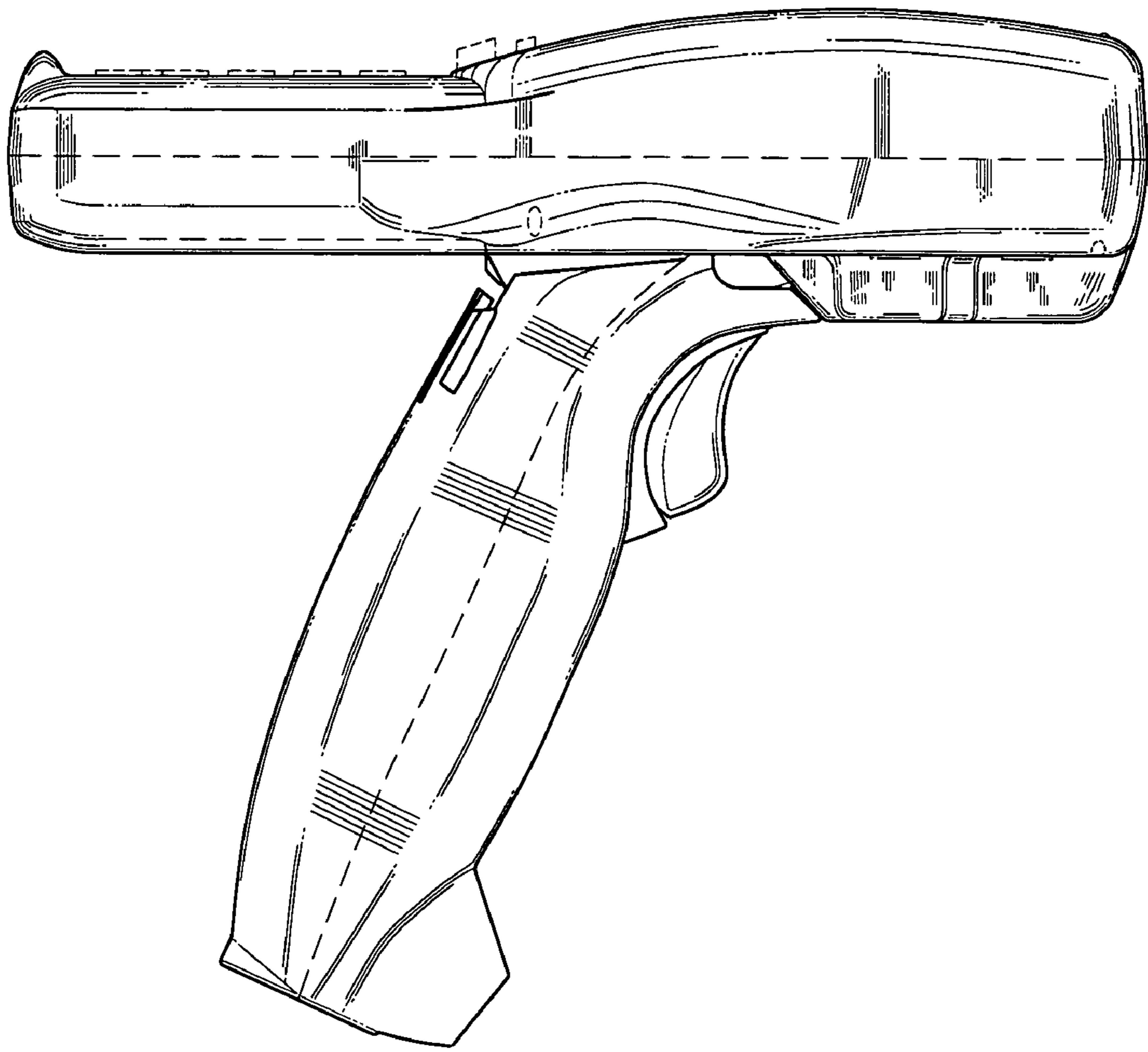

FIG 6

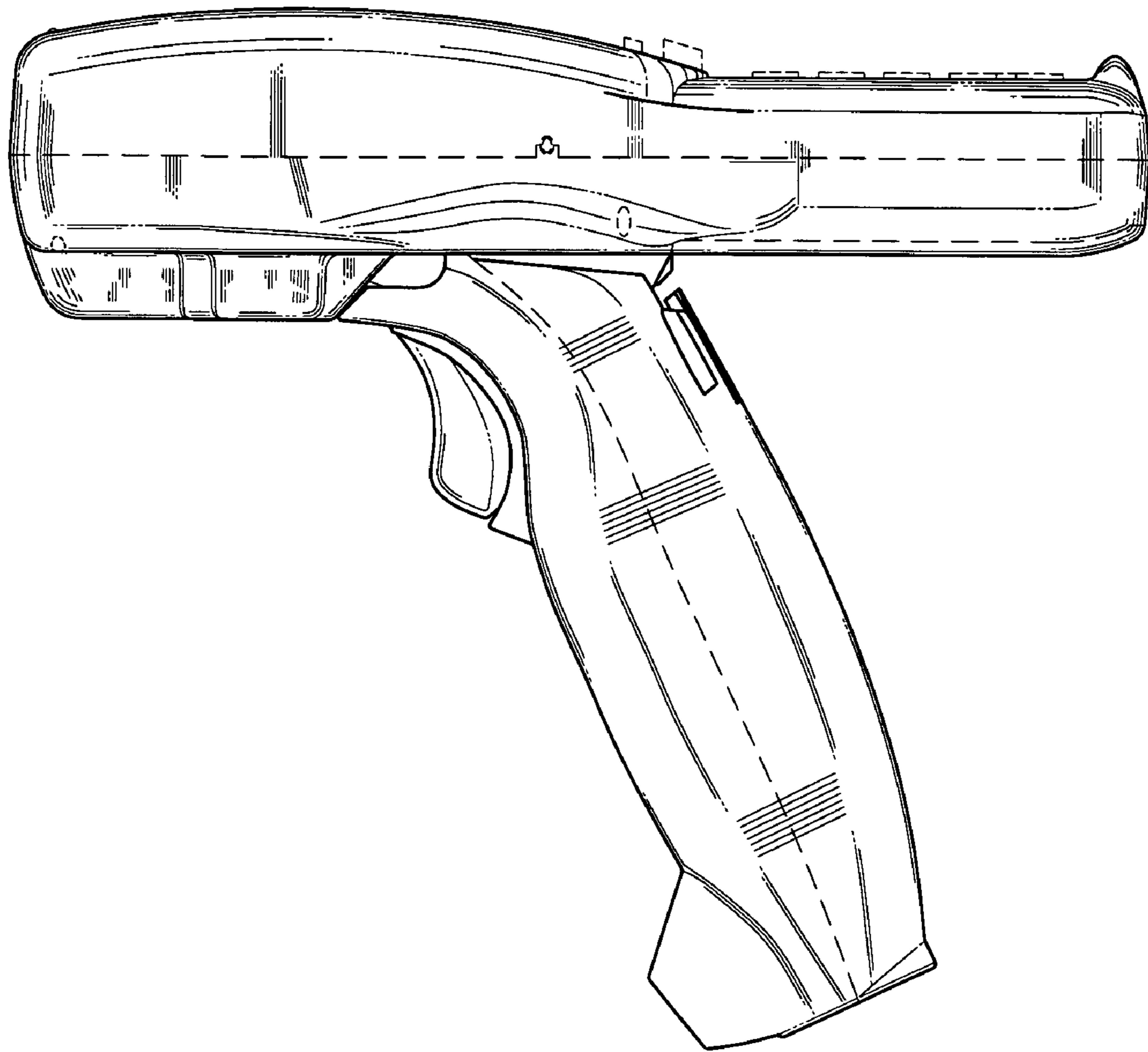

FIG 7