



US00D612850S

(12) **United States Design Patent**
Cabatic

(10) **Patent No.:** **US D612,850 S**
(45) **Date of Patent:** **** Mar. 30, 2010**

(54) **HANDHELD AUDIENCE RESPONSE DEVICE**

(75) Inventor: **Bryan Cabatic**, Shoreline, WA (US)

(73) Assignee: **Qwizdom, Inc.**, Puyallup, WA (US)

(**) Term: **14 Years**

(21) Appl. No.: **29/298,390**

(22) Filed: **Dec. 4, 2007**

(51) **LOC (9) Cl.** **14-02**

(52) **U.S. Cl.** **D14/388**; D14/218; D13/168

(58) **Field of Classification Search** D14/341–347,
D14/356–358, 388–390, 426, 432, 439–446,
D14/453, 496, 138 R, 138 AA, 138 AB, 138 AC,
D14/138 AD, 138 C, 138 G, 217, 238.1,
D14/240, 257, 299, 218; 455/556.1, 566,
455/575.1, 575.3, 575.4; 345/169; D13/168
See application file for complete search history.

(56) **References Cited**

U.S. PATENT DOCUMENTS

D403,667 S *	1/1999	Musha	D14/347
D410,909 S *	6/1999	Tickle	D14/388
D425,518 S *	5/2000	Simms	D14/347
D428,412 S *	7/2000	Davis	D14/341
D433,416 S *	11/2000	Strand et al.	D14/426
D441,733 S *	5/2001	Do et al.	D14/138 AA
D453,503 S *	2/2002	Fitzsimmons et al.	D13/168
D479,516 S *	9/2003	Bricaud et al.	D14/138 AA
D503,709 S *	4/2005	Lodato et al.	D14/341
D517,531 S *	3/2006	Lai	D14/218
D518,043 S *	3/2006	Barness et al.	D14/346
D525,947 S *	8/2006	Gerard et al.	D13/168
D535,654 S *	1/2007	Beamish et al.	D14/388
D542,792 S *	5/2007	Beamish et al.	D14/388
D552,606 S *	10/2007	Swanson	D14/346
D565,554 S *	4/2008	Fan	D14/218

D569,867 S *	5/2008	Disch et al.	D14/426
D573,981 S *	7/2008	Hoehn et al.	D14/218
D574,830 S *	8/2008	Tasselli et al.	D14/426
D576,959 S *	9/2008	Aldape et al.	D13/168
D576,960 S *	9/2008	Aldape et al.	D13/168

* cited by examiner

Primary Examiner—Cathron C Brooks

Assistant Examiner—Deanna Fluegeman

(74) *Attorney, Agent, or Firm*—DWC Law Firm, P.S.

(57) **CLAIM**

The ornamental design for a handheld audience response device, as shown and described.

DESCRIPTION

FIG. 1 is a front plan view of a handheld audience response device.

FIG. 2 is a back plan view of the handheld audience response device in FIG. 1.

FIG. 3 is a left-side elevational view of the handheld audience response device in FIG. 1.

FIG. 4 is a right-side elevational view of the handheld audience response device in FIG. 1.

FIG. 5 is a front perspective view of the handheld audience response device in FIG. 1.

FIG. 6 is a back perspective view of the handheld audience response device in FIG. 1.

FIG. 7 is a top-end elevational view of the handheld audience response device in FIG. 1; and,

FIG. 8 is a bottom-end elevational view of the handheld audience response device in FIG. 1.

The broken lines are for illustrative purposes only and form no part of the claimed design.

1 Claim, 6 Drawing Sheets

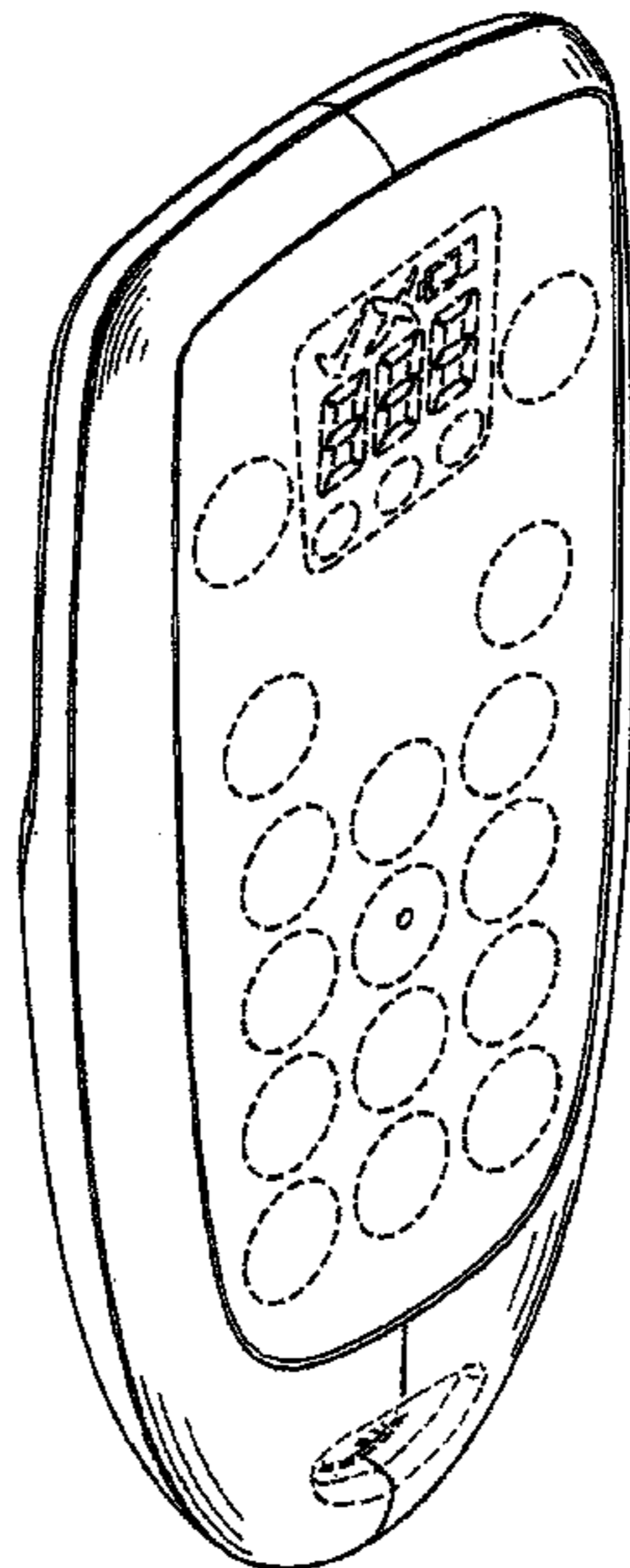

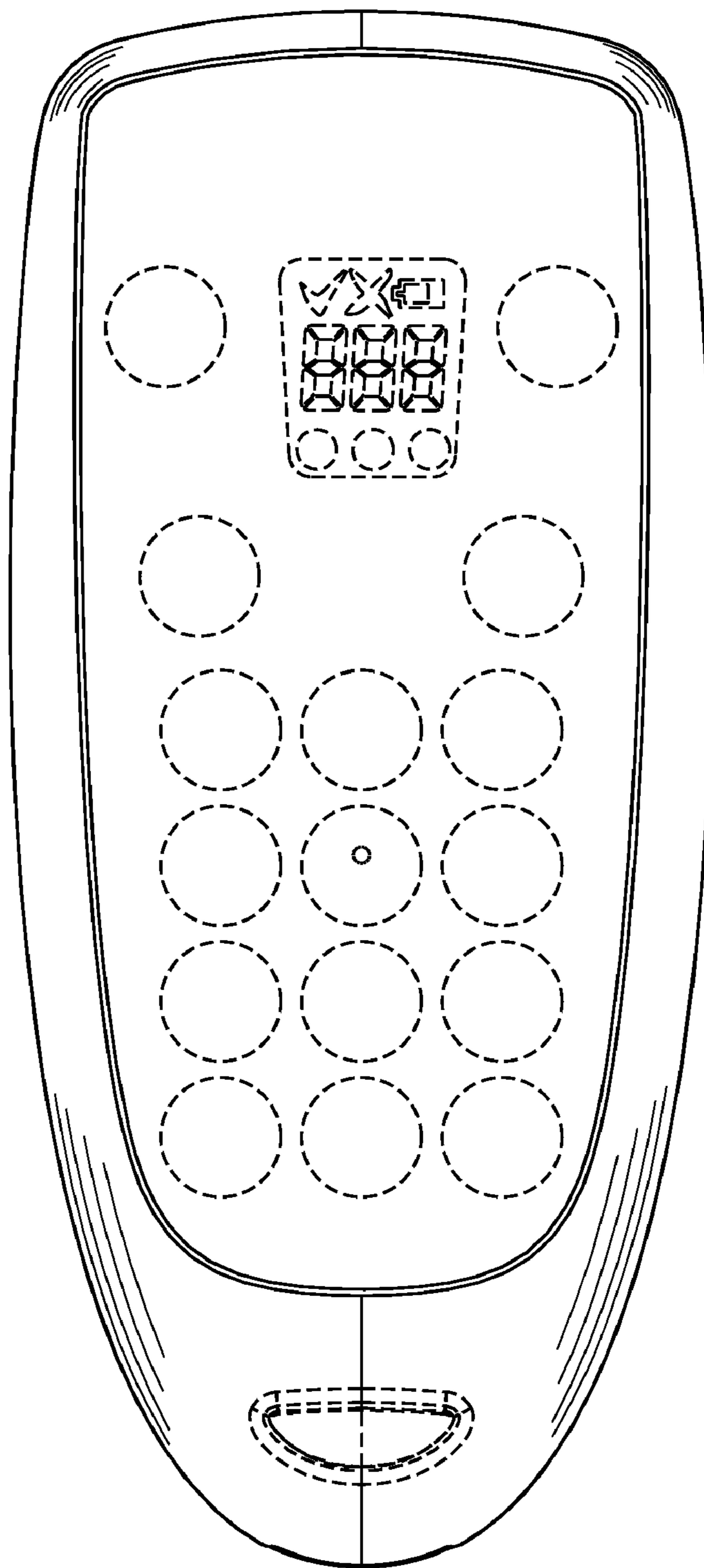

FIG. 1

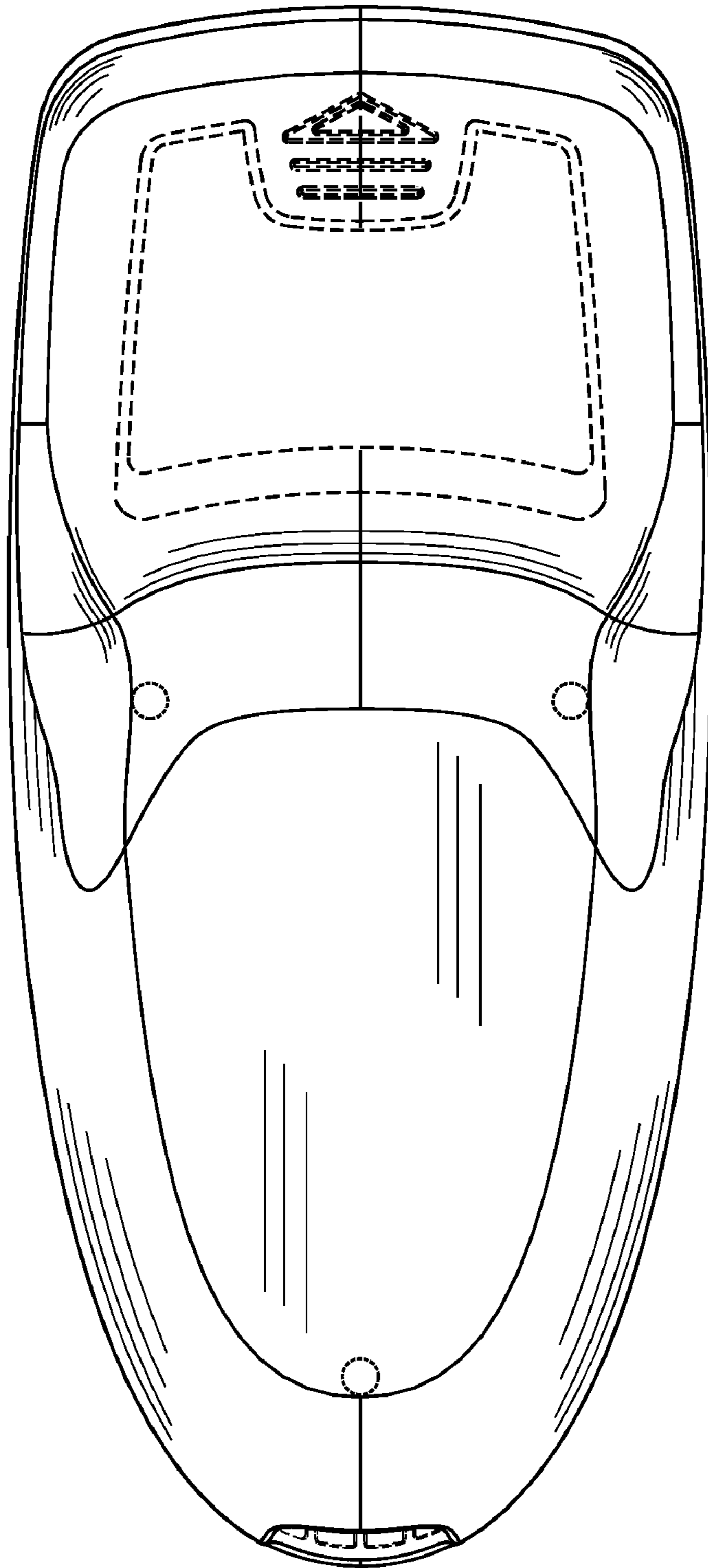

FIG. 2

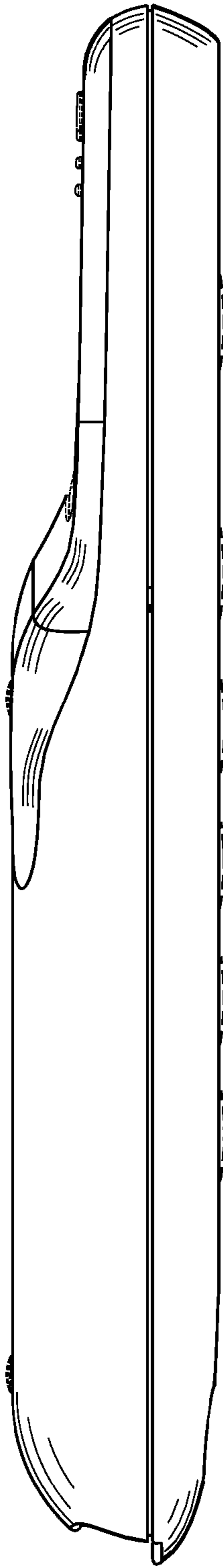

FIG. 3

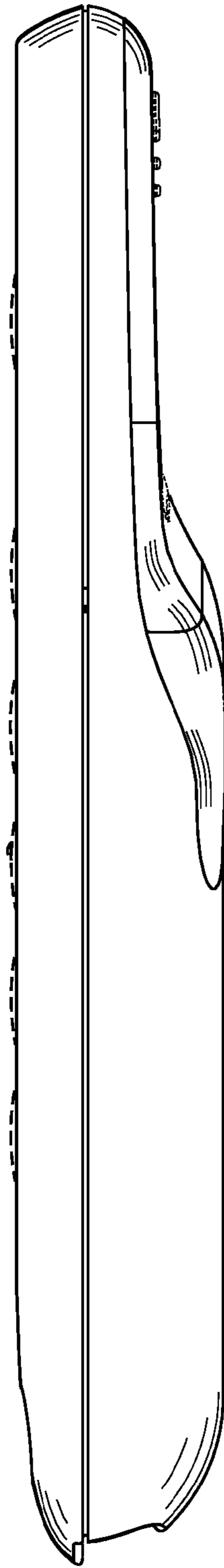

FIG. 4

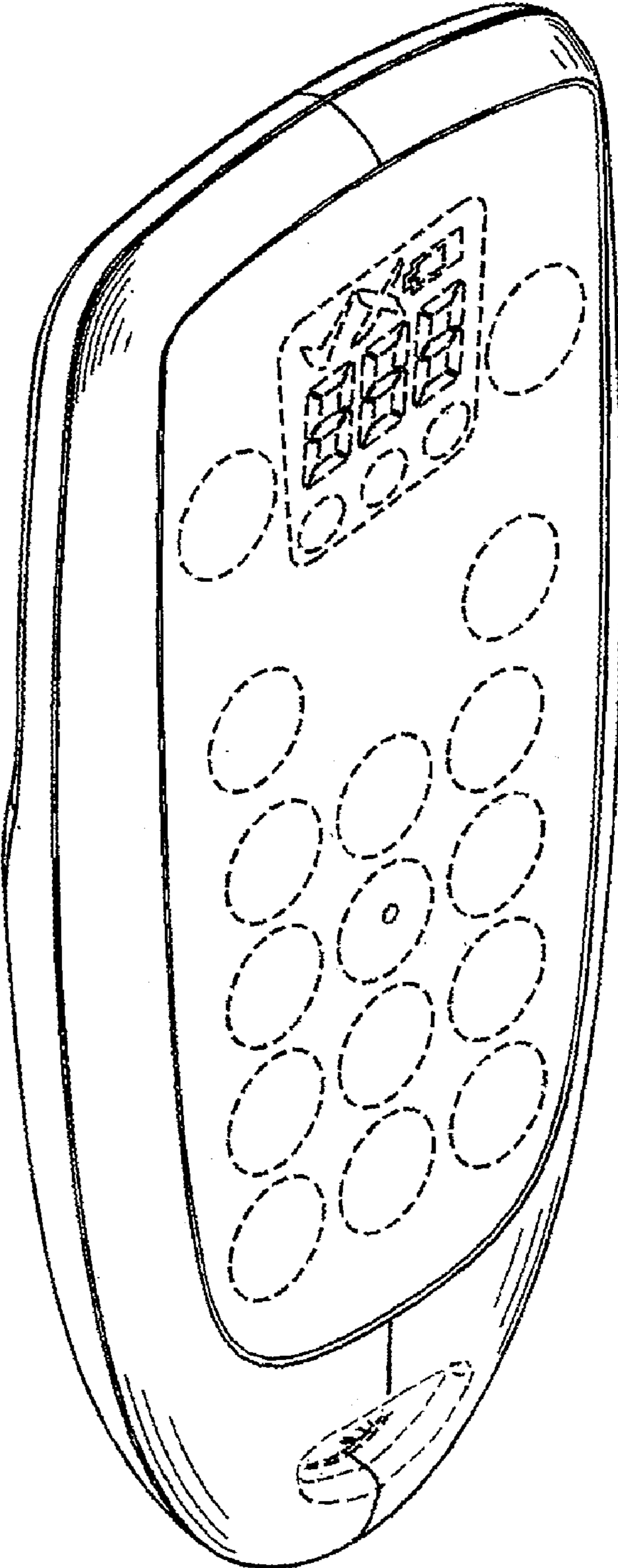

FIG. 5

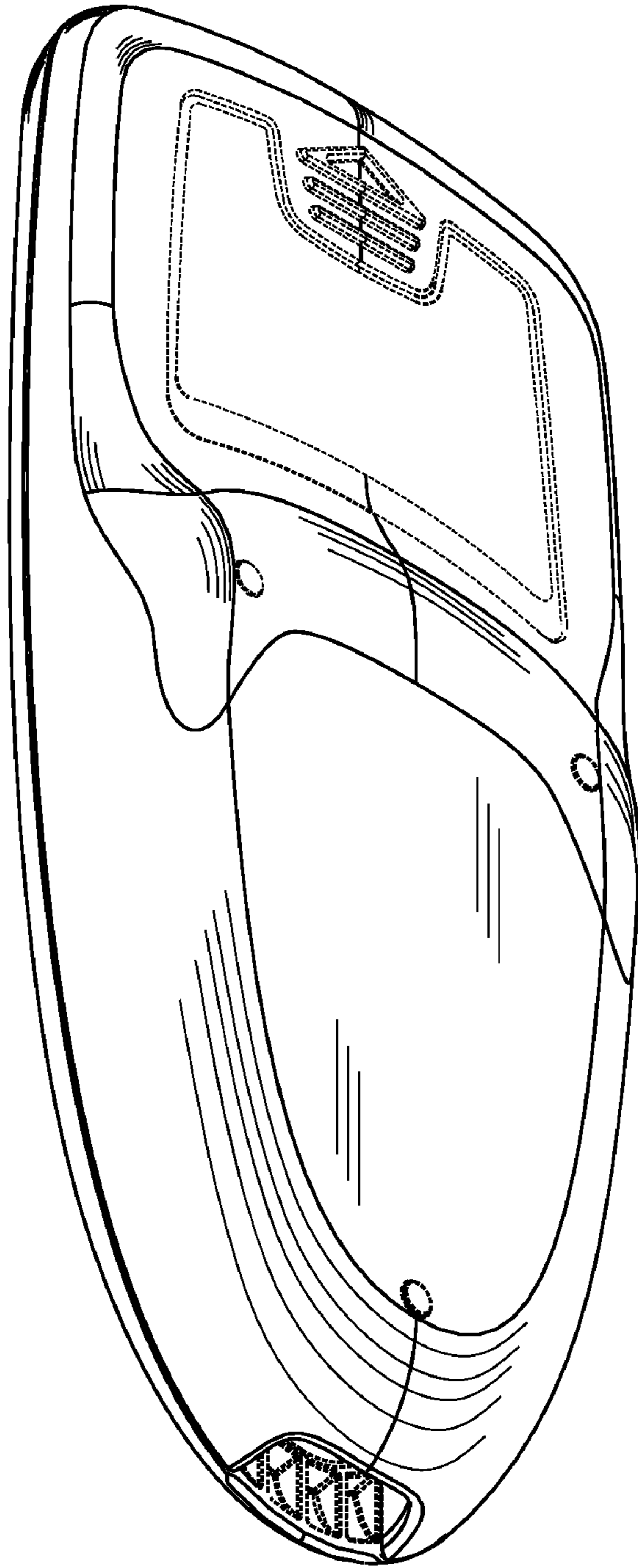

FIG. 6

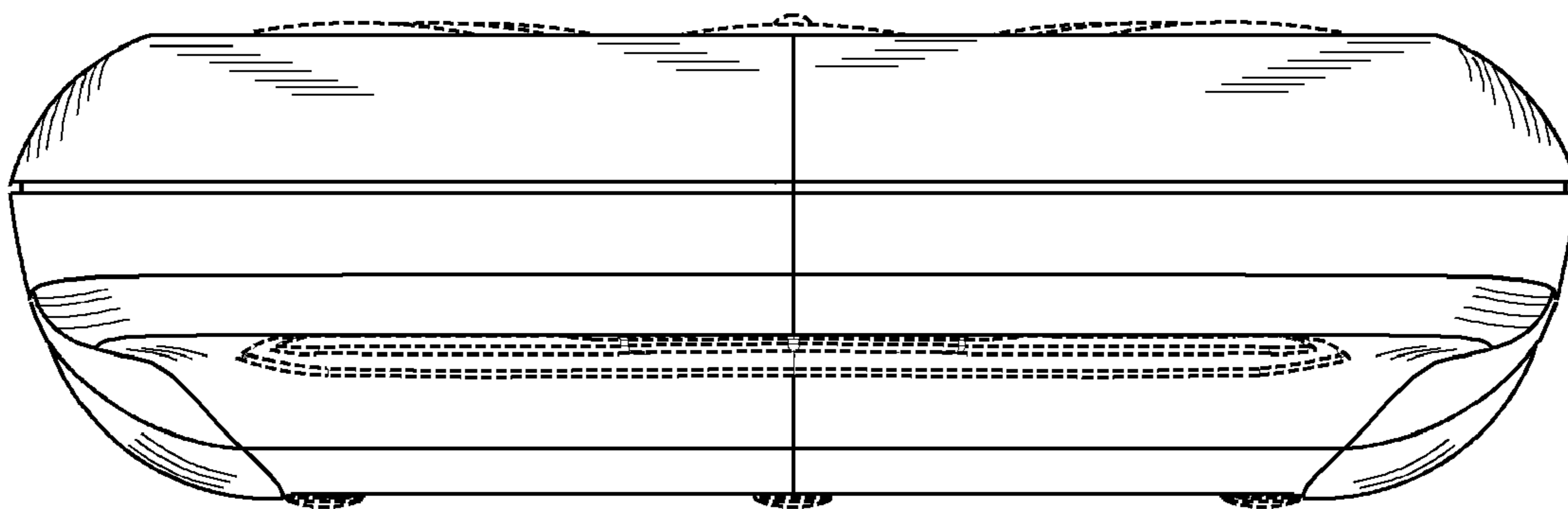

FIG. 7

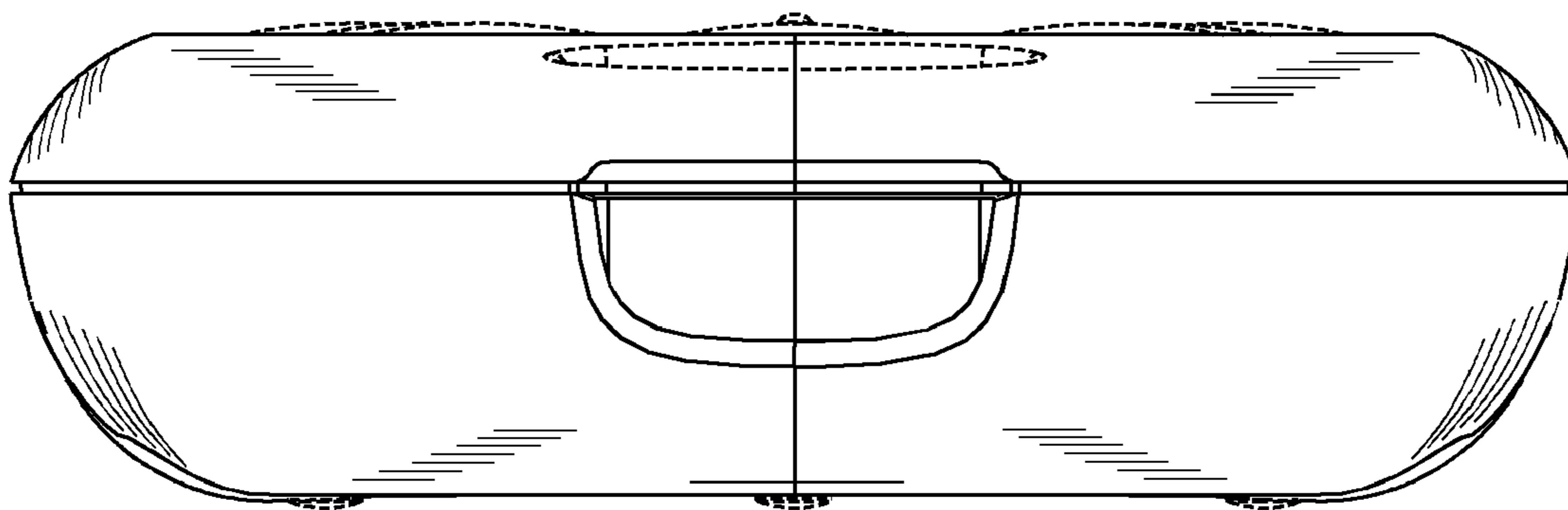

FIG. 8