



US00D612824S

(12) **United States Design Patent**  
**Kim et al.**

(10) **Patent No.:** **US D612,824 S**

(45) **Date of Patent:** **\*\* \*Mar. 30, 2010**

(54) **PORTABLE PHONE**

(75) Inventors: **Seog-Guen Kim**, Seoul (KR);  
**Seung-Min Park**, Seoul (KR);  
**Jun-Sang Park**, Anyang-Si (KR)

(73) Assignee: **Samsung Electronics Co., Ltd.**,  
Suwon-Si (KR)

(\*) Notice: This patent is subject to a terminal disclaimer.

(\*\*) Term: **14 Years**

(21) Appl. No.: **29/328,047**

(22) Filed: **Nov. 18, 2008**

(30) **Foreign Application Priority Data**

Sep. 10, 2008 (KR) ..... 30-2008-0039344

(51) **LOC (9) Cl.** ..... **14-03**

(52) **U.S. Cl.** ..... **D14/138 AD**

(58) **Field of Classification Search** ..... D14/138 R,  
D14/138 AD, 138 AC, 138 C, 138 G, 191,  
D14/203.1–203.8, 496, 138 AA, 138 AB,  
D14/247–248, 137, 147, 218, 341–347; D10/65,  
D10/78, 104; D13/168; D18/7; 455/566,  
455/575.1, 575.3

See application file for complete search history.

(56) **References Cited**

**U.S. PATENT DOCUMENTS**

D466,096 S \* 11/2002 Takada ..... D14/138 AD  
D495,695 S \* 9/2004 Yugaya ..... D14/346  
D496,645 S \* 9/2004 Yoo et al. .... D14/138 G  
D503,699 S \* 4/2005 Lee et al. .... D14/138 AD  
D509,202 S \* 9/2005 Lee et al. .... D14/138 AD  
D525,609 S \* 7/2006 Kim et al. .... D14/138 AB  
D526,301 S \* 8/2006 Shin ..... D14/138 AD  
D526,302 S \* 8/2006 Kim ..... D14/138 AD

D529,474 S \* 10/2006 Park et al. .... D14/138 AD  
7,200,224 B2 \* 4/2007 Park et al. .... 379/433.13  
D548,213 S \* 8/2007 Lee et al. .... D14/138 AC  
D549,200 S \* 8/2007 Park et al. .... D14/138 AD  
D559,220 S \* 1/2008 Lee et al. .... D14/138 AD  
D560,192 S \* 1/2008 Lee et al. .... D14/138 AD

(Continued)

**OTHER PUBLICATIONS**

Nokia 6110 Navigator, announced Feb. 2007, [online], [retrieved on Feb. 16, 2007]. Retrieved from Internet ,<URL: <http://www.gsmarena.com>>.\*

(Continued)

*Primary Examiner*—Jeffrey D Asch  
*Assistant Examiner*—Bridget L Eland

(57) **CLAIM**

The ornamental design for a portable phone, as shown and described.

**DESCRIPTION**

FIG. 1 is a perspective view of a portable phone;  
FIG. 2 is a front view of the portable phone of FIG. 1;  
FIG. 3 is a rear view of the portable phone of FIG. 1;  
FIG. 4 is a left-side view of the portable phone of FIG. 1;  
FIG. 5 is a right-side view of the portable phone of FIG. 1;  
FIG. 6 is a top plan view of the portable phone of FIG. 1;  
FIG. 7 is a bottom plan view of the portable phone of FIG. 1;  
and,  
FIG. 8 is a front open view of the portable phone of FIG. 1.

**1 Claim, 6 Drawing Sheets**

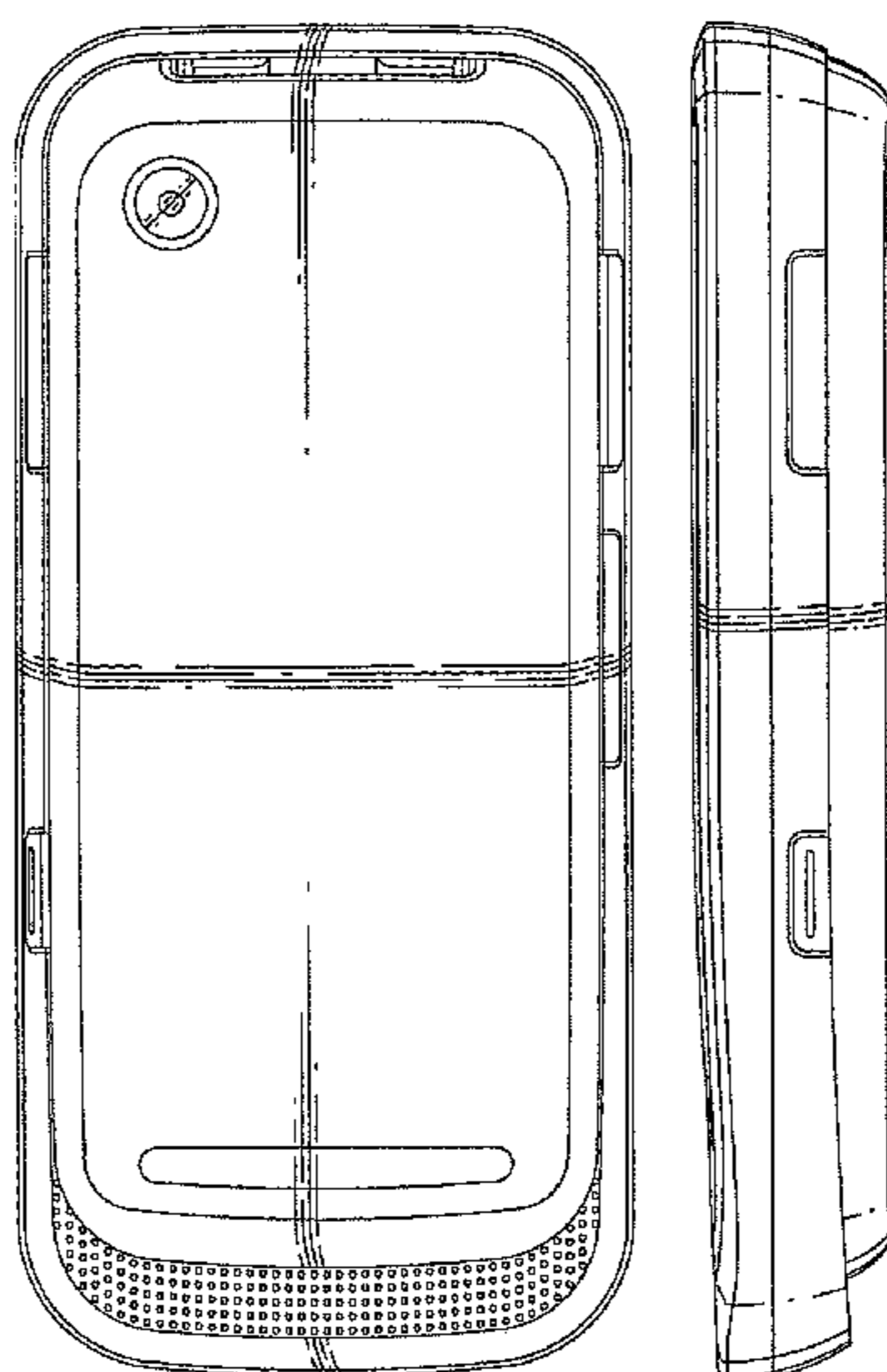

# US D612,824 S

Page 2

---

## U.S. PATENT DOCUMENTS

7,369,882 B2 \* 5/2008 Hwang et al. .... 455/575.1  
D570,815 S \* 6/2008 Son et al. .... D14/138 AD  
D574,015 S \* 7/2008 Masui ..... D14/496  
D579,899 S \* 11/2008 Park et al. .... D14/138 AD  
D580,430 S \* 11/2008 Wei ..... D14/341  
D580,929 S \* 11/2008 Kao et al. .... D14/346  
D583,340 S \* 12/2008 Montin et al. .... D14/138 AD  
D583,343 S \* 12/2008 Lee et al. .... D14/138 AA  
D587,671 S \* 3/2009 Park et al. .... D14/138 AD  
D592,172 S \* 5/2009 Chen ..... D14/138 AD  
2006/0093133 A1 \* 5/2006 Park et al. .... 379/433.12

2006/0205450 A1 \* 9/2006 Amano et al. .... 455/575.4

## OTHER PUBLICATIONS

Philips 960, announced Jul. 2005, [online], [retrieved on Feb. 20, 2007]. Retrieved from Internet ,<URL: <http://www.gsmarena.com>>.\*

LG GM310, announced Feb. 2009, [online], [retrieved on Feb. 20, 2009]. Retrieved from Internet ,<URL: <http://www.gsmarena.com>>.\*

Samsung M3200 Beat s, announced Sep. 2008, [online], [retrieved on Sep. 19, 2008]. Retrieved from Internet ,<URL: <http://www.gsmarena.com>>.\*

\* cited by examiner

FIG. 1

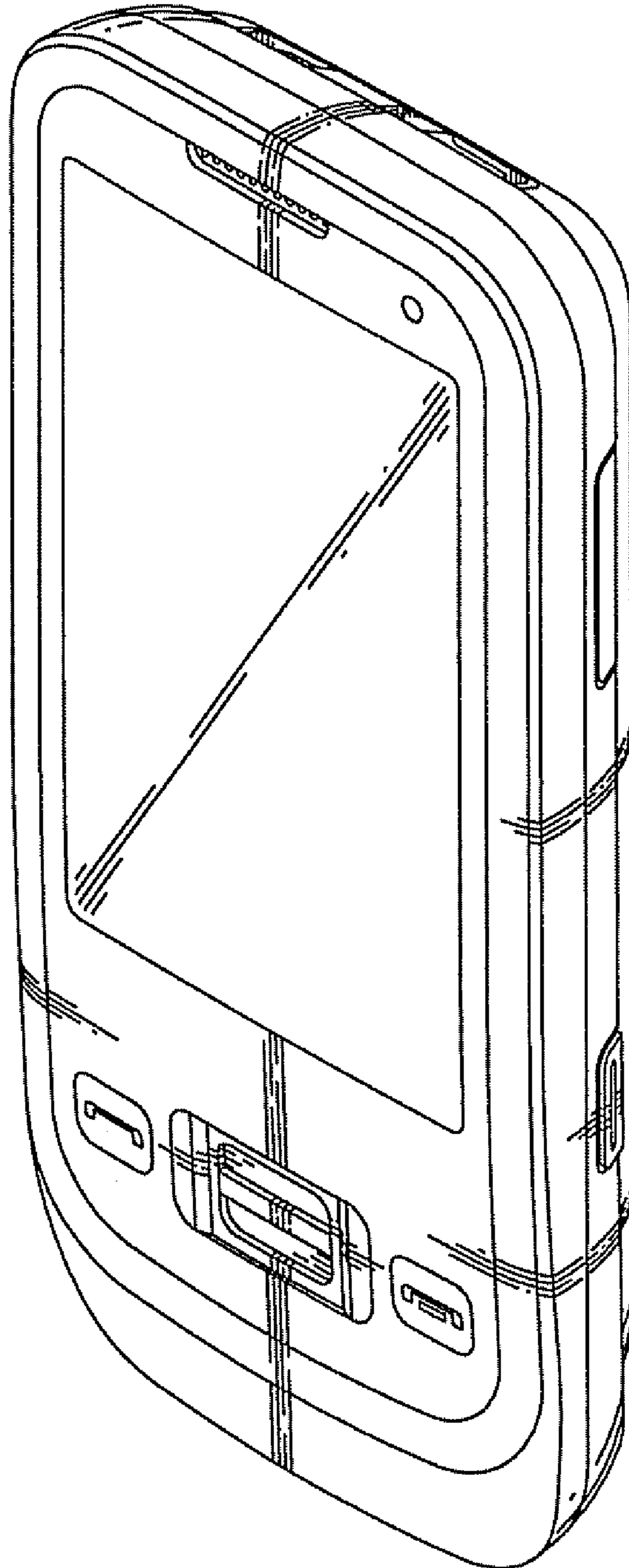

FIG. 2

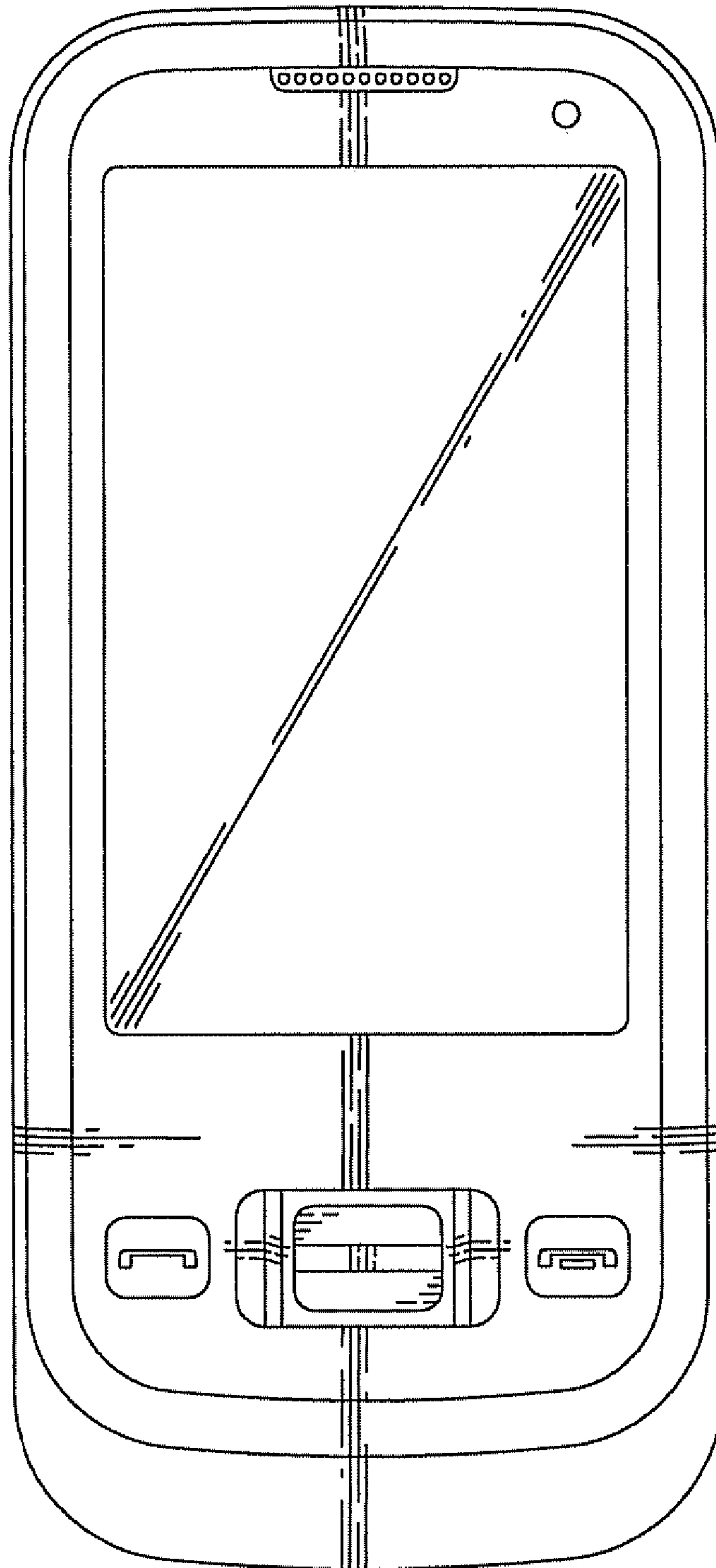

FIG. 3

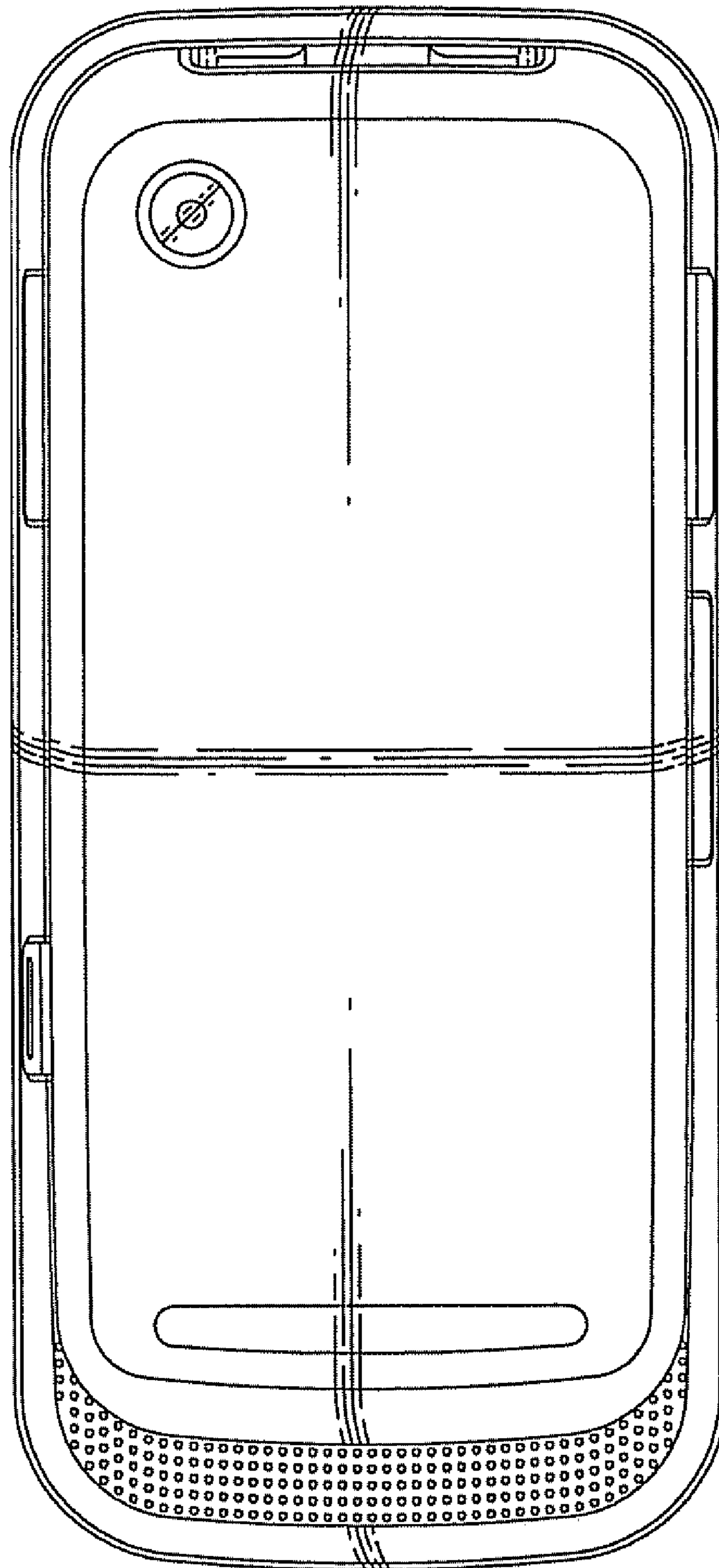

FIG. 4

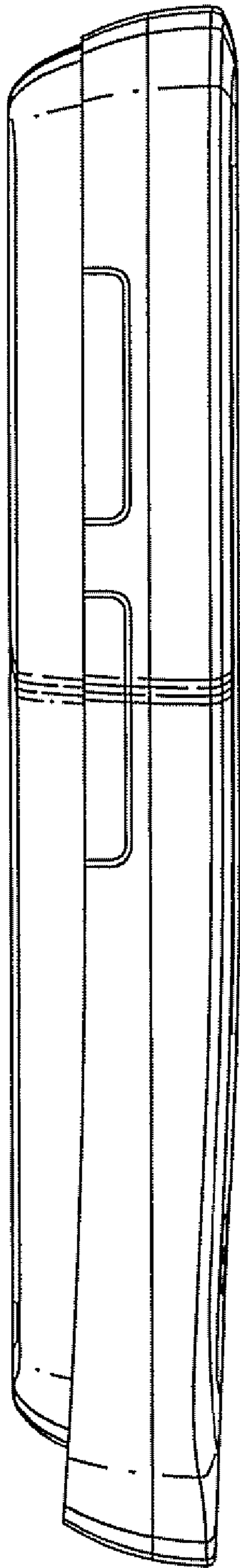

FIG. 5

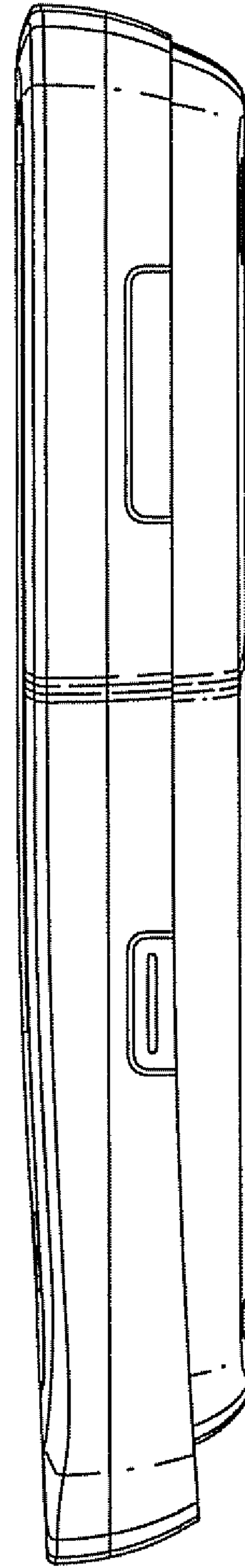

FIG. 6

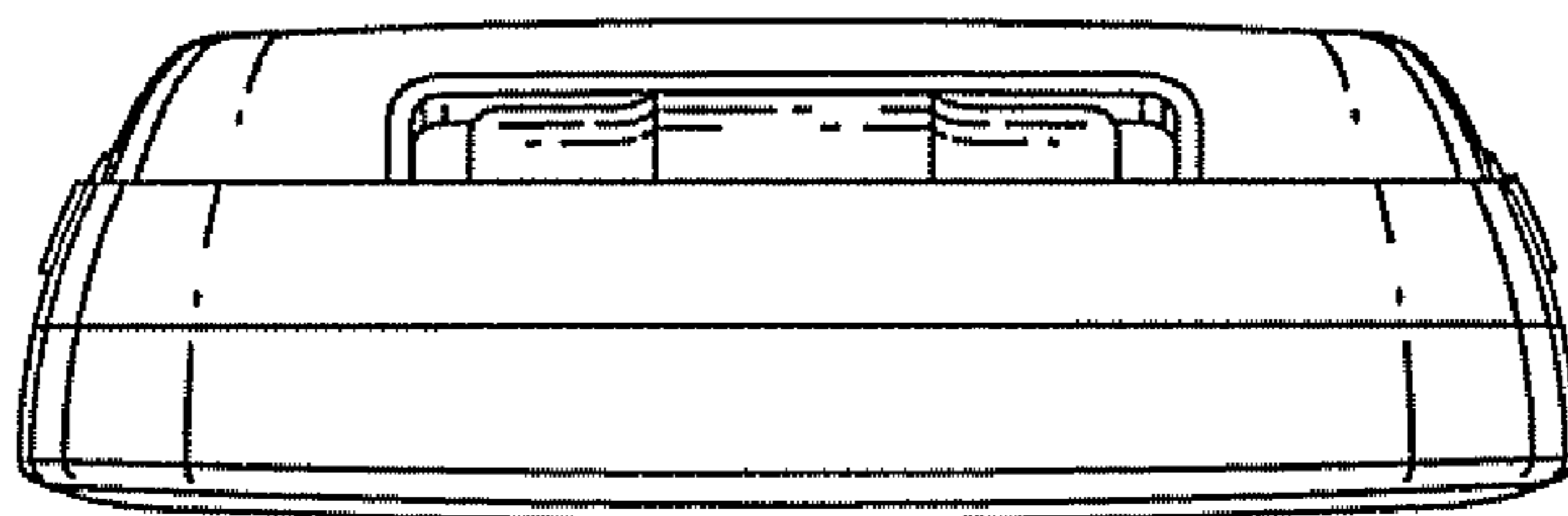

FIG. 7

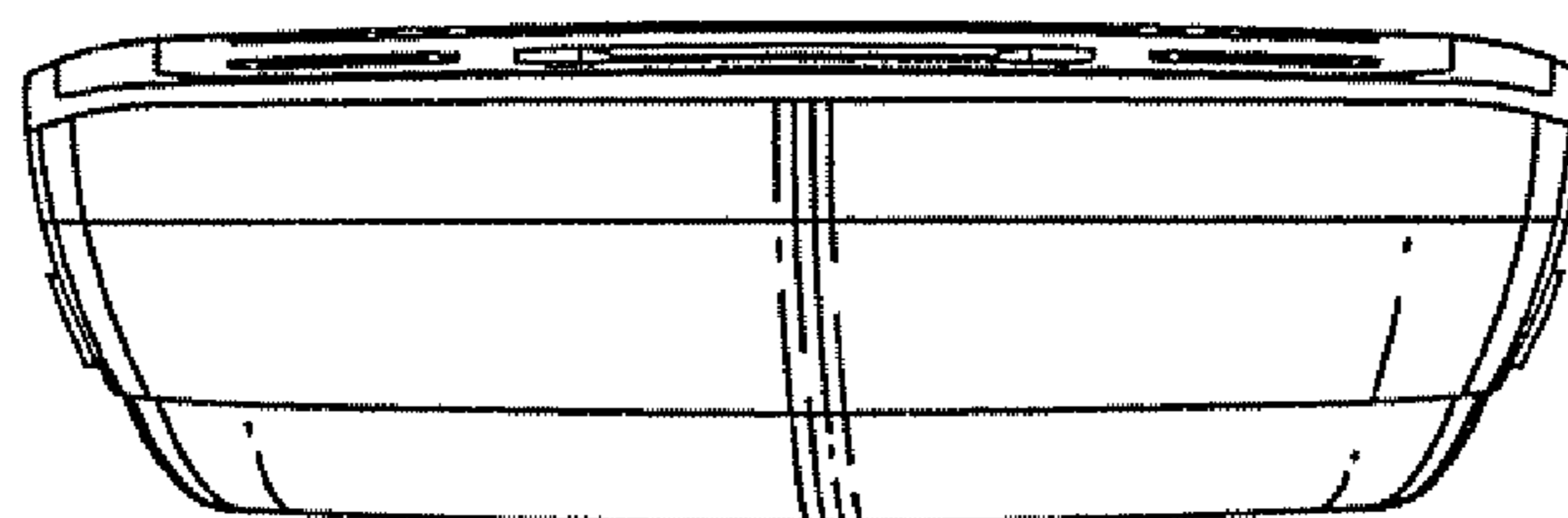

FIG. 8

