



US00D612661S

(12) **United States Design Patent**
Kauer

(10) **Patent No.:** **US D612,661 S**
(45) **Date of Patent:** **** Mar. 30, 2010**

(54) **FOOTBALL HELMET POPCORN MAKER**

(75) Inventor: **Frank Alfred Kauer**, Kowloon (HK)

(73) Assignee: **Access Asia (H.K.) Limited**, Kowloon (HK)

(**) Term: **14 Years**

(21) Appl. No.: **29/342,836**

(22) Filed: **Sep. 2, 2009**

(51) **LOC (9) Cl.** **31-00**

(52) **U.S. Cl.** **D7/325**

(58) **Field of Classification Search** D7/323,
D7/325, 354-361, 500, 606; D10/46.1; D14/371,
D14/403; D19/82; D22/137; D27/148;
D99/37; 2/411; 99/323.4-323.9, 442; 194/297;
220/252; 426/10-107, 241-243

See application file for complete search history.

(56) **References Cited**

U.S. PATENT DOCUMENTS

D369,154 S *	4/1996	Powell	D14/403
D379,023 S *	4/1997	August	D99/37
D426,545 S *	6/2000	Smith et al.	D14/371
D434,607 S *	12/2000	Hansen	D7/606
6,438,762 B1 *	8/2002	Jenkins	2/411
D520,673 S *	5/2006	Wu	D27/148
D545,939 S *	7/2007	Larson	D22/137
D596,670 S *	7/2009	Baker	D19/82

D597,861 S * 8/2009 Cowen et al. D10/46.1

* cited by examiner

Primary Examiner—Caron Veynar

Assistant Examiner—Ricky Pham

(57) **CLAIM**

The ornamental design for a football helmet popcorn maker, as shown and described.

DESCRIPTION

FIG. 1 is a perspective view of a football helmet popcorn maker showing my new design;

FIG. 2 is a front view thereof;

FIG. 3 is a rear view thereof;

FIG. 4 is a left side view thereof;

FIG. 5 is a right side view thereof;

FIG. 6 is a top view thereof;

FIG. 7 is a bottom view thereof;

FIG. 8 is a perspective view in alternative position of a football helmet popcorn maker, shown with the top in an open position;

FIG. 9 is a front view thereof;

FIG. 10 is a rear view thereof;

FIG. 11 is a left side view thereof;

FIG. 12 is a right side view thereof;

FIG. 13 is a top view thereof; and,

FIG. 14 is a bottom view thereof.

1 Claim, 14 Drawing Sheets

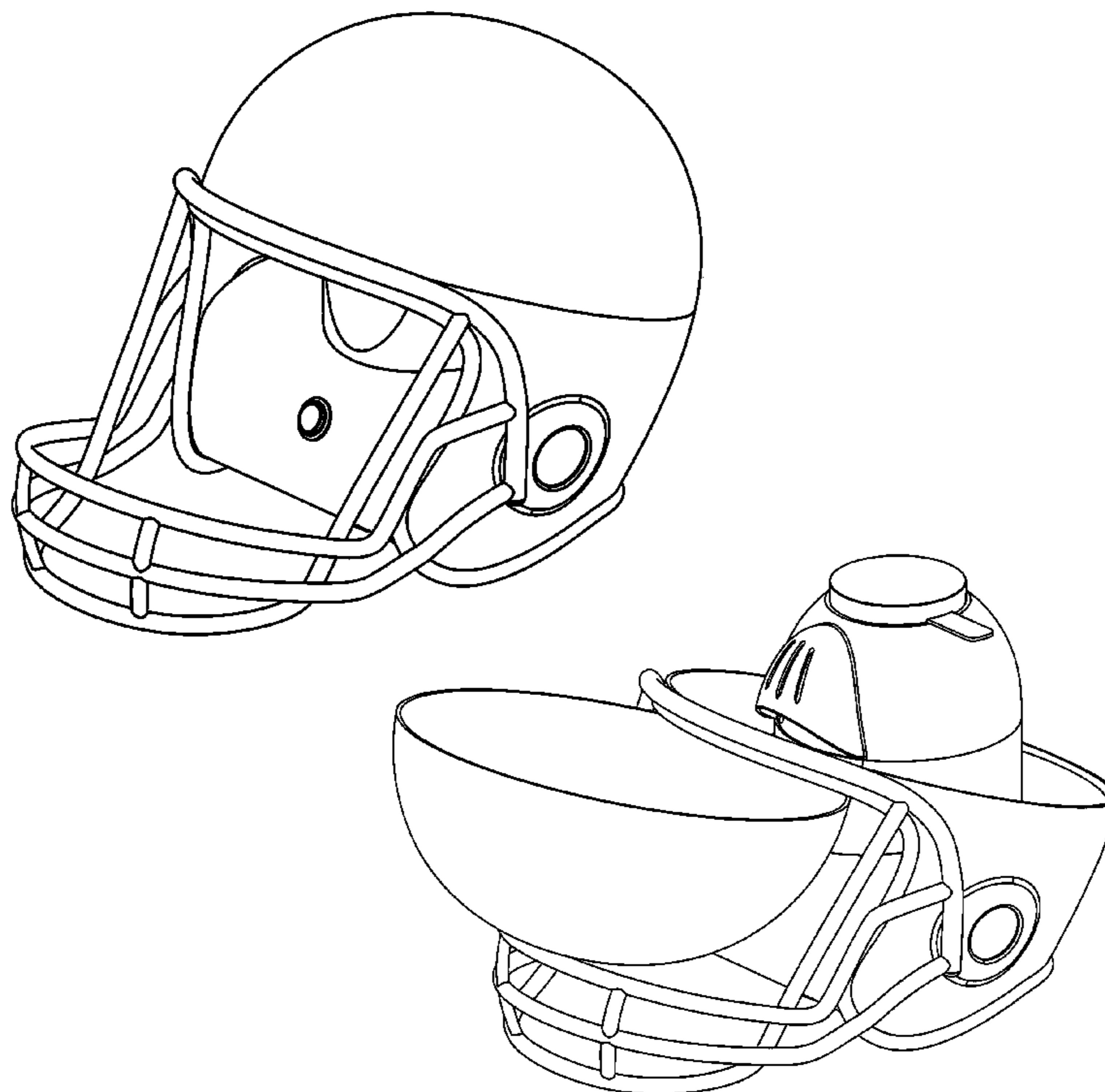

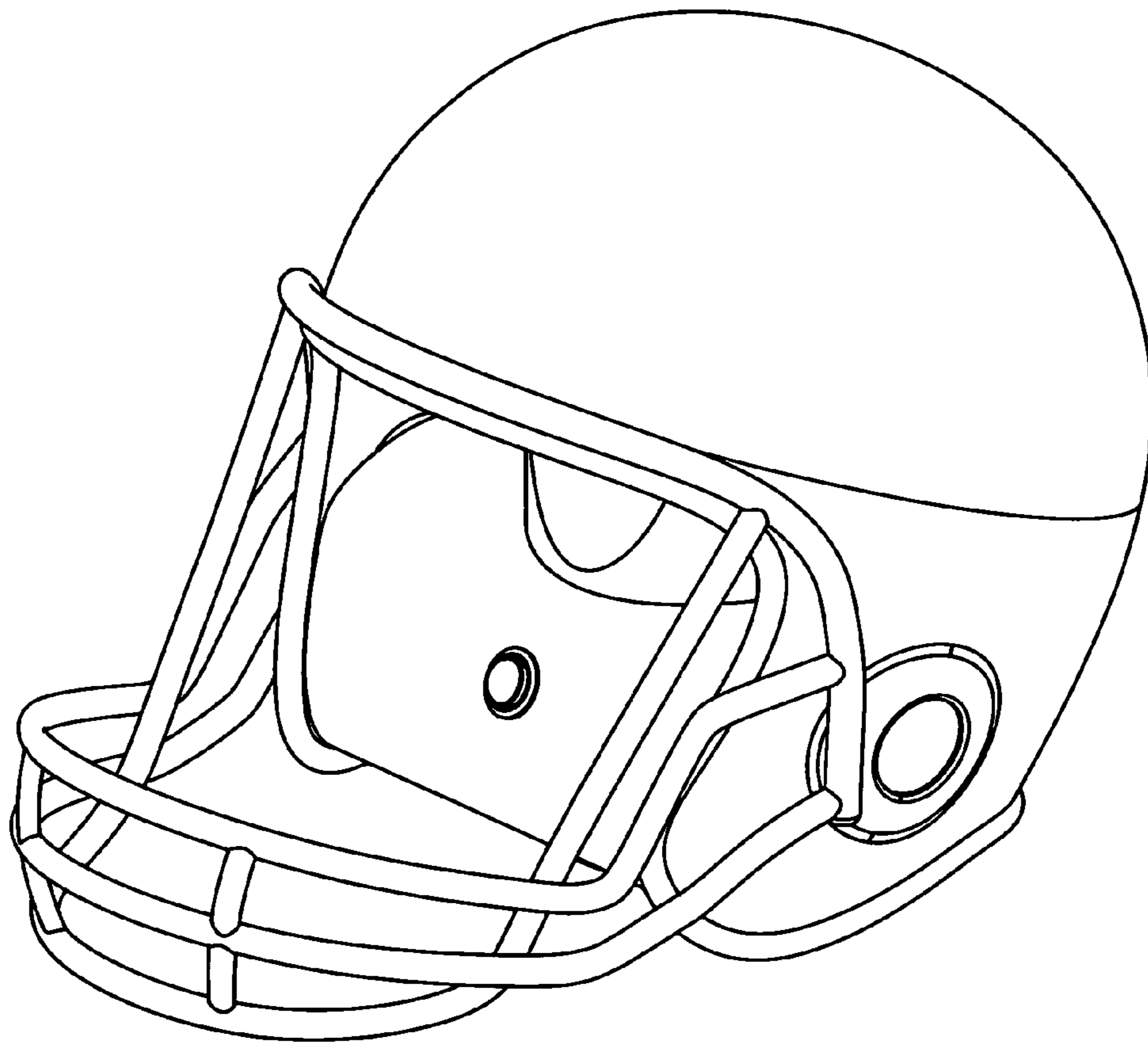

FIG. 1

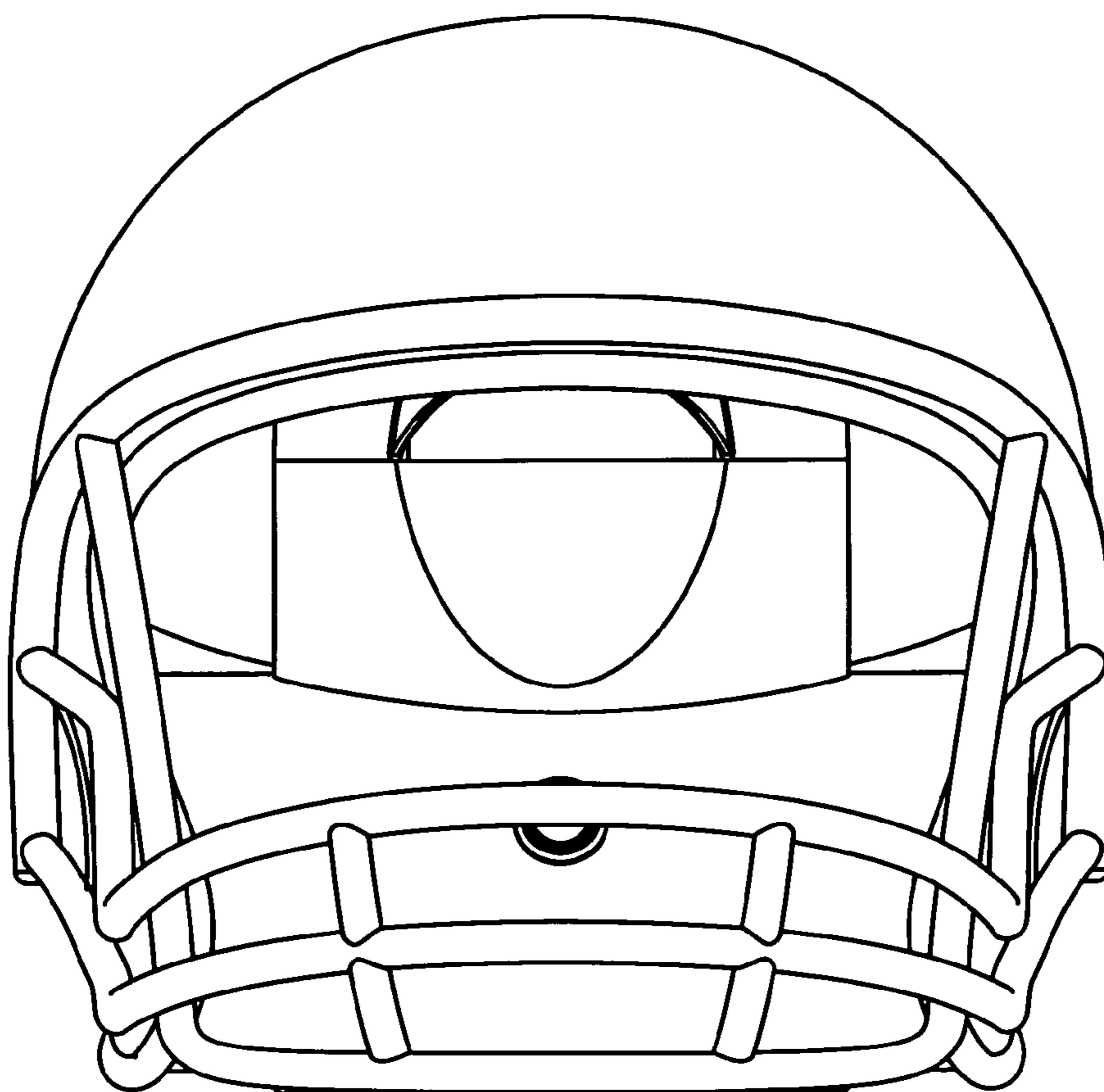

FIG. 2

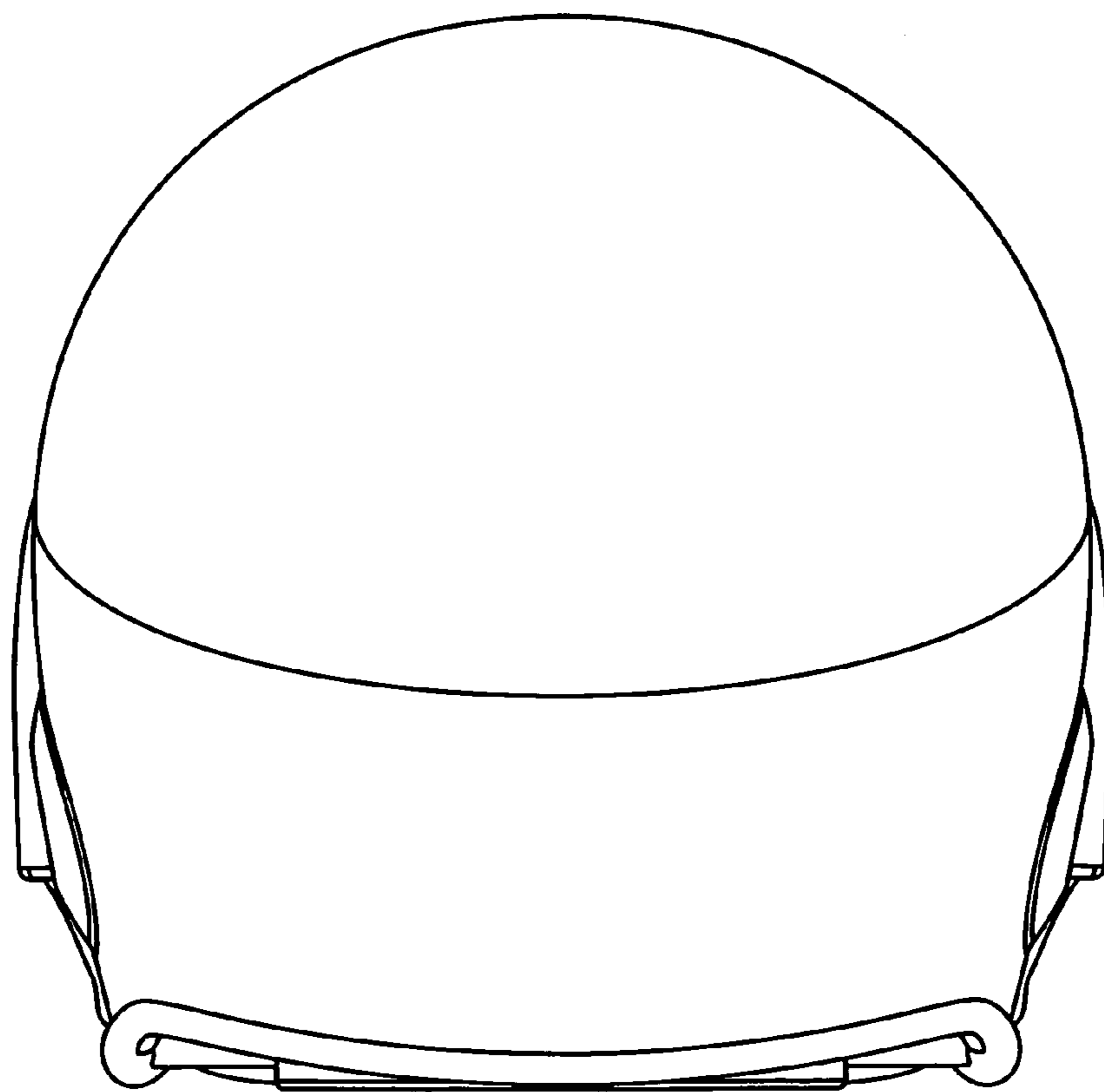

FIG. 3

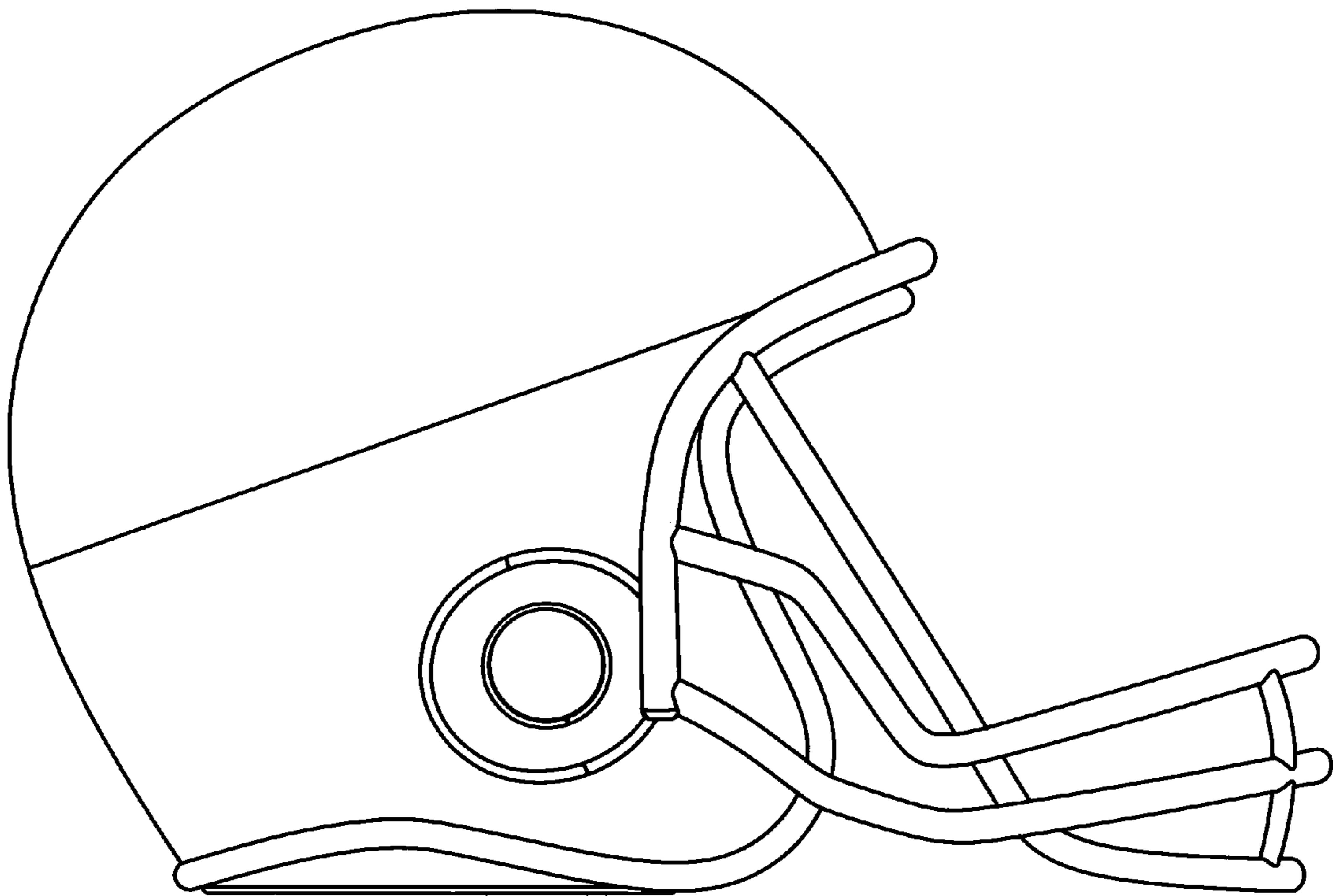

FIG. 4

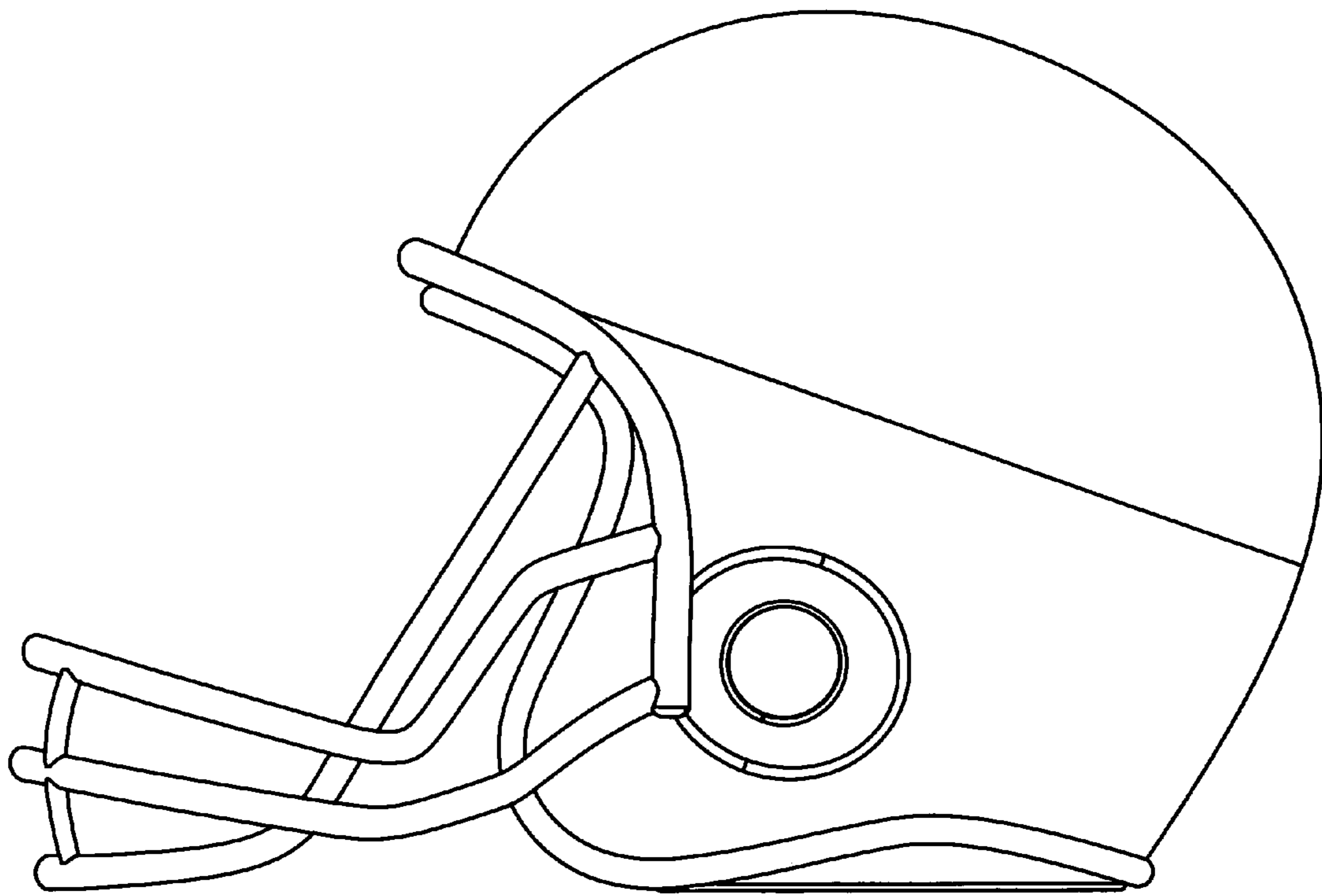

FIG. 5

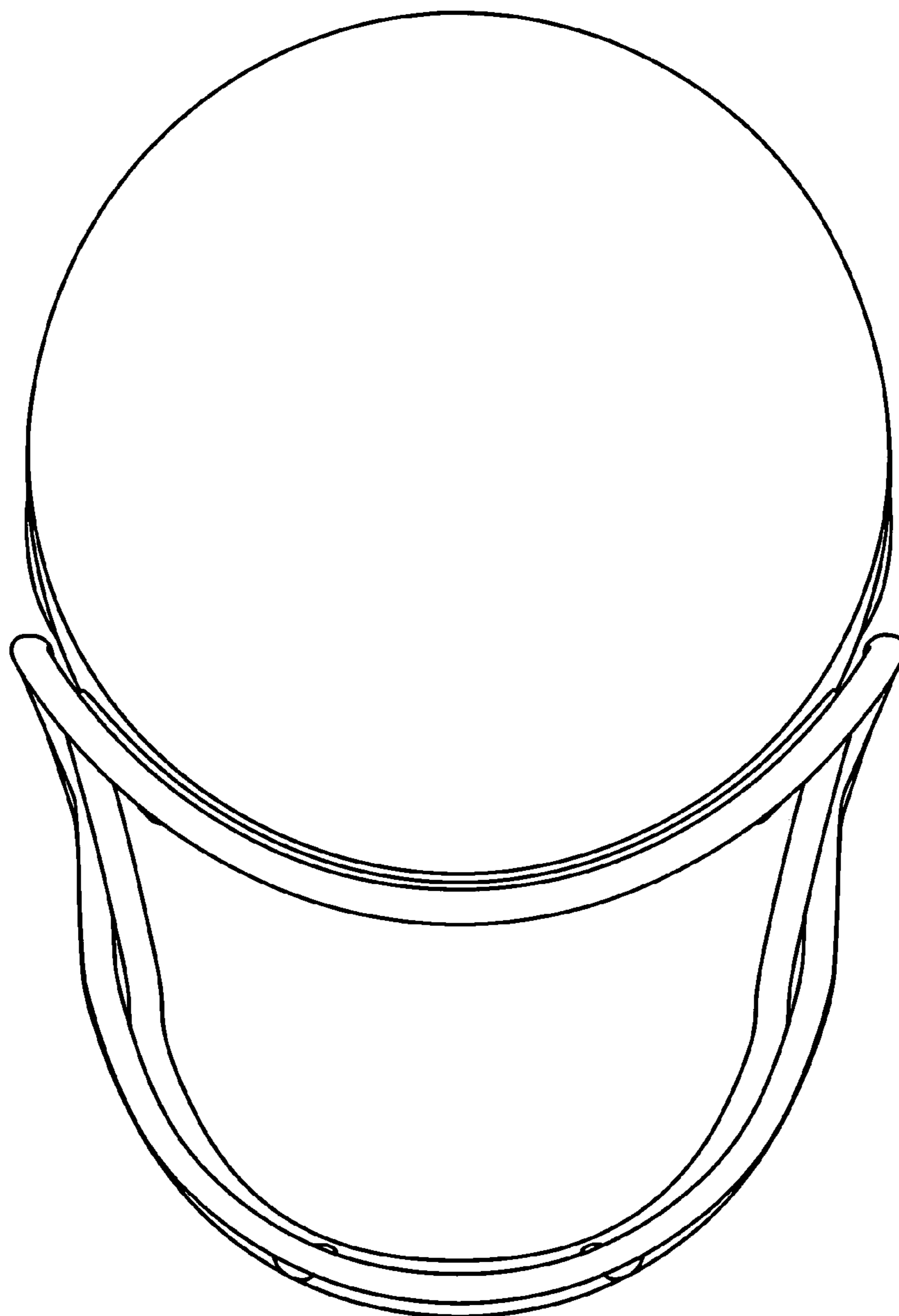

FIG. 6

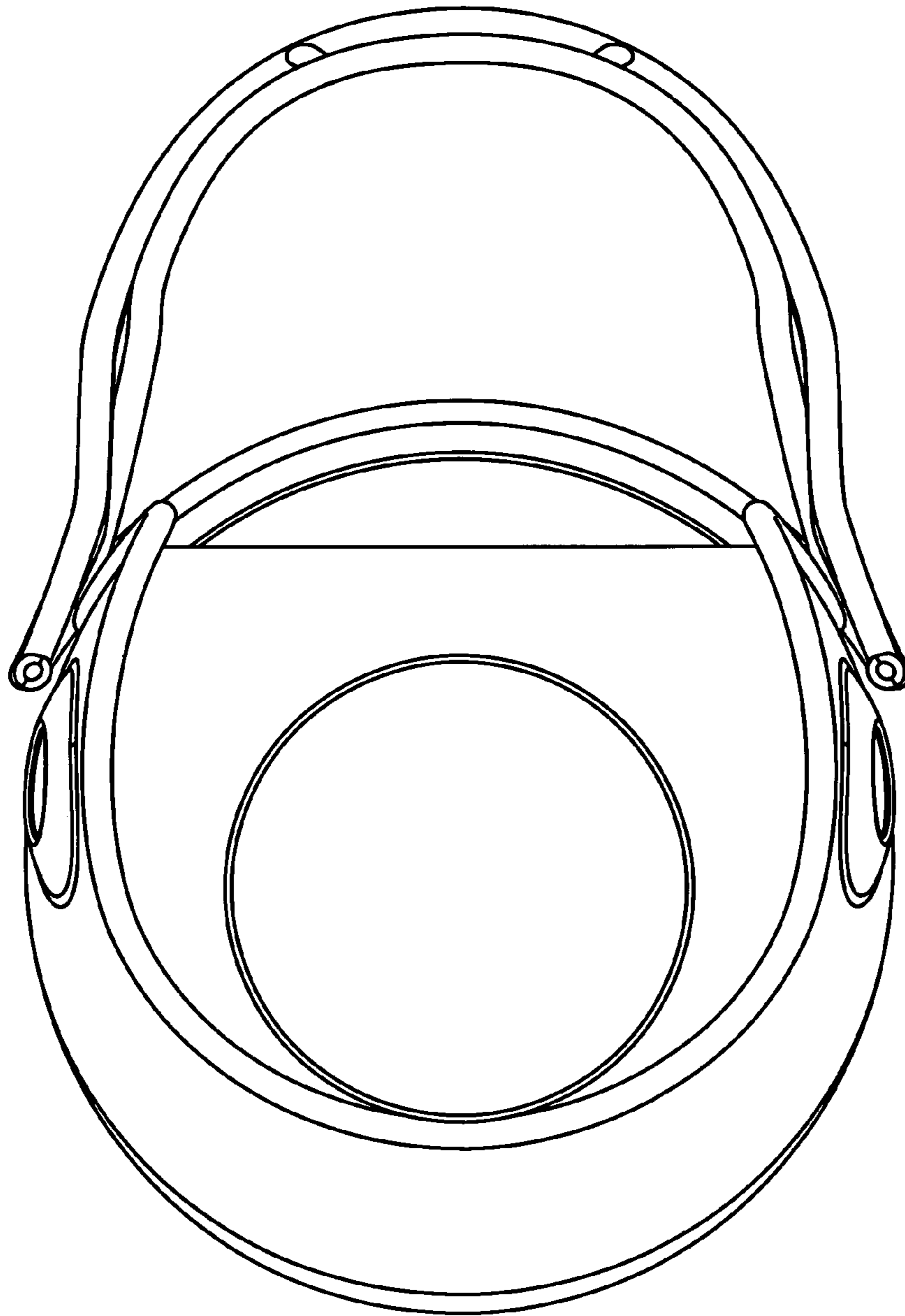

FIG. 7

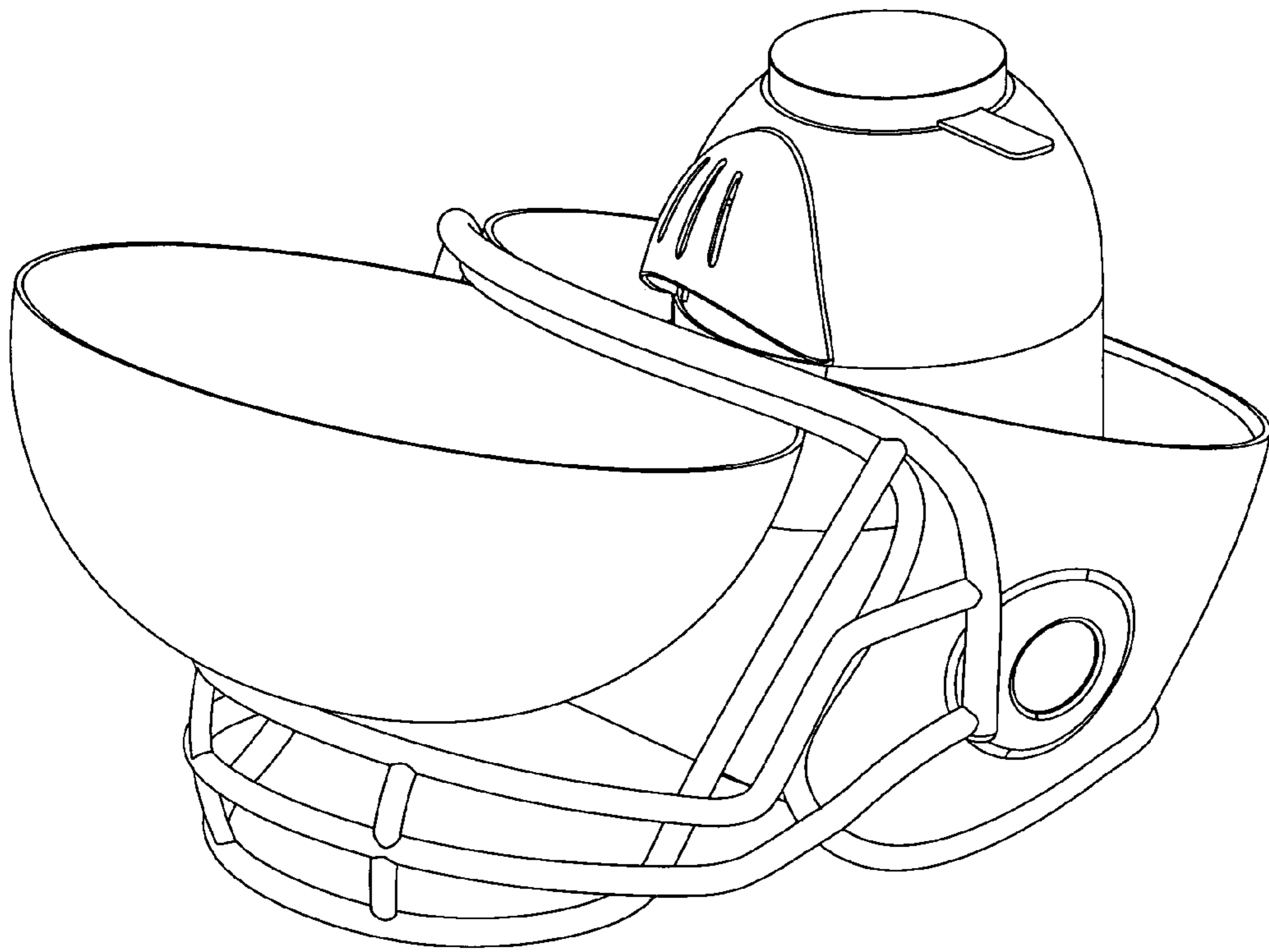

FIG. 8

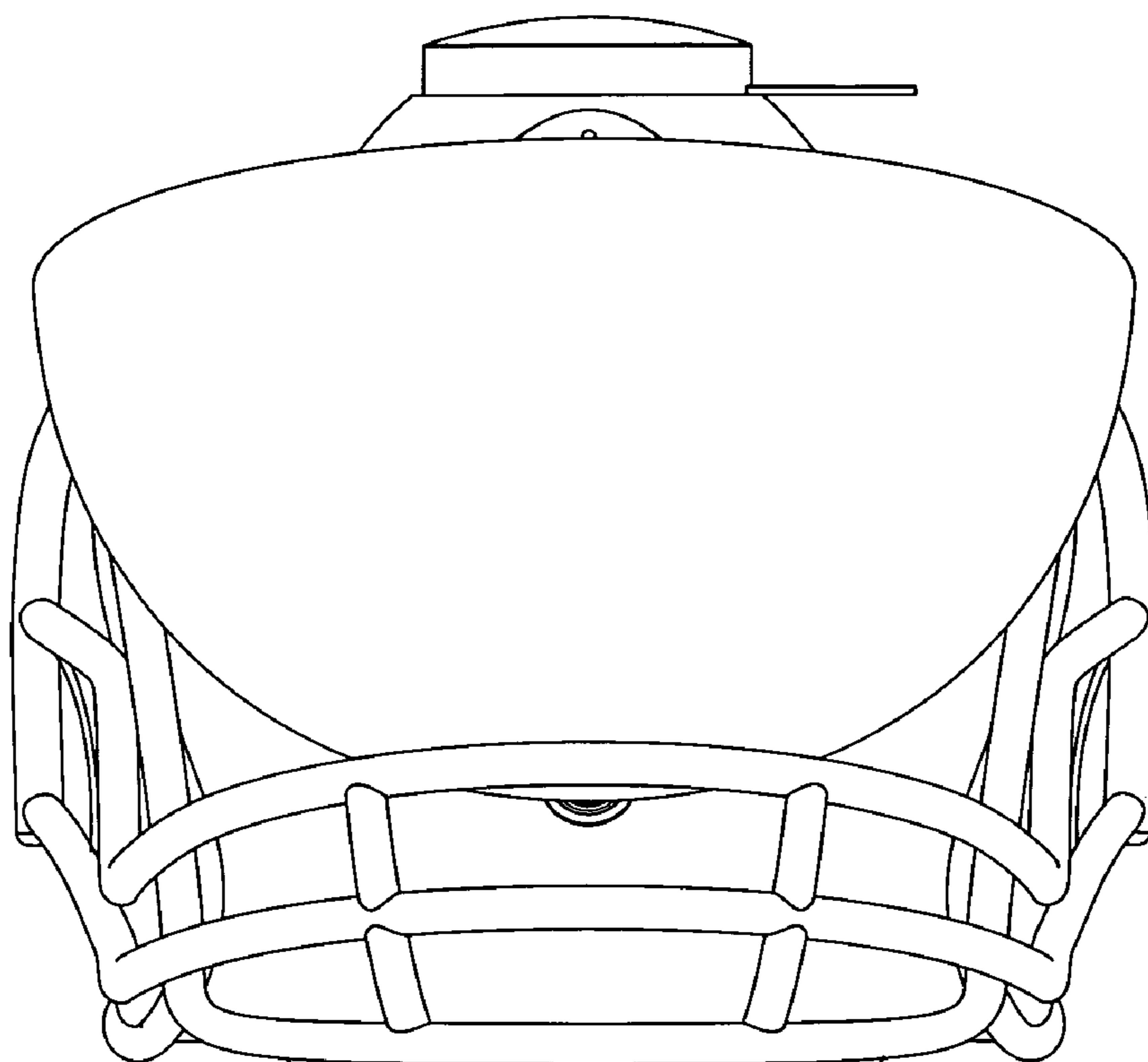

FIG. 9

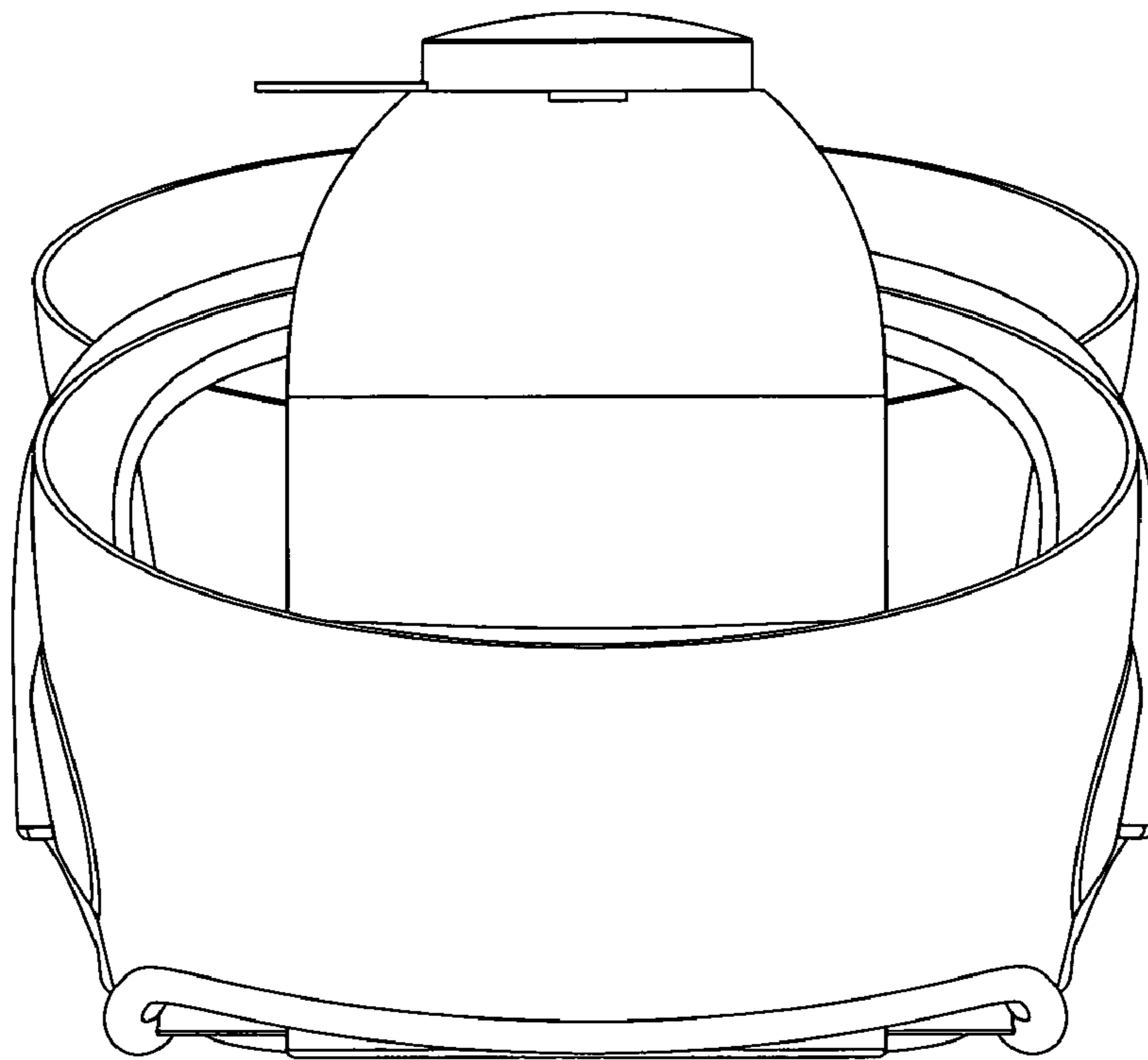

FIG. 10

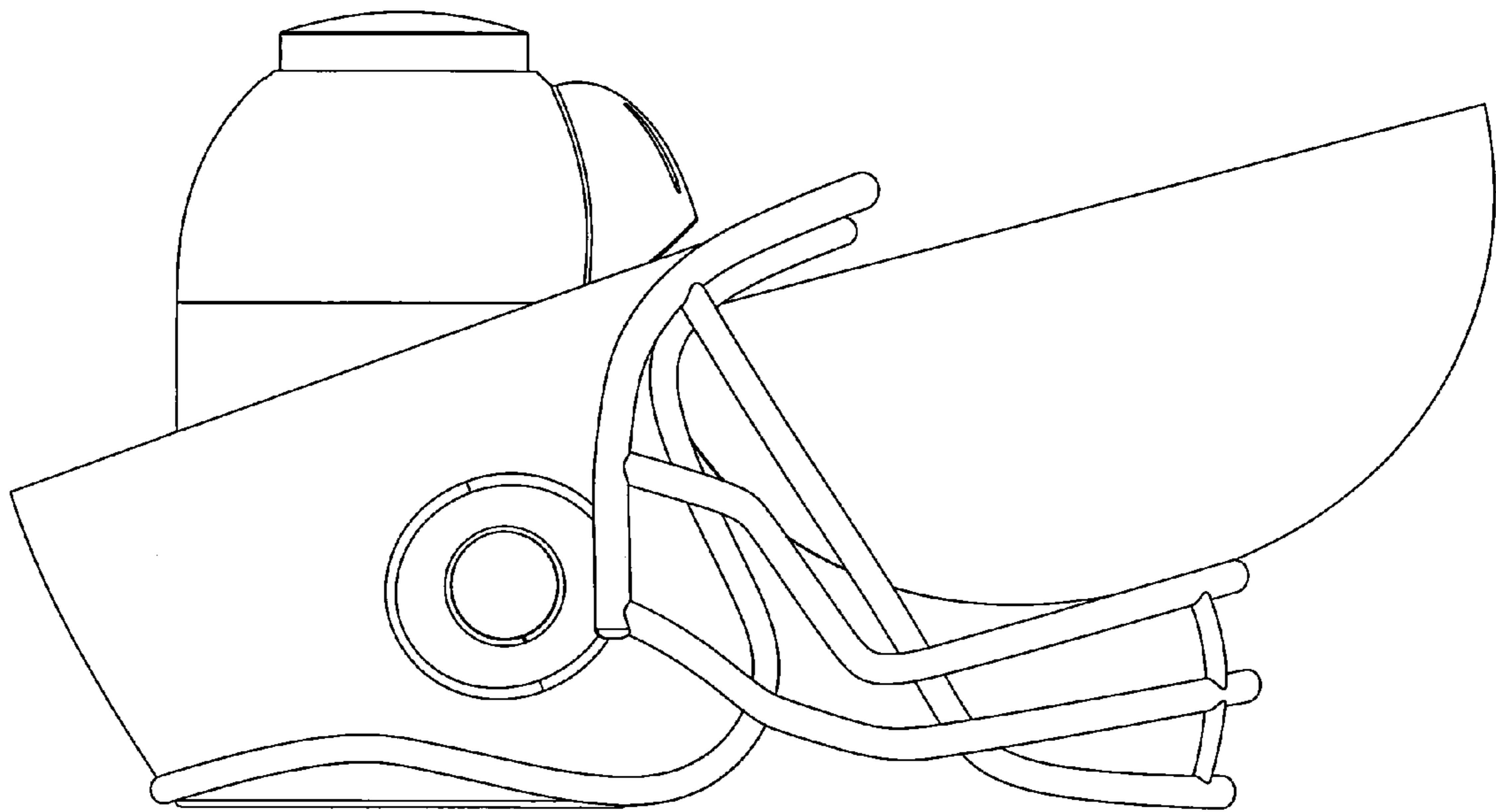

FIG. 11

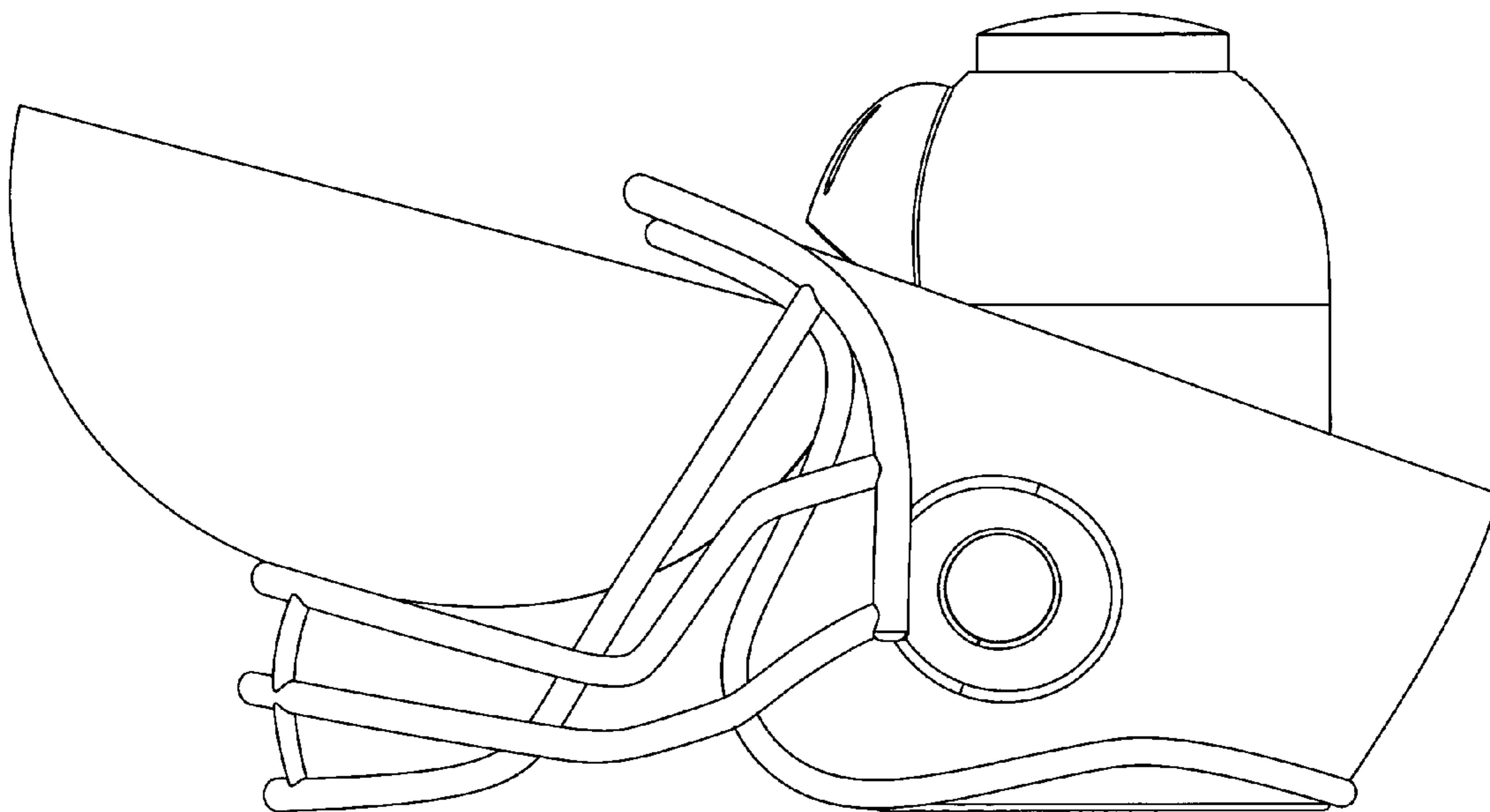

FIG. 12

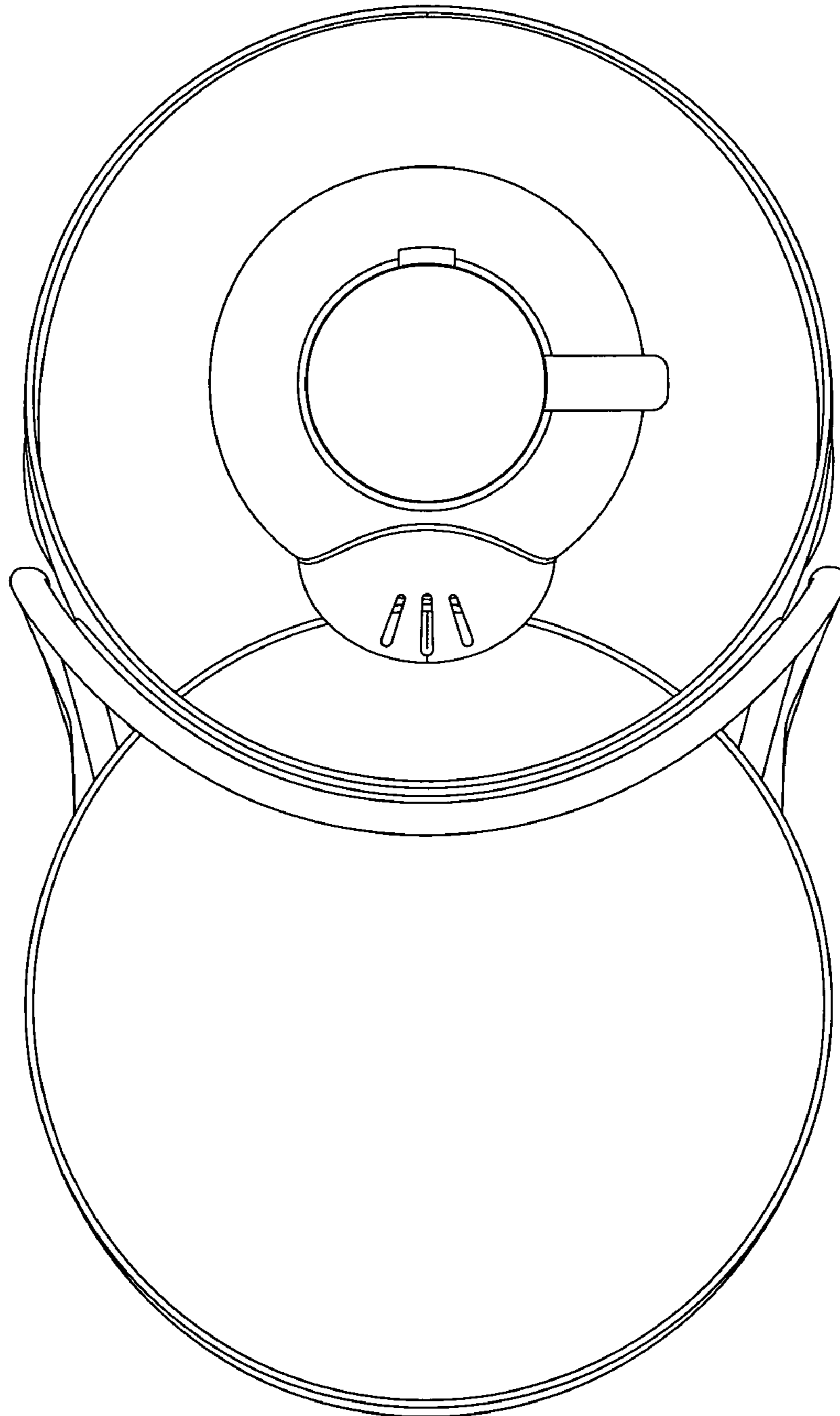

FIG. 13

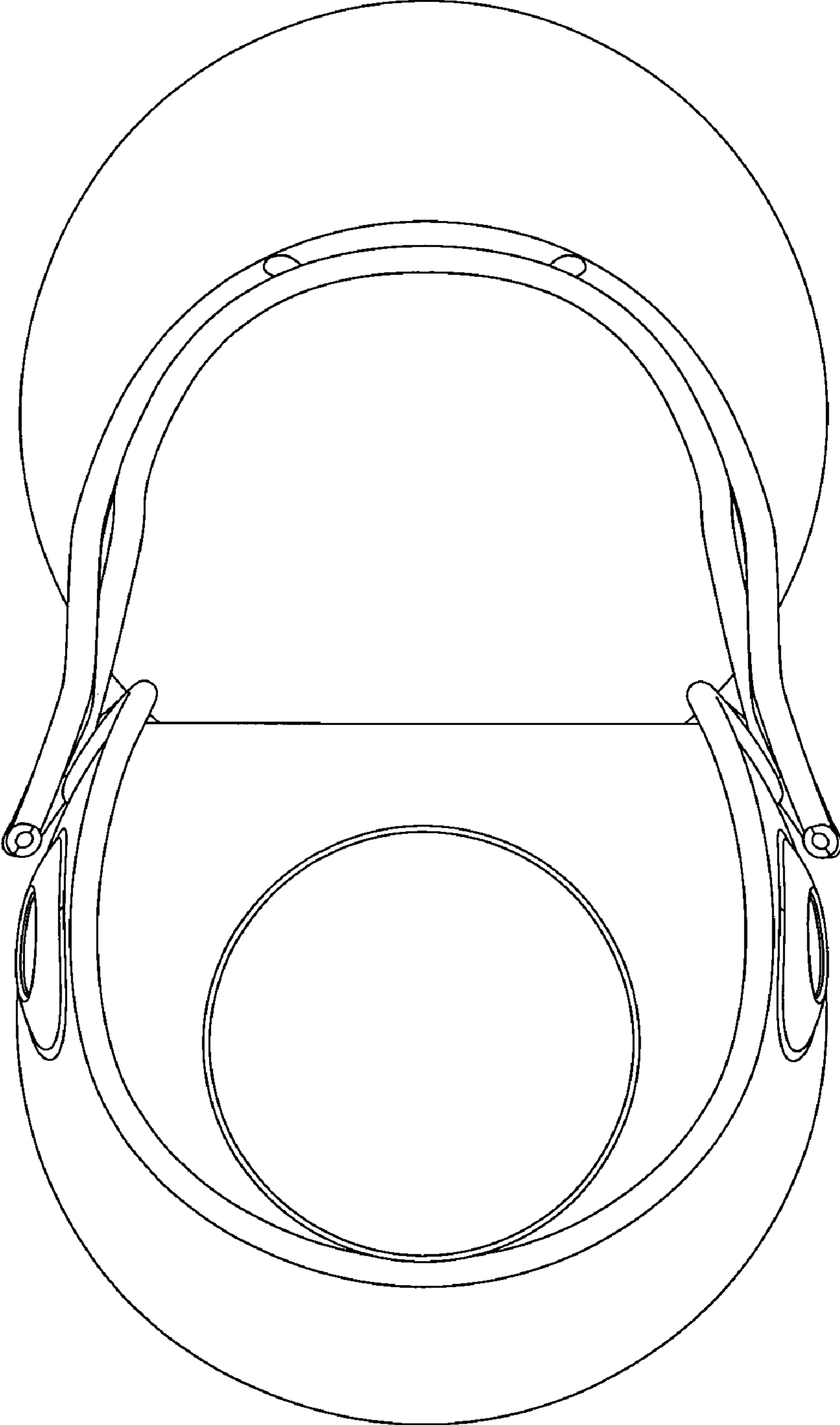

FIG. 14