



US00D612492S

(12) **United States Design Patent**
Krumins

(10) **Patent No.:** **US D612,492 S**
(45) **Date of Patent:** **** Mar. 23, 2010**

(54) **FLUID DELIVERY SYSTEM**

(76) Inventor: **Tiffany Krumins**, 407 Wynbrook Dr.,
Auburn, GA (US) 30011

(**) Term: **14 Years**

(21) Appl. No.: **29/336,358**

(22) Filed: **May 1, 2009**

(51) **LOC (9) Cl.** **24-01**

(52) **U.S. Cl.** **D24/127; D24/108; D24/195;**
D23/256; D21/616; D21/697

(58) **Field of Classification Search** **D24/107-108,**
D24/112, 195; D23/256; 604/175, 244,
604/539; 606/234-236; 607/77; D9/601,
D9/606, 610; D11/232-233, 238-239, 30-31,
D11/49, 100, 157-158, 172-173, 50; D21/616,
D21/659, 697

See application file for complete search history.

(56) **References Cited**

U.S. PATENT DOCUMENTS

2,860,639	A *	11/1958	Hoover	D24/195
3,426,755	A	2/1969	Clegg		
4,127,126	A *	11/1978	Schunk	D24/112
D276,653	S *	12/1984	Daugherty	D24/195
D282,563	S *	2/1986	Beene	D23/256

D326,313	S *	5/1992	Frankel	D23/256
5,167,638	A *	12/1992	Felix et al.	D24/108
D417,275	S *	11/1999	Conforti	D24/130
D428,140	S *	7/2000	Swan	D24/112
D448,844	S *	10/2001	Reis	D23/114
6,357,626	B1	3/2002	Zhang et al.		
6,863,681	B2 *	3/2005	Dickerson	D24/194
2005/0194005	A1	9/2005	Berube et al.		

* cited by examiner

Primary Examiner—Robert A Delehanty

(74) *Attorney, Agent, or Firm*—Paparella & Associates, PC;
Joseph A. Paparella

(57) **CLAIM**

I claim the ornamental design for a fluid delivery system, as shown.

DESCRIPTION

FIG. 1 is a front perspective view of the fluid delivery system;
FIG. 2 is a left side view thereof;
FIG. 3 is a front view of the fluid delivery system;
FIG. 4 is a rear view thereof;
FIG. 5 is a top view thereof; and,
FIG. 6 is a bottom view thereof.

1 Claim, 4 Drawing Sheets

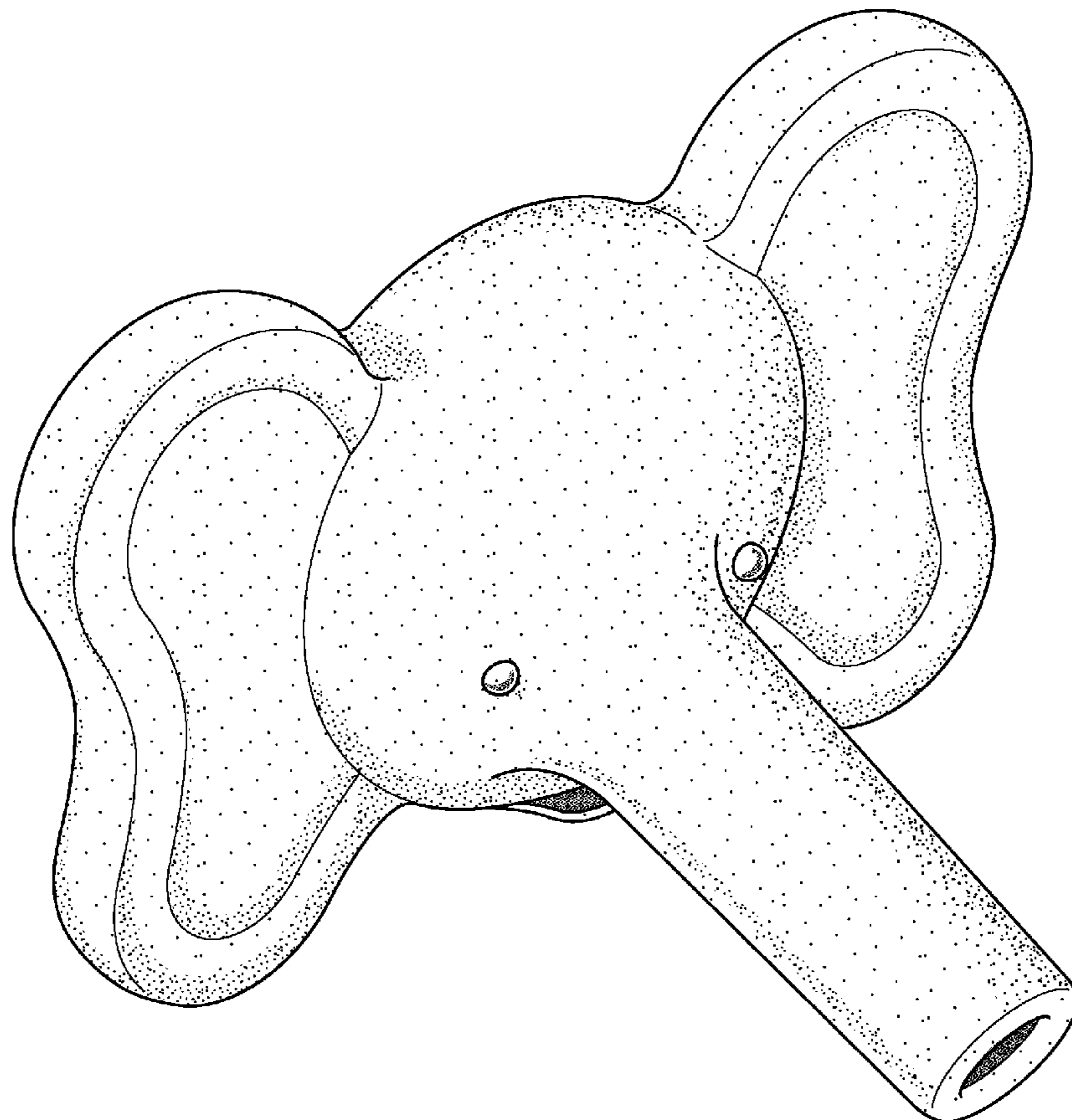

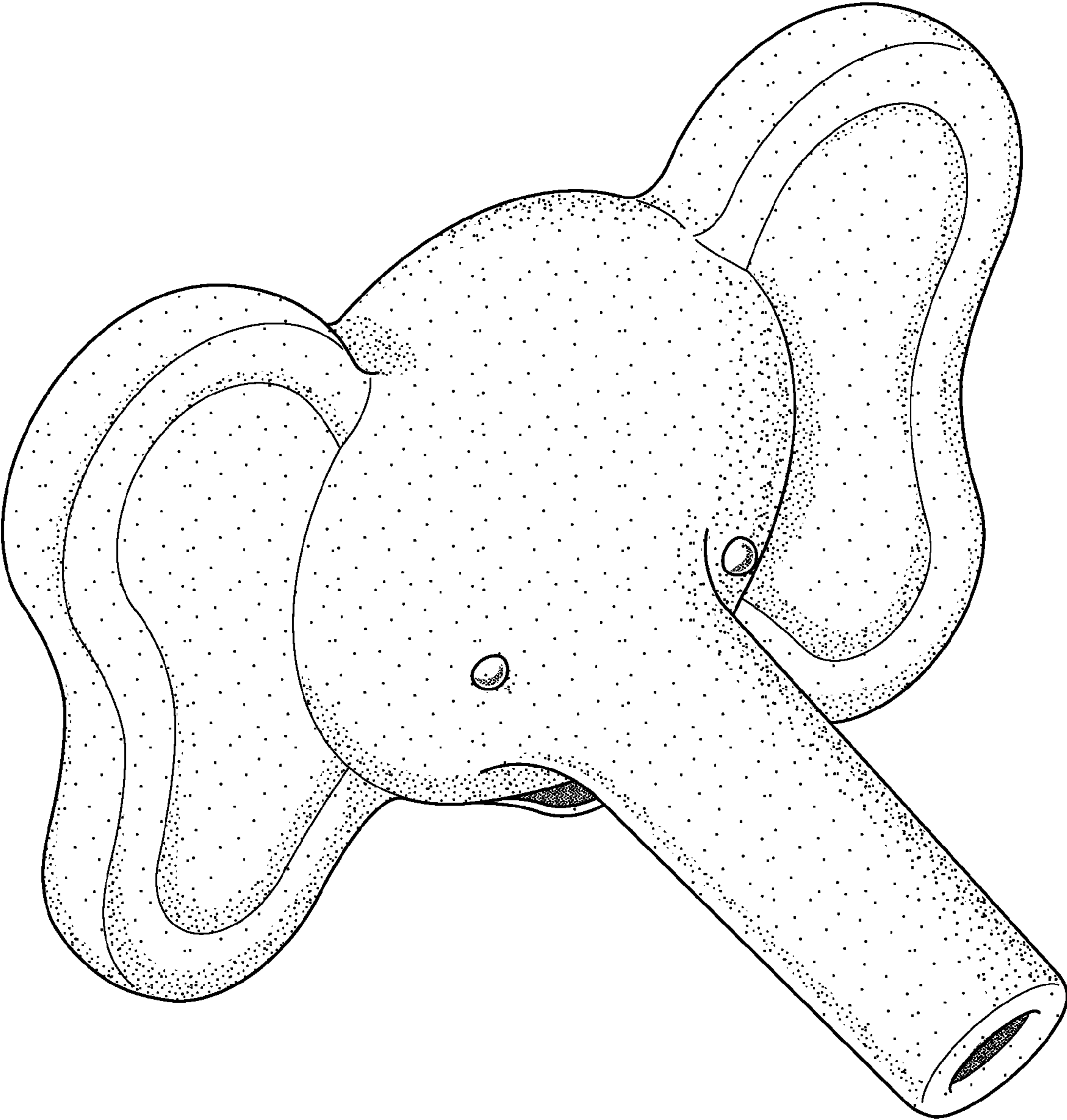

Fig. 1

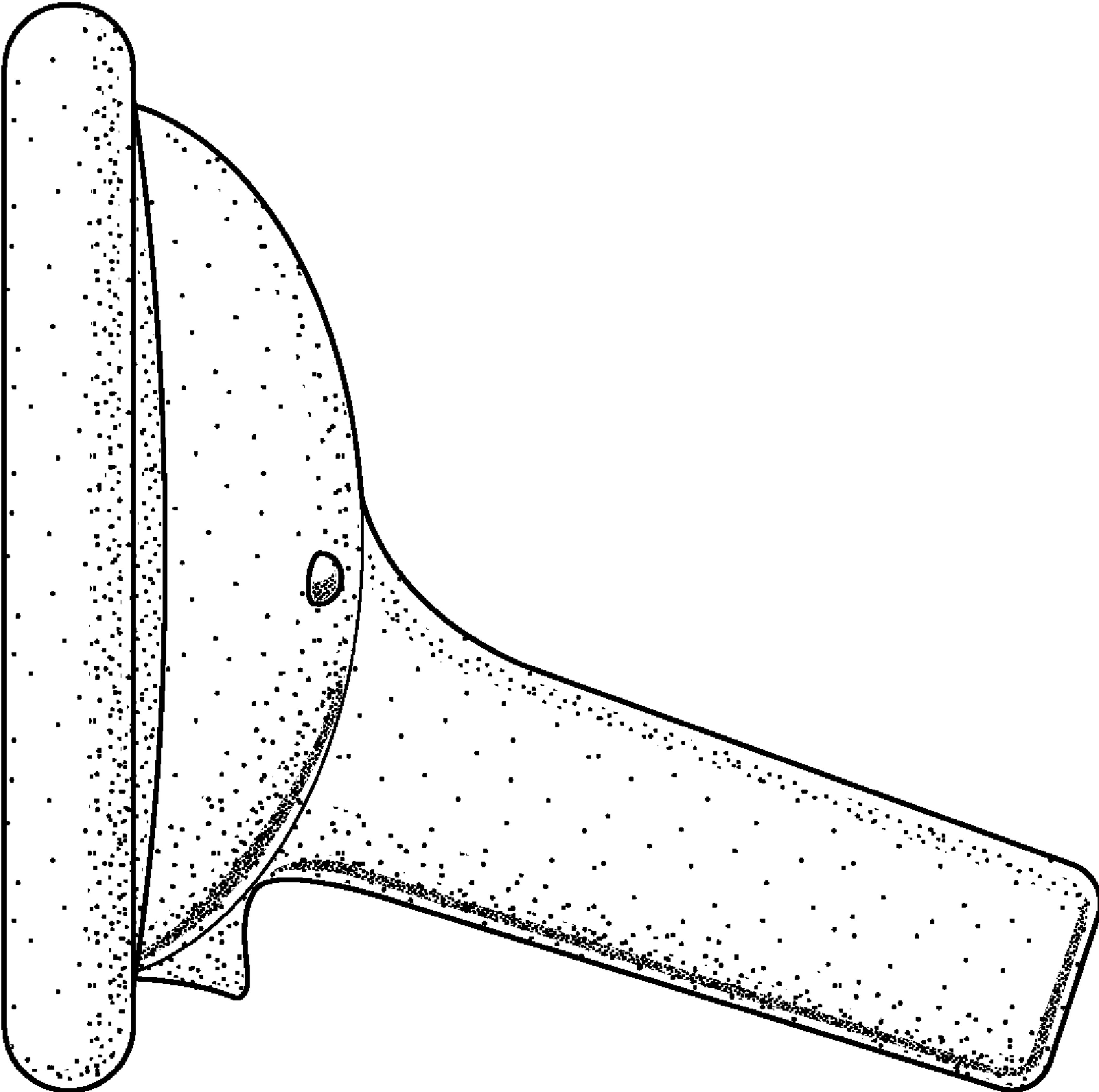

Fig. 2

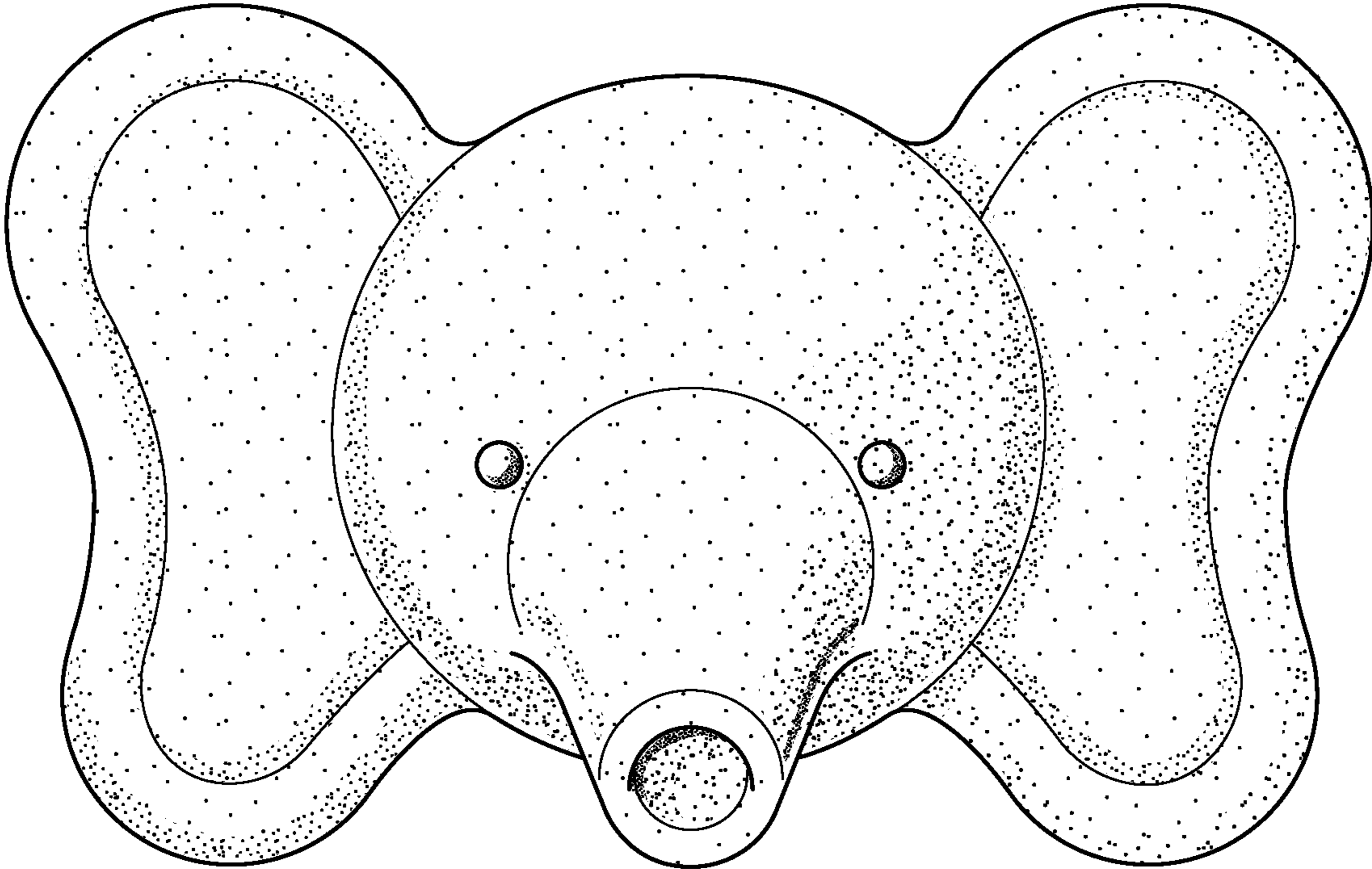

Fig. 3

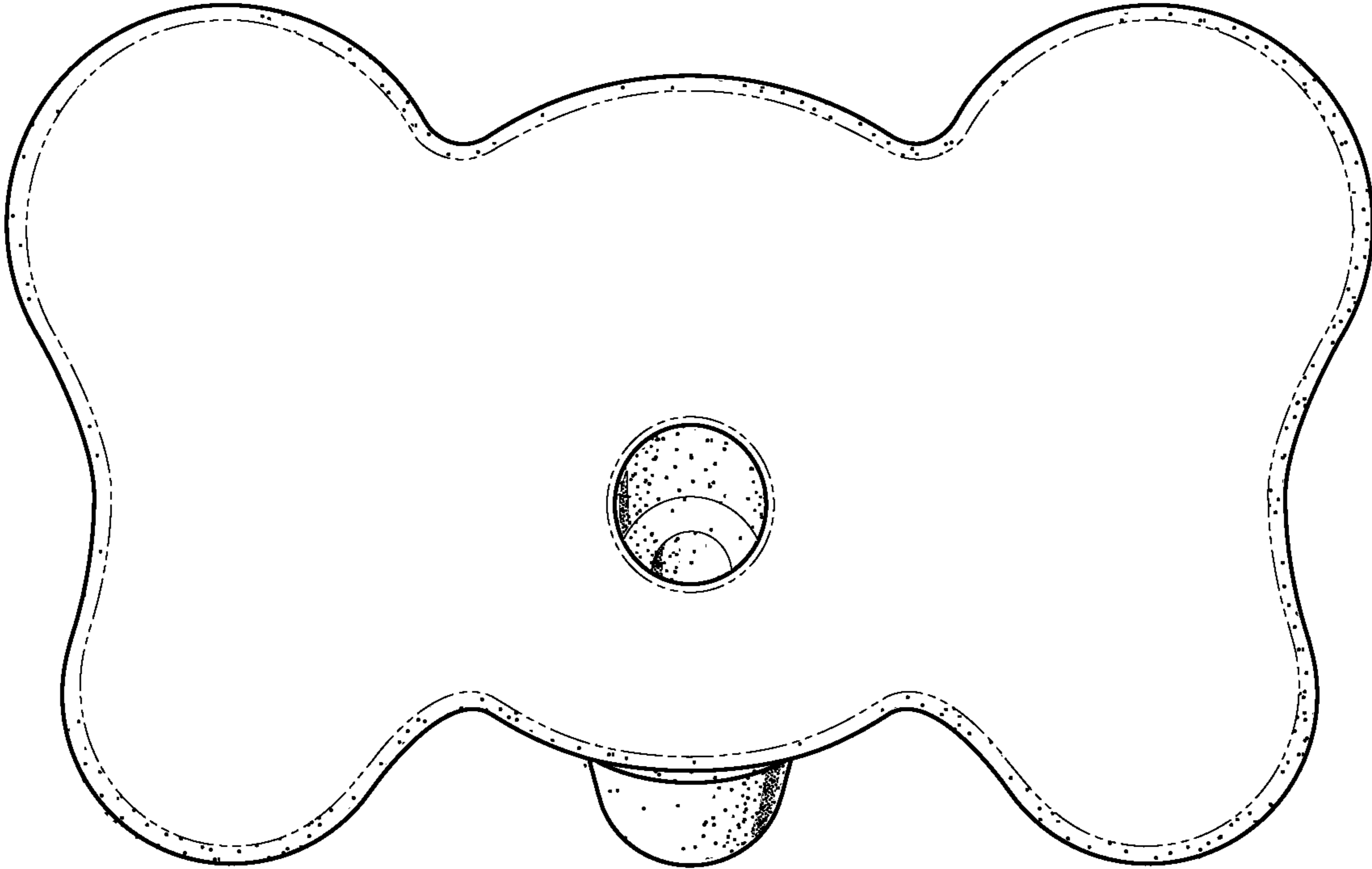

Fig. 4

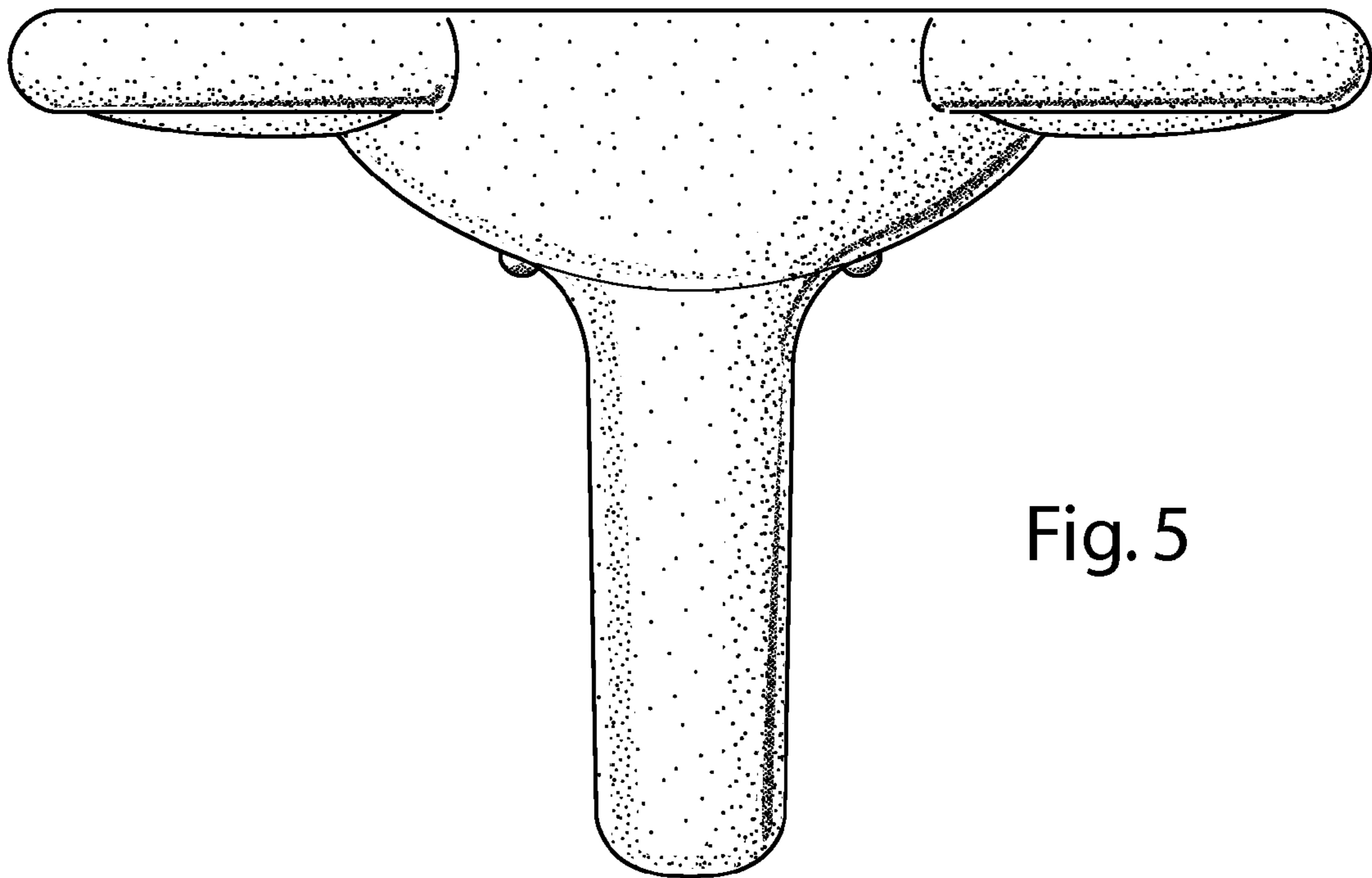

Fig. 5

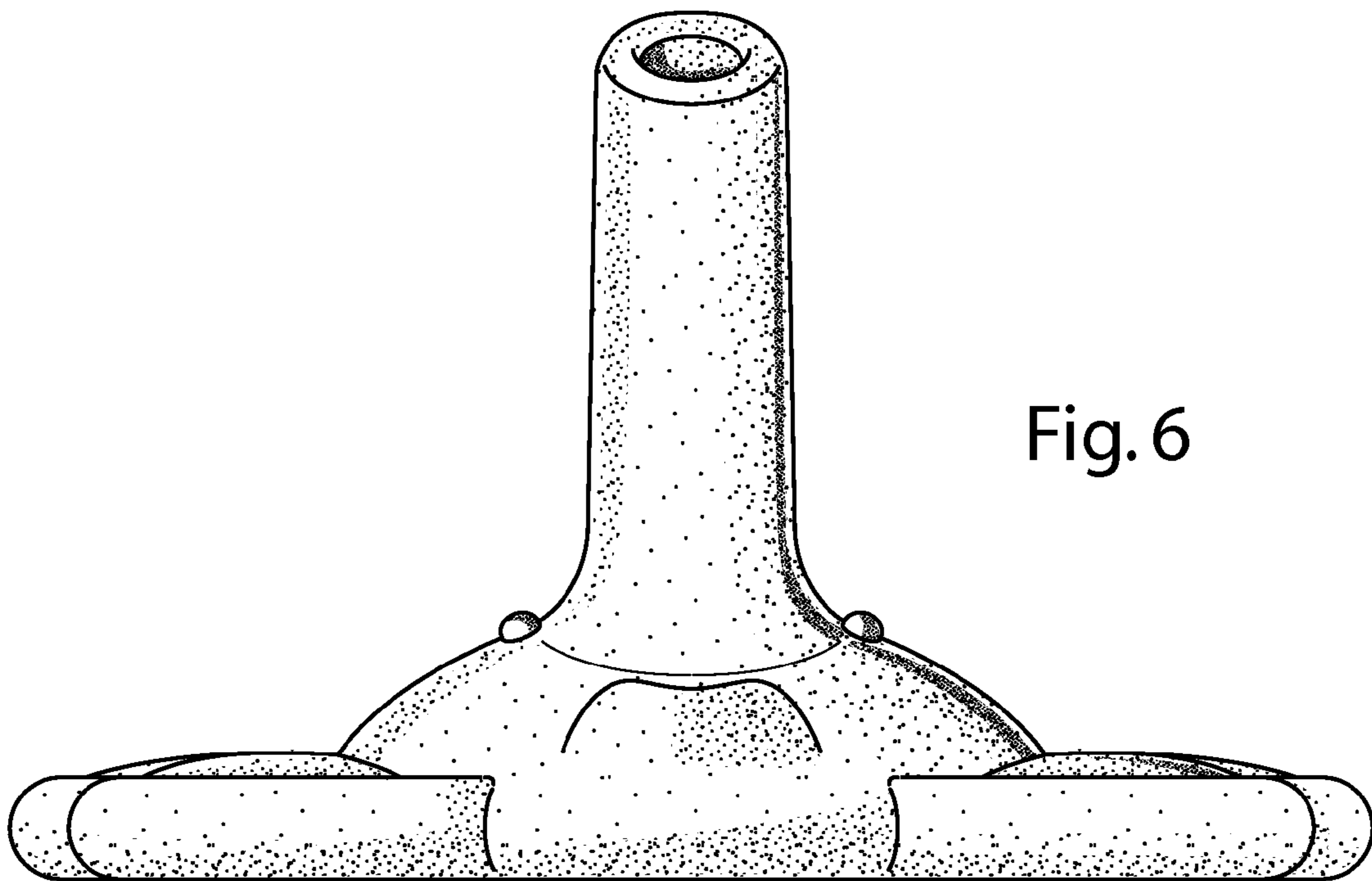

Fig. 6