



US00D612449S

(12) **United States Design Patent**  
**Flowers et al.**

(10) **Patent No.:** **US D612,449 S**  
(45) **Date of Patent:** **\*\* Mar. 23, 2010**

(54) **SHOWERHEAD**

(75) Inventors: **Paul Flowers**, Duesseldorf (DE);  
**Patrick Speck**, Duesseldorf (DE)

(73) Assignee: **Grohe AG**, Hemer (DE)

(\*\*) Term: **14 Years**

(21) Appl. No.: **29/338,666**

(22) Filed: **Jun. 16, 2009**

(30) **Foreign Application Priority Data**

Dec. 16, 2008 (EM) ..... 001057483-0001  
Dec. 16, 2008 (EM) ..... 001057483-0002

(51) **LOC (9) Cl.** ..... **23-01**

(52) **U.S. Cl.** ..... **D23/213**

(58) **Field of Classification Search** ..... D23/213,  
D23/229-230, 223; 239/461-462, 282-283;  
4/615

See application file for complete search history.

(56) **References Cited**

**U.S. PATENT DOCUMENTS**

D94,146 S \* 12/1934 Isenberg ..... D23/213  
D555,762 S \* 11/2007 Jaeb ..... D23/213  
D567,328 S \* 4/2008 Spangler et al. .... D23/213  
D598,520 S \* 8/2009 Flowers et al. .... D23/213

\* cited by examiner

*Primary Examiner*—Robin V Webster

(74) *Attorney, Agent, or Firm*—Muncy, Geissler, Olds &  
Lowe, PLLC

(57) **CLAIM**

The ornamental design of a showerhead, as shown and described.

**DESCRIPTION**

FIG. 1 is a perspective view of a showerhead according to a first embodiment of the present invention.

FIG. 2 is a front elevational view of the showerhead of FIG. 1.

FIG. 3 is a left side elevational view of the showerhead of FIG. 1.

FIG. 4 is a right side elevational view of the showerhead of FIG. 1.

FIG. 5 is a bottom plan view of the showerhead of FIG. 1.

FIG. 6 is a top plan view of the showerhead of FIG. 1.

FIG. 7 is a rear elevational view of the showerhead of FIG. 1.

FIG. 8 is a perspective view of a showerhead according to a second embodiment of the present invention.

FIG. 9 is a front elevational view of the showerhead of FIG. 8.

FIG. 10 is a left side elevational view of the showerhead of FIG. 8.

FIG. 11 is a right side elevational view of the showerhead of FIG. 8.

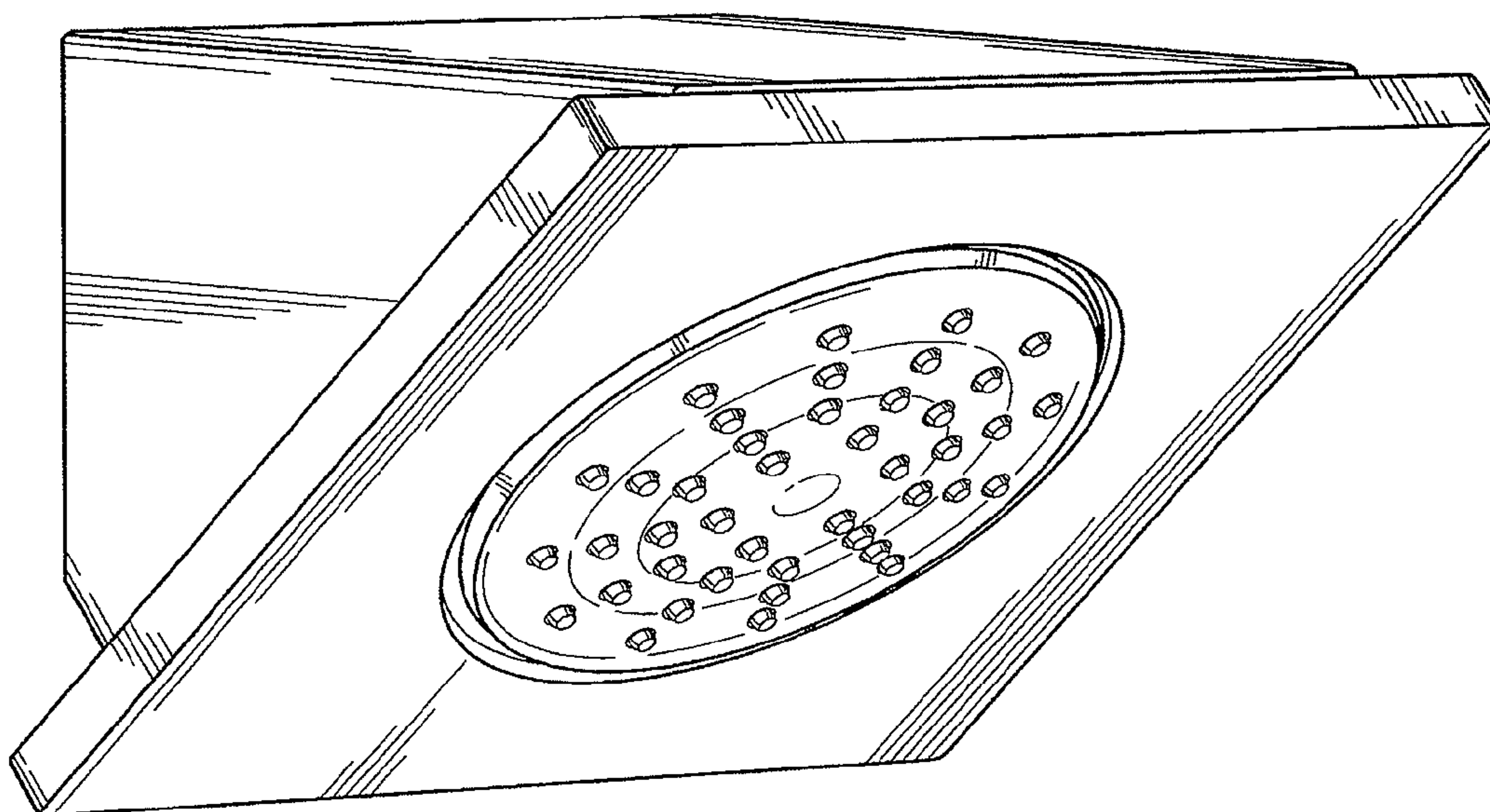
FIG. 12 is a bottom plan view of the showerhead of FIG. 8.

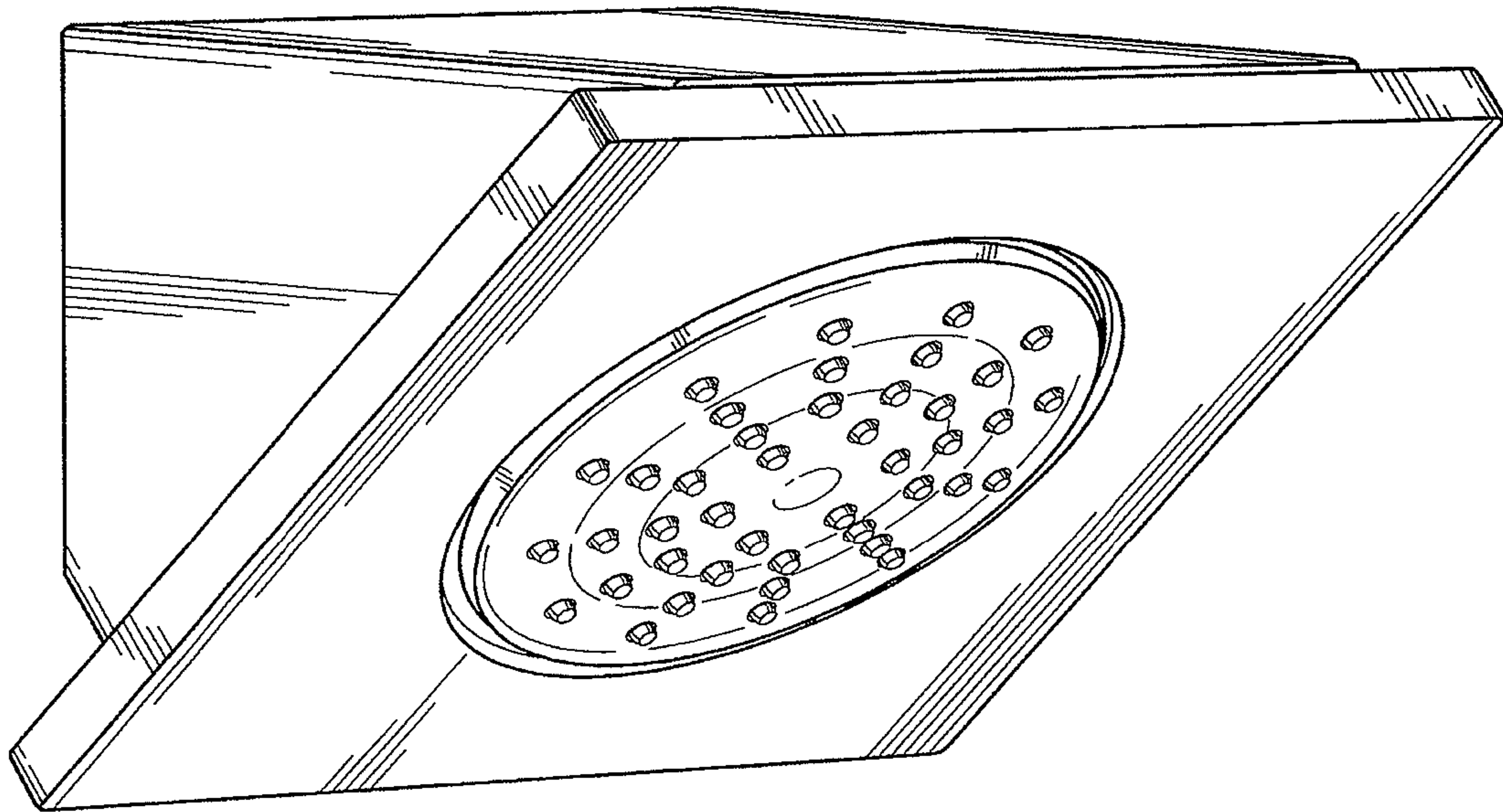
FIG. 13 is a top plan view of the showerhead of FIG. 8; and,

FIG. 14 is a rear elevational view of the showerhead of FIG. 8.

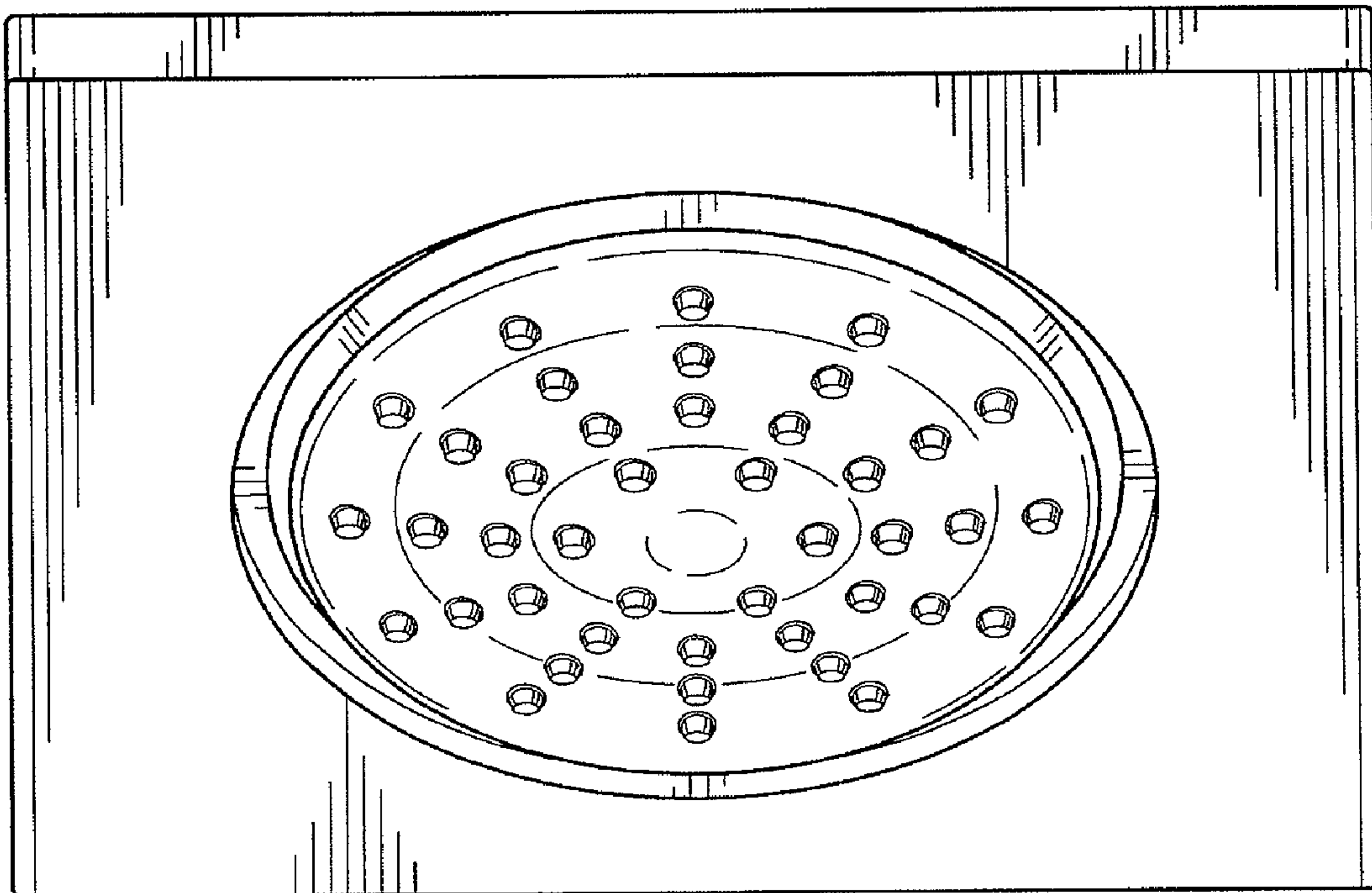
The dashed lines illustrate environment that does not form a part of the present invention, and no claim is made to the material illustrated with dashed lines.

**1 Claim, 14 Drawing Sheets**

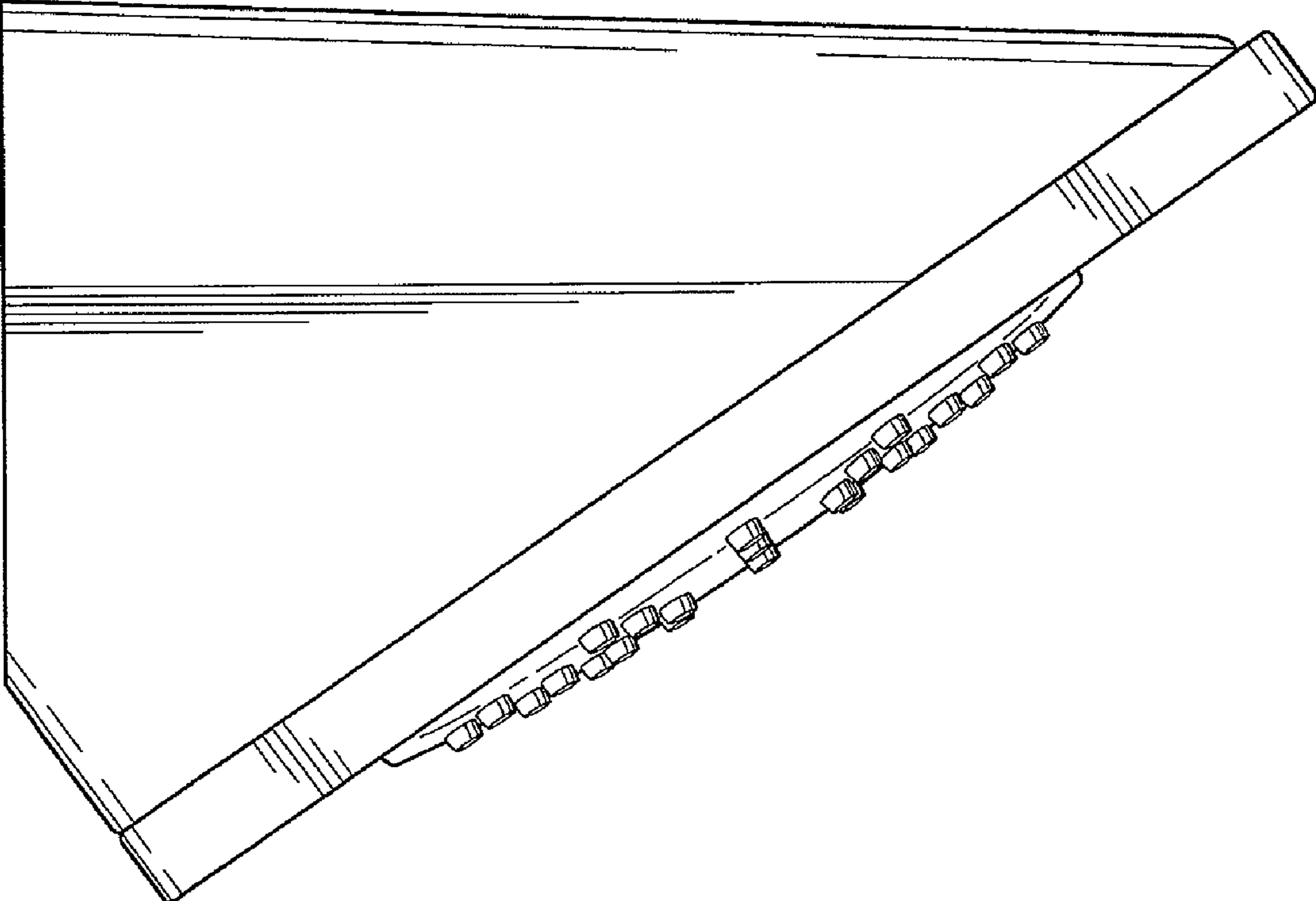




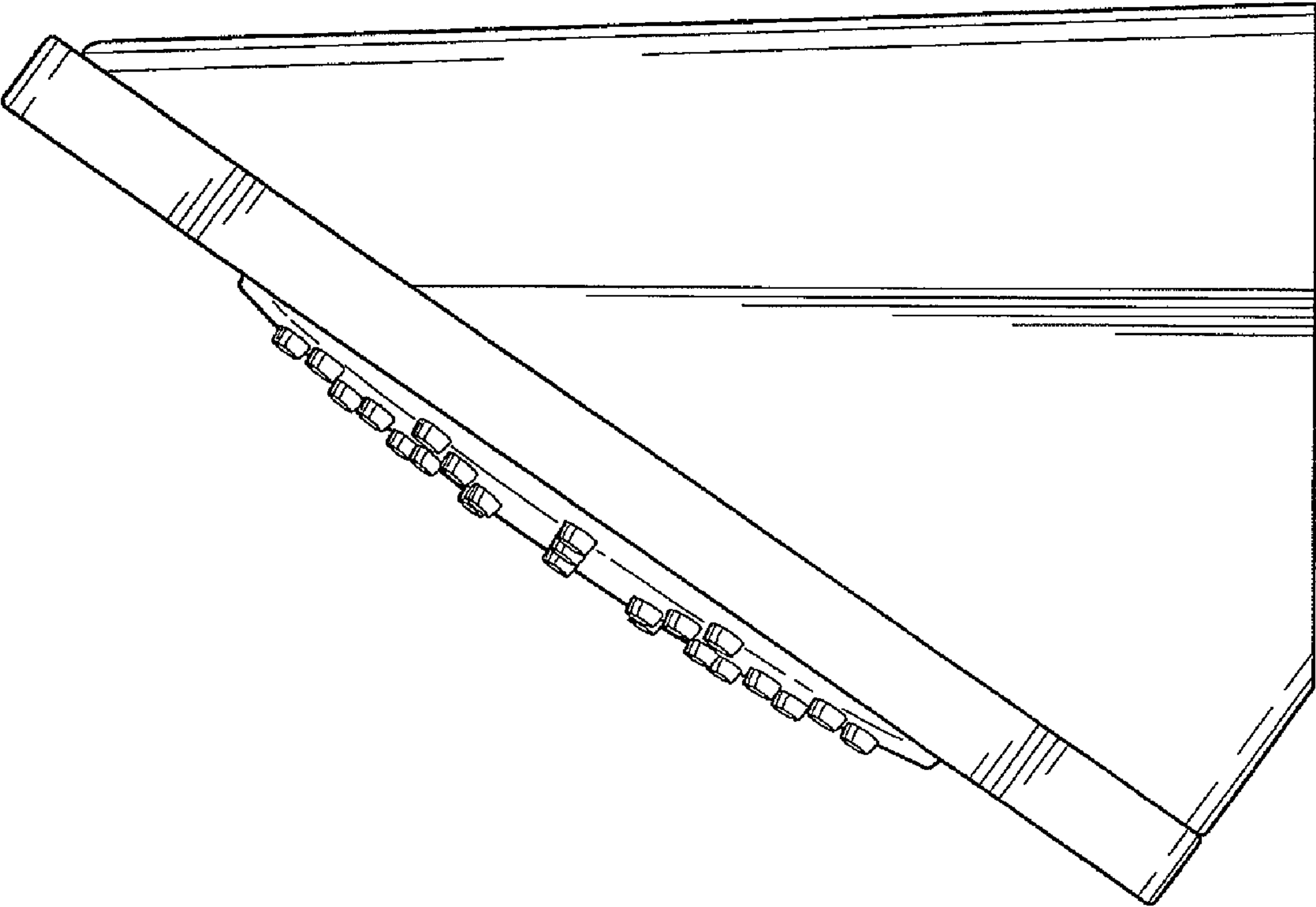
**FIG. 1**



**FIG. 2**

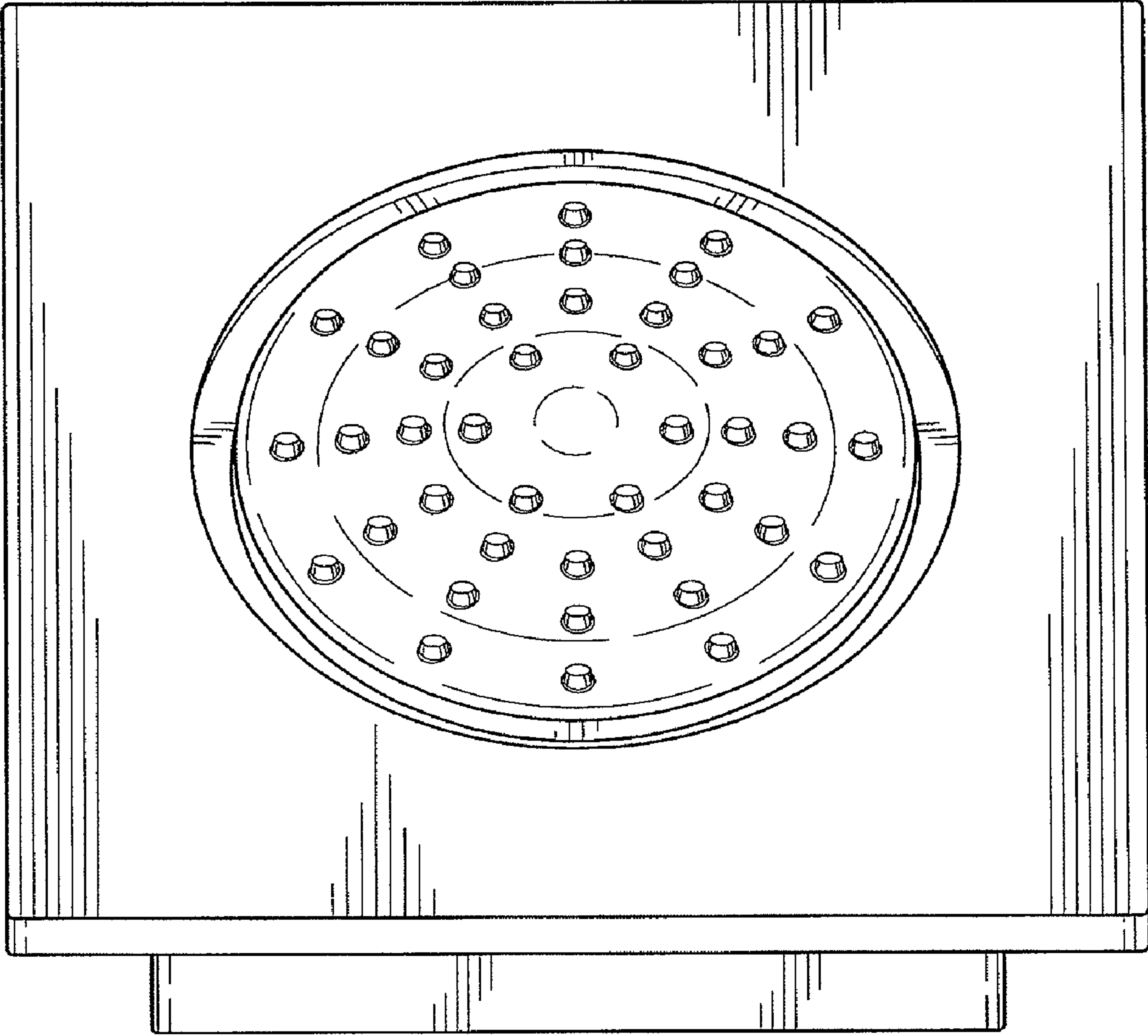


**FIG. 3**

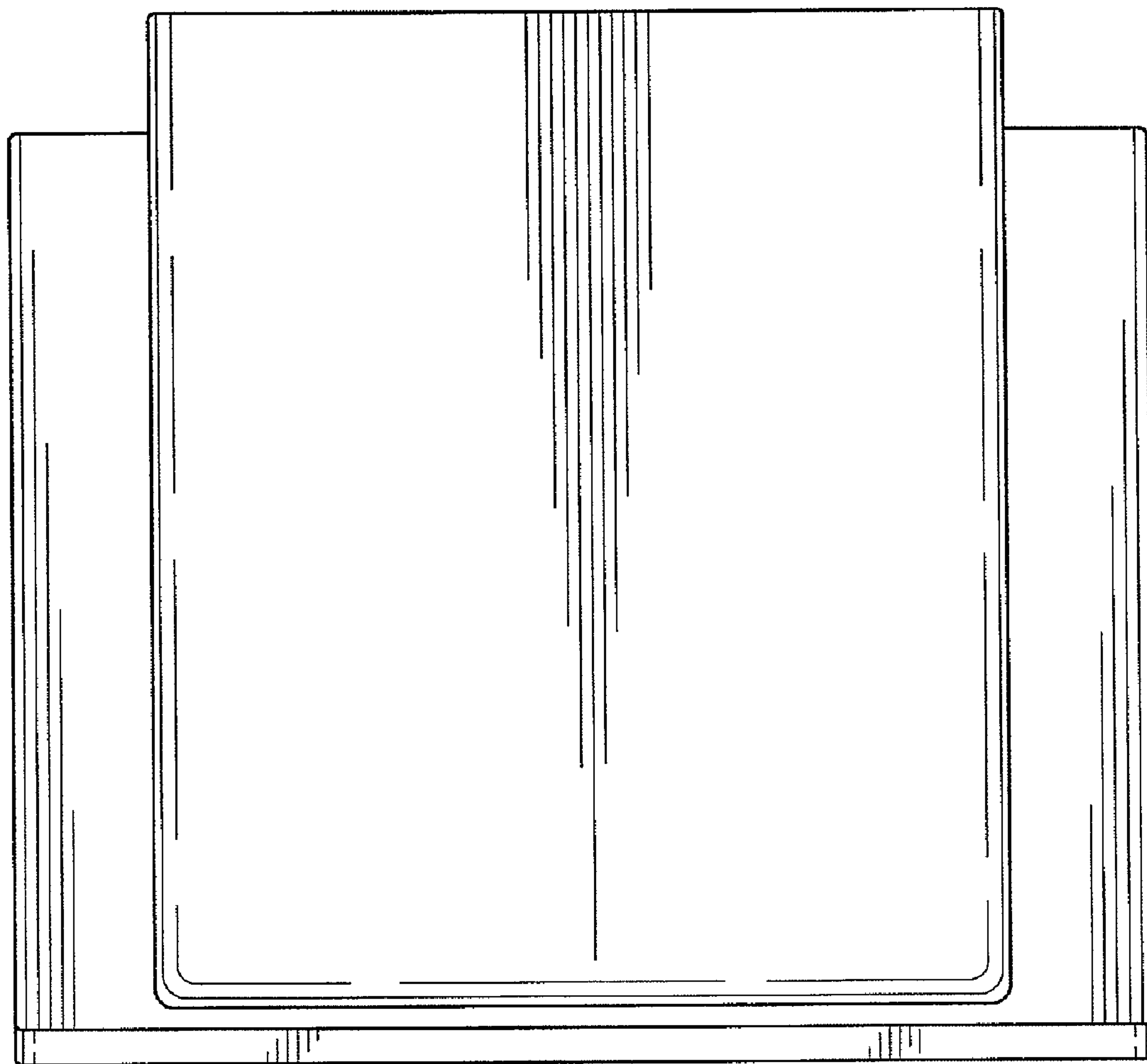


**FIG. 4**

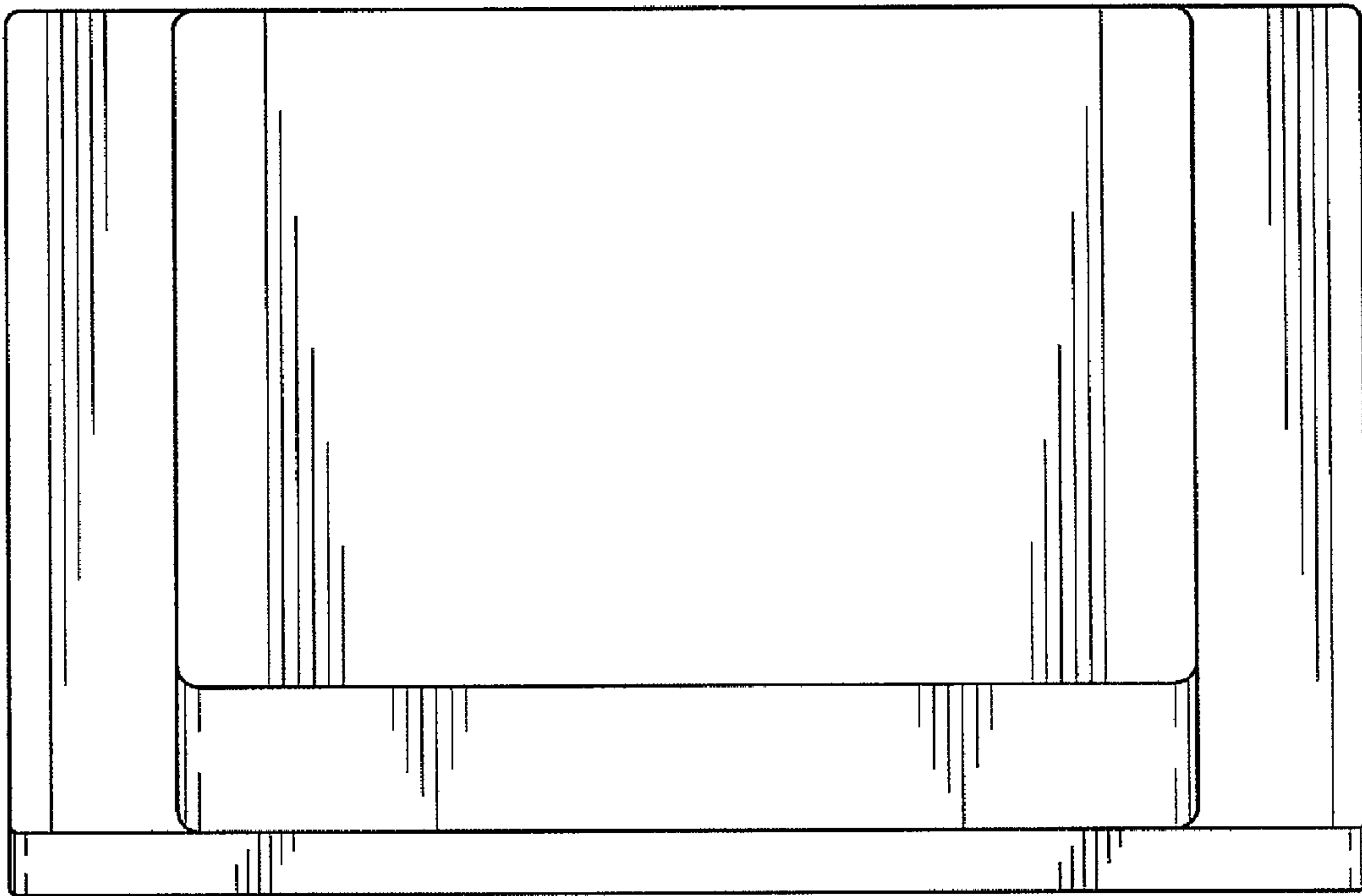




**FIG. 5**

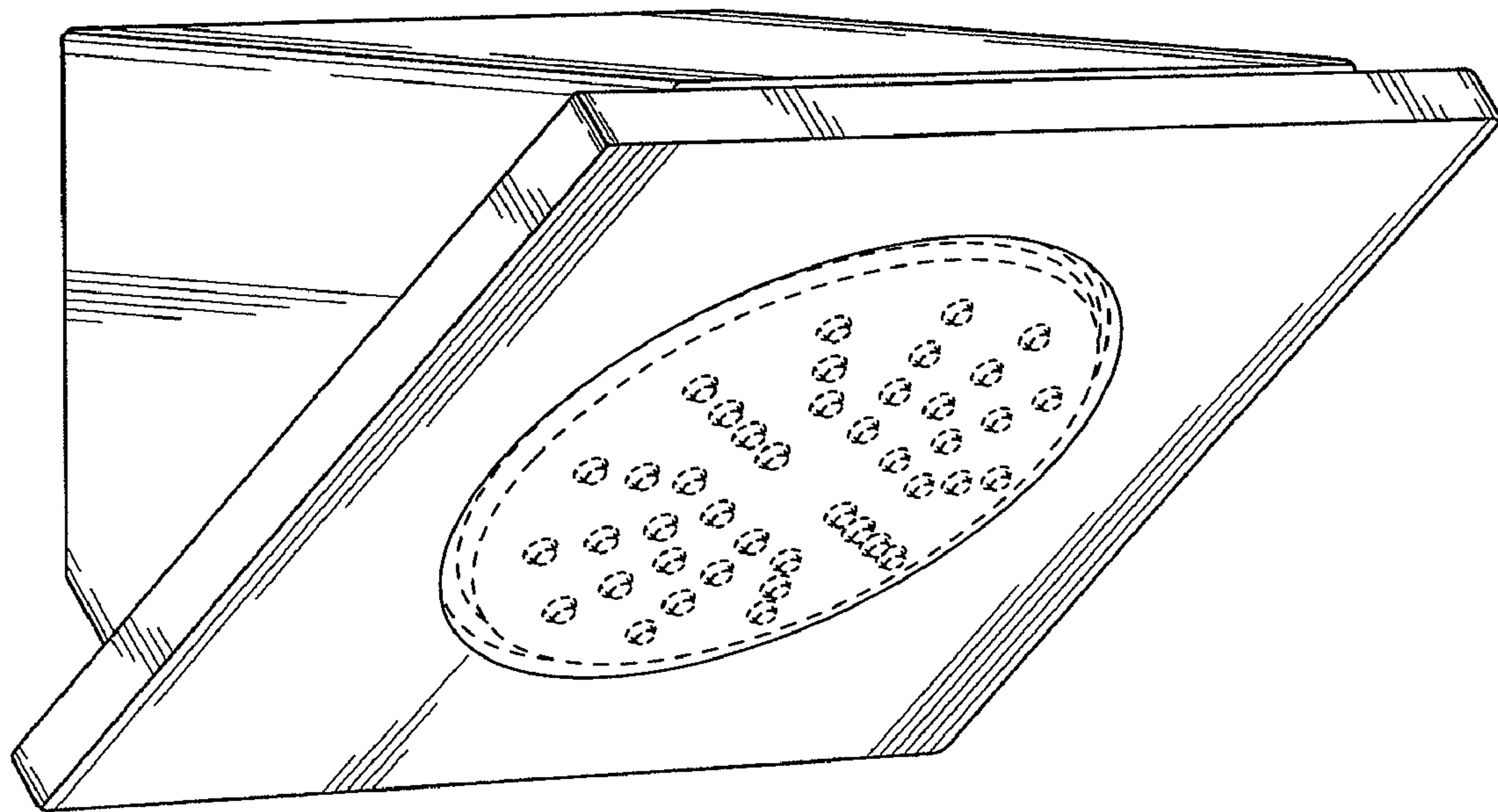


**FIG. 6**

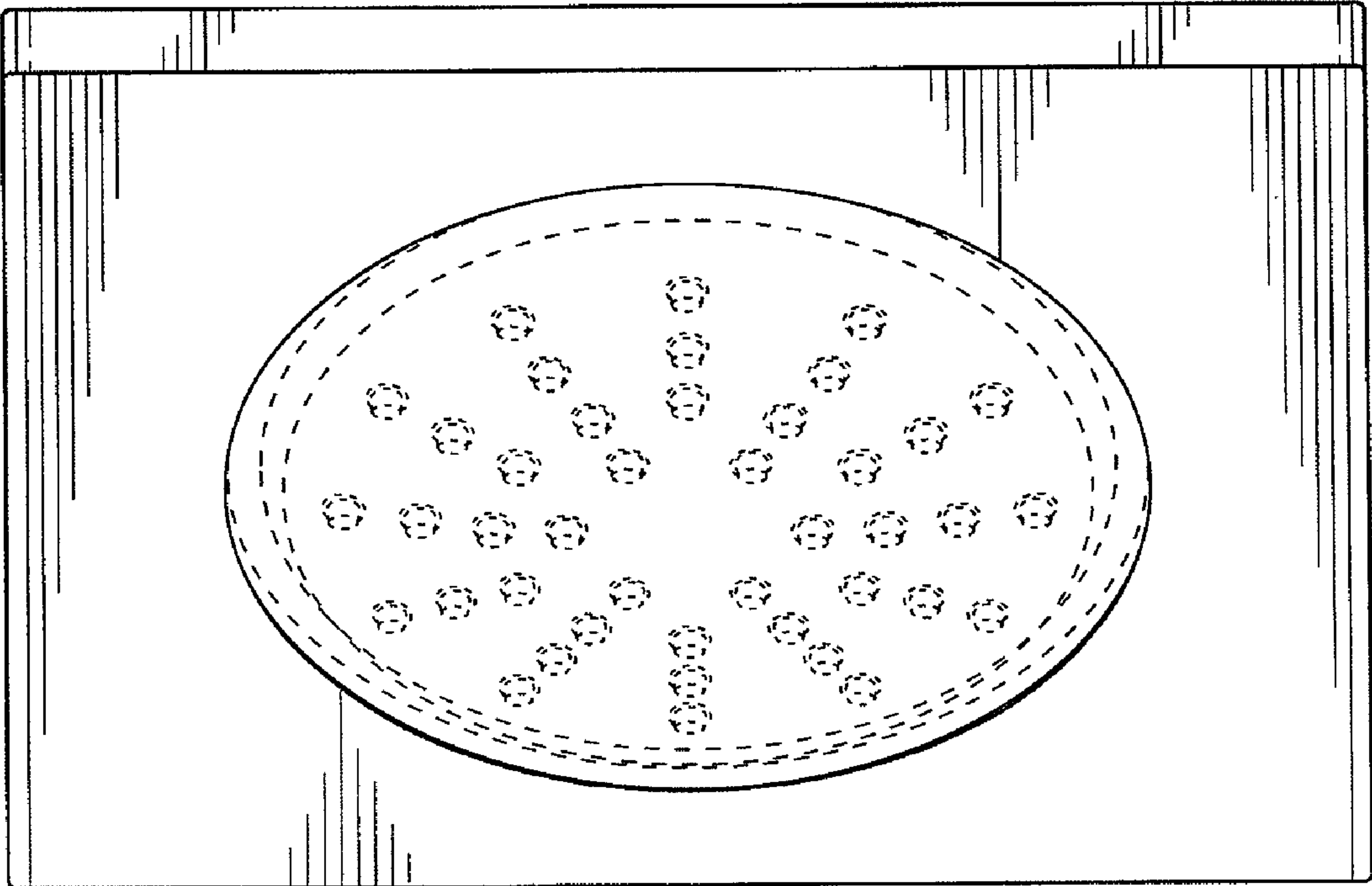


**FIG. 7**

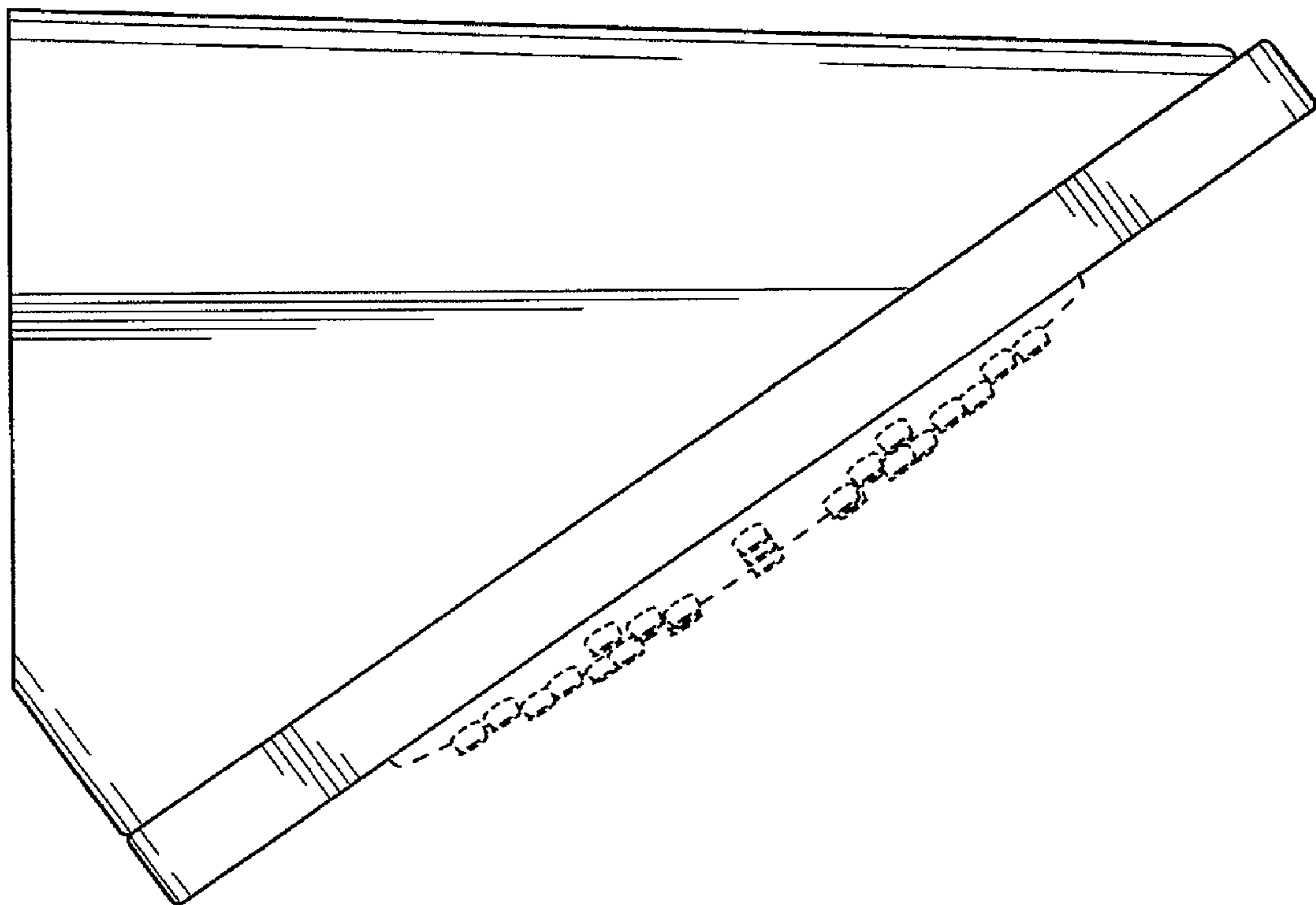




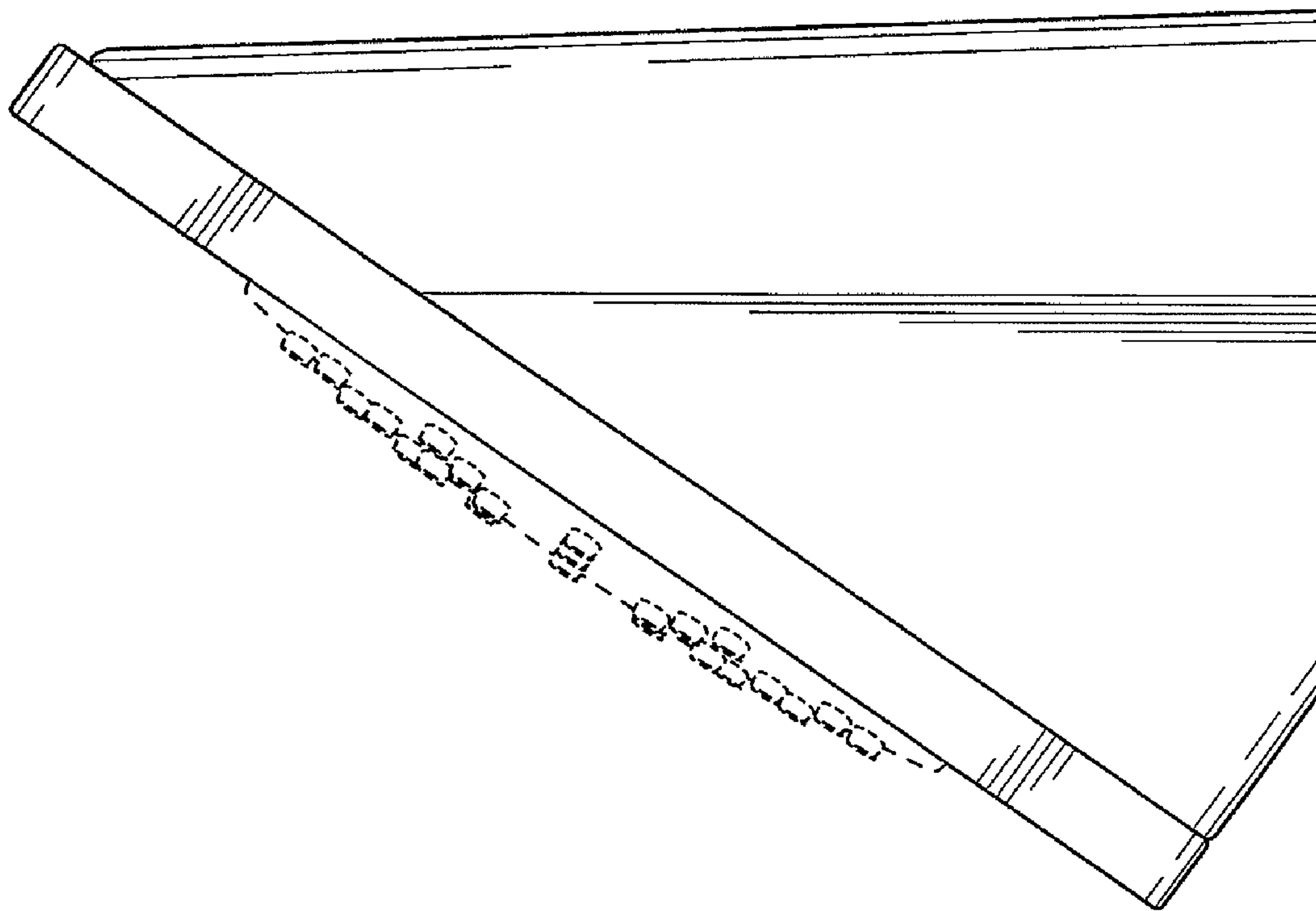
**FIG. 8**



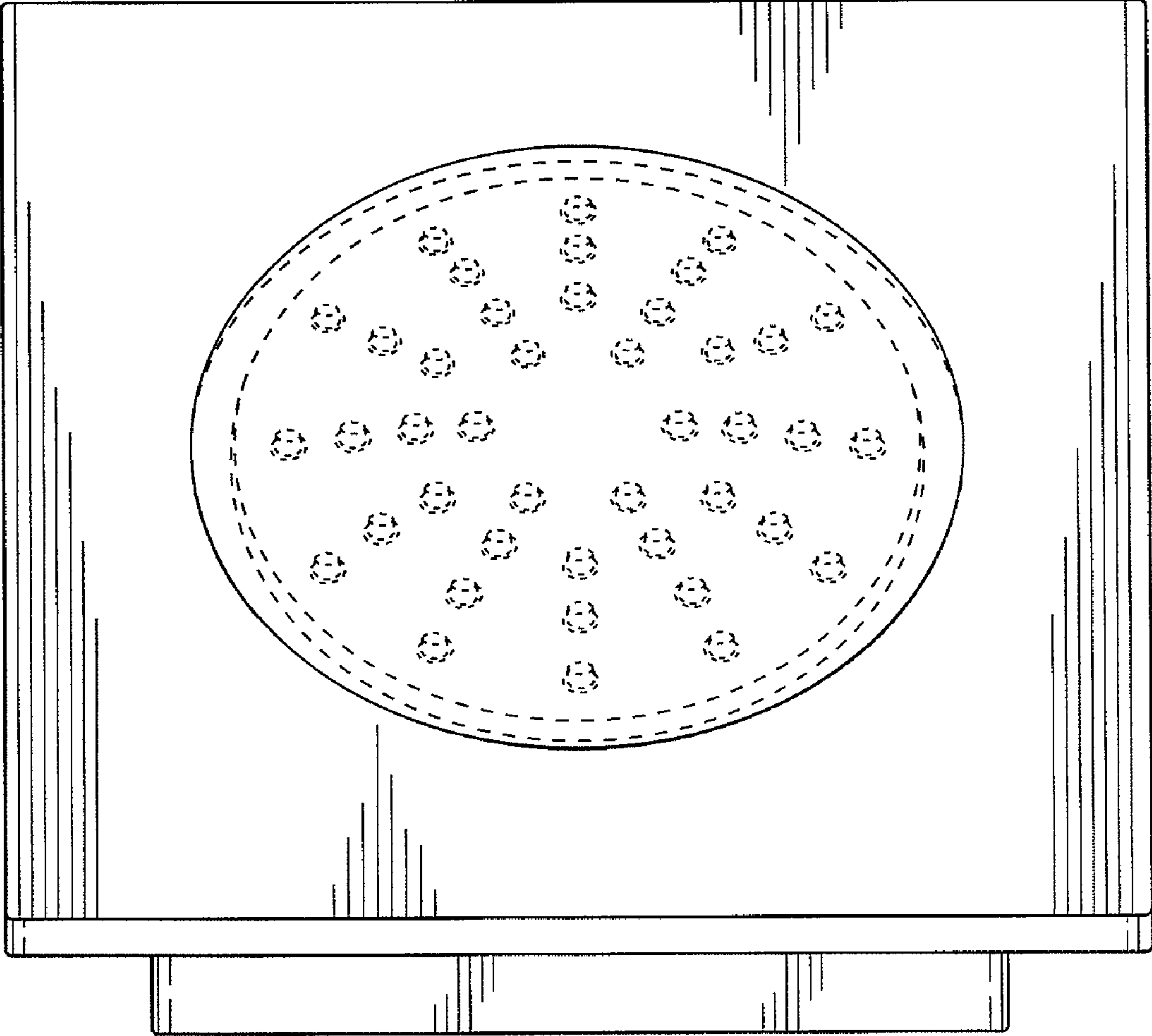
**FIG. 9**



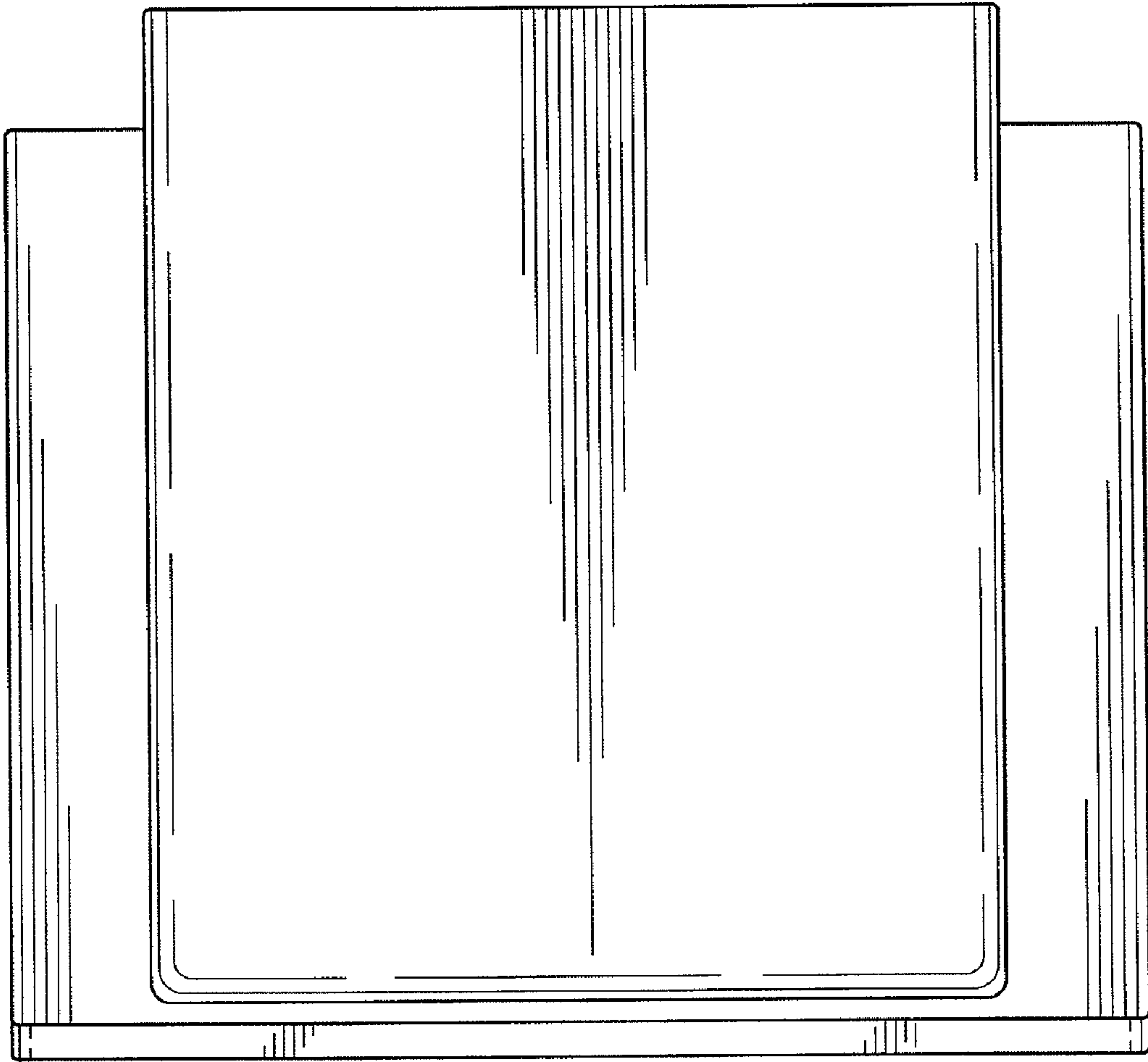
**FIG. 10**



**FIG. 11**

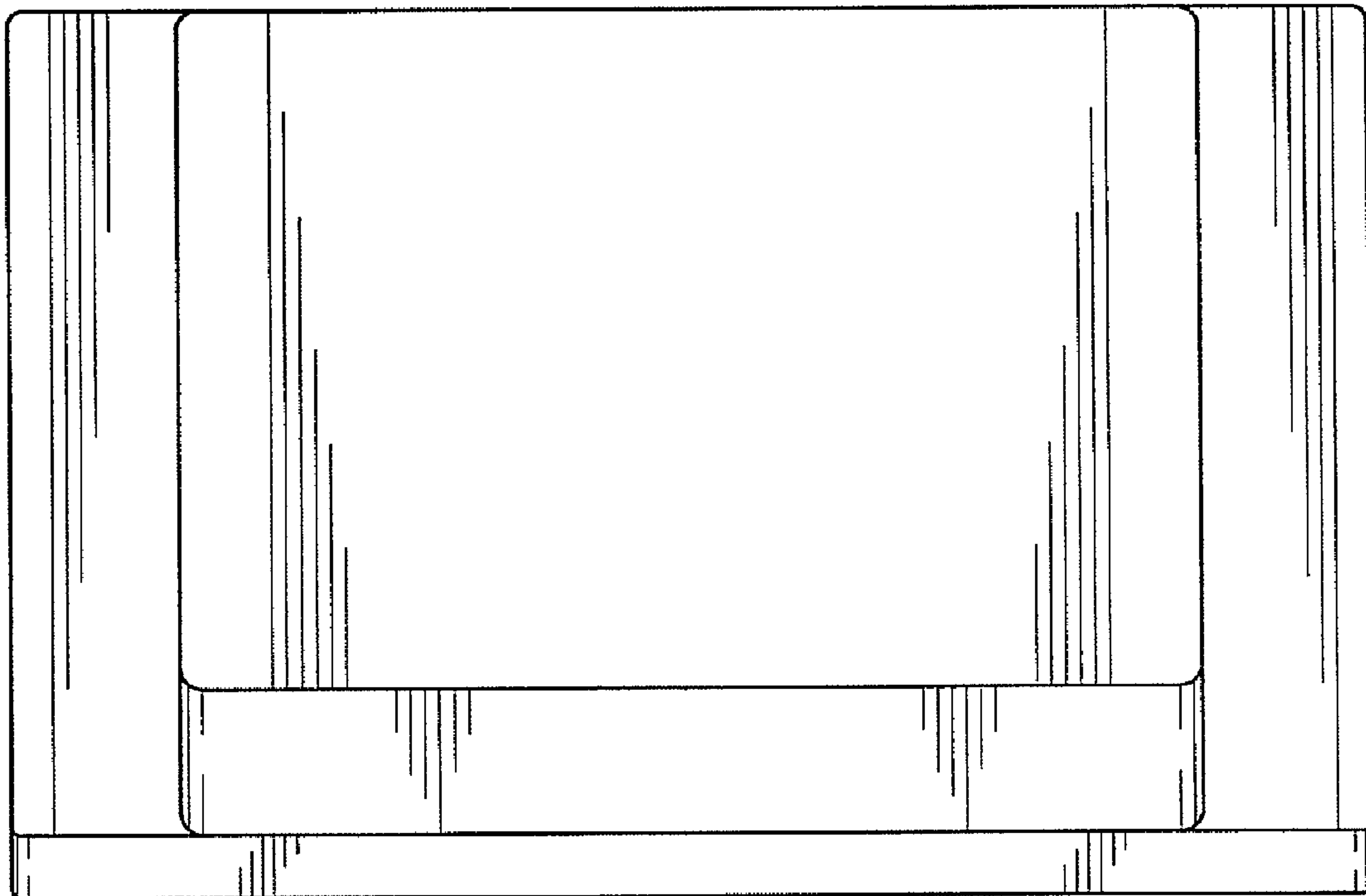


**FIG. 12**



**FIG. 13**





**FIG. 14**