



US00D612437S

(12) **United States Design Patent**  
**Fenster**

(10) **Patent No.:** **US D612,437 S**

(45) **Date of Patent:** **\*\* Mar. 23, 2010**

(54) **EXERCISE APPARATUS**

(75) Inventor: **Mrako A. Fenster**, Madison, WI (US)

(73) Assignee: **Johnson Health Tech Co., Ltd.**,  
Taichung Hsien (TW)

(\*\*) Term: **14 Years**

(21) Appl. No.: **29/314,057**

(22) Filed: **Mar. 3, 2009**

(51) **LOC (9) Cl.** ..... **21-02**

(52) **U.S. Cl.** ..... **D21/694; D21/675**

(58) **Field of Classification Search** ..... D21/662-677,  
D21/680, 686-691, 694, 697; 482/51-52,  
482/57-59, 61-65, 70, 97, 99, 100  
See application file for complete search history.

(56) **References Cited**

**U.S. PATENT DOCUMENTS**

5,643,152	A *	7/1997	Simonson	.....	482/100
D428,949	S *	8/2000	Simonson	.....	D21/694
6,142,917	A *	11/2000	Giannelli et al.	.....	482/100
6,152,864	A *	11/2000	Giannelli et al.	.....	482/100
6,254,516	B1 *	7/2001	Giannelli et al.	.....	482/100
6,409,637	B1 *	6/2002	Webber et al.	.....	482/99
D491,238	S *	6/2004	Giannelli et al.	.....	D21/676
D493,854	S *	8/2004	Grider	.....	D21/694

D516,144	S *	2/2006	Panatta	.....	D21/676
D523,496	S *	6/2006	Grider	.....	D21/694
D574,449	S *	8/2008	Webber et al.	.....	D21/675
2003/0092543	A1 *	5/2003	Giannelli	.....	482/100
2004/0005967	A1 *	1/2004	Panatta	.....	482/100

\* cited by examiner

*Primary Examiner*—Philip S Hyder  
*Assistant Examiner*—Susan E Krakower

(57) **CLAIM**

The ornamental design for a exercise apparatus, as shown and described.

**DESCRIPTION**

FIG. 1 is a perspective view of our new exercise apparatus; FIG. 2 is a front side elevational view of the exercise apparatus; FIG. 3 is a rear side elevational view of the exercise apparatus; FIG. 4 is a left elevational view of the exercise apparatus; FIG. 5 is a right elevational view of the exercise apparatus; FIG. 6 is a top plan view of the exercise apparatus; and, FIG. 7 is another perspective view of the exercise apparatus. The broken lines in the drawings depict unclaimed environmental subject matter.

**1 Claim, 7 Drawing Sheets**

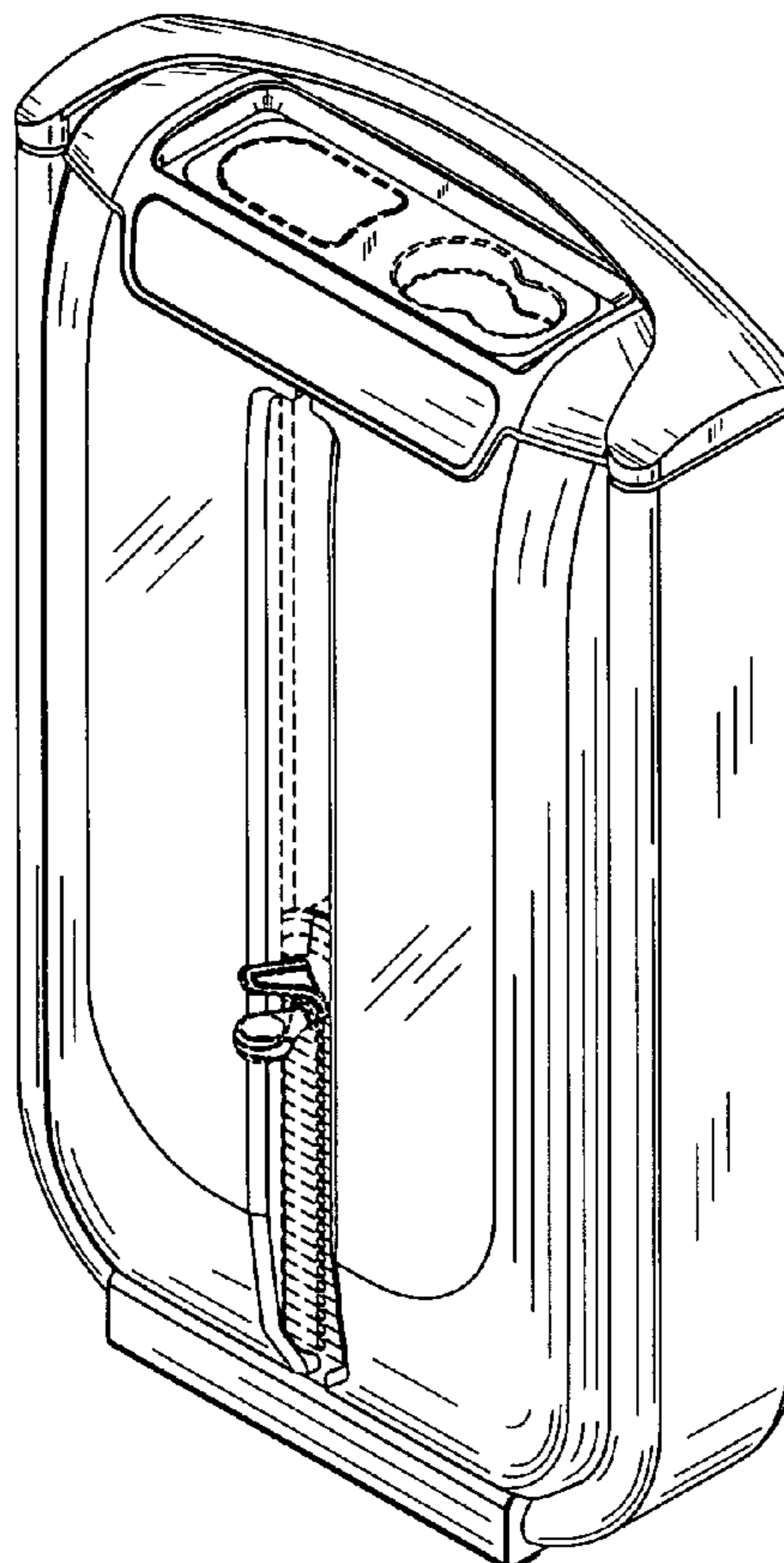

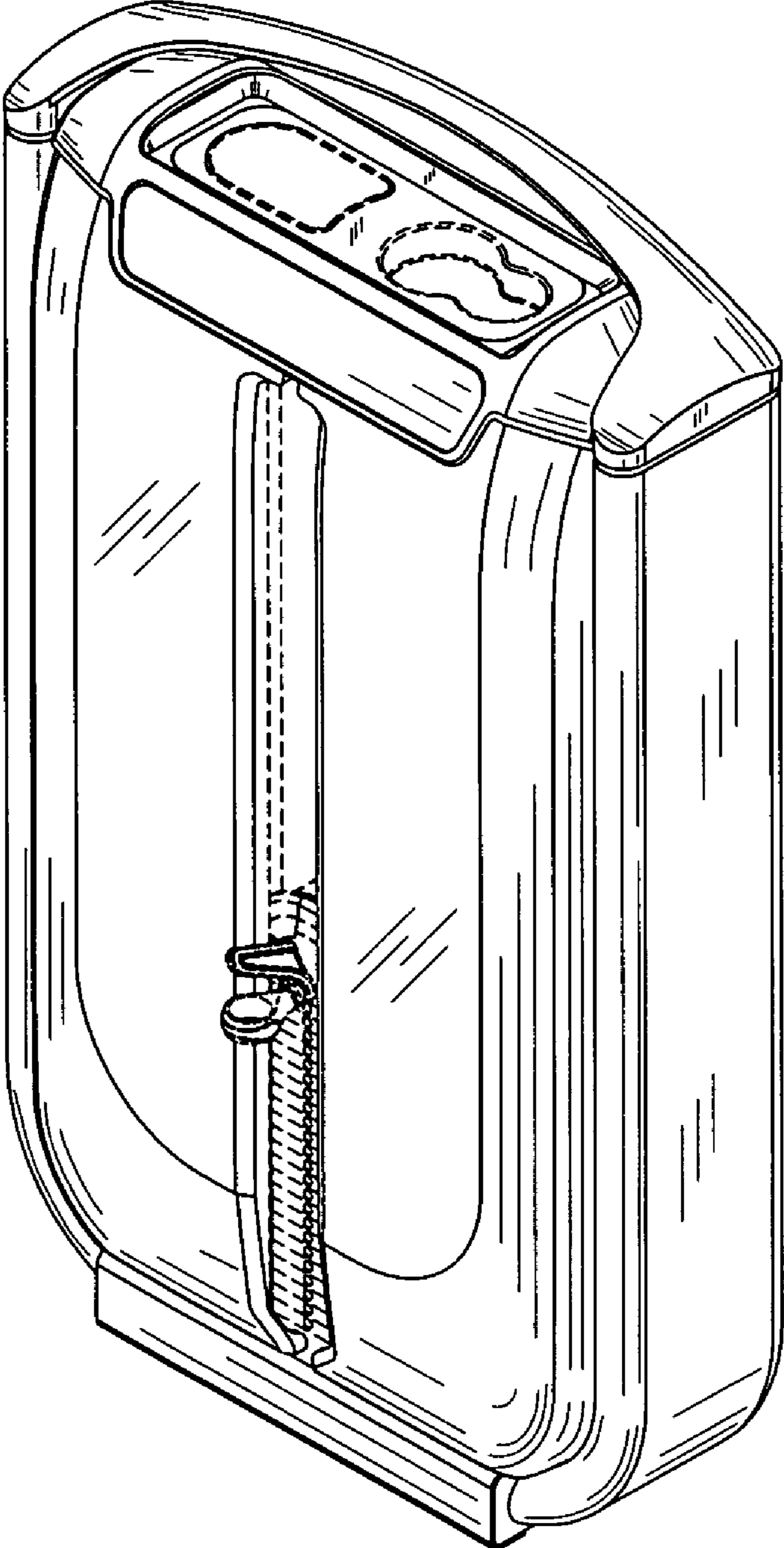

Fig. 1

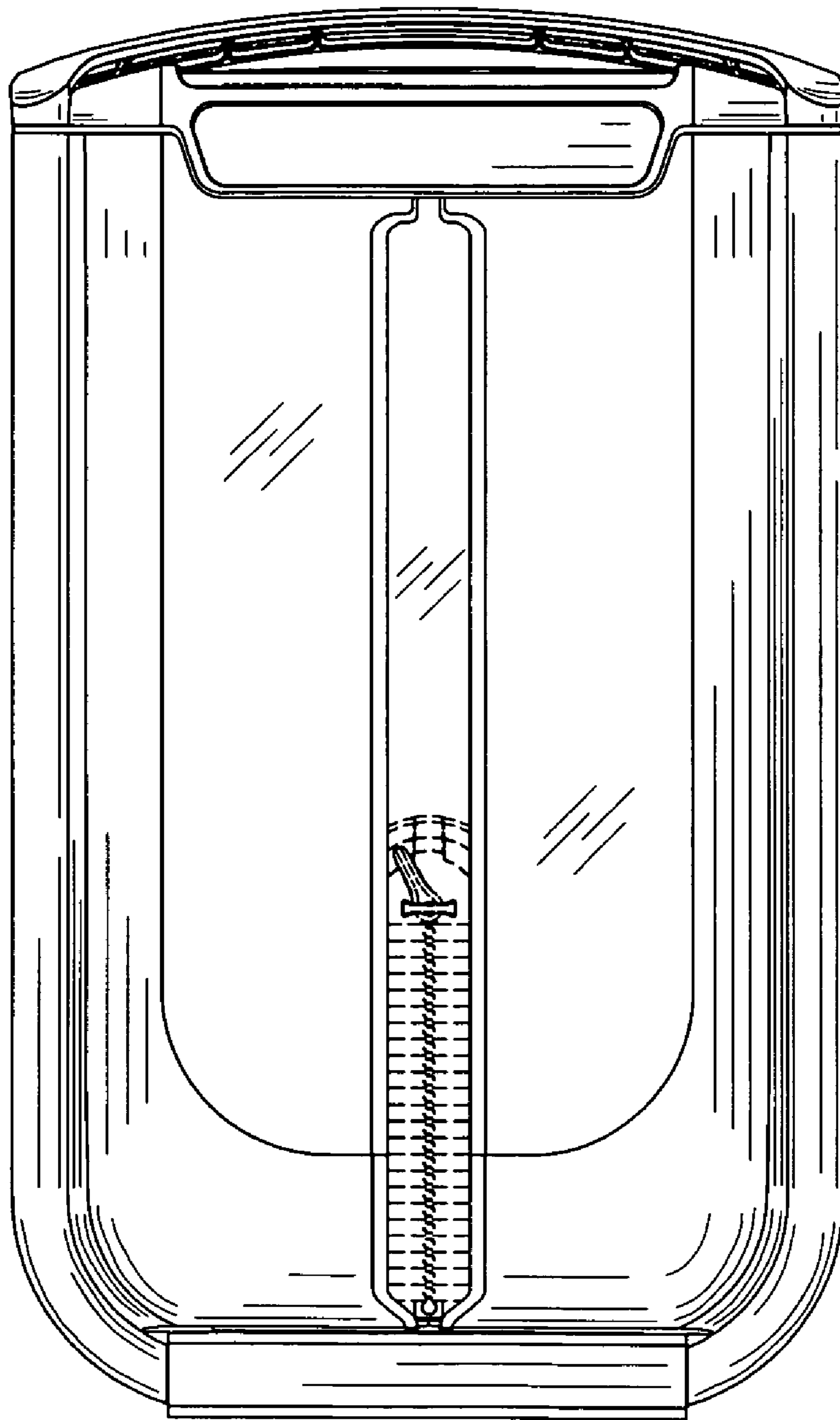

Fig. 2

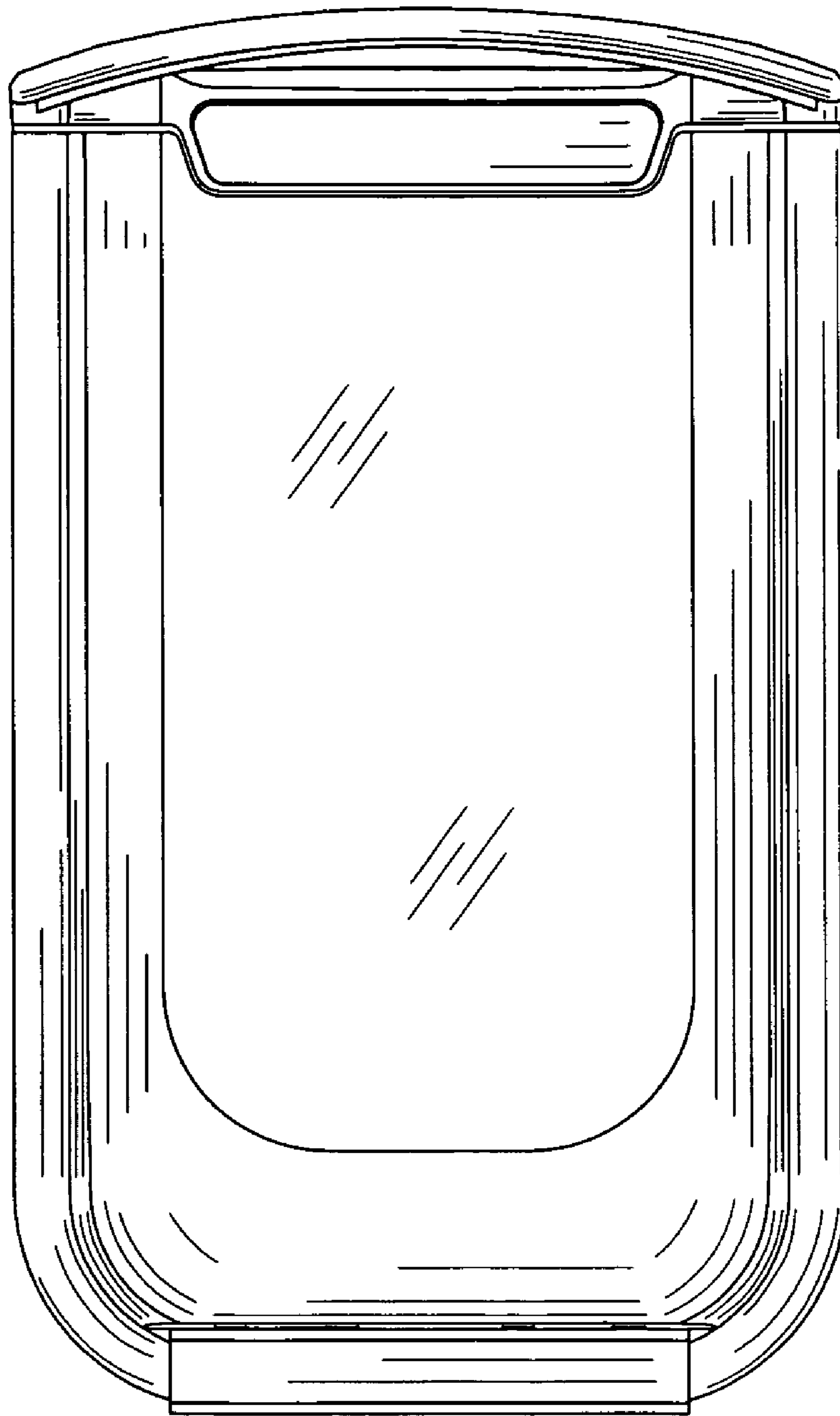

Fig. 3

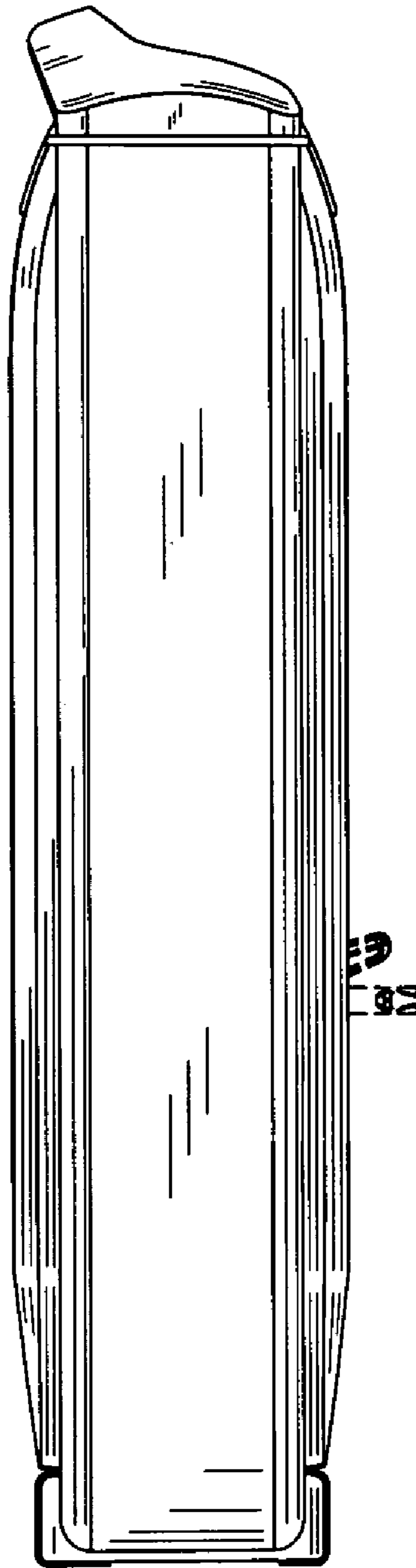

Fig. 4

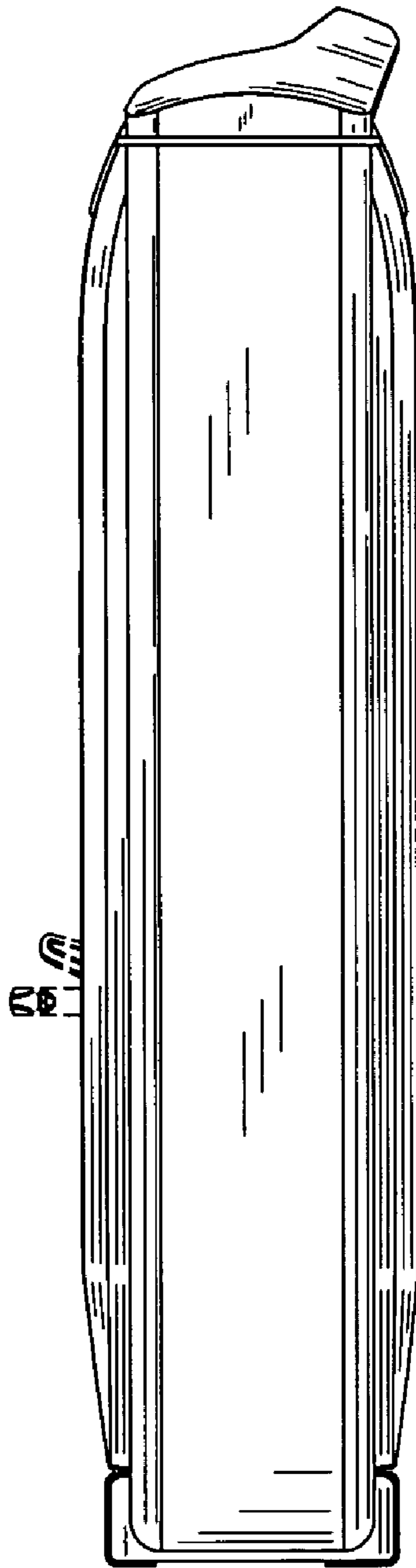

Fig. 5

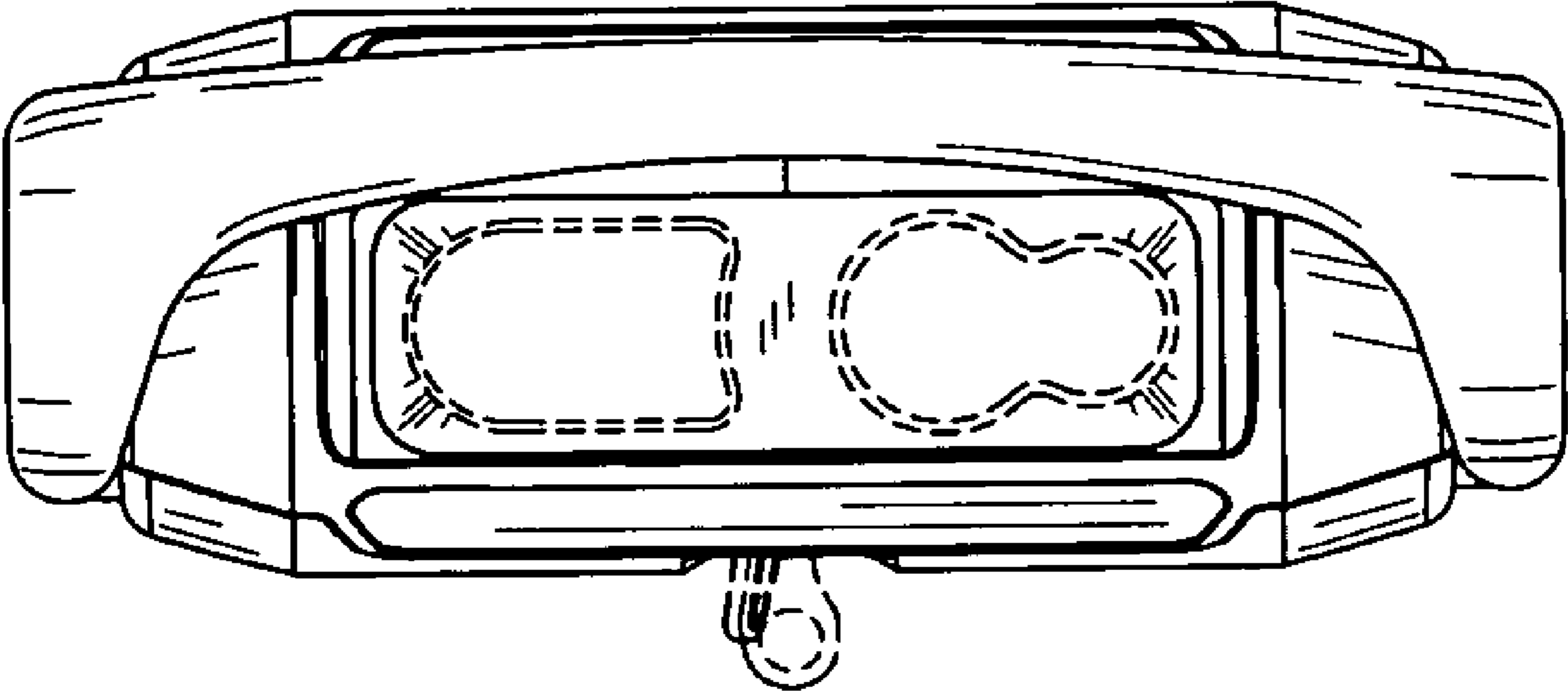

Fig. 6

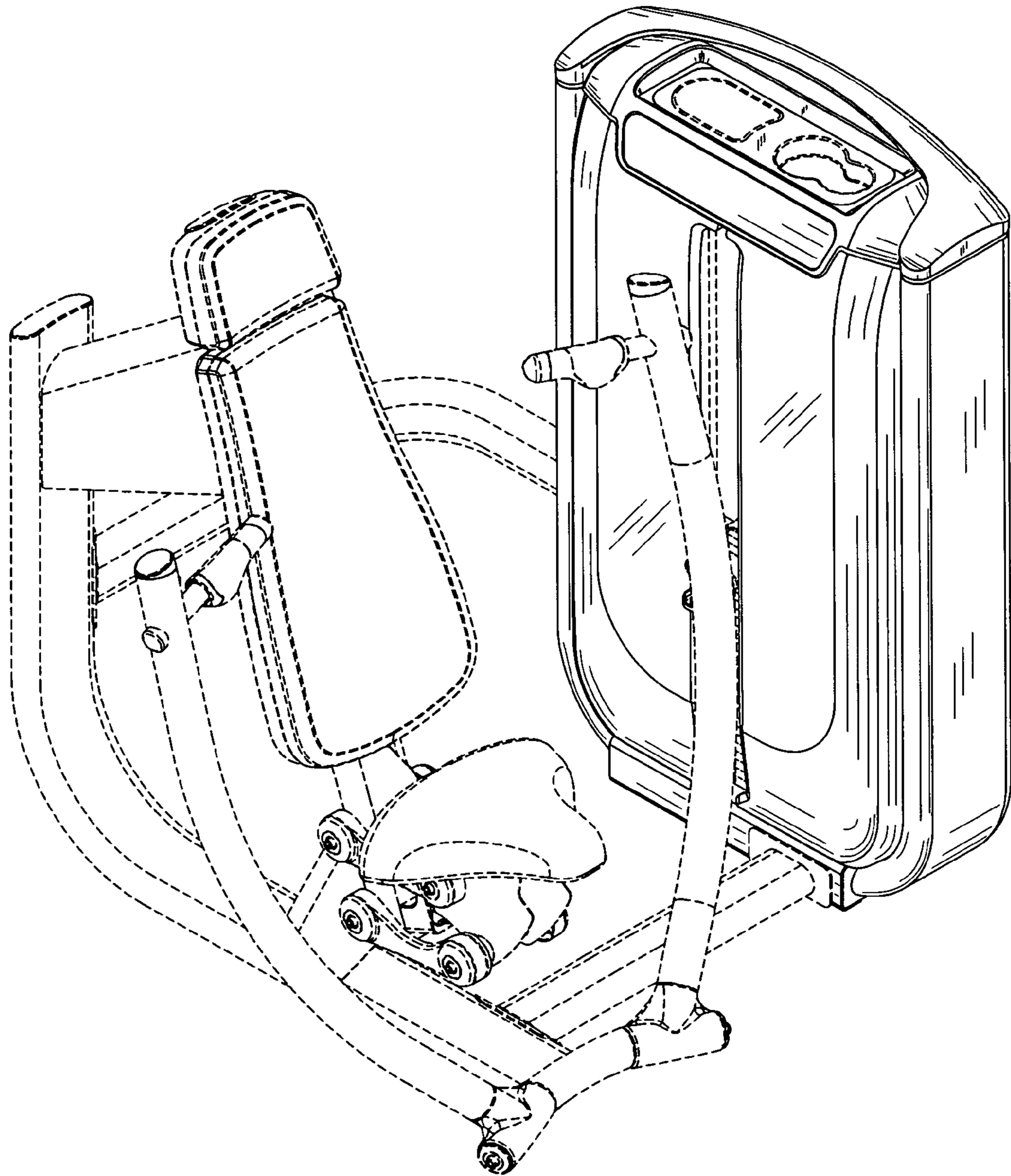

Fig. 7