



US00D612380S

(12) **United States Design Patent**
Ferrari et al.

(10) **Patent No.:** **US D612,380 S**
(45) **Date of Patent:** **** Mar. 23, 2010**

(54) **HANDHELD ELECTRONIC DEVICE**

(75) Inventors: **Marco Sixtus Ferrari**, Waterloo (CA);
Roman Peter Rak, Waterloo (CA);
Todd Andrew Wood, Guelph (CA)

(73) Assignee: **Research In Motion Limited**, Waterloo (CA)

(**) Term: **14 Years**

(21) Appl. No.: **29/340,061**

(22) Filed: **Jul. 13, 2009**

Related U.S. Application Data

(63) Continuation of application No. 29/329,845, filed on Dec. 22, 2008, now Pat. No. Des. 599,794.

(51) **LOC (9) Cl.** **14-02**

(52) **U.S. Cl.** **D14/346**

(58) **Field of Classification Search** D14/341-347,
D14/390, 411, 426, 427, 431, 432, 439, 454,
D14/455, 456, 138 R, 138 AA, 138 AB, 138 AC,
D14/138 AD, 138 C, 138 G, 137, 203.7,
D14/203.3, 203.4, 203.5, 203.6, 238.1, 247,
D14/248, 250, 251, 252, 254, 496, 375, 125,
D14/126; D21/329, 330, 331, 333; D18/7;
D10/65; 345/169, 901, 905; 379/433.13,
379/910, 916, 433.04, 433.07, 433.11, 433.12;
455/556.1, 556.2, 566, 575.1, 575.3, 575.4,
455/90.3; D6/308

See application file for complete search history.

(56) **References Cited**

U.S. PATENT DOCUMENTS

D514,590 S * 2/2006 Naruki D14/203.3
D528,542 S * 9/2006 Luminosu et al. D14/346
D567,254 S * 4/2008 Lee D14/496
D593,552 S * 6/2009 Ferrari et al. D14/341
D593,554 S * 6/2009 Griffin et al. D14/346
D599,794 S * 9/2009 Ferrari et al. D14/346
D603,402 S * 11/2009 Ferrari et al. D14/346
D603,404 S * 11/2009 Rak et al. D14/346

D603,405 S * 11/2009 Wood et al. D14/346
D603,406 S * 11/2009 Wood et al. D14/346
D606,538 S * 12/2009 Ferrari et al. D14/346
D606,540 S * 12/2009 Liao et al. D14/346
D606,994 S * 12/2009 Griffin et al. D14/346

FOREIGN PATENT DOCUMENTS

EM 000937024-0006 * 8/2008
EM 001088470-0001 * 3/2009

OTHER PUBLICATIONS

BlackBerry Curve 8900, announced Nov. 2008, viewed on Jan. 11, 2010, http://www.gsmarena.com/blackberry_curve_89002604.php.
Motorola Q 11, announced Oct. 2008, viewed on Jan. 11, 2010, http://www.gsmarena.com/motorola_q_11-2541.php.

* cited by examiner

Primary Examiner—Jennifer Rivard
Assistant Examiner—Angela J Lee

(57) **CLAIM**

We claim the ornamental design for a handheld electronic device, as shown and described.

DESCRIPTION

FIG. 1 is a front perspective view of a handheld electronic device;

FIG. 2 is a back perspective view of the handheld electronic device;

FIG. 3 is a front elevation view thereof;

FIG. 4 is a back elevation view thereof;

FIG. 5 is a right elevation view thereof;

FIG. 6 is a left elevation view thereof;

FIG. 7 is a top plan view thereof; and,

FIG. 8 is a bottom plan view thereof.

The broken lines shown in the drawings of the handheld electronic device are for the purpose of illustrating portions of the article and form no part of the claimed design.

1 Claim, 6 Drawing Sheets

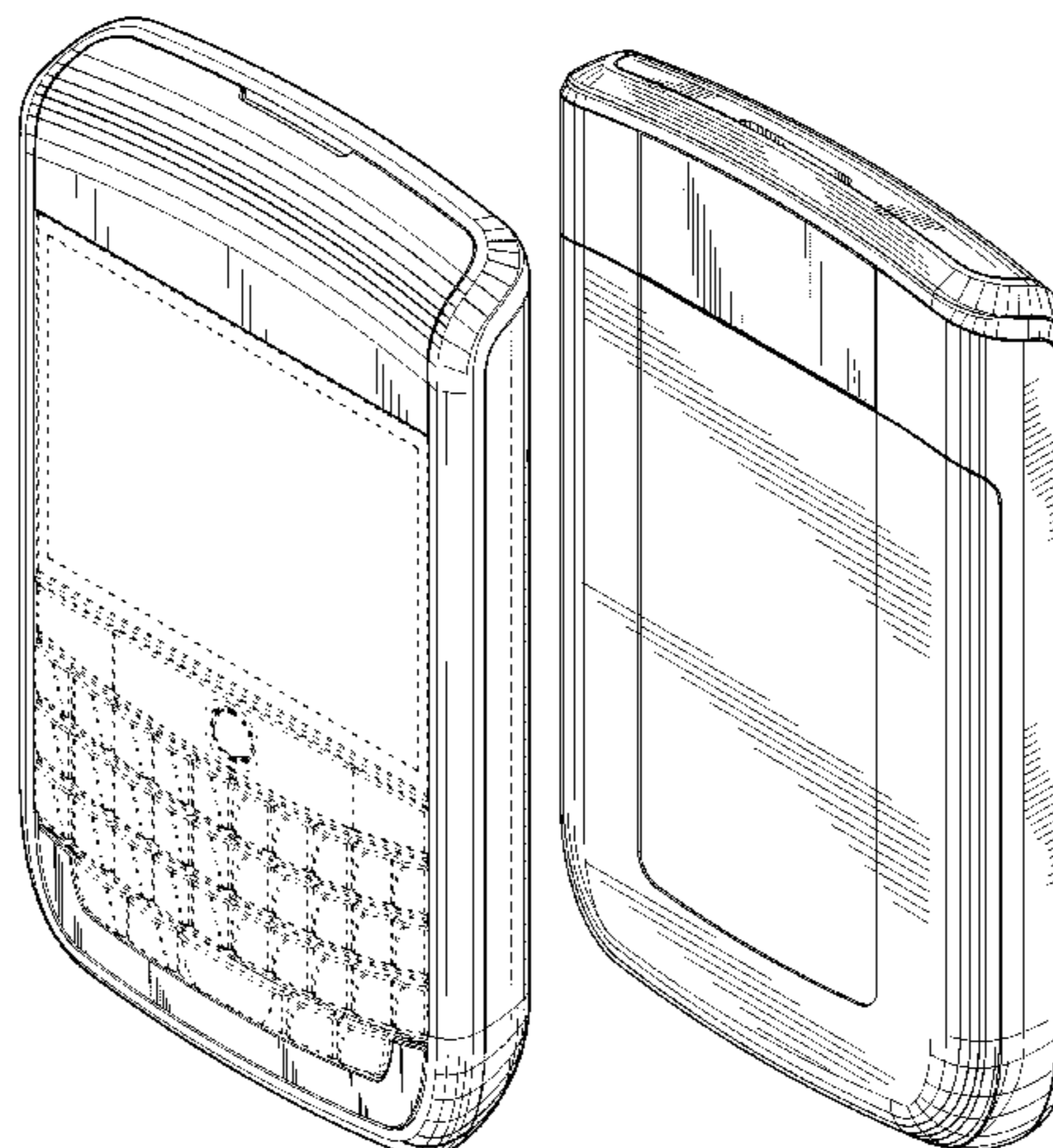

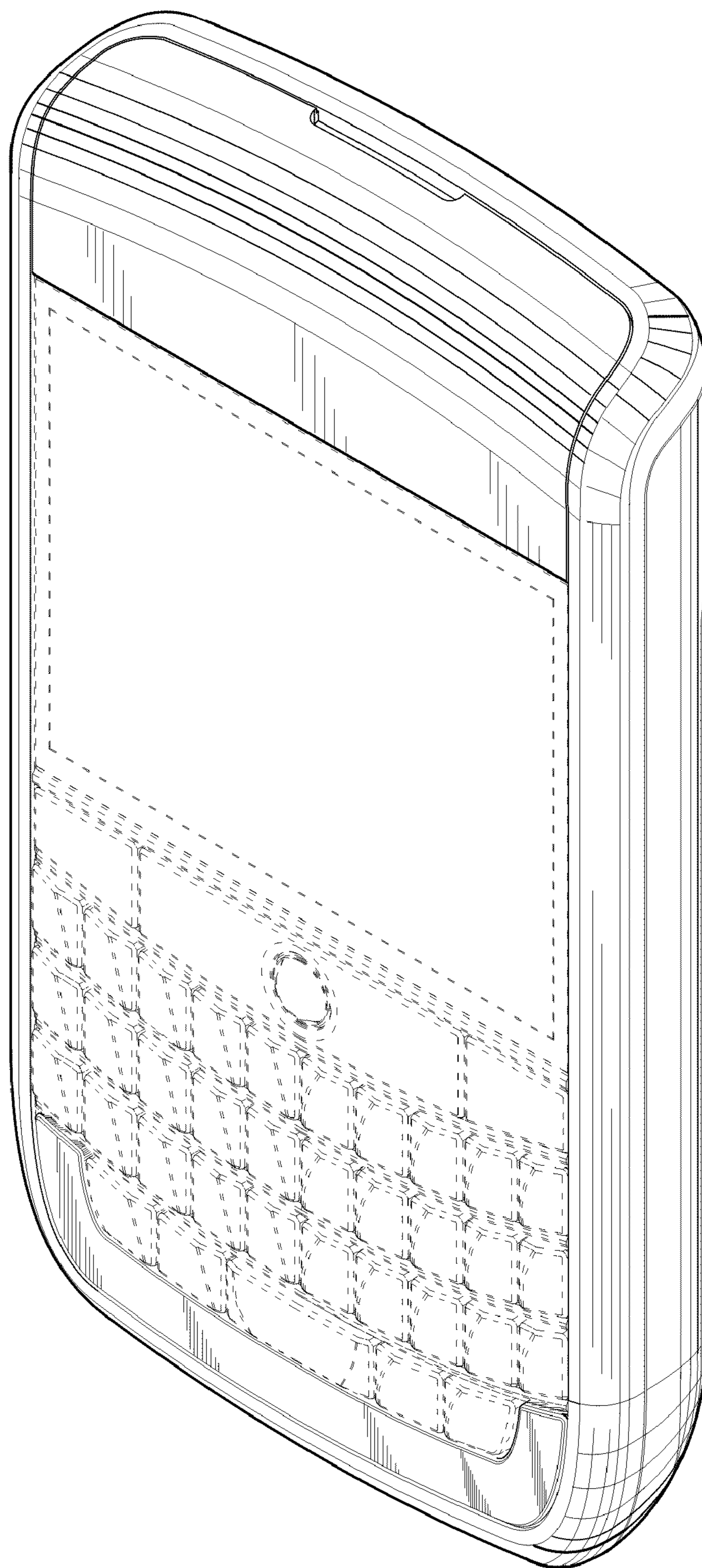

FIG.1

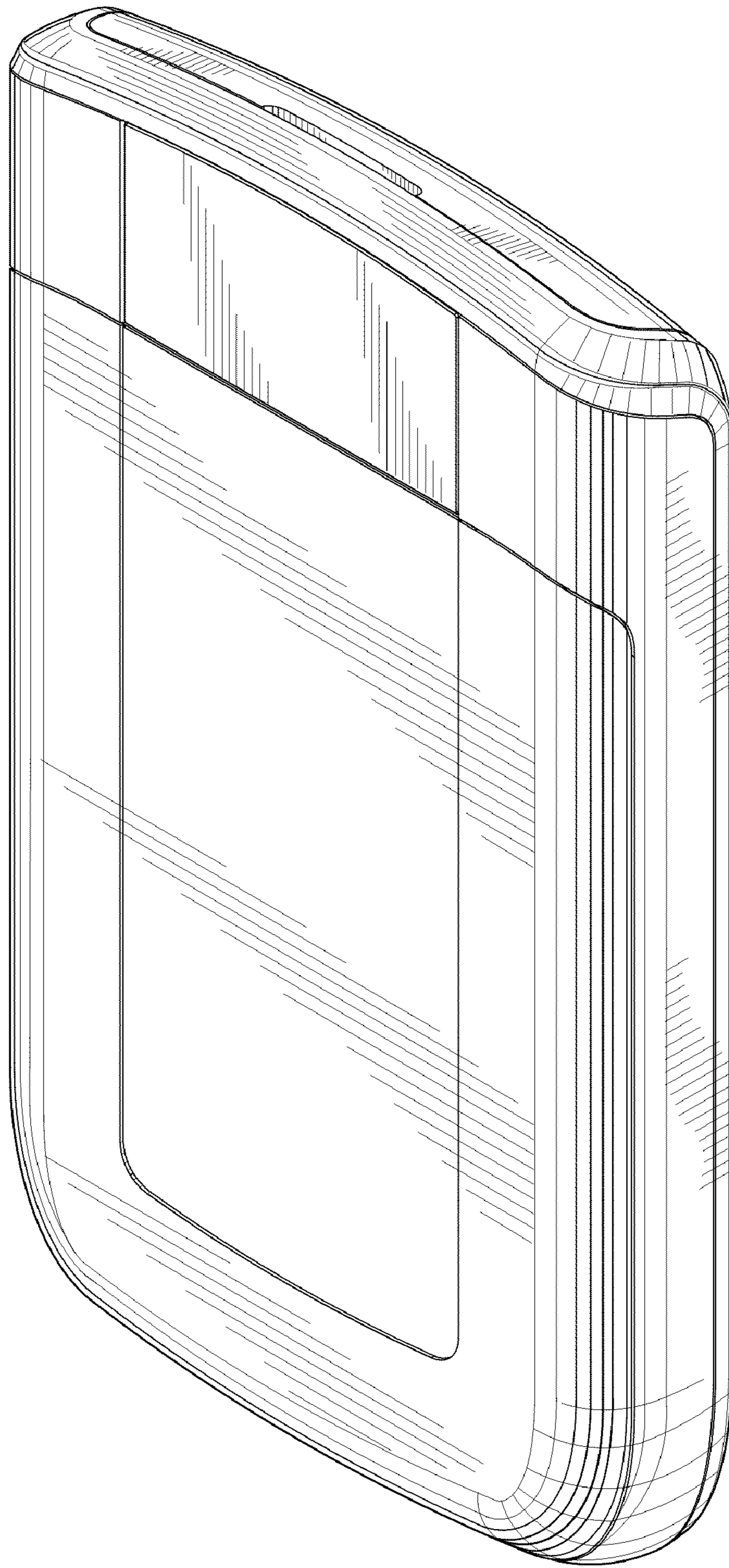

FIG.2

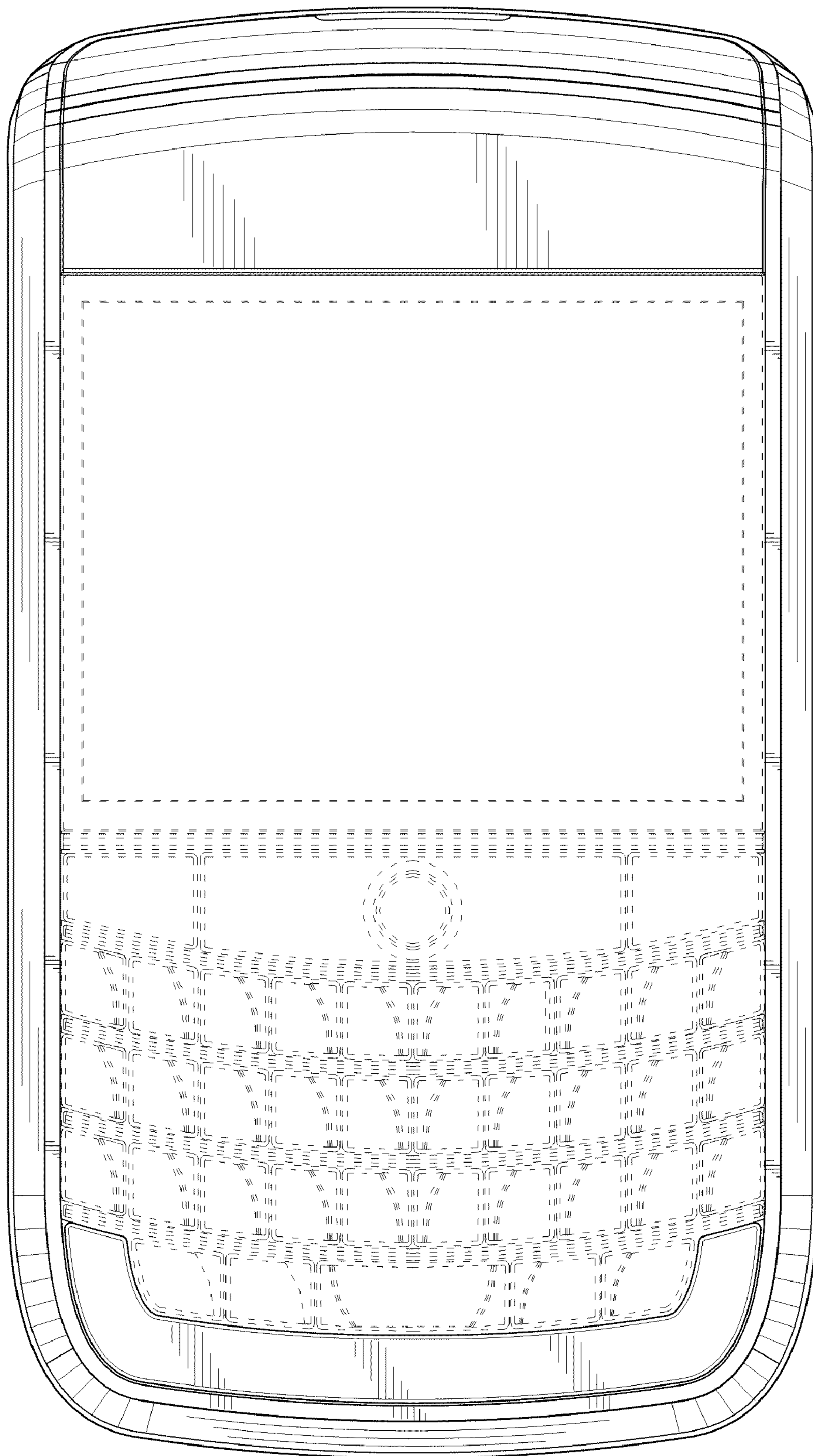

FIG.3

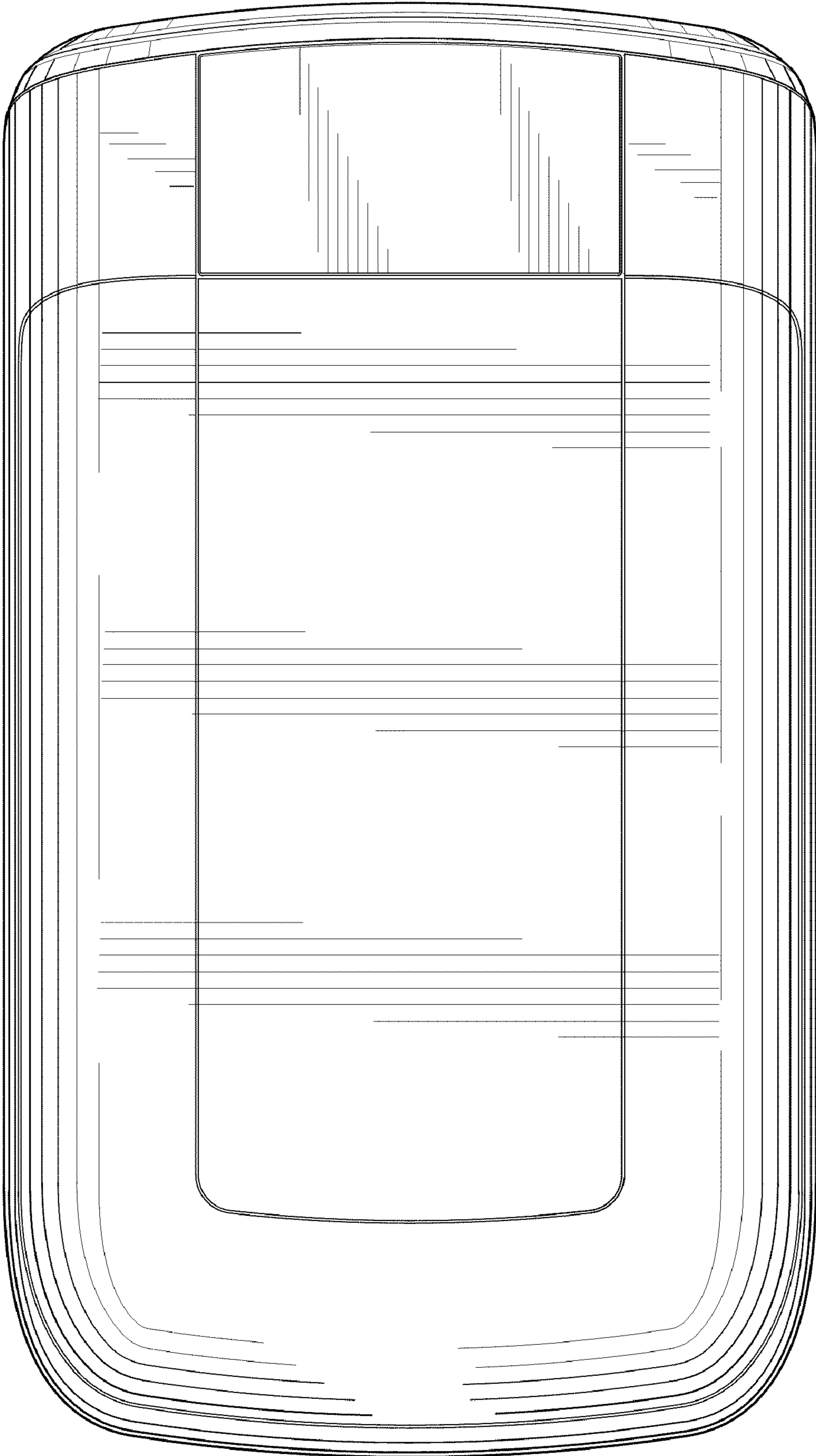

FIG.4

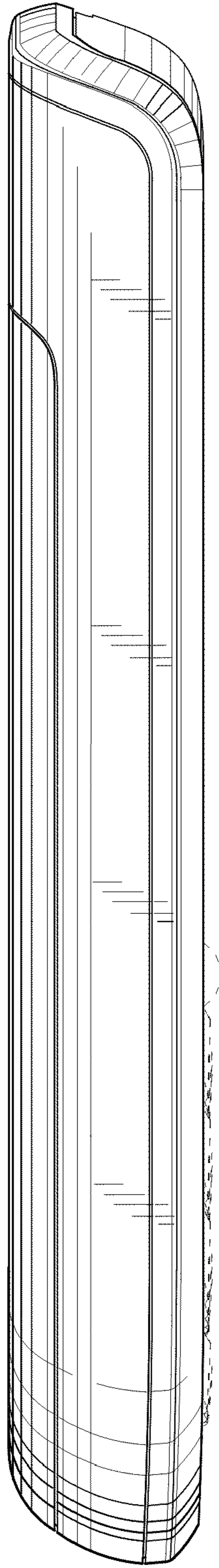

FIG.5

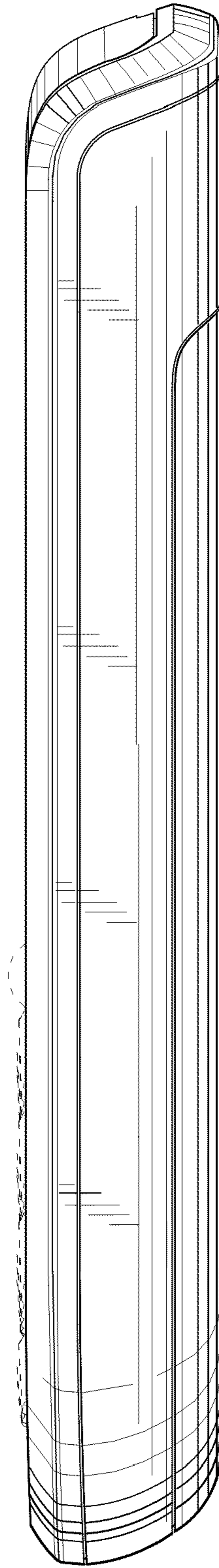

FIG.6

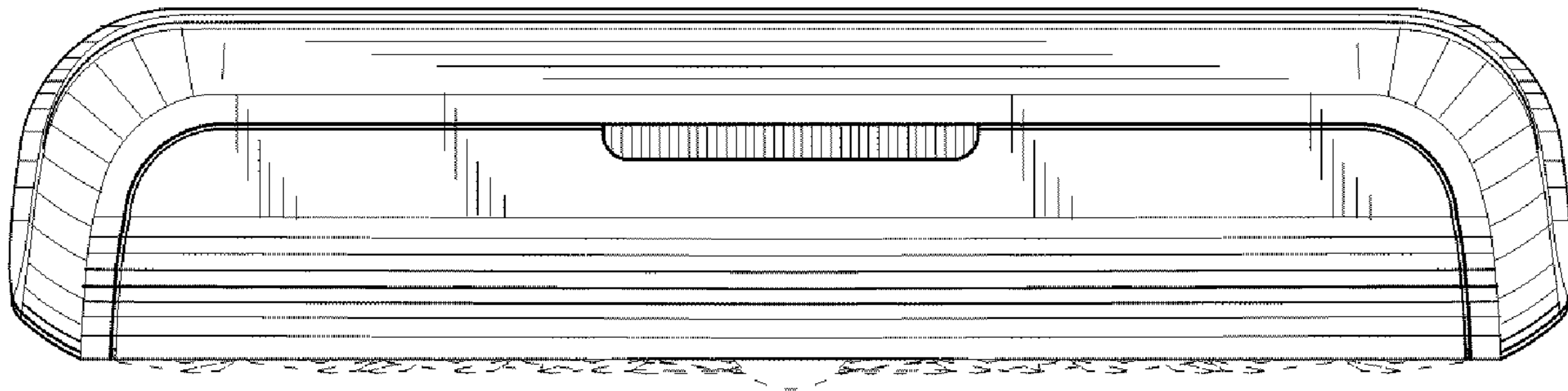

FIG. 7

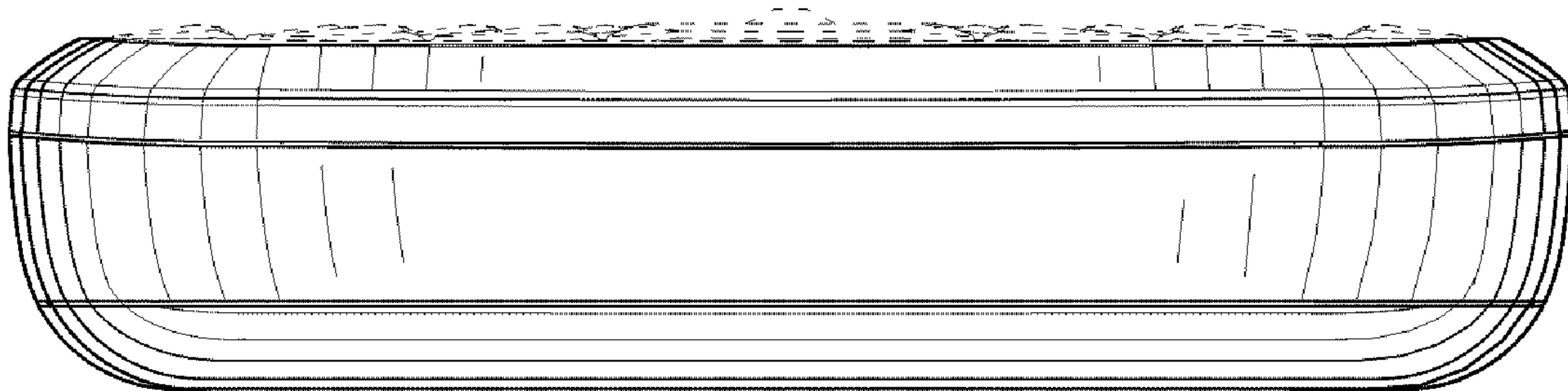

FIG. 8