



US00D612357S

(12) **United States Design Patent**  
**Wang et al.**

(10) **Patent No.:** **US D612,357 S**  
(45) **Date of Patent:** **\*\* Mar. 23, 2010**

(54) **MOBILE PHONE**

(75) Inventors: **Ying-Zhuo Wang**, Shenzhen (CN);  
**Hsiao-Hua Tu**, Taipei Hsien (TW)

(73) Assignee: **FIH (Hong Kong) Limited**, Kowloon  
(HK)

(\*\*) Term: **14 Years**

(21) Appl. No.: **29/336,058**

(22) Filed: **Apr. 28, 2009**

(30) **Foreign Application Priority Data**

Mar. 30, 2009 (CN) ..... 2009 3 0302058

(51) **LOC (9) Cl.** ..... **14-03**

(52) **U.S. Cl.** ..... **D14/138 AD**

(58) **Field of Classification Search** ..... D14/138 R,  
D14/138 AD, 138 AC, 138 C, 138 G, 191,  
D14/203.1-203.8, 496, 138 AA, 138 AB,  
D14/247-248, 137, 147, 218, 341-347; D10/65,  
D10/78, 104; D13/168; D18/7; 455/566,  
455/575.1, 575.3

See application file for complete search history.

(56) **References Cited**

**U.S. PATENT DOCUMENTS**

D496,659 S \* 9/2004 Chien ..... D14/346  
D498,735 S \* 11/2004 Chen et al. .... D14/138 AA  
D498,754 S \* 11/2004 Blyth ..... D14/341  
6,912,463 B2 \* 6/2005 Miwa ..... 701/213  
D511,342 S \* 11/2005 Chien ..... D14/346  
D526,986 S \* 8/2006 Kim ..... D14/138 AD  
D527,000 S \* 8/2006 Hong et al. .... D14/346

(Continued)

**FOREIGN PATENT DOCUMENTS**

TW D124015 8/2008

**OTHER PUBLICATIONS**

Eten M550, announced Apr. 2006, [online], [retrieved on Feb. 20, 2007]. Retrieved from Internet ,<URL: <http://www.gsmarena.com>>.\*

(Continued)

*Primary Examiner*—Jeffrey D Asch

*Assistant Examiner*—Bridget L Eland

(74) *Attorney, Agent, or Firm*—Steven M. Reiss

(57) **CLAIM**

The ornamental design for a mobile phone, as shown and described.

**DESCRIPTION**

FIG. 1 is a perspective view of a mobile phone showing our new design;

FIG. 2 is a front elevational view thereof;

FIG. 3 is a rear elevational view thereof;

FIG. 4 is a left side elevational view thereof;

FIG. 5 is a right side elevational view thereof;

FIG. 6 is a top plan view thereof;

FIG. 7 is a bottom plan view thereof; and,

FIG. 8 is an open view of the mobile phone of FIG. 1 .

The broken lines immediately adjacent the shaded areas represent the bounds of the claimed design while all other broken lines are directed to environment and are for illustrative purposes only; the broken lines form no part of the claimed design.

**1 Claim, 8 Drawing Sheets**

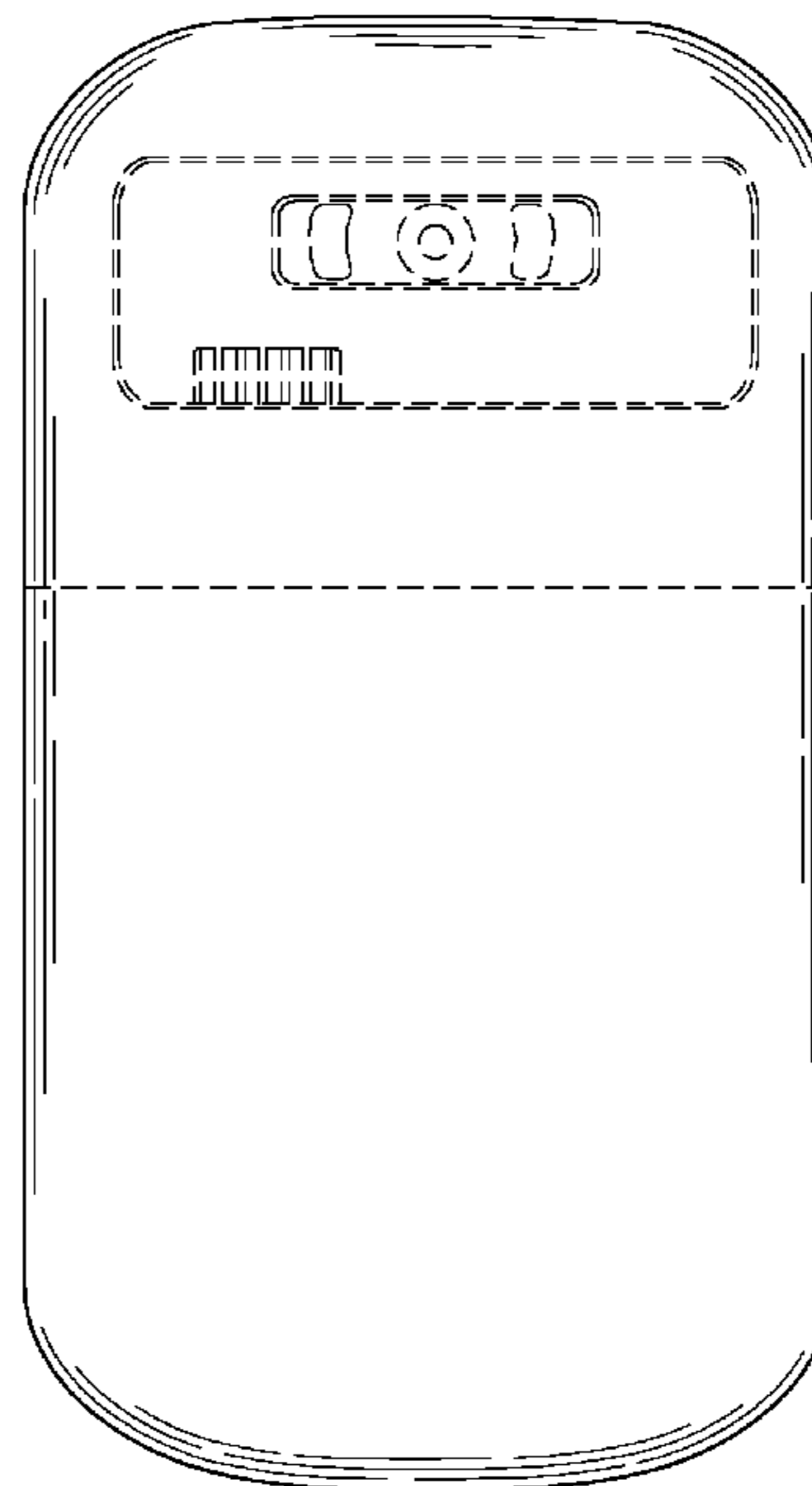
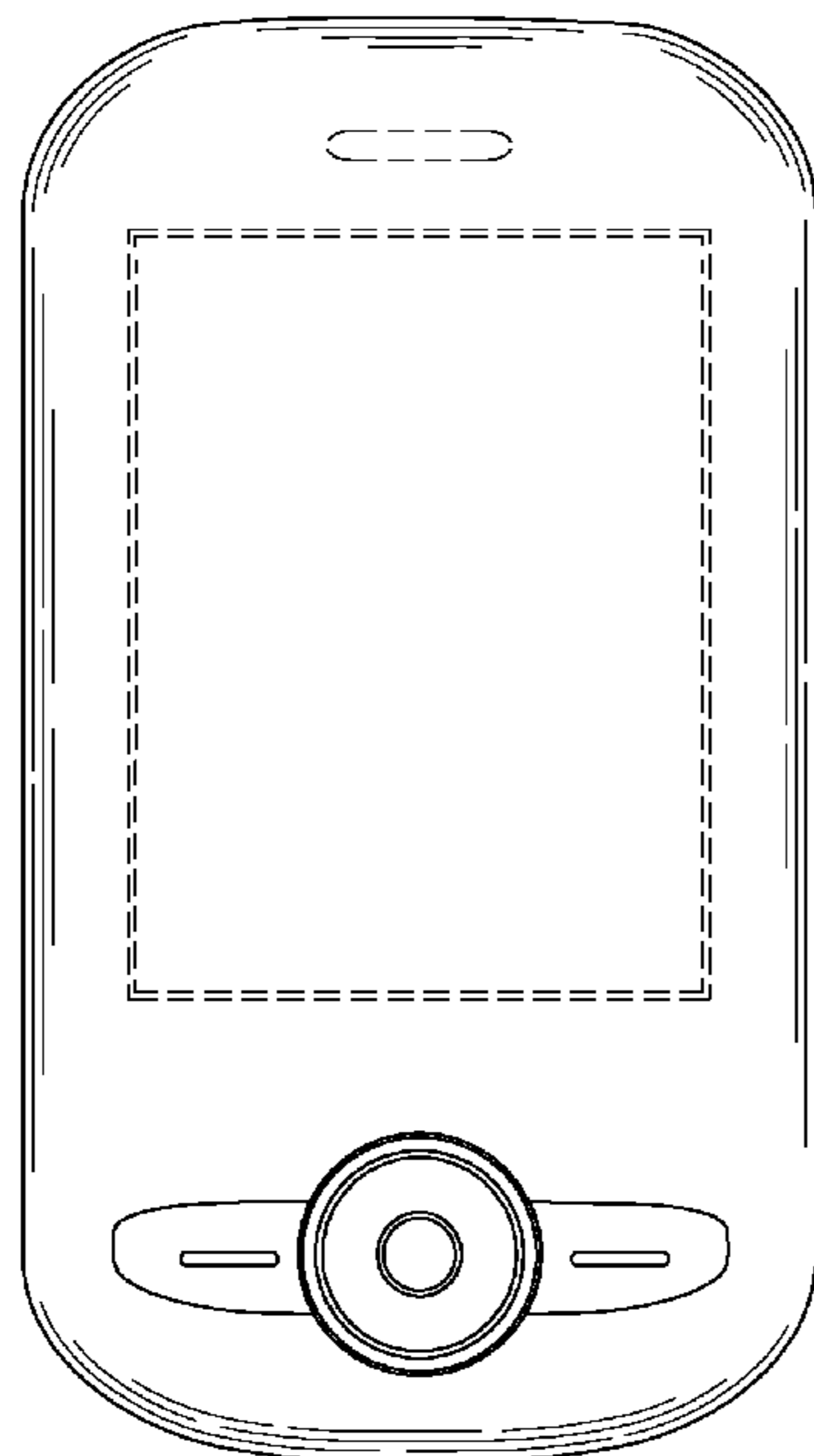

# US D612,357 S

Page 2

## U.S. PATENT DOCUMENTS

D543,176 S \* 5/2007 Hyun et al. .... D14/138 G  
D543,966 S \* 6/2007 Peng et al. .... D14/138 AD  
D545,289 S \* 6/2007 Wang ..... D14/138 AD  
D545,290 S \* 6/2007 Yau ..... D14/138 AD  
D548,713 S \* 8/2007 Lee et al. .... D14/138 AD  
D558,725 S \* 1/2008 Wang ..... D14/138 AD  
D565,533 S \* 4/2008 Kim et al. .... D14/138 AD  
D572,685 S \* 7/2008 Peng ..... D14/138 G  
D572,695 S \* 7/2008 Tu ..... D14/138 AD  
D579,905 S \* 11/2008 Kim et al. .... D14/138 AD  
D580,430 S \* 11/2008 Wei ..... D14/341  
D583,341 S \* 12/2008 Wang ..... D14/138 AB  
D584,709 S \* 1/2009 Chiang ..... D14/138 AD  
D584,727 S \* 1/2009 Liu ..... D14/346  
D588,594 S \* 3/2009 Matsuoka ..... D14/341  
D601,538 S \* 10/2009 Hong ..... D14/138 G

2006/0199612 A1\* 9/2006 Beyer et al. .... 455/556.2  
2006/0223596 A1\* 10/2006 Hur ..... 455/575.4  
2008/0242362 A1\* 10/2008 Duarte ..... 455/566

## OTHER PUBLICATIONS

LG KF310, announced Feb. 2008, [online], [retrieved on Mar. 21, 2008]. Retrieved from Internet ,<URL: <http://www.gsmarena.com>>.\*

Motorola VE75, announced Jul. 2008, [online], [retrieved on Aug. 15, 2008]. Retrieved from Internet ,<URL: <http://www.gsmarena.com>>.\*

Palm Pre, announced Feb. 2009, [online], [retrieved on Mar. 6, 2009]. Retrieved from Internet ,<URL: <http://www.gsmarena.com>>.\*

Qtek 2020, announced 2nd quarter 2004, [online], [retrieved on Feb. 20, 2007]. Retrieved from Internet ,<URL: <http://www.gsmarena.com>>.\*

\* cited by examiner

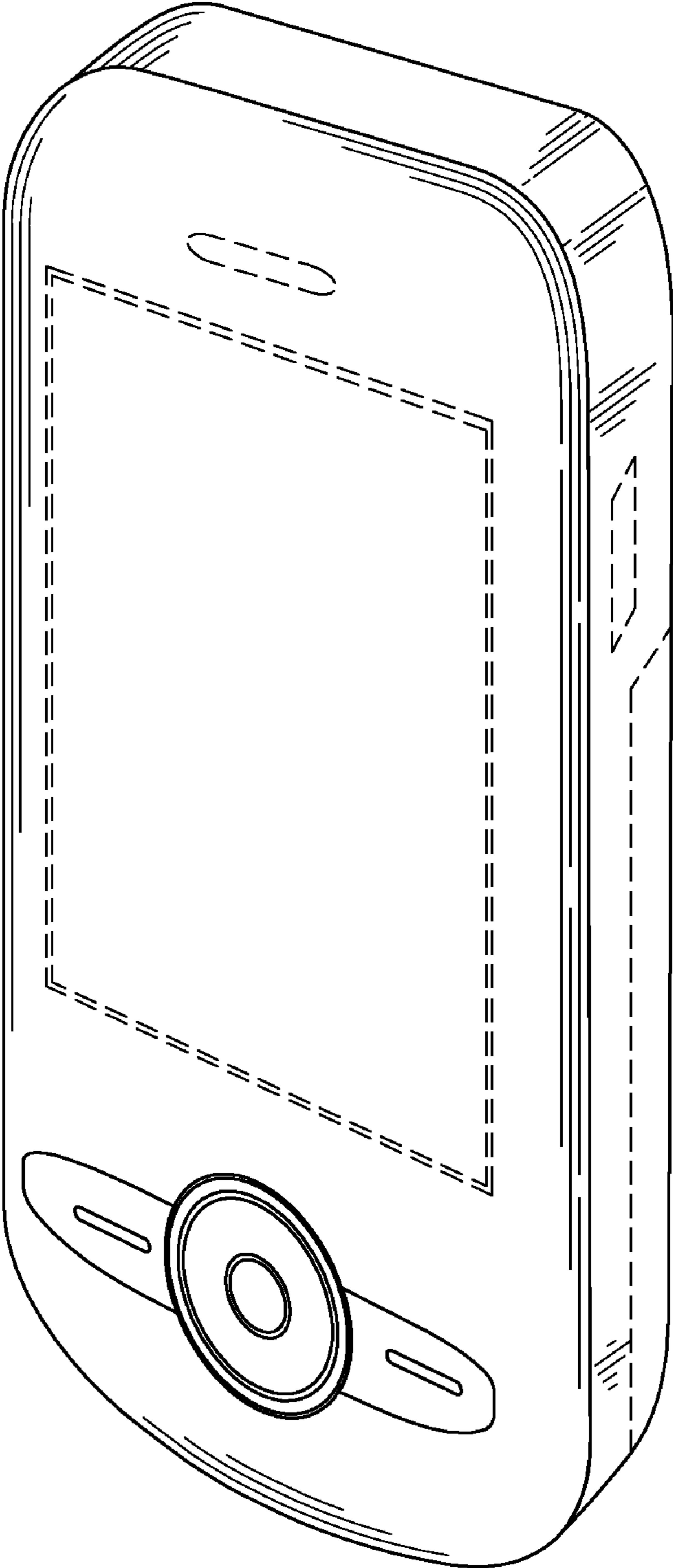

FIG. 1

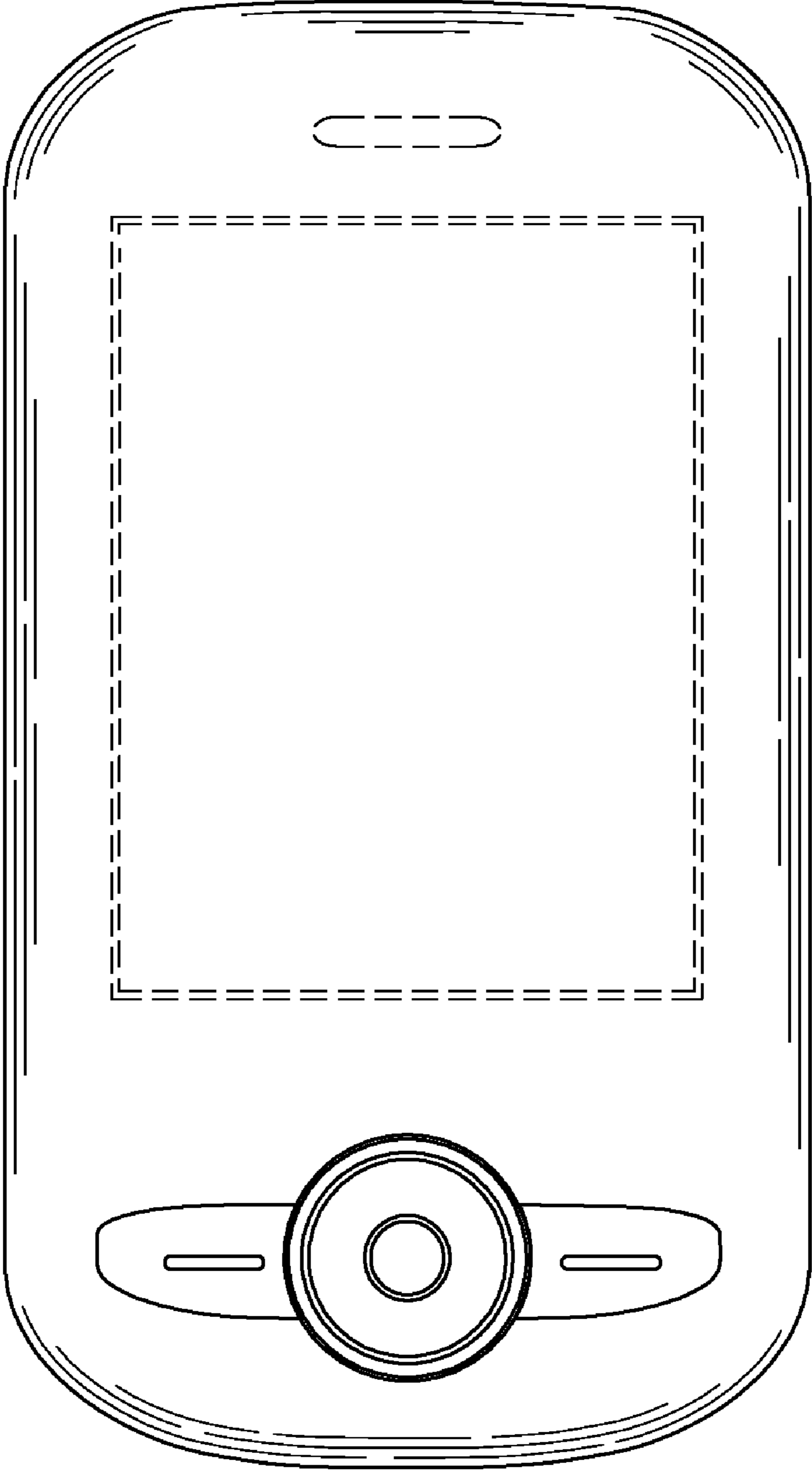

FIG. 2

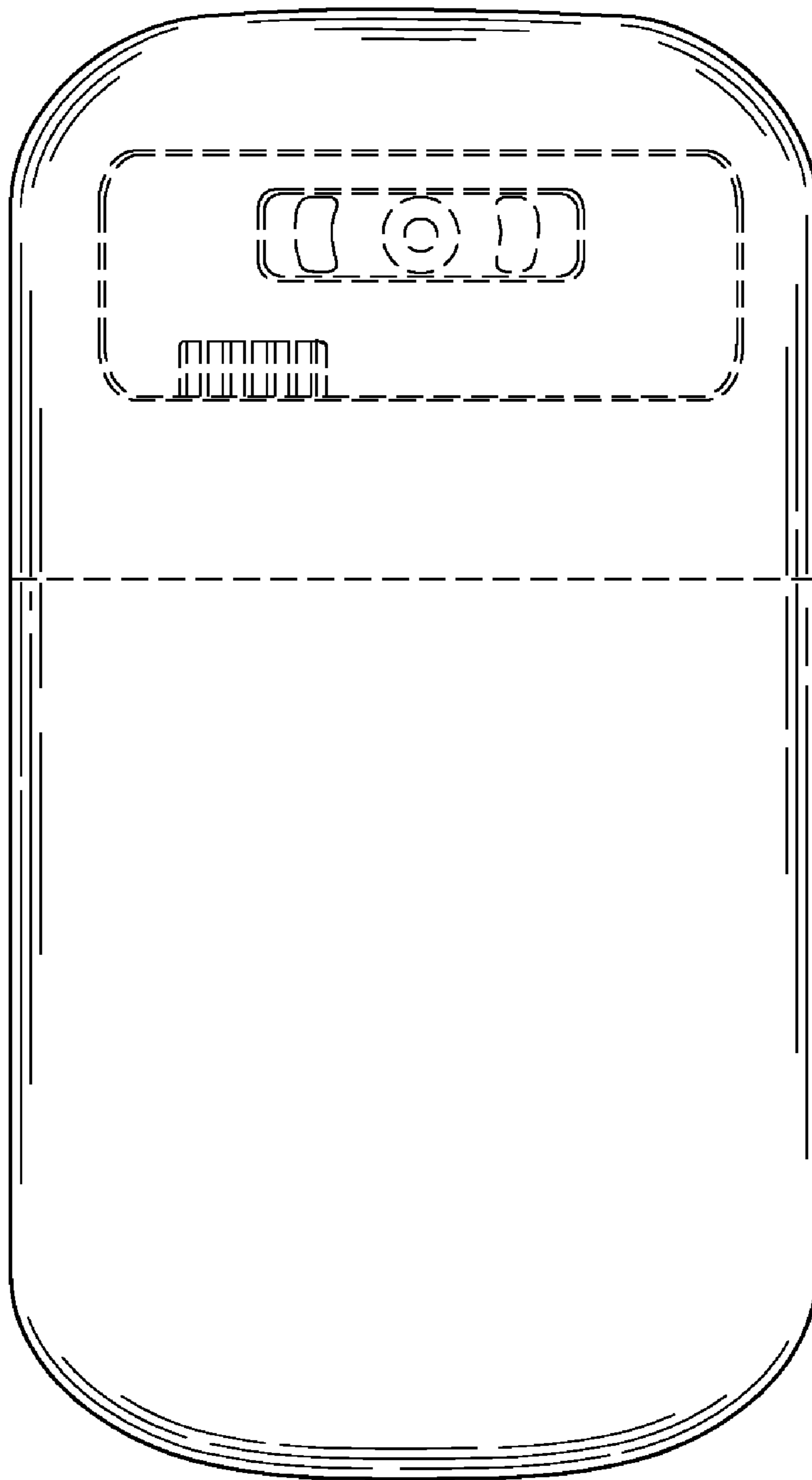

FIG. 3

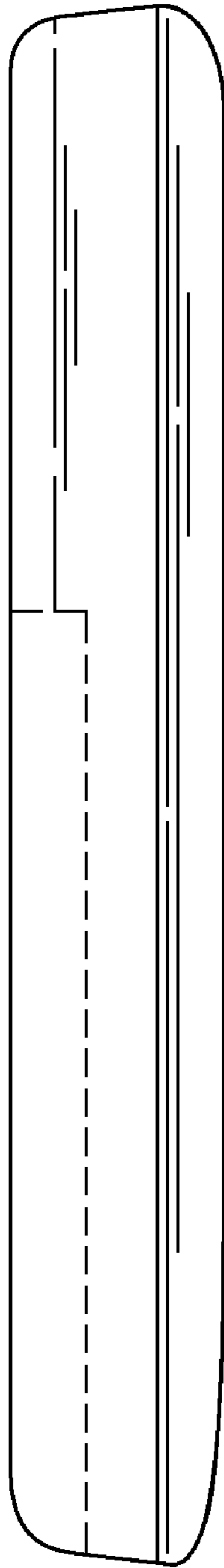

FIG. 4

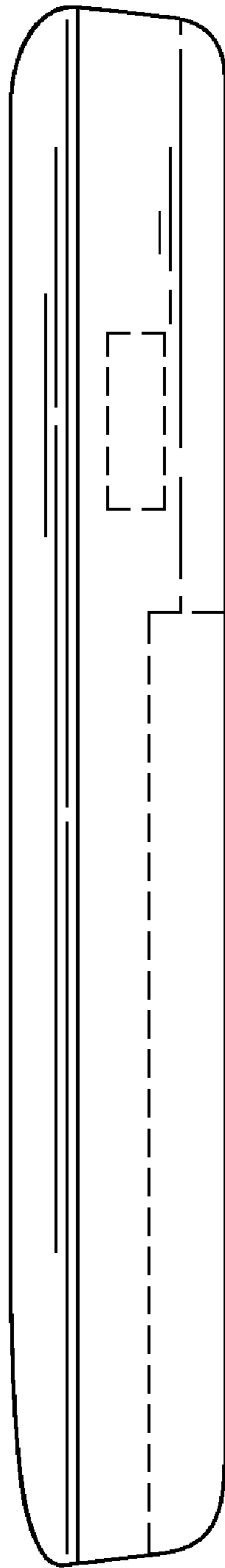

FIG. 5

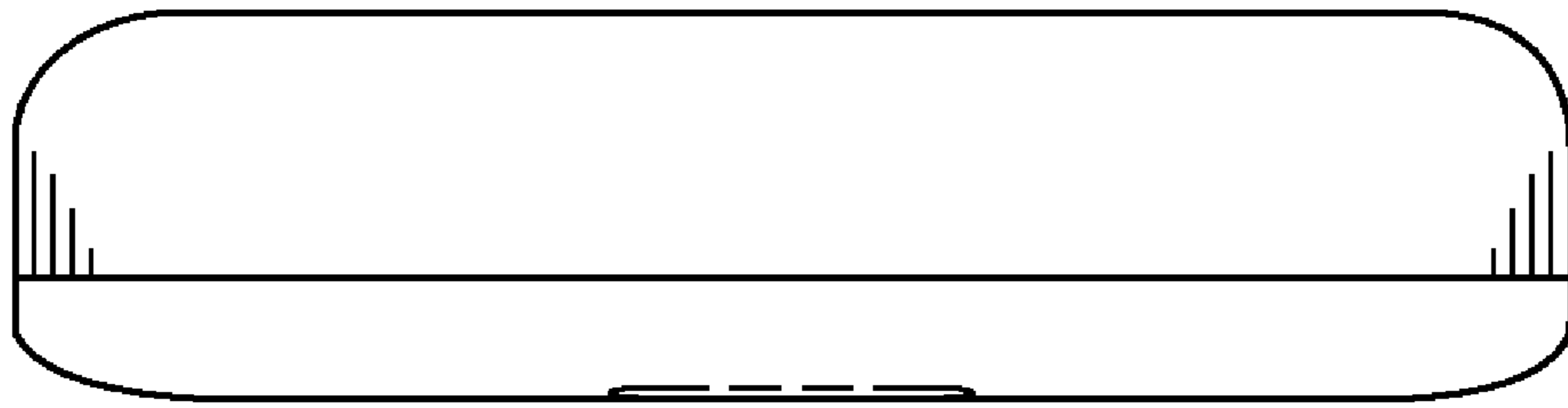

FIG. 6



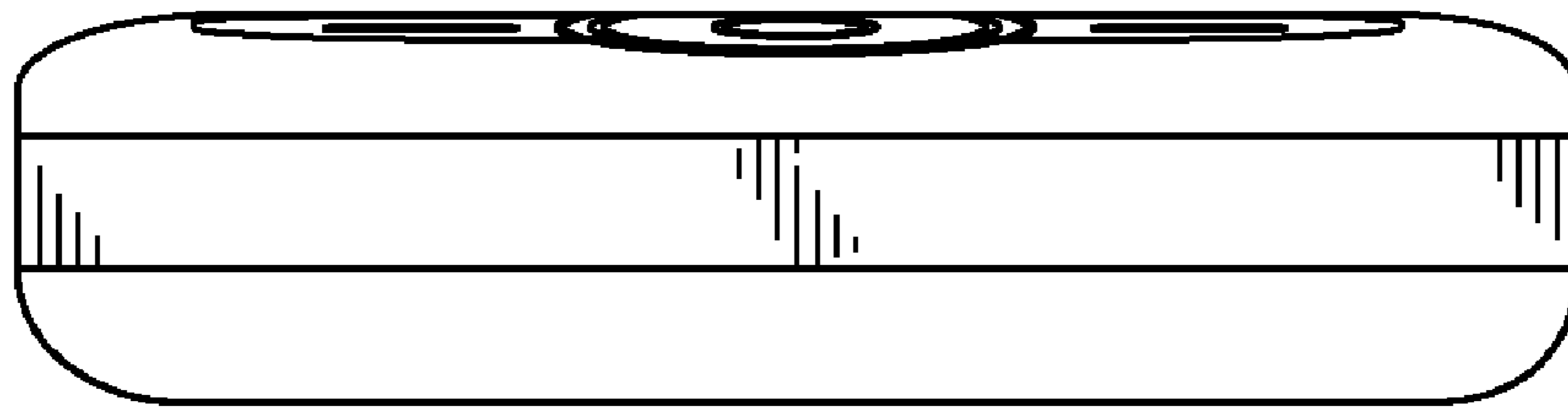

FIG. 7

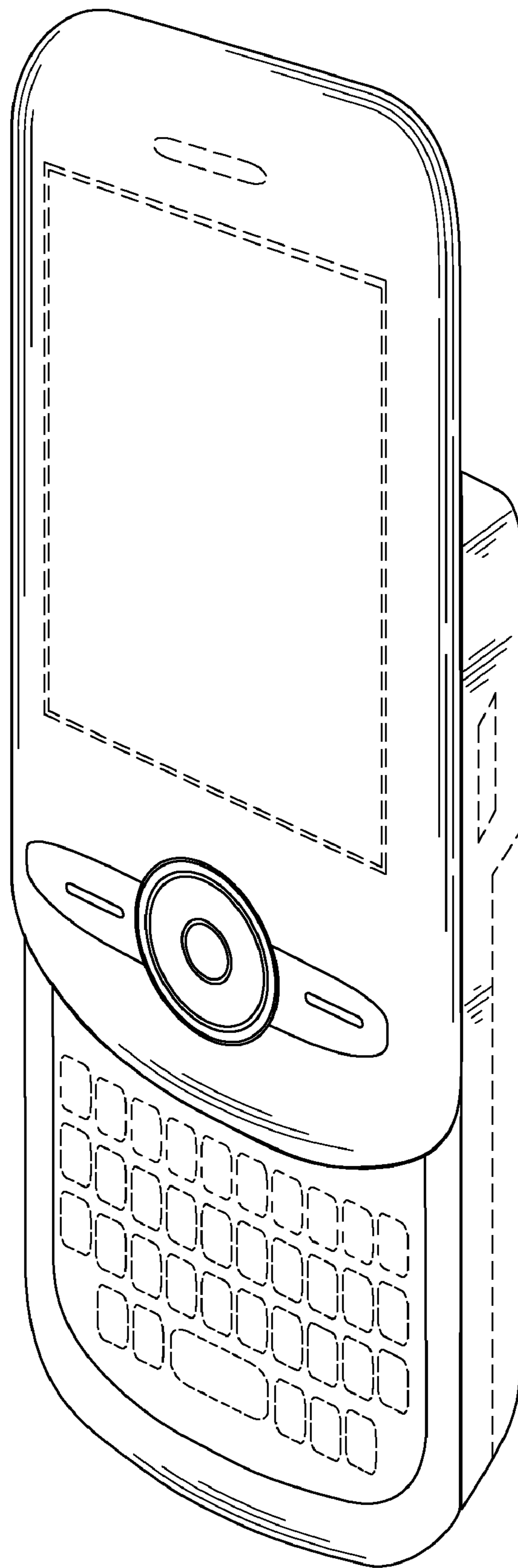

FIG. 8