



US00D612354S

(12) **United States Design Patent**
Salazar et al.

(10) **Patent No.:** **US D612,354 S**
(45) **Date of Patent:** **** Mar. 23, 2010**

(54) **HANDSET**

(75) Inventors: **Eduardo Salazar**, Reseda, CA (US);
Frank Nuovo, Los Angeles, CA (US)

(73) Assignee: **Nokia Corporation**, Espoo (FI)

(**) Term: **14 Years**

(21) Appl. No.: **29/334,156**

(22) Filed: **Mar. 20, 2009**

(51) **LOC (9) Cl.** **14-03**

(52) **U.S. Cl.** **D14/138 AB**

(58) **Field of Classification Search** D14/138 AB,
D14/138 R, 138 AD, 345, 346, 147, 203.4,
D14/203.7, 203.2, 144; 455/575.3; 379/433.1,
379/433.11, 433.13; D21/517
See application file for complete search history.

(56) **References Cited**

U.S. PATENT DOCUMENTS

D508,475 S *	8/2005	Wu et al.	D14/138 AB
D508,684 S *	8/2005	Lee et al.	D14/138 AB
D549,199 S *	8/2007	Sugiura	D14/138 AB
D554,093 S *	10/2007	Arnholt et al.	D14/138 AB
D560,634 S *	1/2008	Lee et al.	D14/138 AB
D563,923 S *	3/2008	Leng et al.	D14/137
D568,849 S	5/2008	Nuovo	
D568,850 S *	5/2008	Lyles	D14/138 AB
D569,822 S	5/2008	Laine	
D572,223 S *	7/2008	Lim	D14/138 AB
D573,122 S *	7/2008	Lee et al.	D14/138 AB
D573,963 S *	7/2008	Kim et al.	D14/138 AB
D573,966 S *	7/2008	Park et al.	D14/138 AB
D576,995 S *	9/2008	Jinde et al.	D14/138 AB
D578,092 S *	10/2008	Lee	D14/138 AB
D578,504 S *	10/2008	Stillerman	D14/138 AB
D579,894 S *	11/2008	Yabe et al.	D14/138 AB
D581,891 S *	12/2008	Baik et al.	D14/138 AB
D582,873 S *	12/2008	Miyata	D14/138 AB
D583,786 S *	12/2008	Jeong et al.	D14/138 AB
D585,863 S *	2/2009	Nilsen et al.	D14/138 AB

2004/0142718 A1 *	7/2004	Kim	455/550.1
2005/0003852 A1 *	1/2005	Song	455/550.1

OTHER PUBLICATIONS

Vertu Constellation Ayxta telephone, announced Sep. 2009, [online], [site visited Nov. 6, 2009]. Available from Internet ,<URL: http://www.gsmarena.com>.*

NEC N900iG telephone, announced 4th quarter 2004, [online], [site visited Nov. 6, 2009]. Available from Internet ,<URL: http://www.gsmarena.com>.*

Pantech PG-1800 telephone, announced Jun. 2006, [online], [site visited Nov. 6, 2009]. Available from Internet ,<URL: http://www.gsmarena.com>.*

Sony Ericsson Z555 telephone, announced Jan. 2008, [online], [site visited Nov. 6, 2009]. Available from Internet ,<URL: http://www.gsmarena.com>.*

* cited by examiner

Primary Examiner—Jeffrey D Asch

(74) *Attorney, Agent, or Firm*—Banner & Witcoff, Ltd.

(57) **CLAIM**

The ornamental design for a handset, as shown and described.

DESCRIPTION

FIG. 1 is a perspective front view of a first handset showing our new design;

FIG. 2 is a front view thereof;

FIG. 3 is a right side view thereof;

FIG. 4 is a left side view thereof;

FIG. 5 is a bottom view thereof;

FIG. 6 is a top view thereof; and,

FIG. 7 is a rear view thereof.

The broken lines shown throughout the views that are immediately adjacent to the shaded areas and define unshaded regions, represent the bounds of the claimed design, while any other broken lines are directed to environment and are for illustrative purposes only; the broken lines form no part of the claimed design.

1 Claim, 5 Drawing Sheets

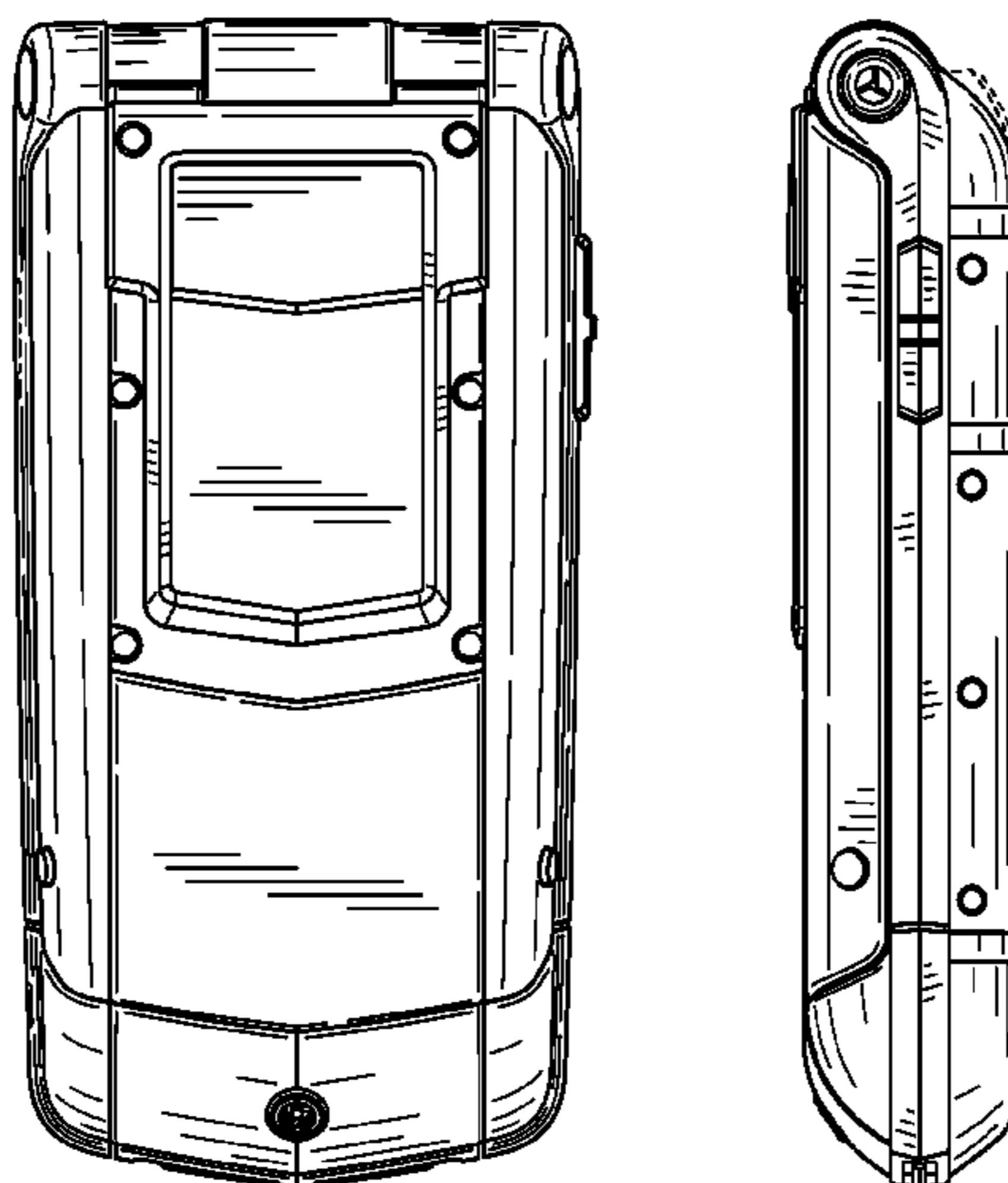

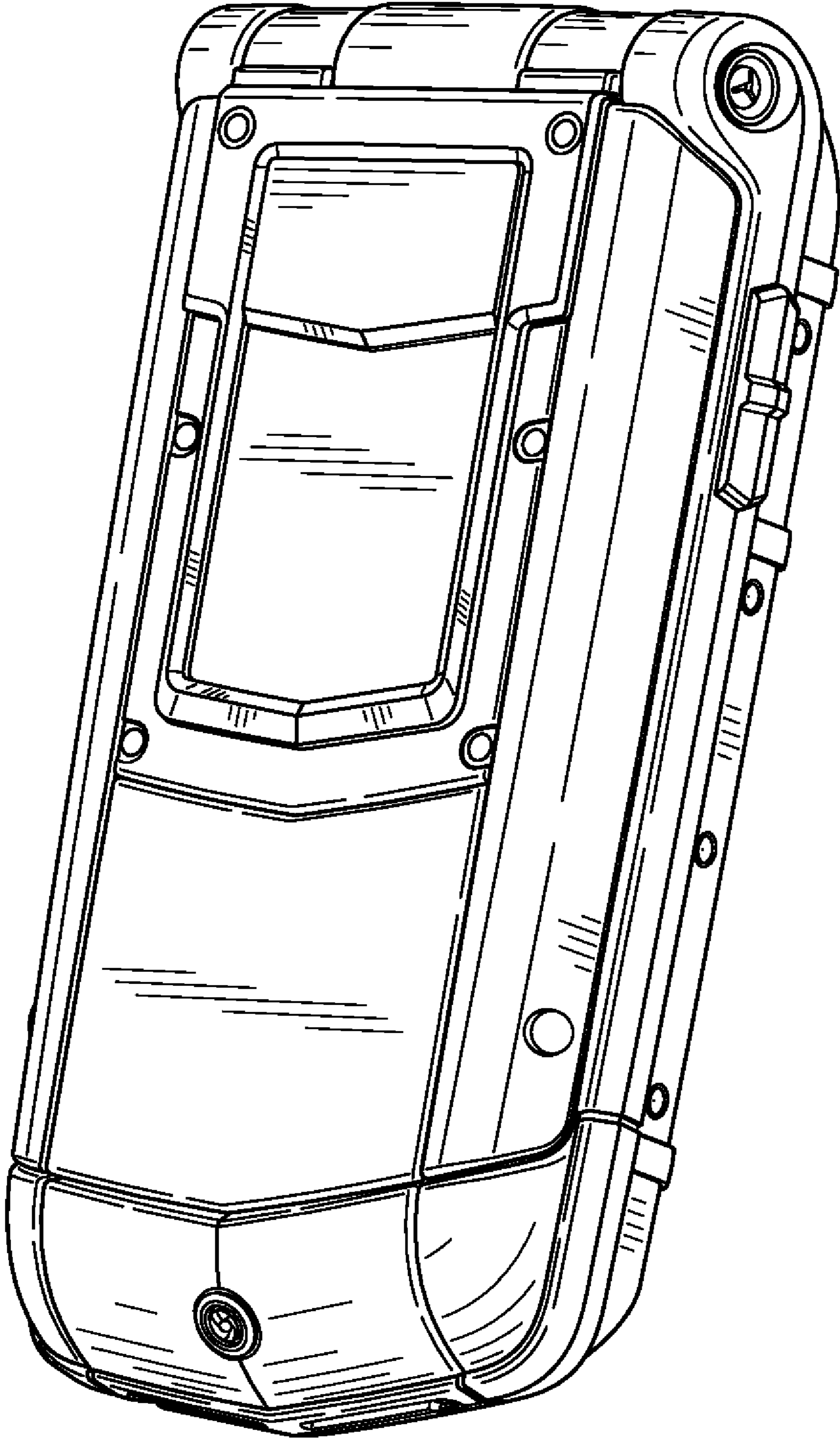

FIG. 1

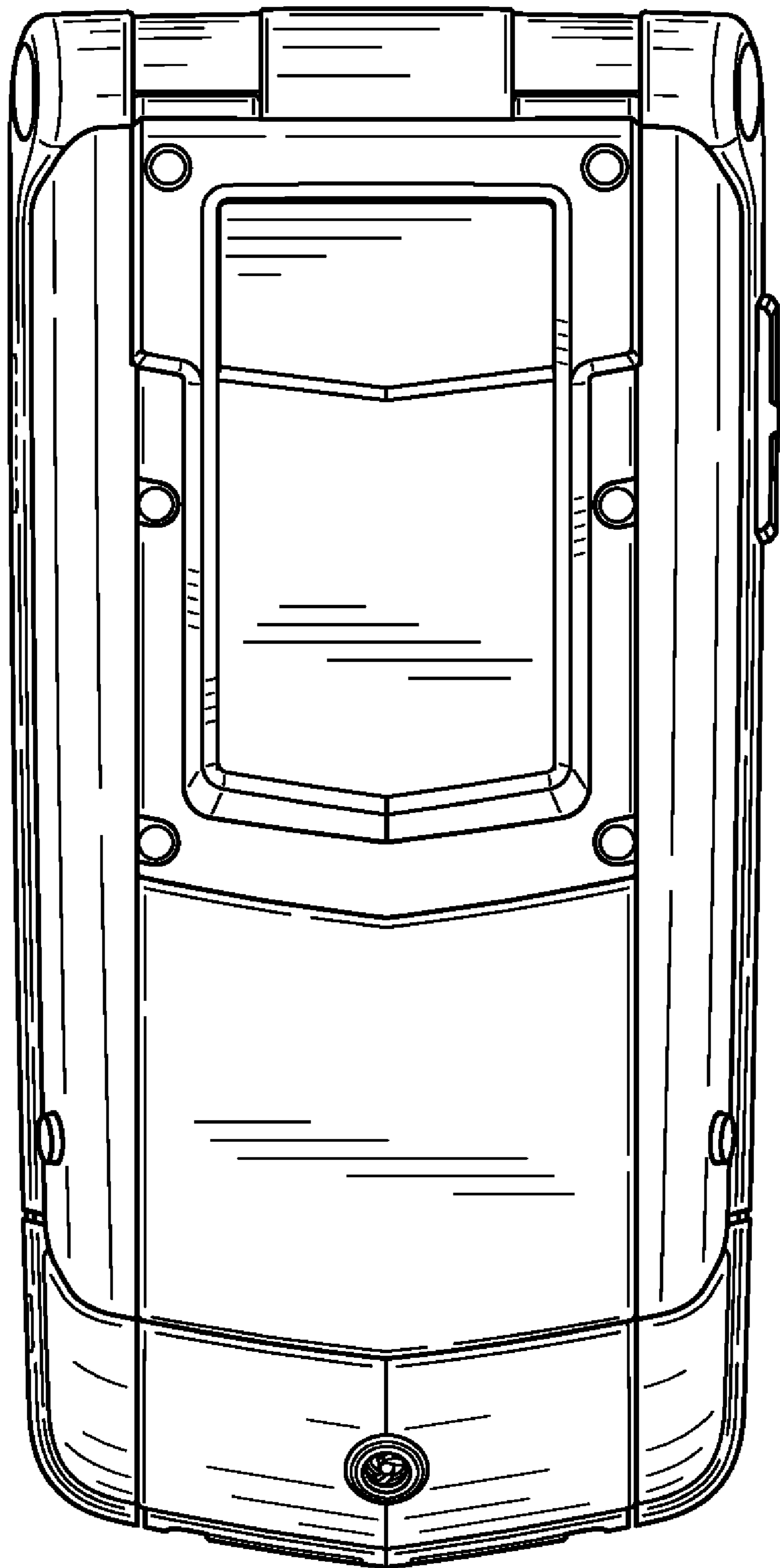

FIG. 2

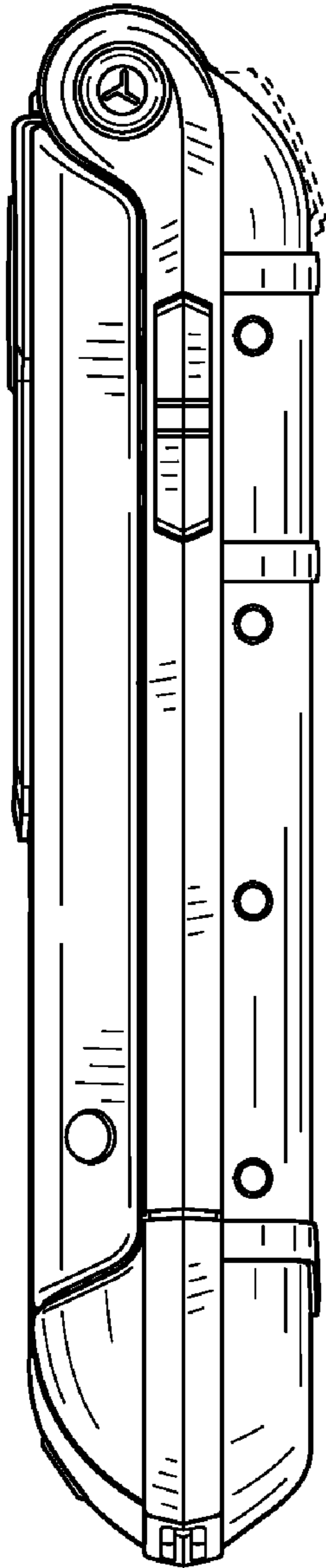

FIG. 3

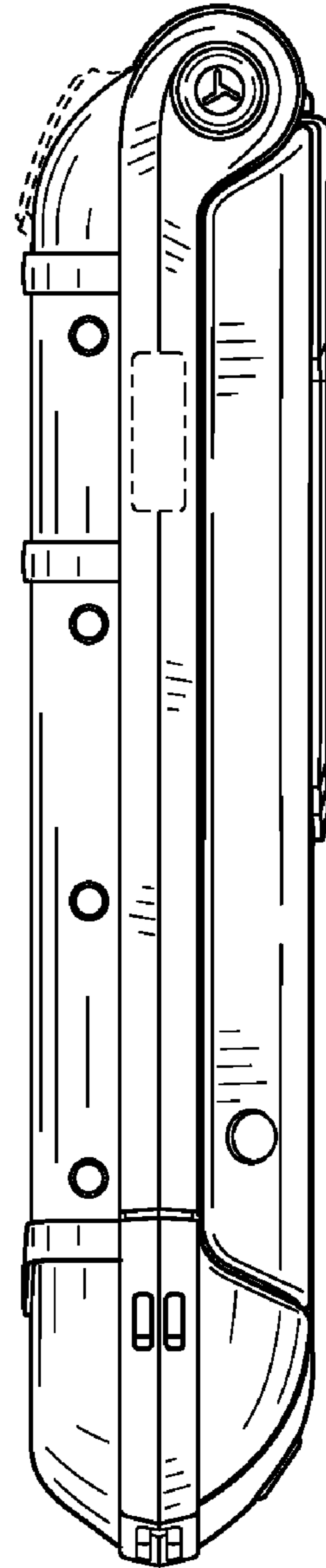

FIG. 4

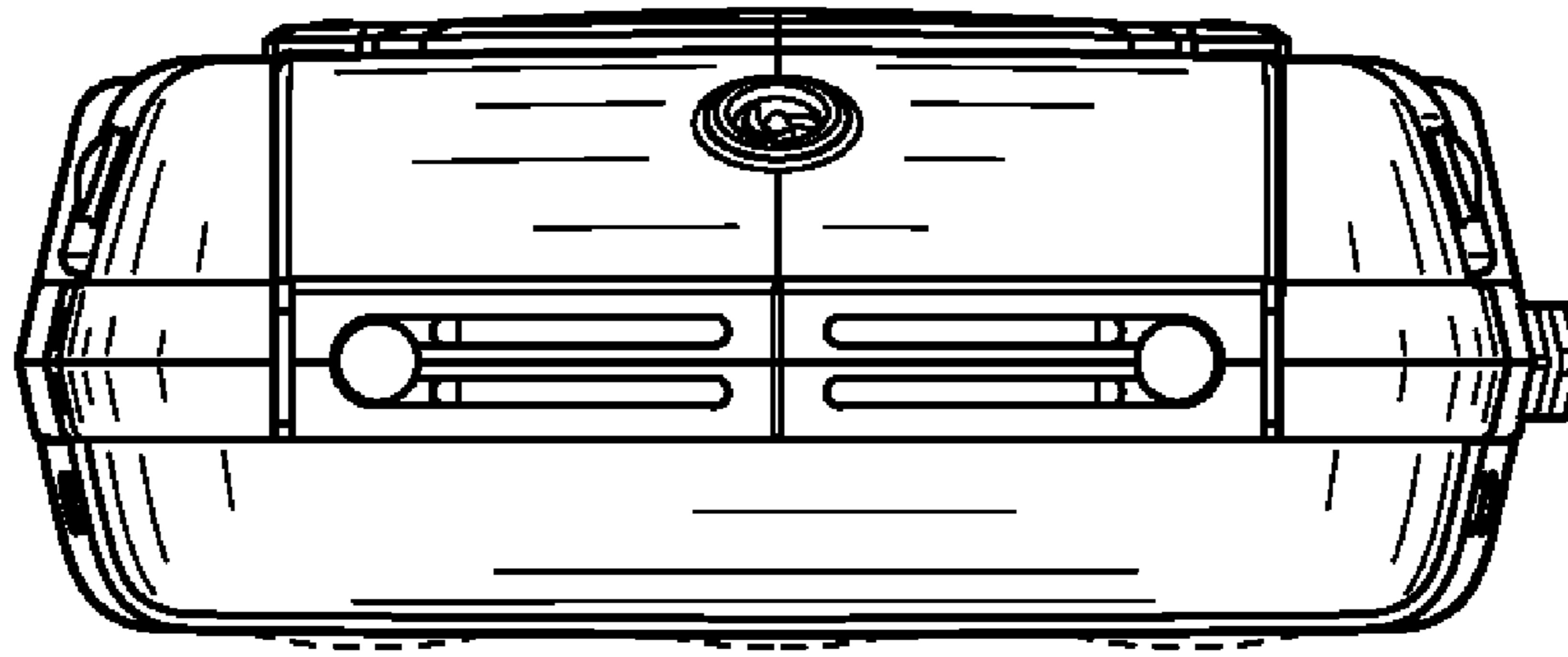

FIG. 5

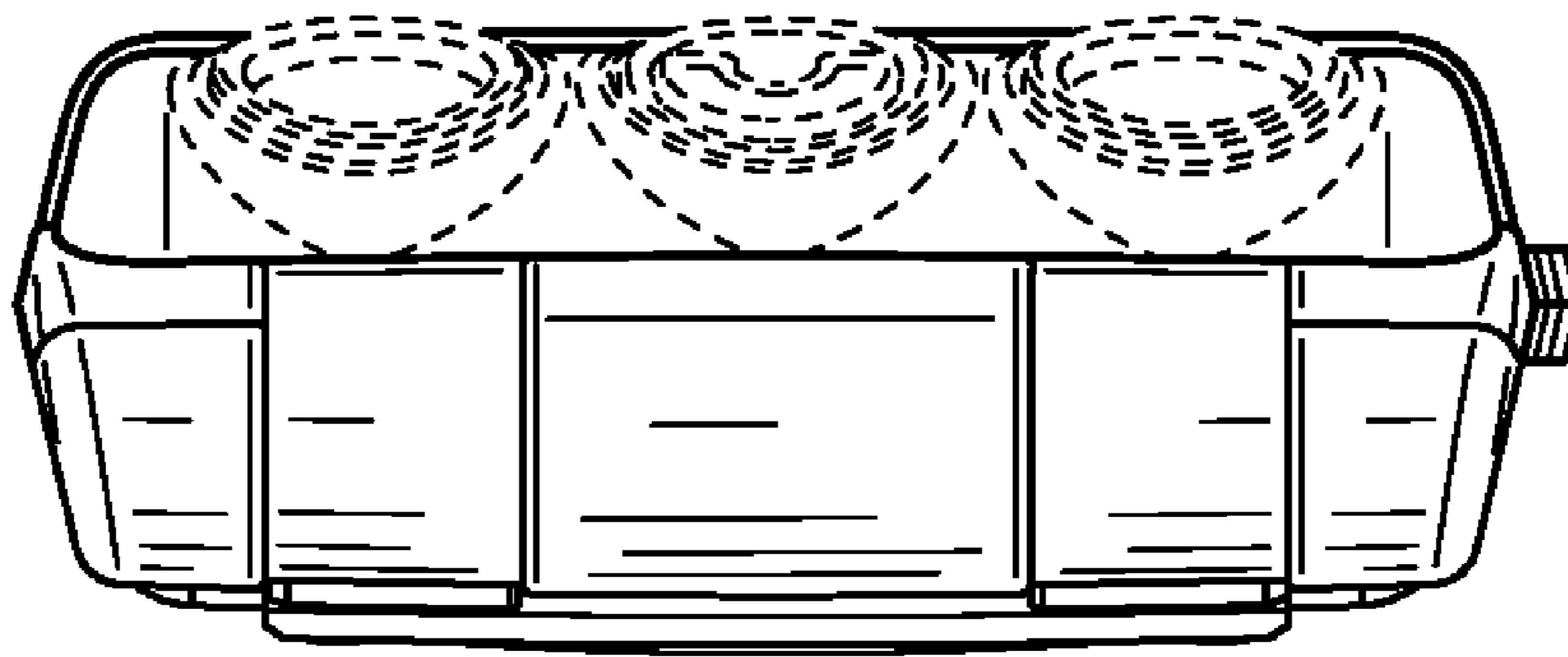

FIG. 6

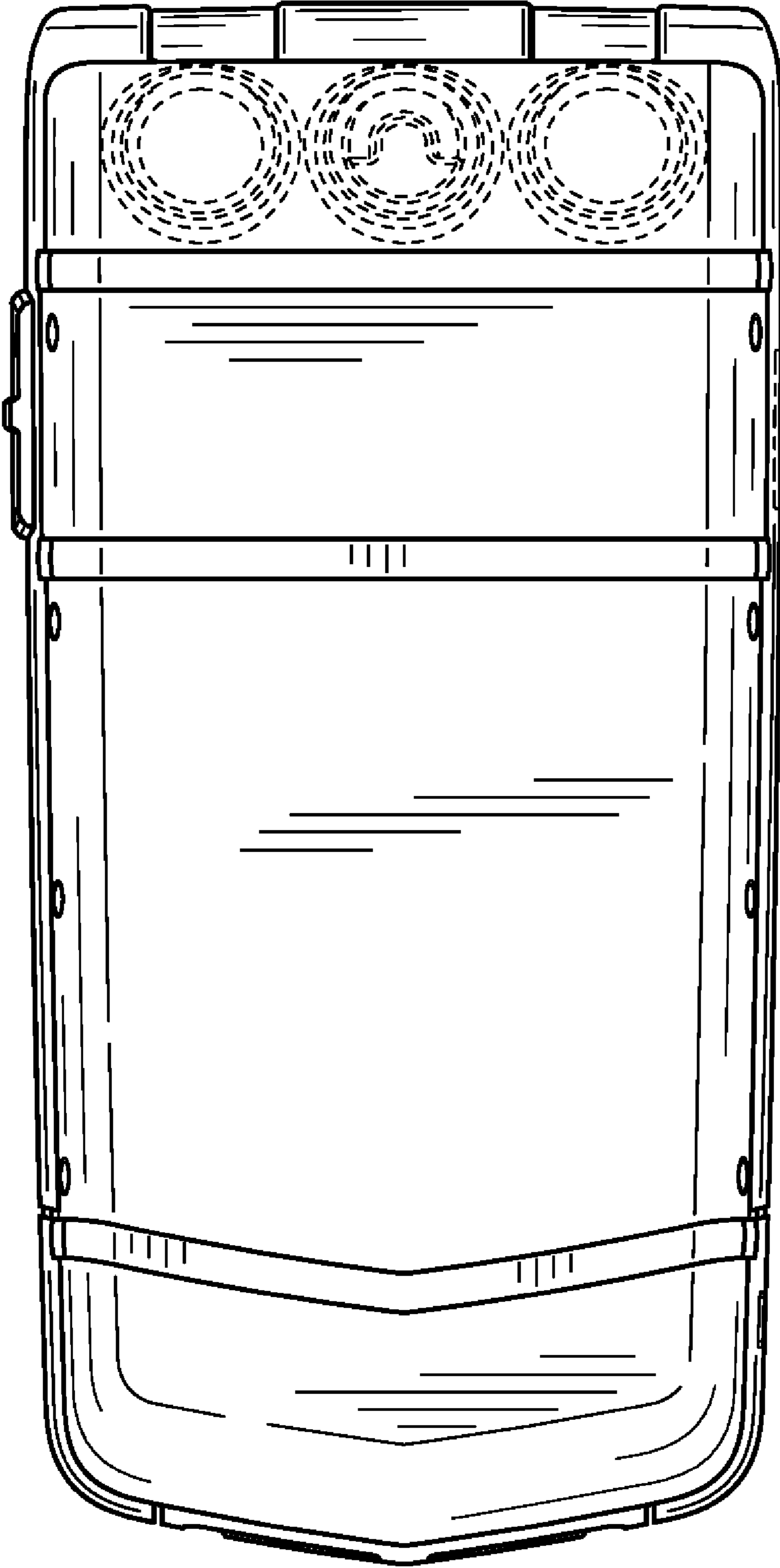

FIG. 7