



US00D612350S

(12) **United States Design Patent**  
**Park et al.**

(10) **Patent No.:** **US D612,350 S**  
(45) **Date of Patent:** **\*\* Mar. 23, 2010**

(54) **MOBILE PHONE**

(75) Inventors: **Dae Yoeb Park**, Seoul (KR); **Nam Mi Kim**, Seoul (KR); **Chang Soo Lee**, Seoul (KR)

(73) Assignee: **Samsung Electronics Co., Ltd.**, Suwon (KR)

(\*\*) Term: **14 Years**

(21) Appl. No.: **29/292,319**

(22) Filed: **Oct. 5, 2007**

(51) **LOC (9) Cl.** ..... **14-03**

(52) **U.S. Cl.** ..... **D14/138 AD**

(58) **Field of Classification Search** ..... D14/138 R,  
D14/138 AD, 138 AC, 138 C, 138 G, 191,  
D14/203.1–203.8, 496, 138 AA, 138 AB,  
D14/247–248, 137, 147, 218, 341–347; D10/65,  
D10/78, 104; D13/168; D18/7; 455/566,  
455/575.1, 575.3

See application file for complete search history.

(56) **References Cited**

**U.S. PATENT DOCUMENTS**

D495,695 S *	9/2004	Yugaya	.....	D14/346
D503,699 S *	4/2005	Lee et al.	.....	D14/138 AD
D509,202 S *	9/2005	Lee et al.	.....	D14/138 AD
D525,609 S *	7/2006	Kim et al.	.....	D14/138 AB
D528,094 S *	9/2006	Hwang	.....	D14/138 AD
D529,474 S *	10/2006	Park et al.	.....	D14/138 AD
D530,297 S *	10/2006	Moon et al.	.....	D14/138 G
D536,691 S *	2/2007	Park	.....	D14/138 AD
D545,843 S *	7/2007	Song	.....	D14/496
D551,201 S *	9/2007	Kim et al.	.....	D14/138 AD
D552,579 S *	10/2007	Lee et al.	.....	D14/138 AC
D557,245 S *	12/2007	Kim et al.	.....	D14/138 AD
D558,713 S *	1/2008	Kim et al.	.....	D14/138 AD
D558,789 S *	1/2008	Yu et al.	.....	D14/496
D561,721 S *	2/2008	Jung et al.	.....	D14/138 AD
D563,929 S *	3/2008	Park	.....	D14/138 AD
D575,759 S *	8/2008	Park et al.	.....	D14/138 AD
D579,899 S *	11/2008	Park et al.	.....	D14/138 AD

D584,708 S *	1/2009	Wu et al.	.....	D14/138 AD
D589,483 S *	3/2009	Tkachuk	.....	D14/138 AD
D593,518 S *	6/2009	Hong et al.	.....	D14/138 AD
D593,519 S *	6/2009	Hong et al.	.....	D14/138 AD
D600,666 S *	9/2009	Chen	.....	D14/138 AD
D601,111 S *	9/2009	Sterzick et al.	.....	D14/138 AD
2005/0090298 A1 *	4/2005	Park et al.	.....	455/575.4
2005/0255897 A1 *	11/2005	Lee et al.	.....	455/575.4

**OTHER PUBLICATIONS**

BenQ EL71 and/or BenQ-Siemens EL71, both announced Feb. 2006, [online], [retrieved on Dec. 13, 2007 and Feb. 16, 2007 respectively]. Retrieved from Internet ,<URL: http://www.gsmarena.com>.\*  
LG KG800, announced 1st quarter Mar. 2006, [online], [retrieved on Feb. 20, 2007]. Retrieved from Internet ,<URL: http://www.gsmarena.com>.\*

(Continued)

*Primary Examiner*—Jeffrey D Asch  
*Assistant Examiner*—Bridget L Eland  
(74) *Attorney, Agent, or Firm*—Ladas and Parry LLP

(57) **CLAIM**

The ornamental design for a mobile phone, as shown and described.

**DESCRIPTION**

FIG. 1 is a front/right-side/top perspective view of a mobile phone showing our new design;  
FIG. 2 is a front elevational view thereof;  
FIG. 3 is a rear elevational view thereof;  
FIG. 4 is a left-side elevational view thereof;  
FIG. 5 is a right-side elevational view thereof;  
FIG. 6 is a top plan view thereof;  
FIG. 7 is a bottom plan view thereof; and,  
FIG. 8 is a front/right-side/top perspective view thereof showing the mobile phone in an alternate position.

**1 Claim, 7 Drawing Sheets**

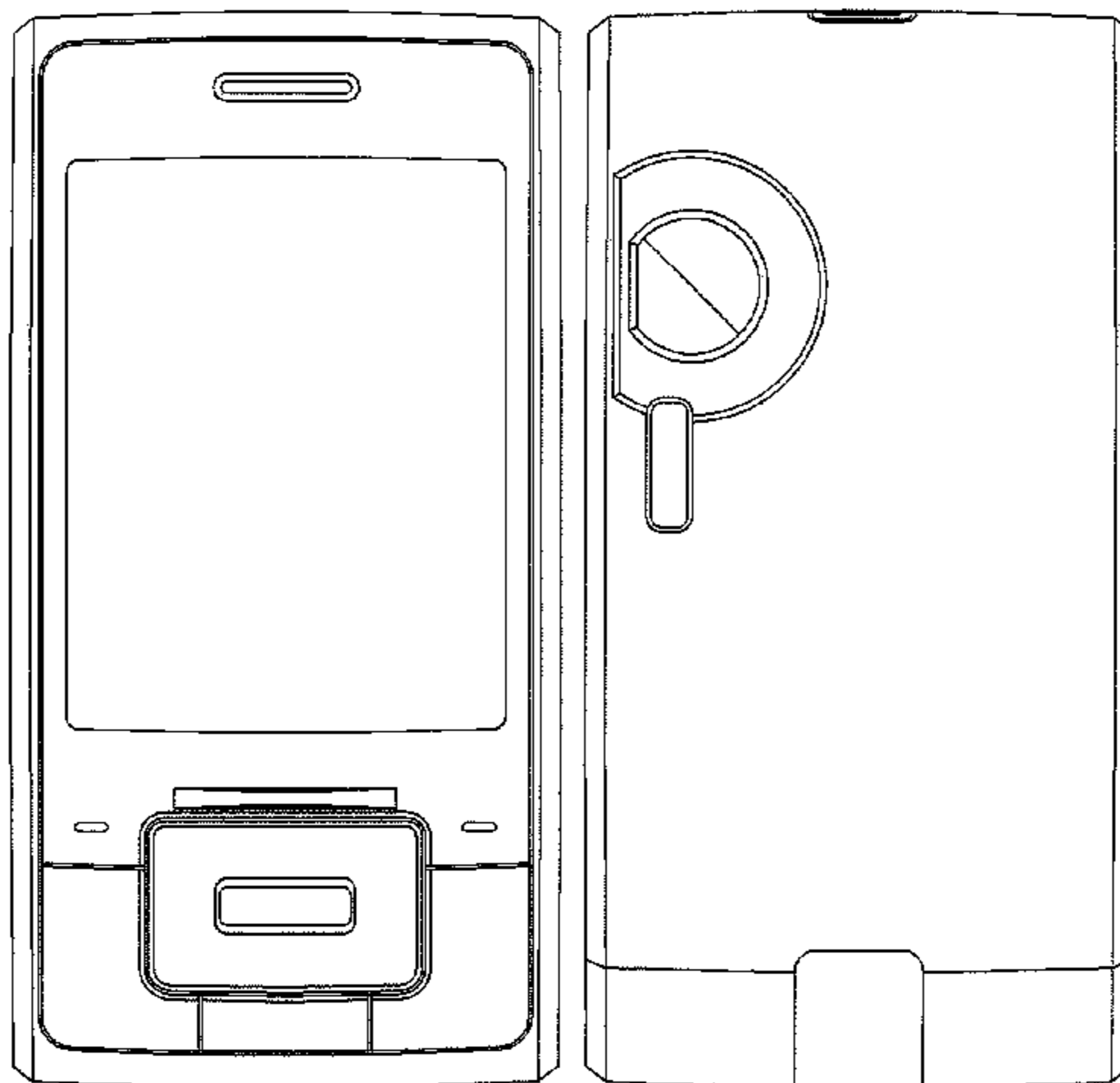

OTHER PUBLICATIONS

LG KS10, announced Feb. 2007, [online], [retrieved on Feb. 20, 2007]. Retrieved from Internet ,<URL: <http://www.gsmarena.com>>.\*

Samsung i750, announced 1st quarter 2005, [online], [retrieved on Feb. 8, 2007]. Retrieved from Internet ,<URL: <http://www.gsmarena.com>>.\*

Samsung G800, announced Oct. 2007, [online], [retrieved on Dec. 13, 2007]. Retrieved from Internet ,<URL: <http://www.gsmarena.com>>.\*

Asus nuvifone M20, announced Feb. 2009, [online], [retrieved on Mar. 6, 2009]. Retrieved from Internet ,<URL: <http://www.gsmarena.com>>.\*

Huawei U7310, announced 2<sup>nd</sup> quarter 2008, [online], [retrieved on Feb. 20, 2009]. Retrieved from Internet ,<URL: <http://www.gsmarena.com>>.\*

\* cited by examiner

FIG. 1

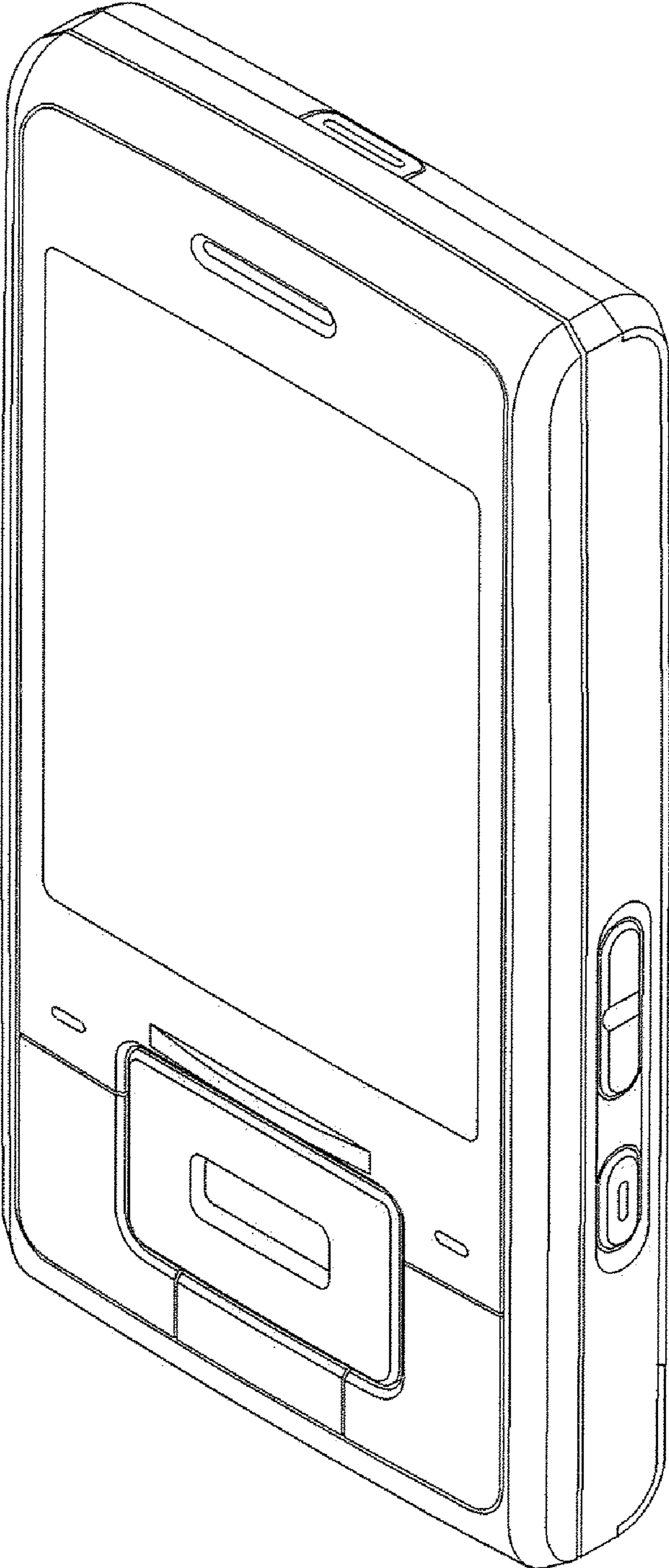

FIG. 2

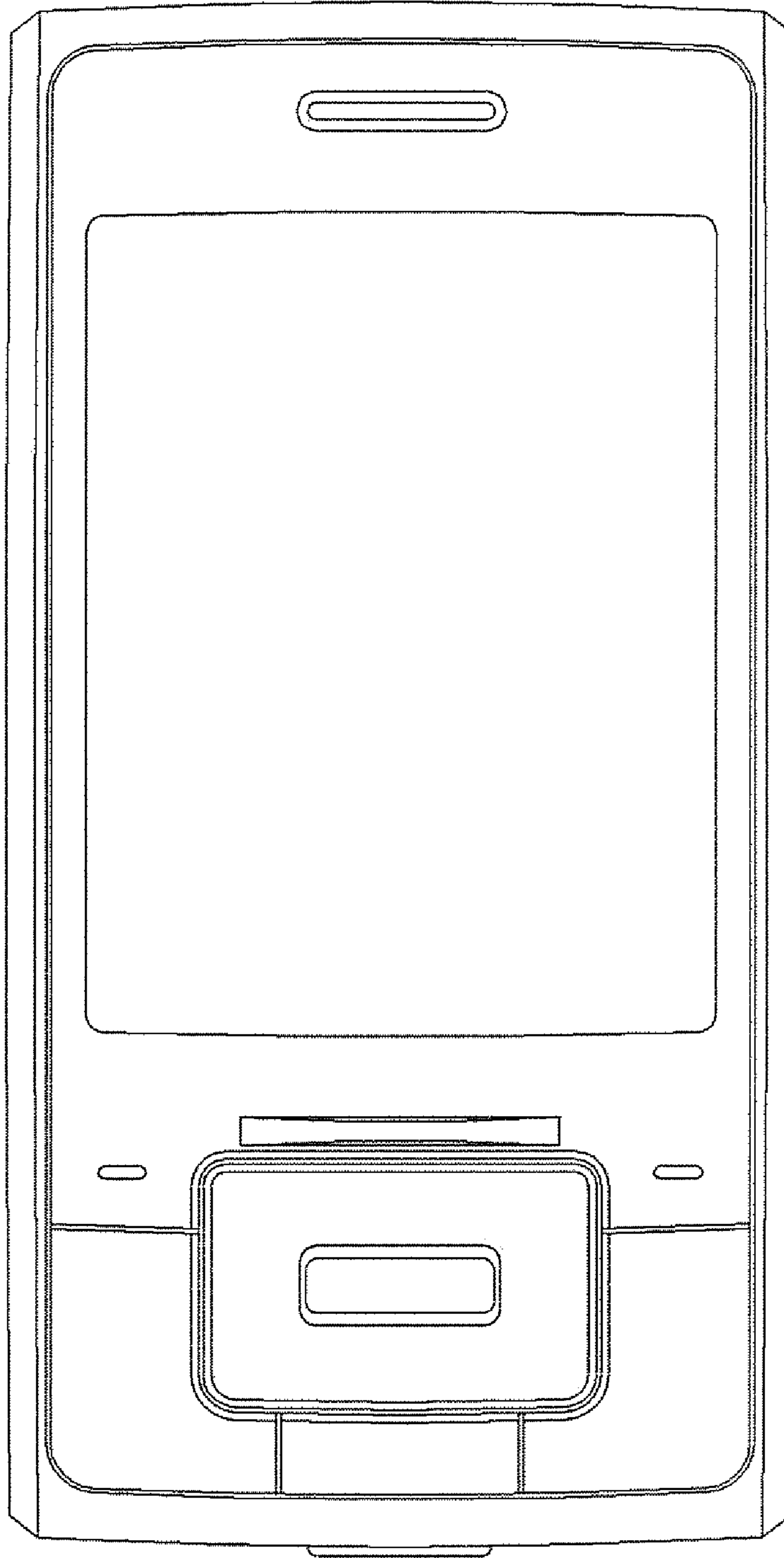

FIG. 3

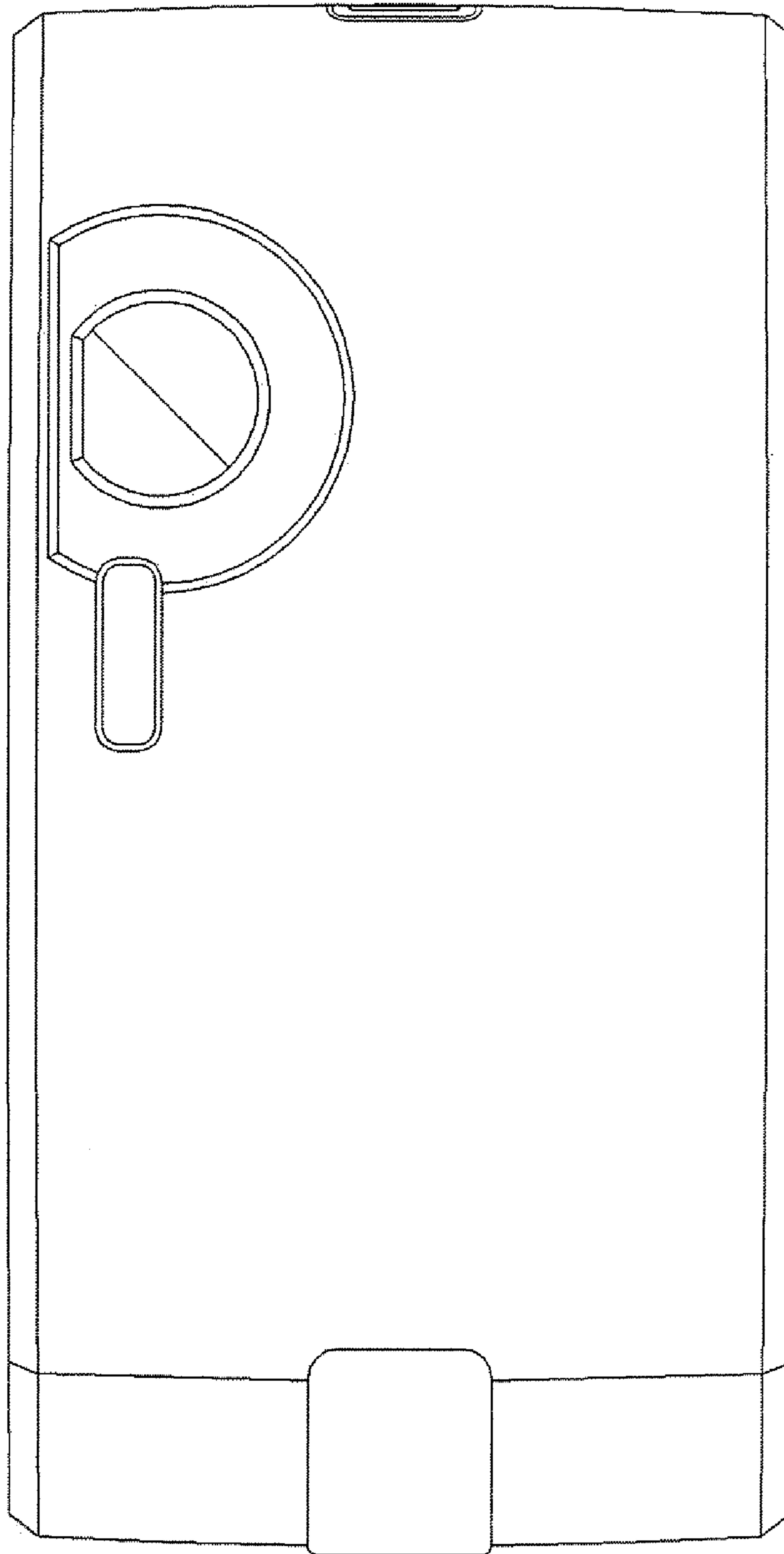

FIG. 4

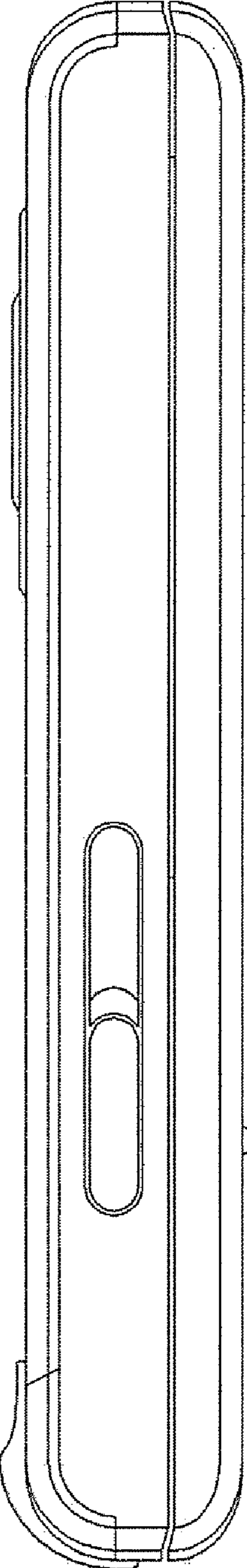
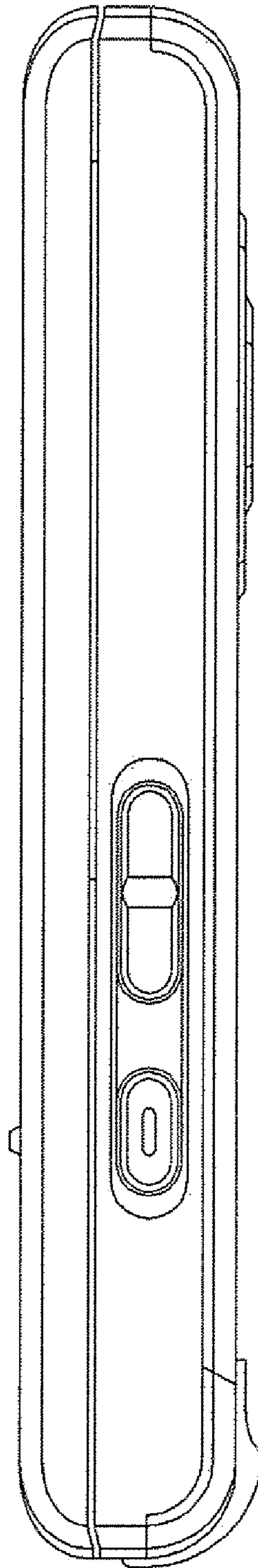
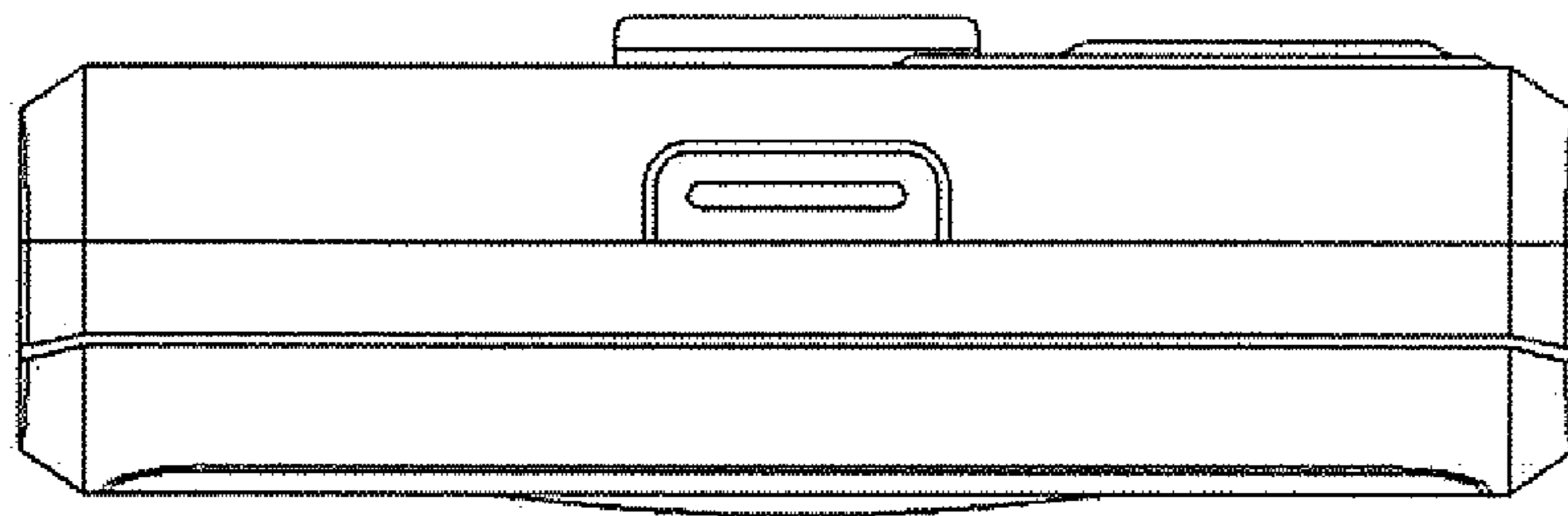

FIG. 5



**FIG. 6**



**FIG. 7**

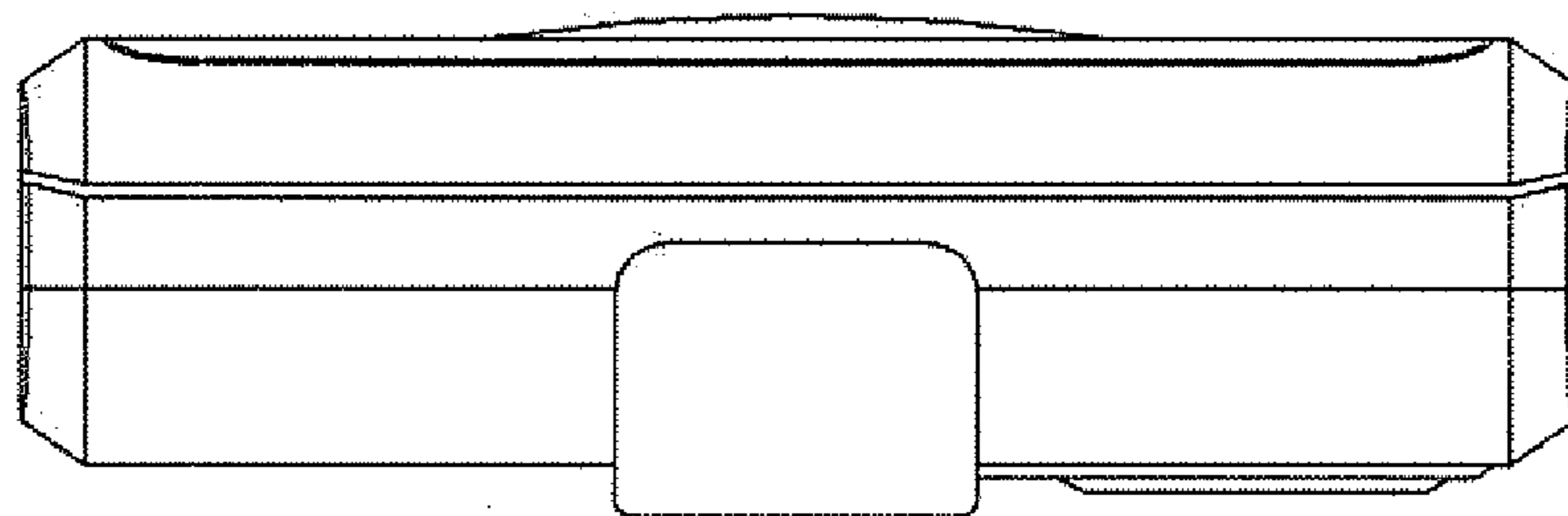



FIG. 8

