



US00D612333S

(12) **United States Design Patent**
Wu

(10) **Patent No.:** **US D612,333 S**
(45) **Date of Patent:** **** Mar. 23, 2010**

(54) **MULTI-PLUG SOCKET**

(75) Inventor: **Jui-Hsiung Wu**, Taipei (TW)

(73) Assignee: **Well Shin Technology Co., Ltd.**, Taipei (TW)

(**) Term: **14 Years**

(21) Appl. No.: **29/344,115**

(22) Filed: **Sep. 23, 2009**

(51) **LOC (9) Cl.** **13-03**

(52) **U.S. Cl.** **D13/139.1**

(58) **Field of Classification Search** D13/138.1,
D13/138.2, 139.1, 139.2, 139.3, 139.4, 139.5,
D13/139.6, 139.7, 139.8, 137.1, 137.2, 137.3,
D13/137.4, 133, 107, 108, 110, 123, 146,
D13/147, 149, 151, 154; D14/240, 256,
D14/217, 433; 174/494, 67, 202, 206, 53,
174/59; 439/35, 222, 249, 919, 909, 171,
439/518, 956, 105, 53, 63, 106, 136, 149,
439/266, 300, 373, 654, 660, 907; 320/111,
320/114; 363/146

See application file for complete search history.

(56) **References Cited**

U.S. PATENT DOCUMENTS

D277,370 S * 1/1985 Gehr et al. D13/137.2
5,443,400 A * 8/1995 Brown et al. 439/650
D372,702 S * 8/1996 Saner D13/139.8
D435,516 S * 12/2000 Stekelenburg D13/139.8
D440,942 S * 4/2001 Ewing et al. D13/139.1

D483,331 S * 12/2003 Adachi et al. D13/139.7
D514,520 S * 2/2006 Bahramian D13/147
7,275,942 B1 * 10/2007 Wu 439/145
7,371,121 B1 * 5/2008 Lee 439/650
D572,662 S * 7/2008 Haber D13/139.8
D591,239 S * 4/2009 Caplan D13/137.2
D594,823 S * 6/2009 Ho'o et al. D13/139.1

* cited by examiner

Primary Examiner—Jennifer Rivard

Assistant Examiner—Angela J Lee

(74) *Attorney, Agent, or Firm*—WPAT, P.C.; Anthony King;
Kay Yang

(57) **CLAIM**

The ornamental design for multi-plug socket, as shown and described.

DESCRIPTION

FIG. 1 is a perspective view of multi-plug socket showing my new design;

FIG. 2 is a front elevational view thereof;

FIG. 3 is a rear elevational view thereof;

FIG. 4 is a left side elevational view thereof;

FIG. 5 is a right side elevational view thereof;

FIG. 6 is a top plan view thereof;

FIG. 7 is a bottom plan view thereof; and,

FIG. 8 is another perspective view of the multi-plug socket showing my new design.

1 Claim, 8 Drawing Sheets

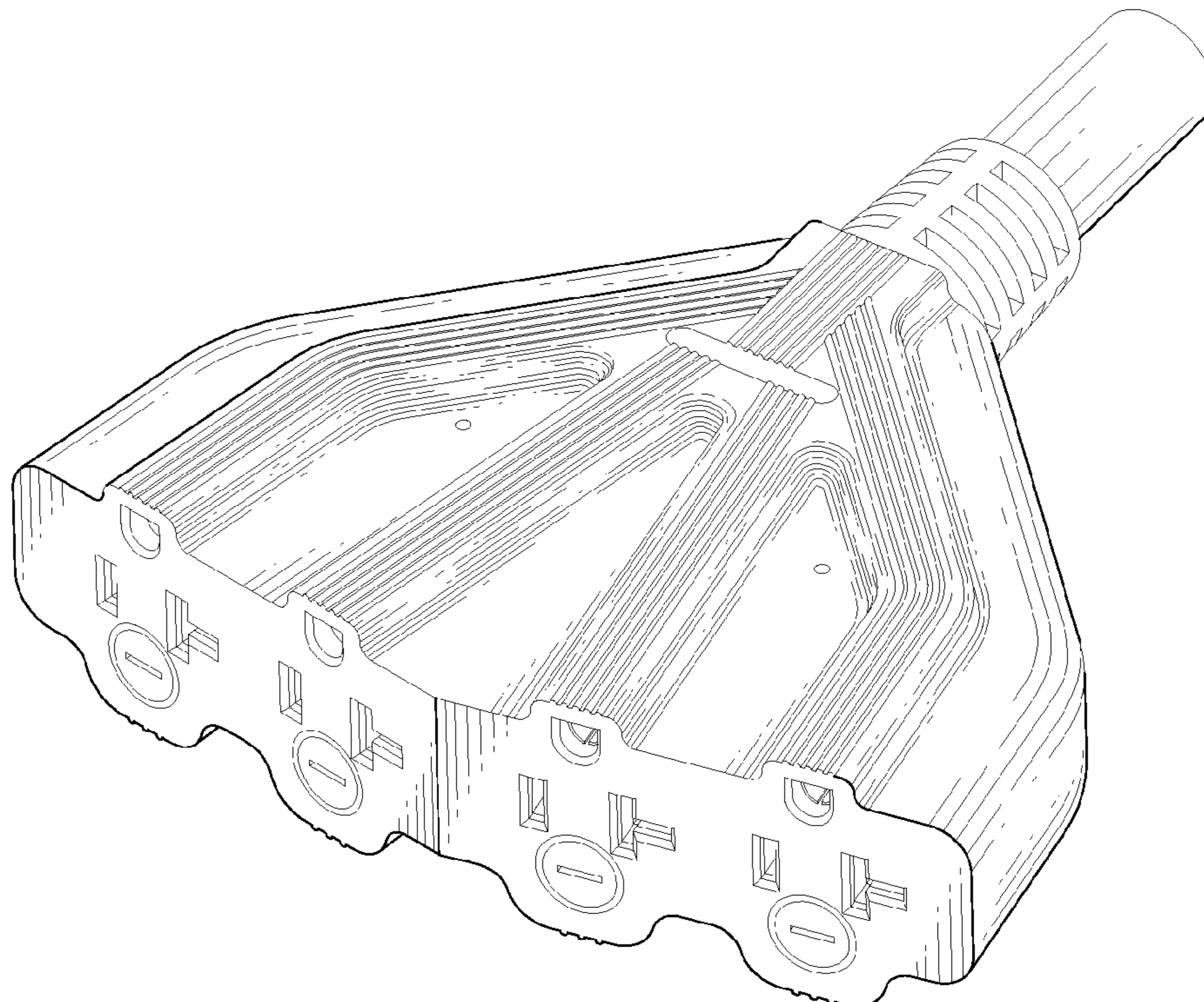

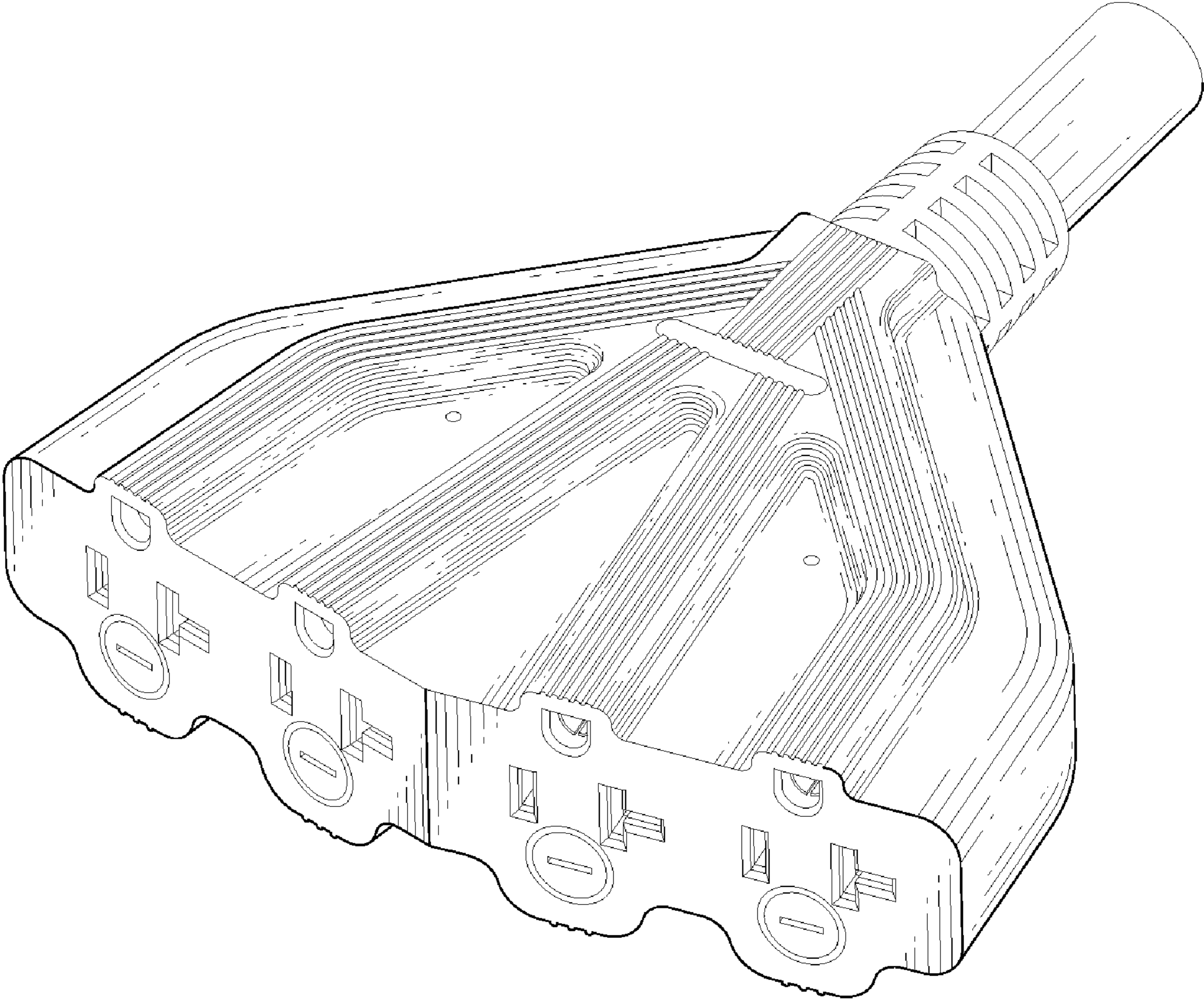

FIG. 1

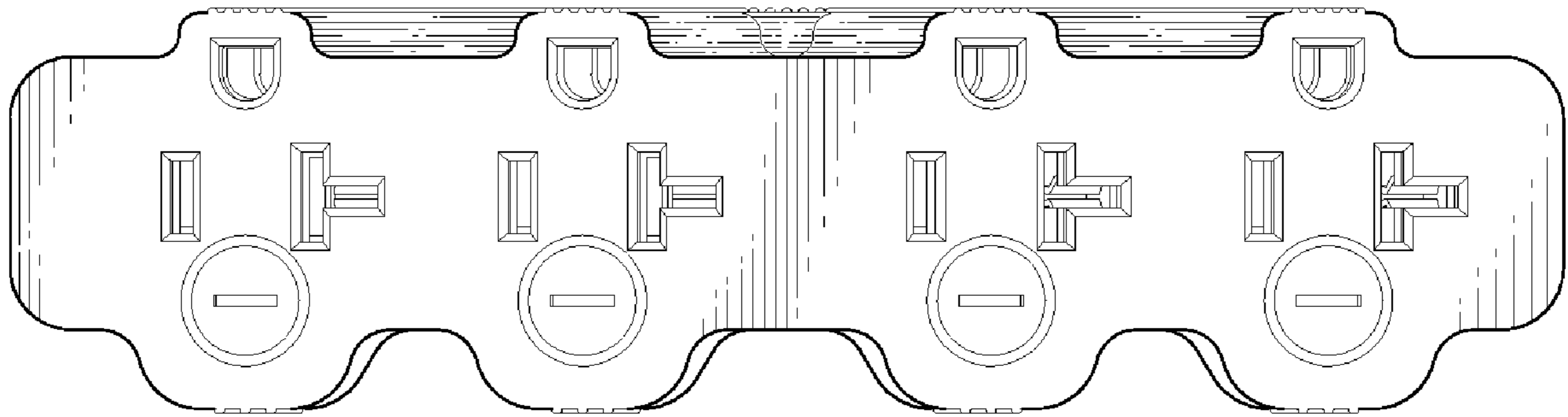

FIG. 2

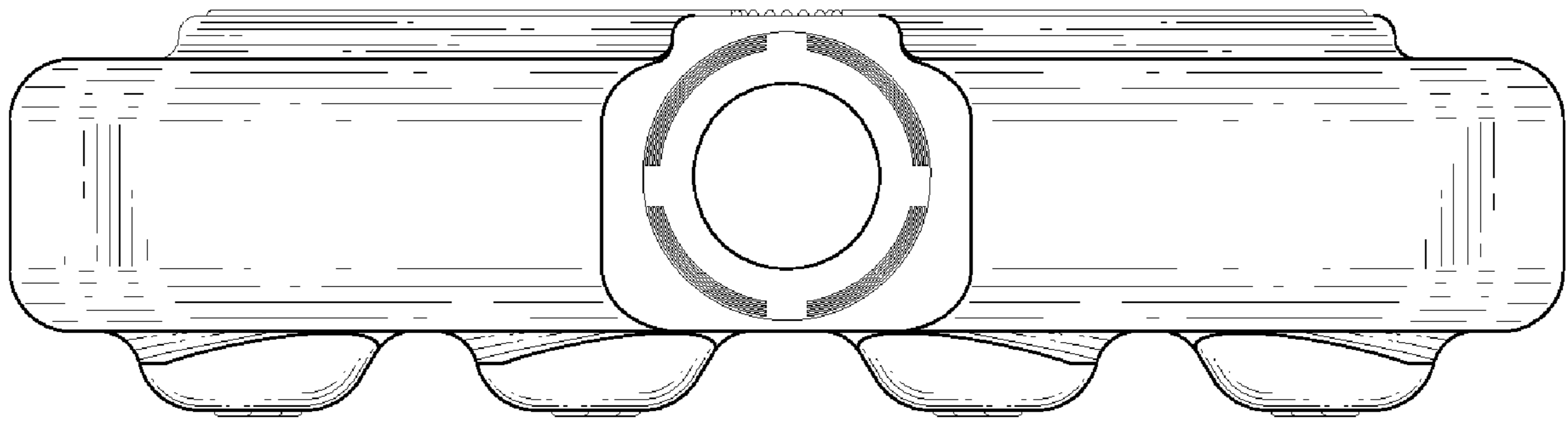

FIG. 3

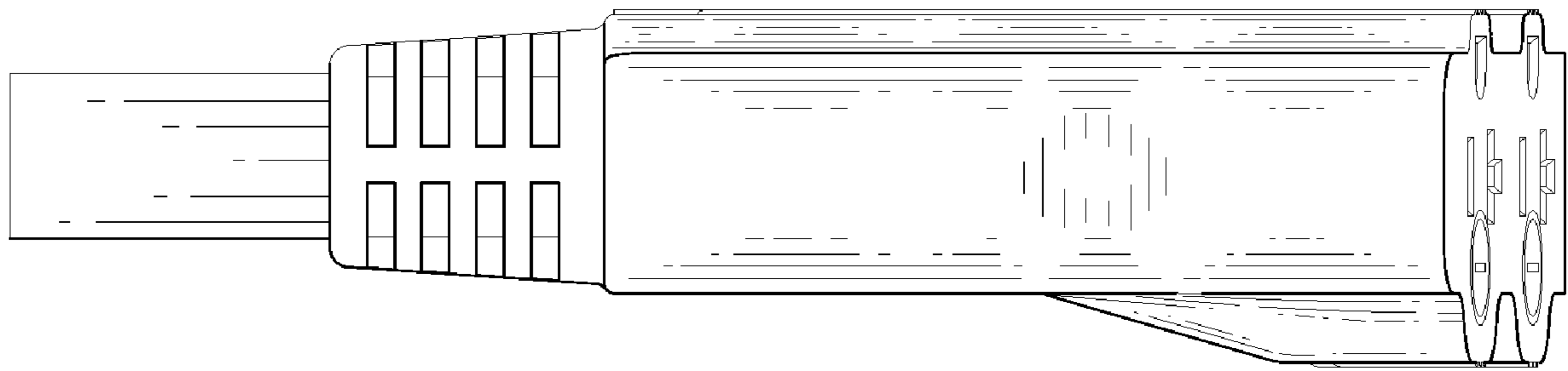

FIG. 4

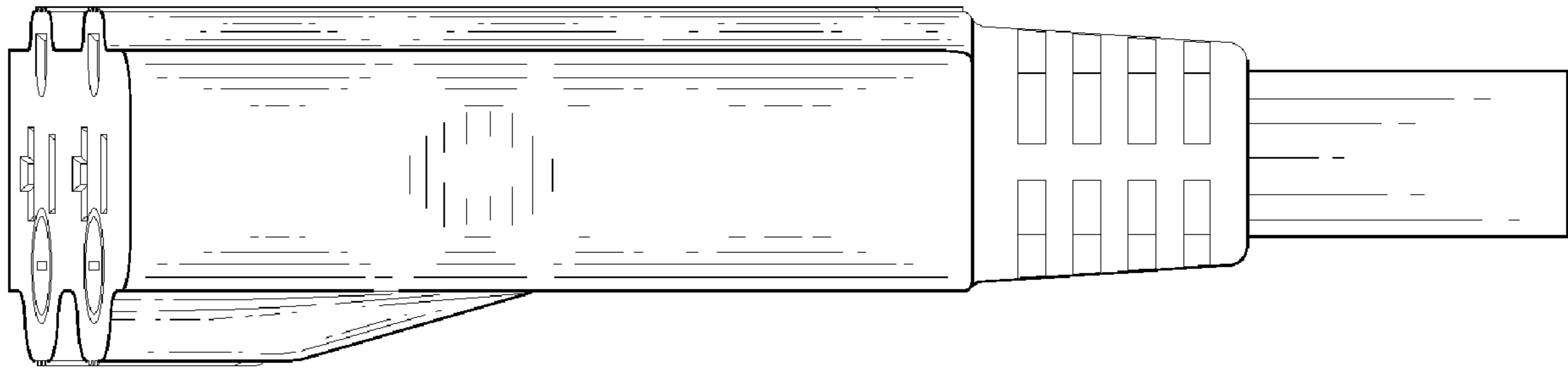

FIG. 5

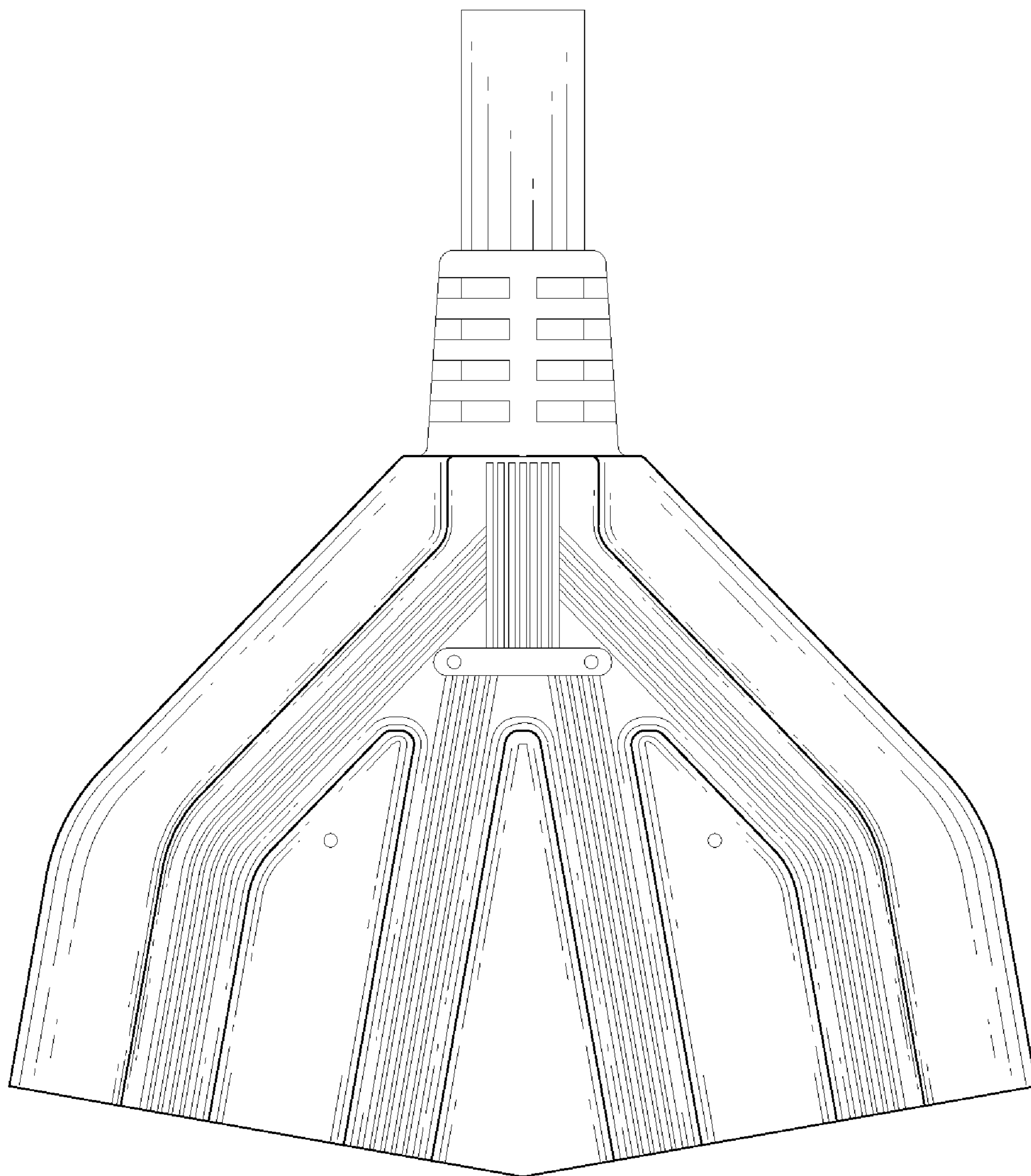

FIG. 6

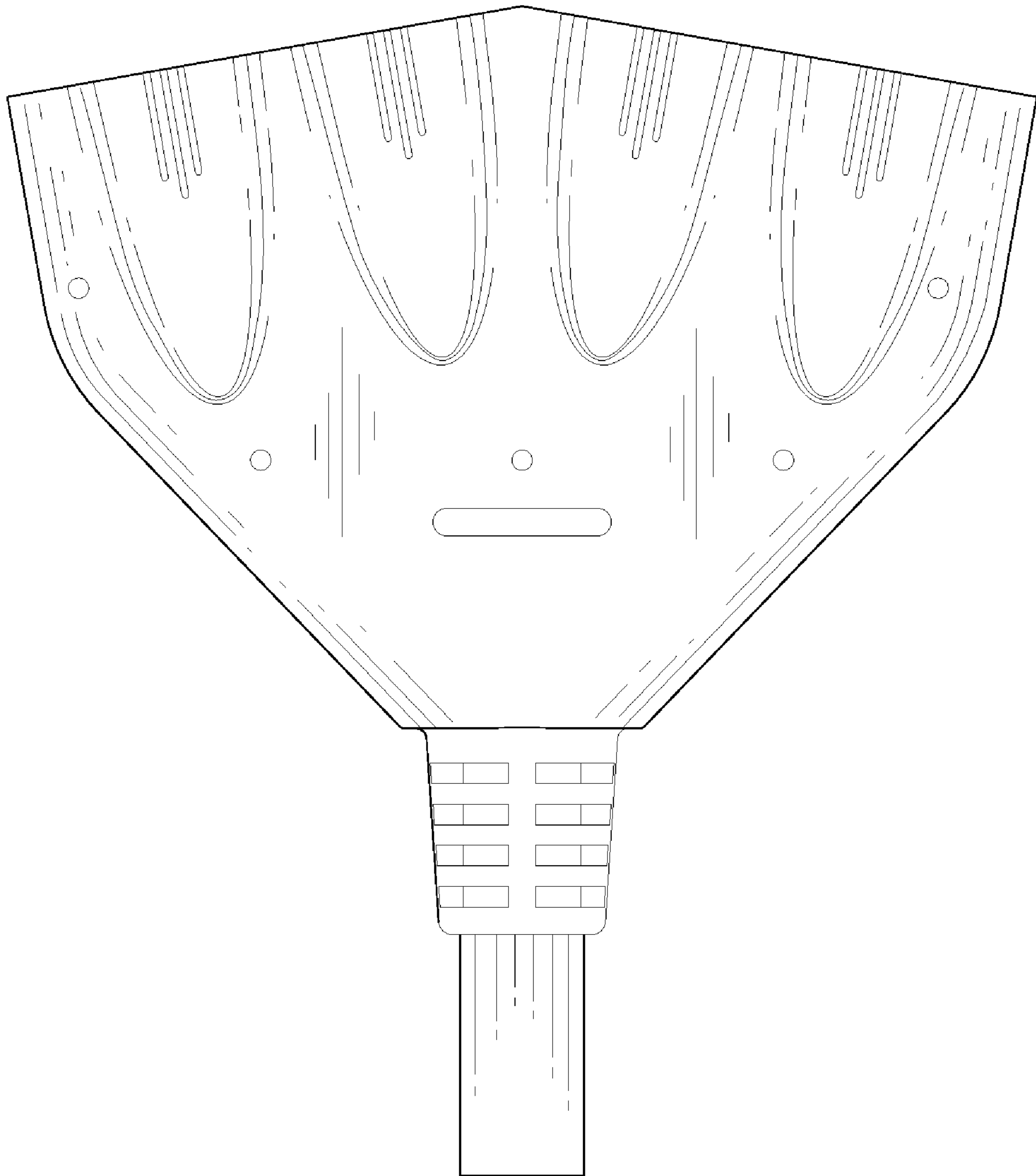

FIG. 7

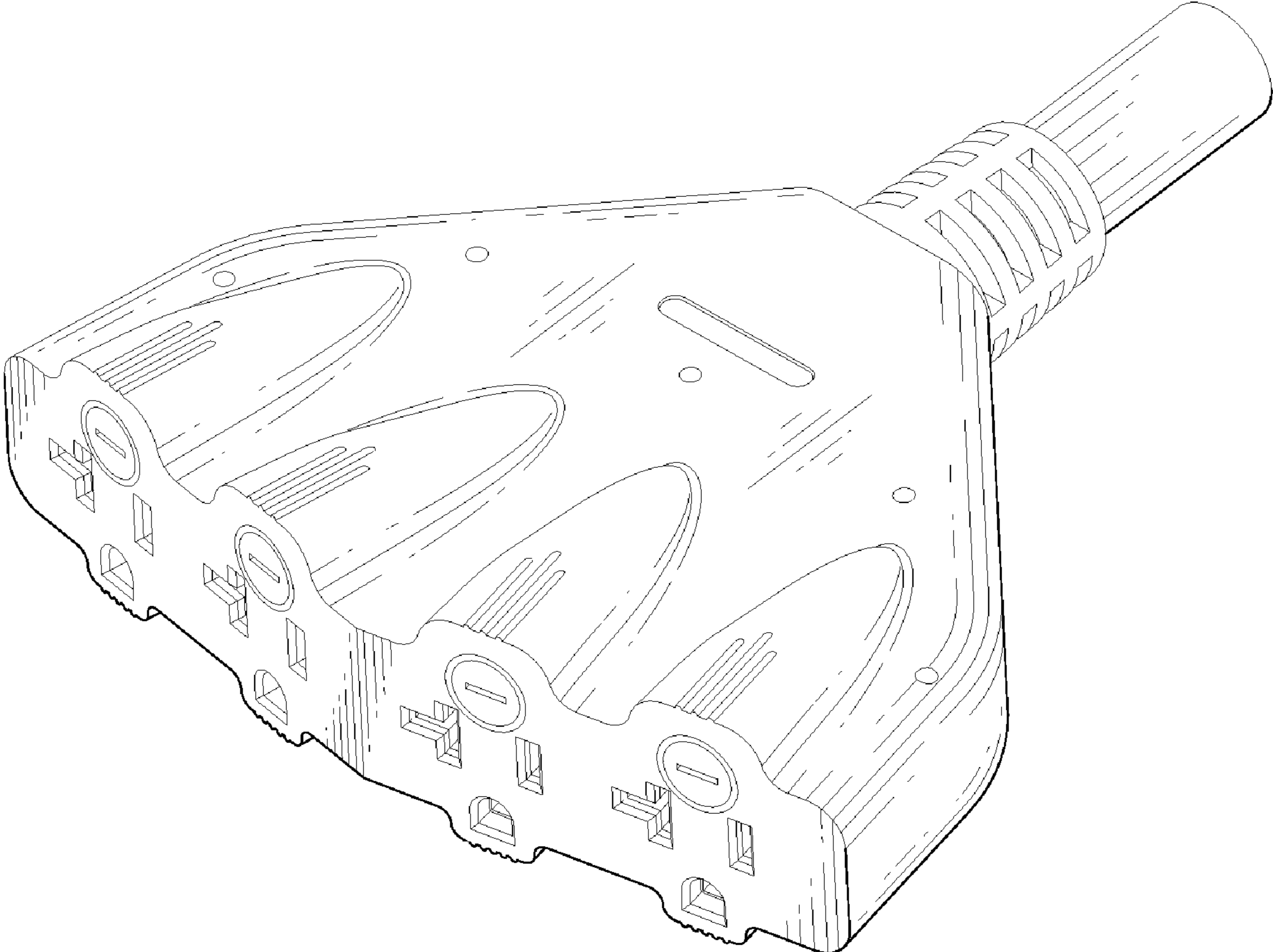

FIG. 8