



US00D612311S

(12) **United States Design Patent**
Weil

(10) **Patent No.:** **US D612,311 S**
(45) **Date of Patent:** **** Mar. 23, 2010**

(54) **SIDE MIRROR FOR A VEHICLE**

(75) Inventor: **Christopher Weil**, Munich (DE)

(73) Assignee: **Bayerische Motoren Werke Aktiengesellschaft**, Munich (DE)

(**) Term: **14 Years**

(21) Appl. No.: **29/311,934**

(22) Filed: **Jul. 31, 2009**

(30) **Foreign Application Priority Data**

Feb. 3, 2009 (DE) 402009000672

(51) **LOC (9) Cl.** **12-16**

(52) **U.S. Cl.** **D12/187**

(58) **Field of Classification Search** D12/187,
D12/188-189, 96; D6/300, 309; 359/838,
359/841, 843, 844, 868, 871, 604, 881, 514,
359/866; 248/479-483, 475.1

See application file for complete search history.

(56) **References Cited**

U.S. PATENT DOCUMENTS

D386,472	S	*	11/1997	Eisenbraun et al.	D12/187
6,106,122	A	*	8/2000	Gilbert et al.	359/841
6,217,181	B1	*	4/2001	Lynam et al.	359/879
D478,853	S	*	8/2003	Boyer	D12/187
D506,169	S	*	6/2005	Pfeiffer et al.	D12/187
6,929,300	B1	*	8/2005	Kuo	296/1.11
D519,071	S	*	4/2006	Moruzzi	D12/187
D579,838	S	*	11/2008	Habib	D12/187
D587,638	S	*	3/2009	Futschik et al.	D12/187
2004/0218272	A1	*	11/2004	Boddy	359/512
2005/0174645	A1	*	8/2005	Boddy et al.	359/599
2005/0195074	A1	*	9/2005	Kano	340/475

* cited by examiner

Primary Examiner—Caron Veynar
Assistant Examiner—Katrina A Kile
(74) *Attorney, Agent, or Firm*—Crowell & Moring LLP

(57) **CLAIM**

The ornamental design for a side mirror for a vehicle, as shown and described.

DESCRIPTION

FIG. 1 is a left side perspective view of a first embodiment of a side mirror for a vehicle according to my design;

FIG. 2 is a front, right perspective view thereof;

FIG. 3 is a front view thereof;

FIG. 4 is a rear view thereof;

FIG. 5 is a right side view thereof;

FIG. 6 is a left side view thereof;

FIG. 7 is a top, front perspective view thereof; and

FIG. 8 is a bottom view thereof.

FIG. 9 is a right side perspective view of a second embodiment of the side mirror for a vehicle according to my design;

FIG. 10 is a front, left perspective view thereof;

FIG. 11 is a front view thereof;

FIG. 12 is a rear view thereof;

FIG. 13 is a left side view thereof;

FIG. 14 is a right side view thereof;

FIG. 15 is a top, front perspective view thereof; and,

FIG. 16 is a bottom view thereof.

The second embodiment is a mirror image of the left side mirror for a vehicle as shown in FIGS. 1-8.

1 Claim, 10 Drawing Sheets

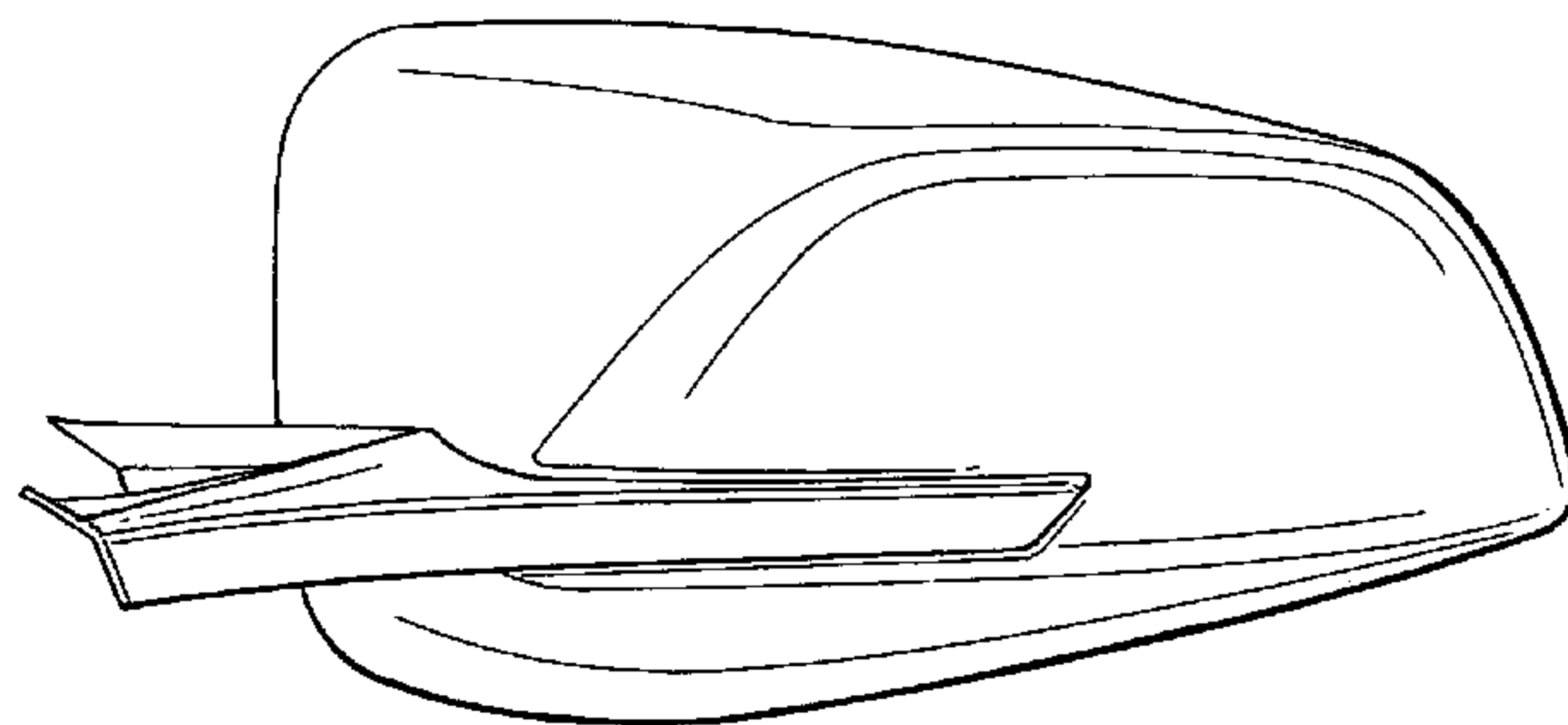
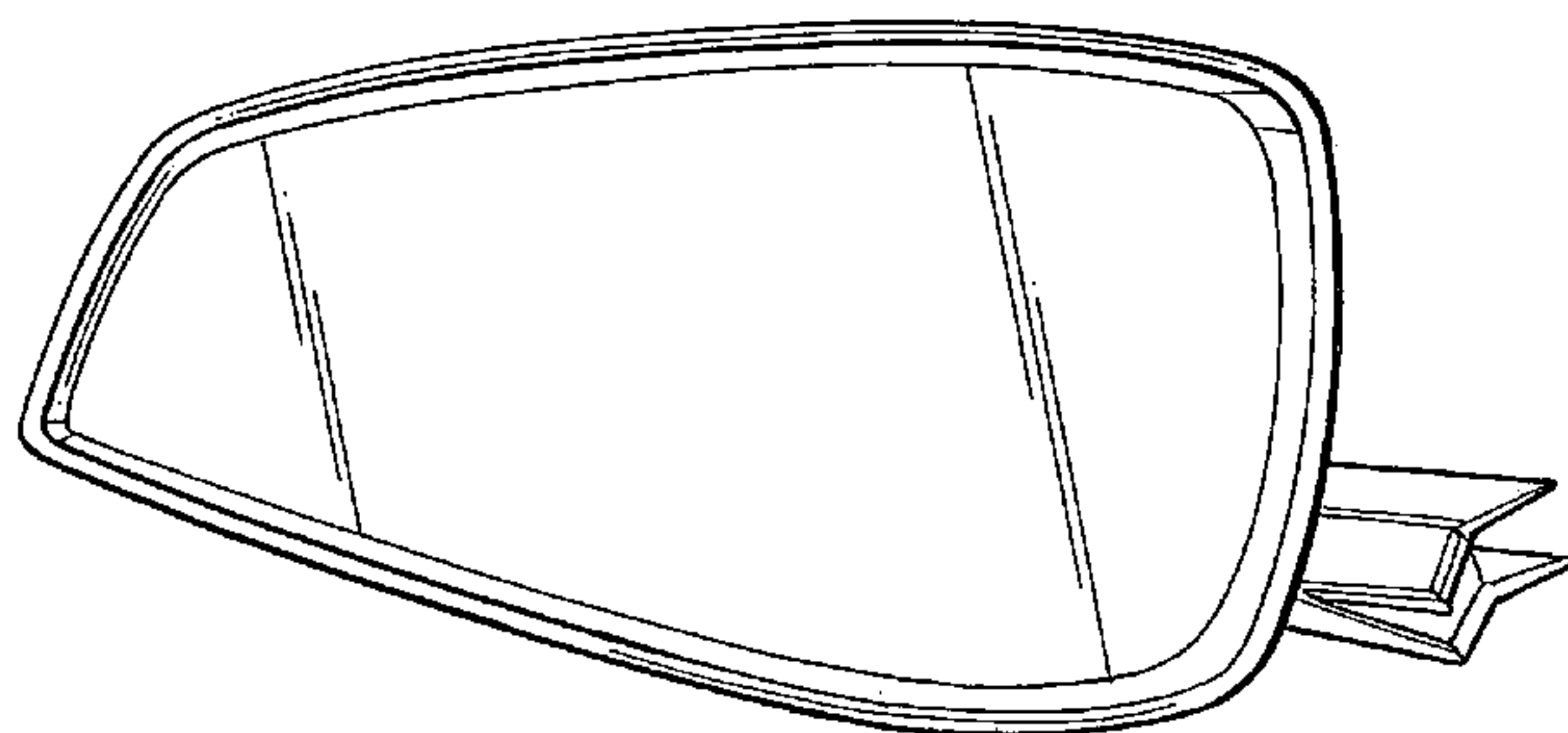

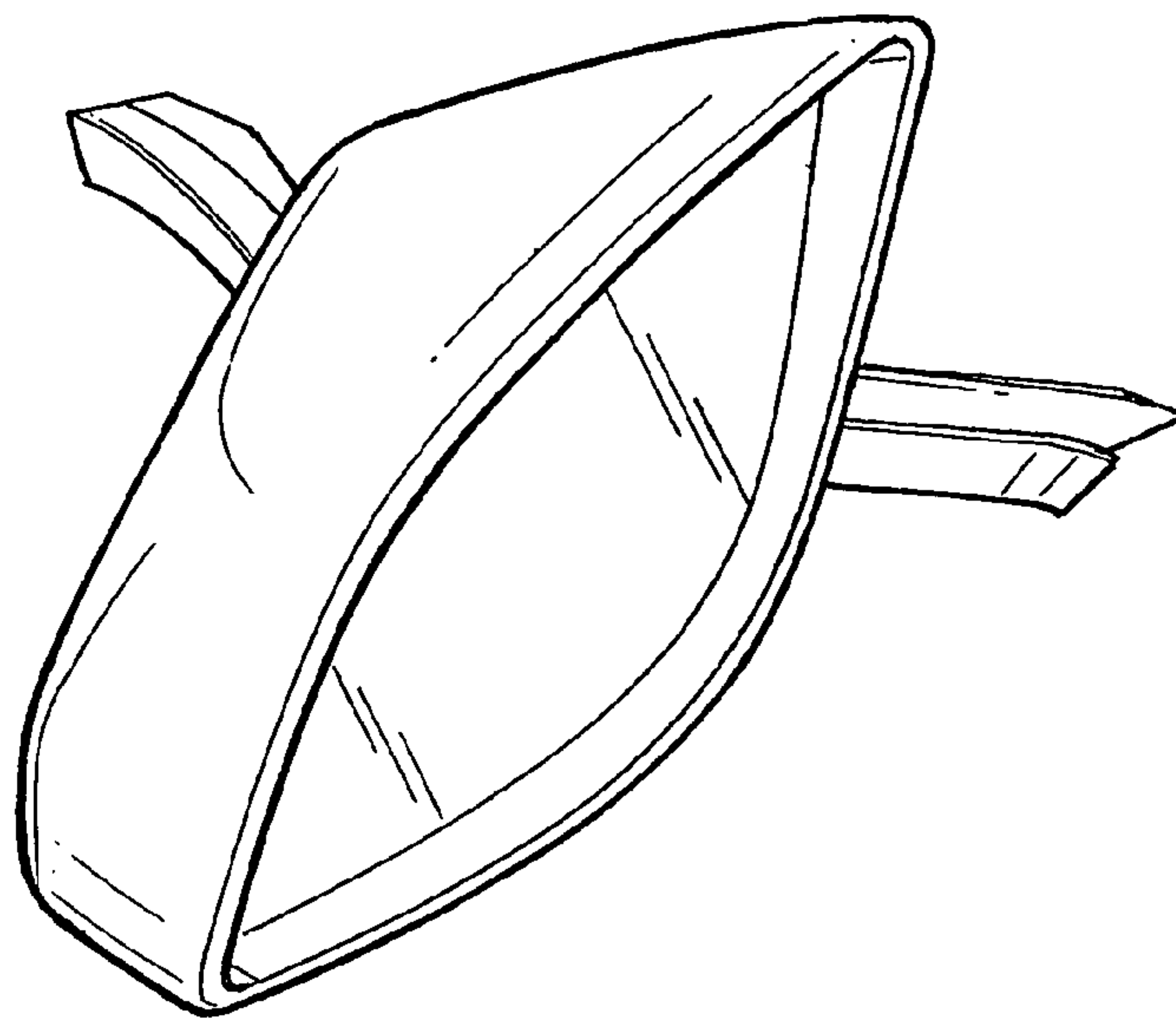

FIG. 1

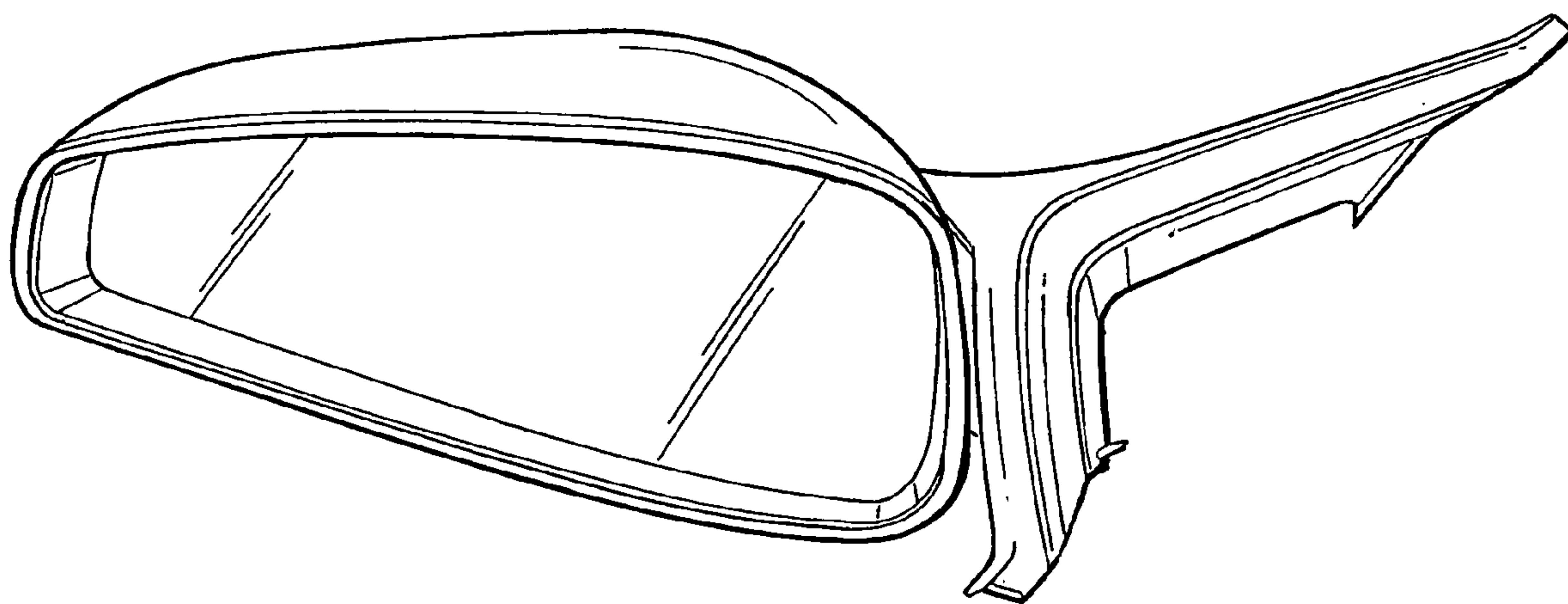

FIG. 2

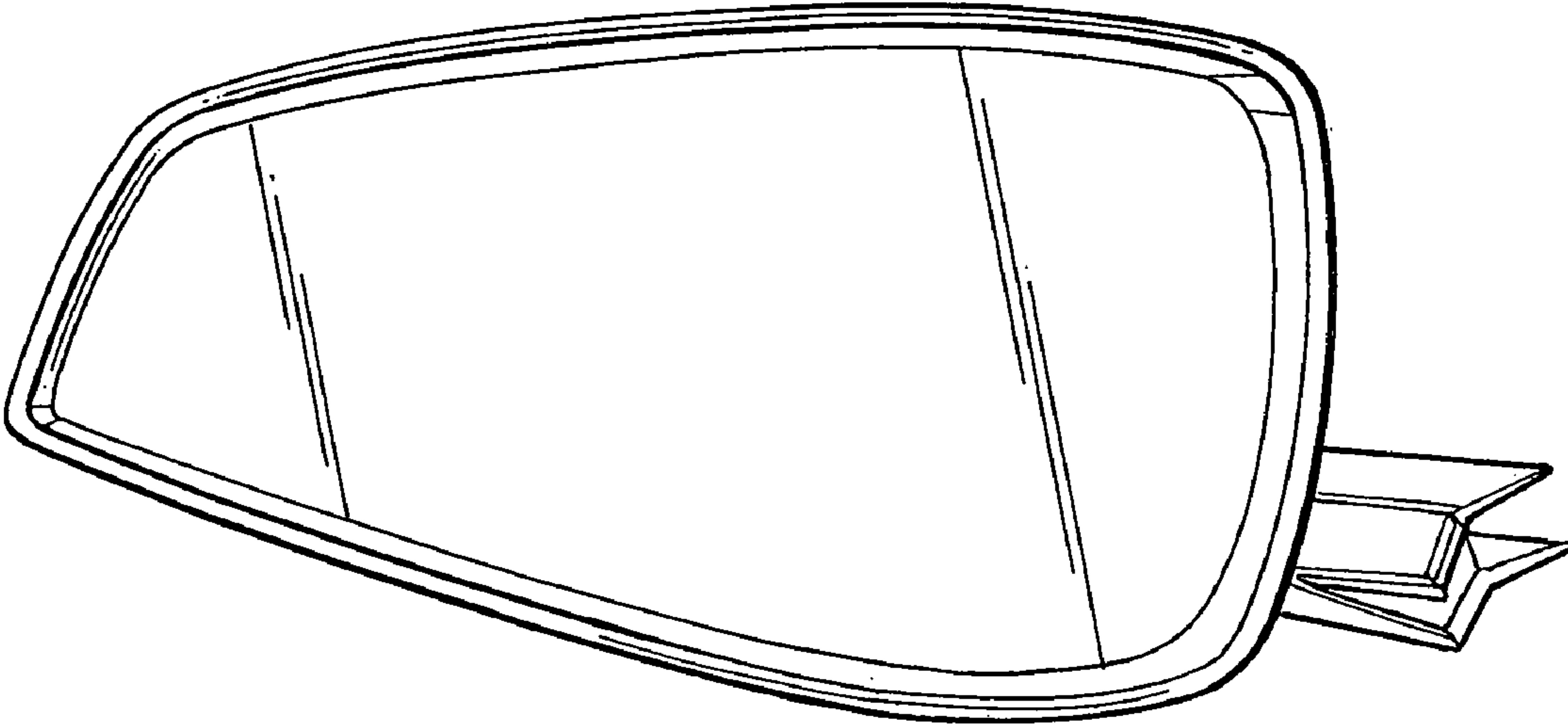

FIG. 3

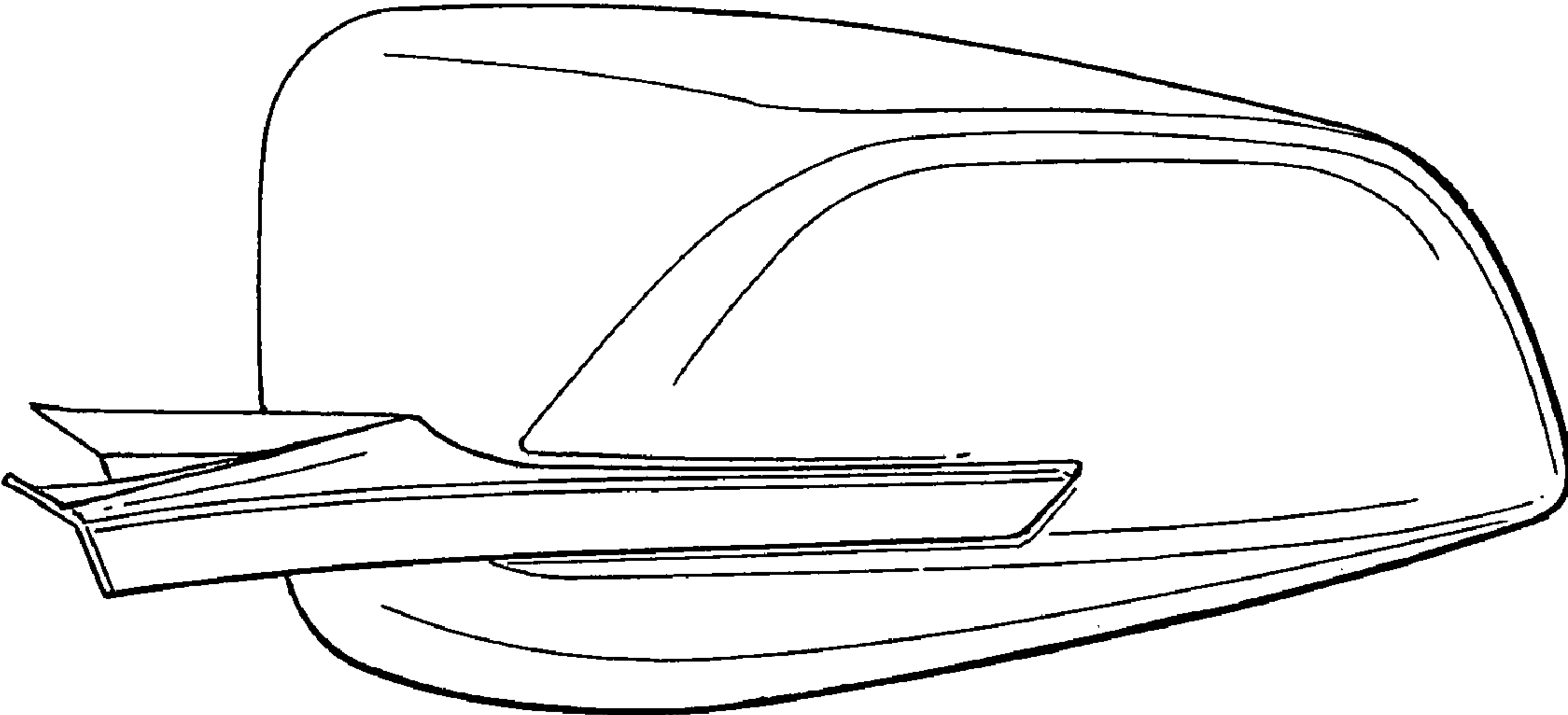

FIG. 4

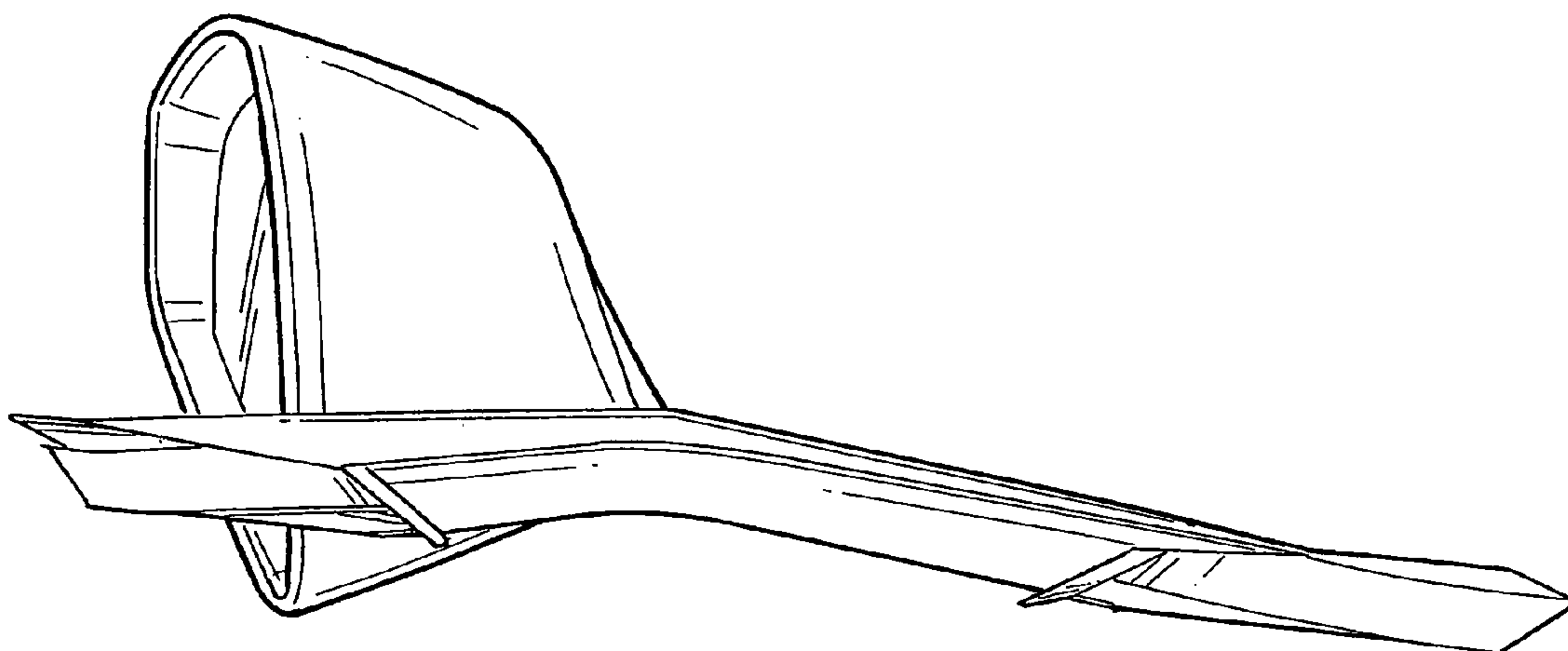

FIG. 5

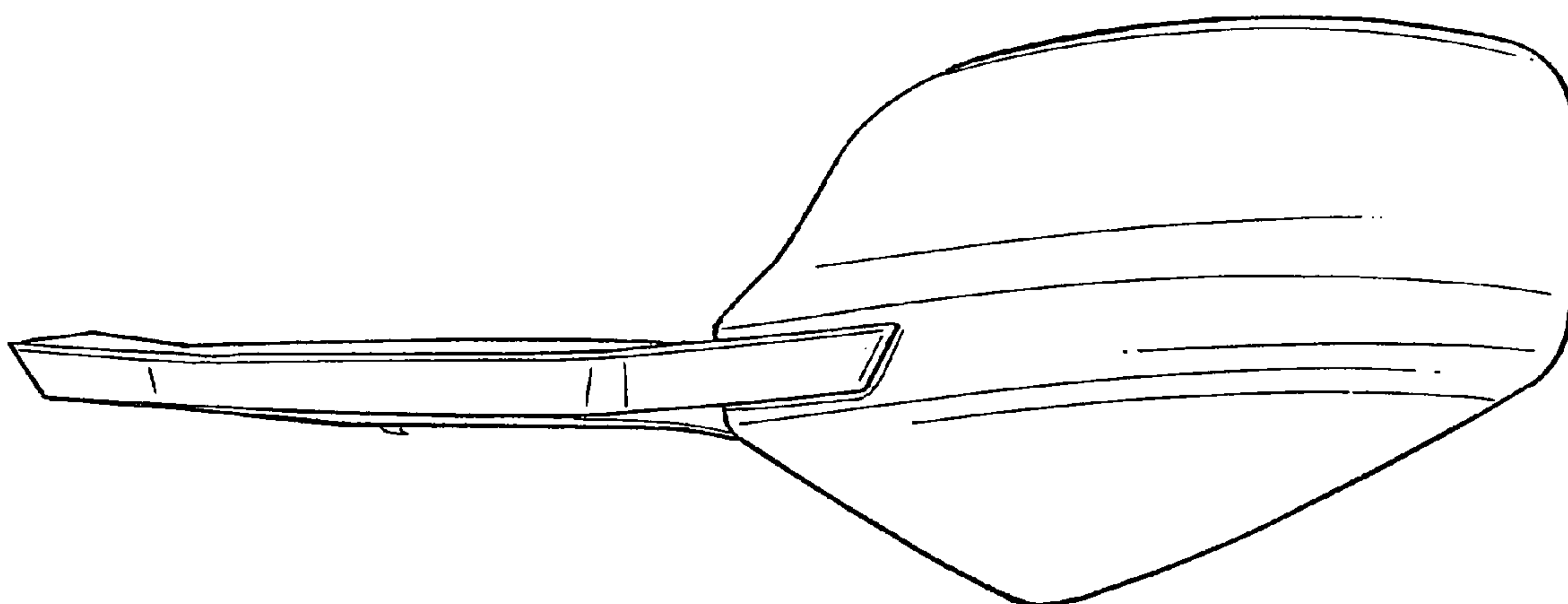

FIG. 6

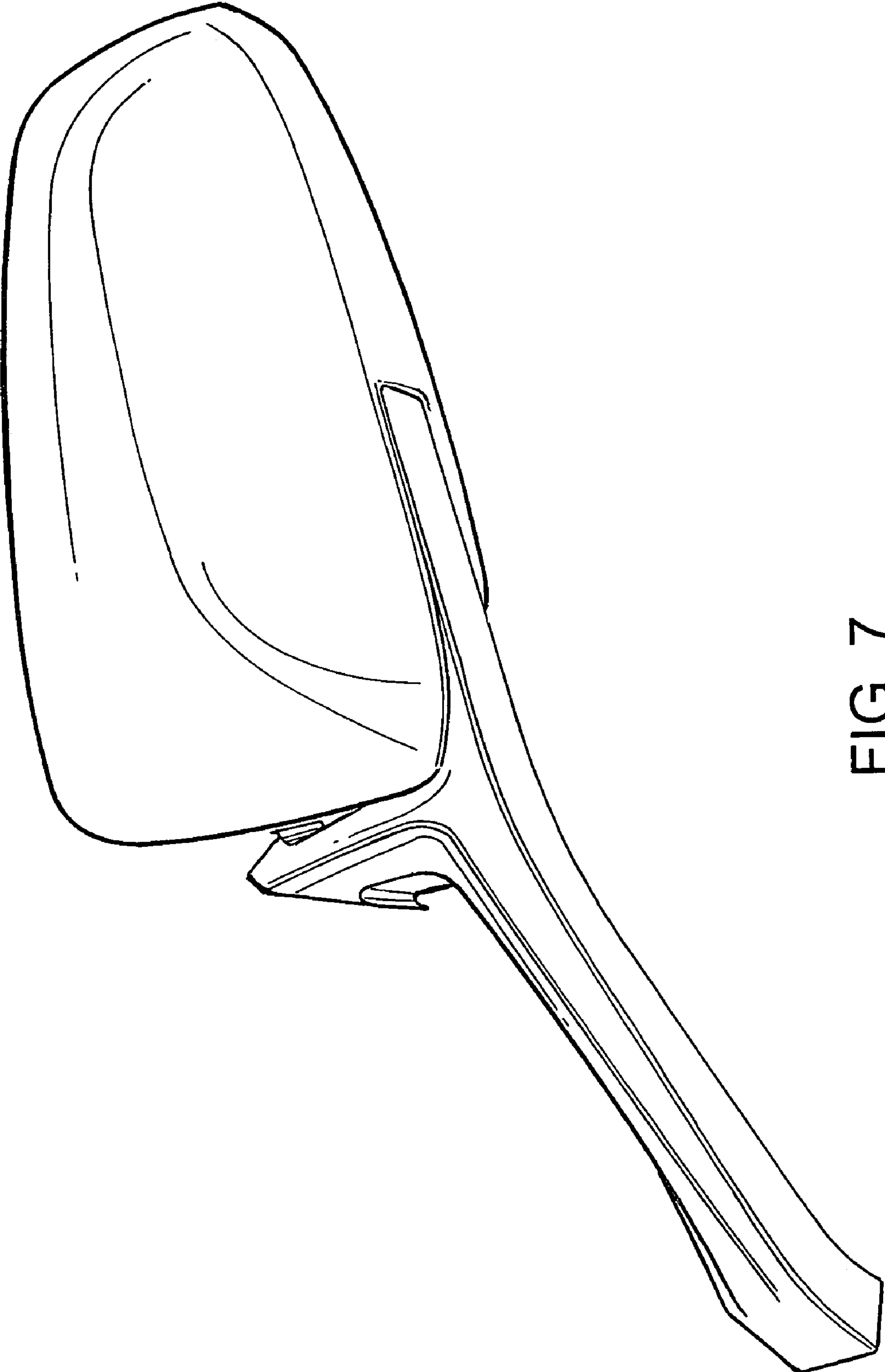

FIG. 7

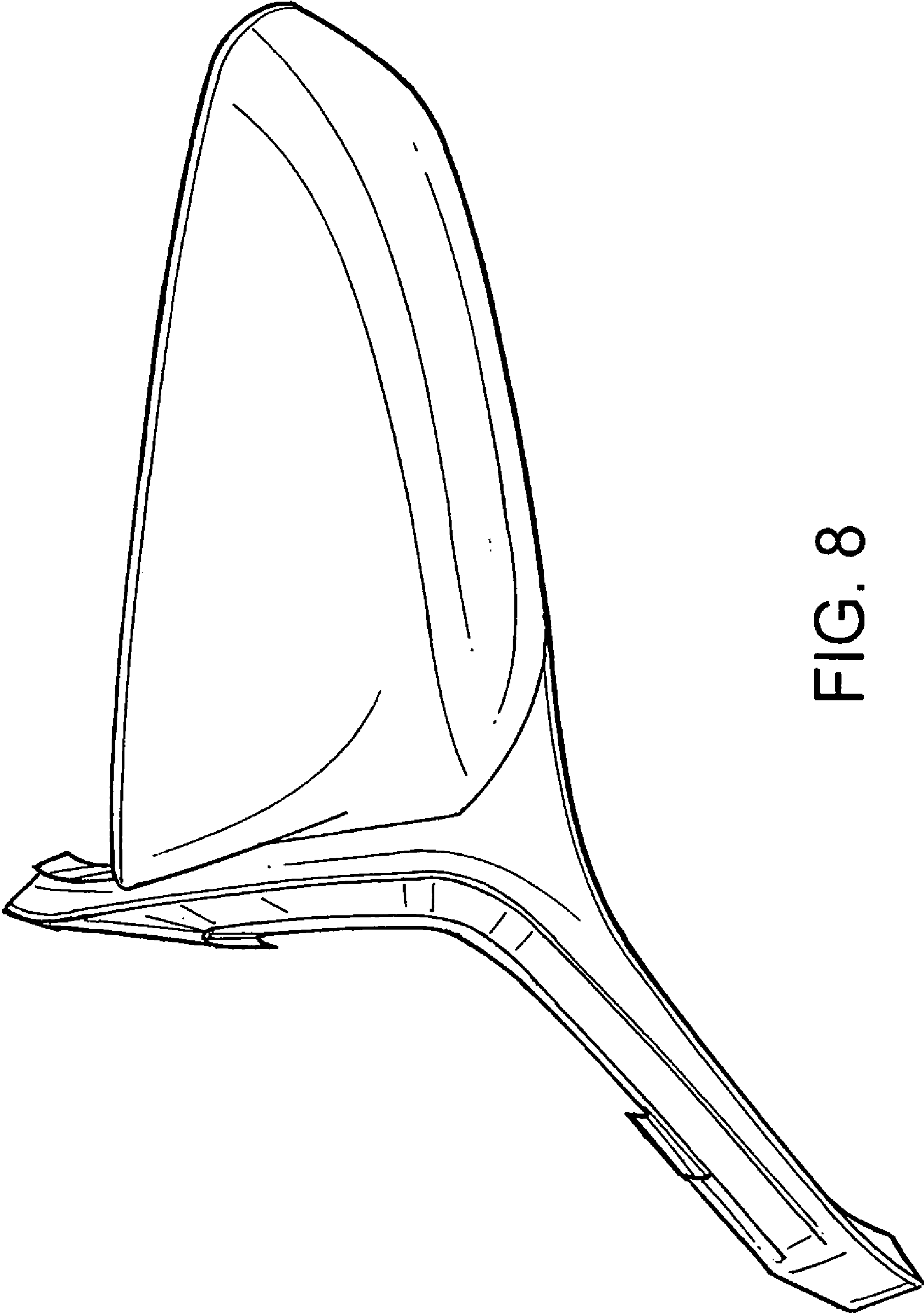

FIG. 8

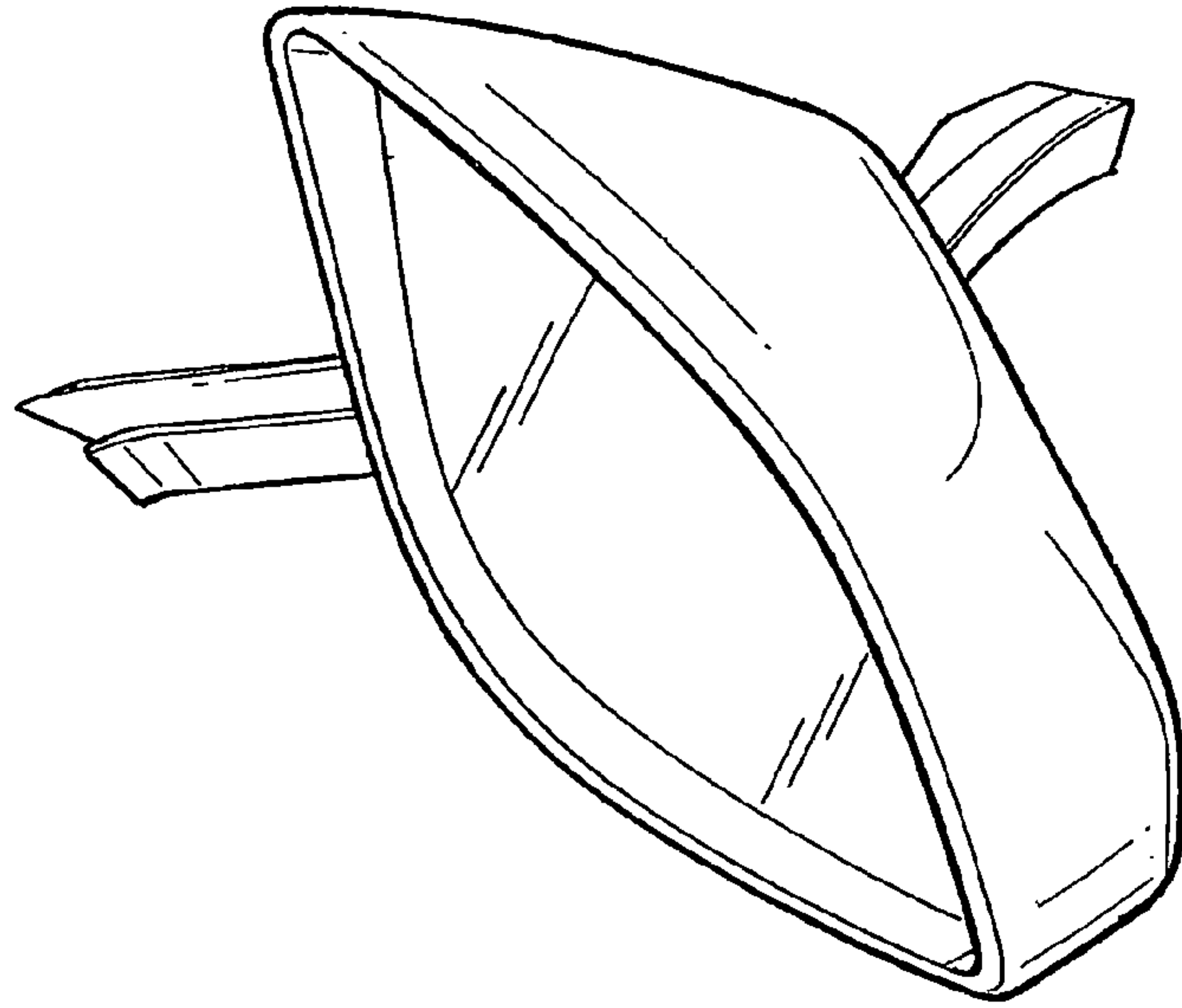

FIG. 9

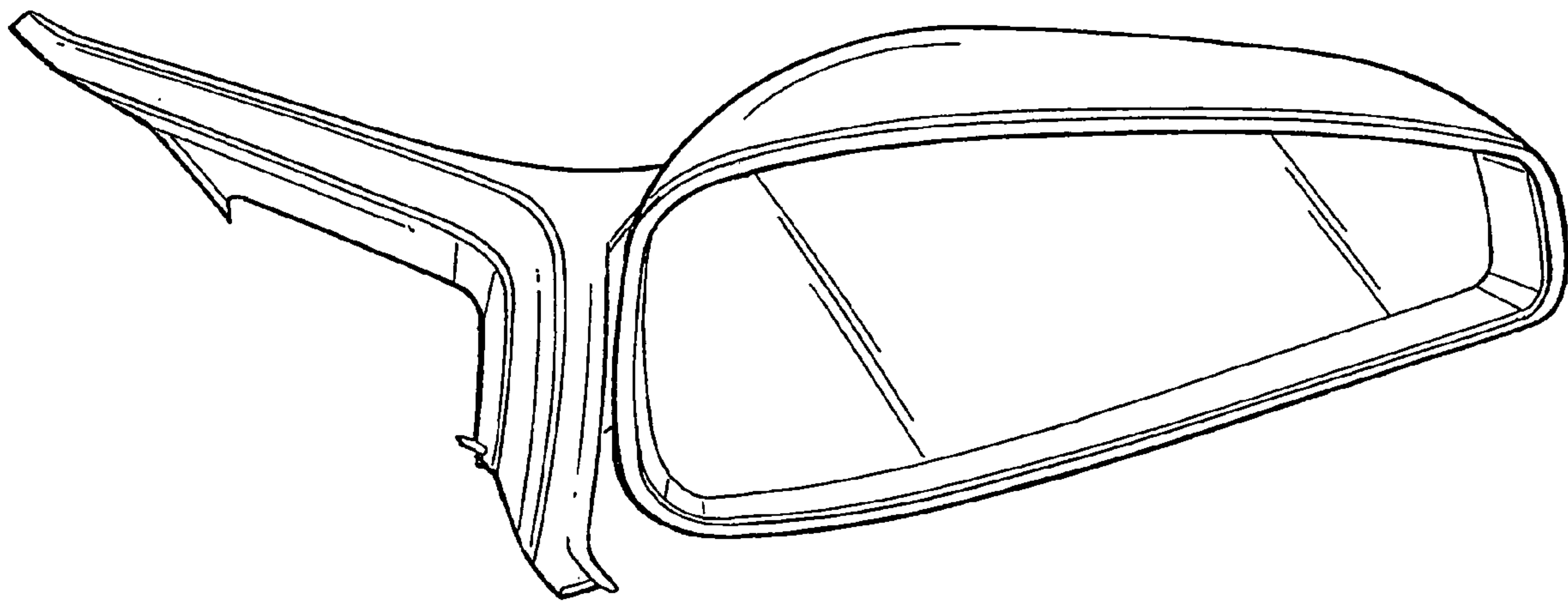

FIG. 10

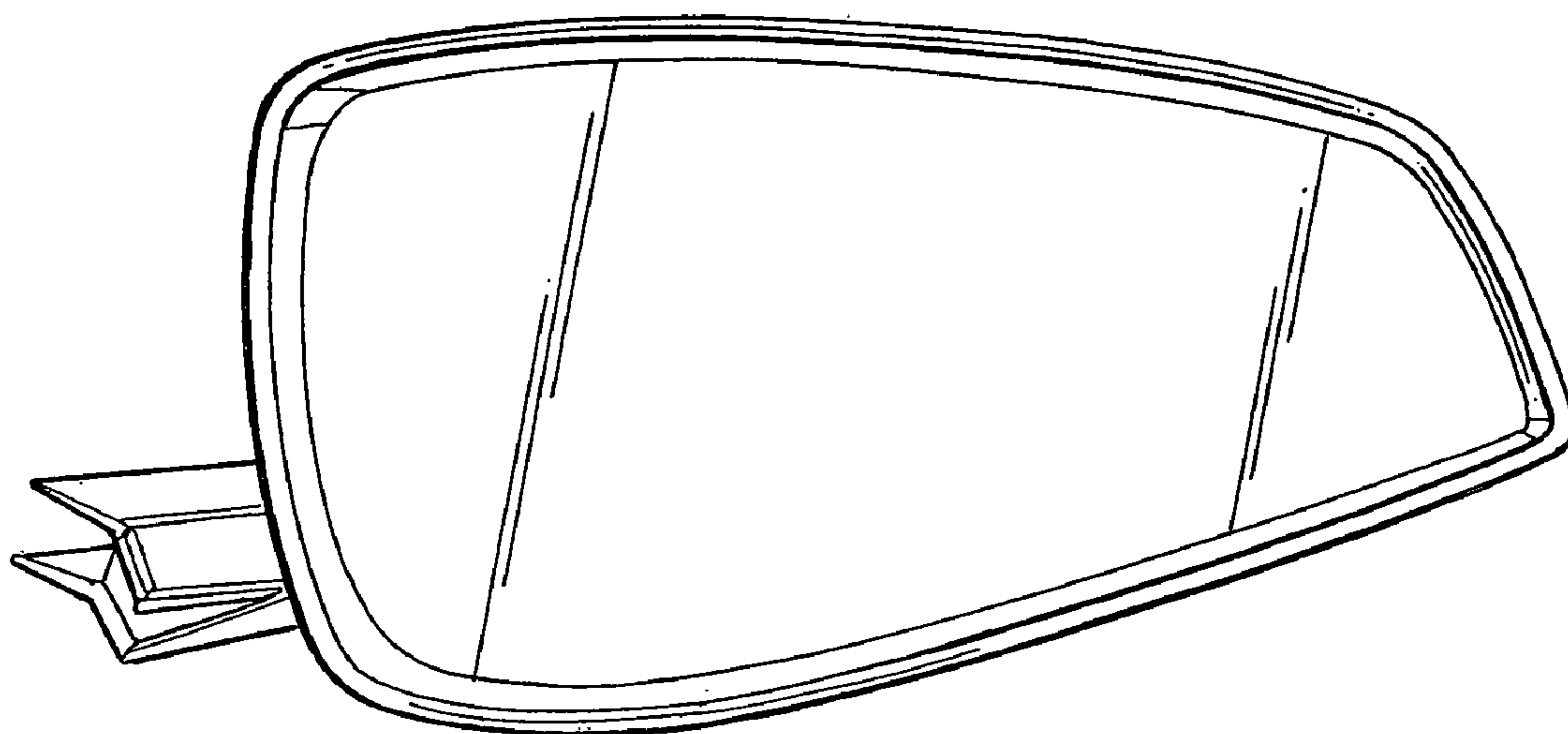

FIG. 11

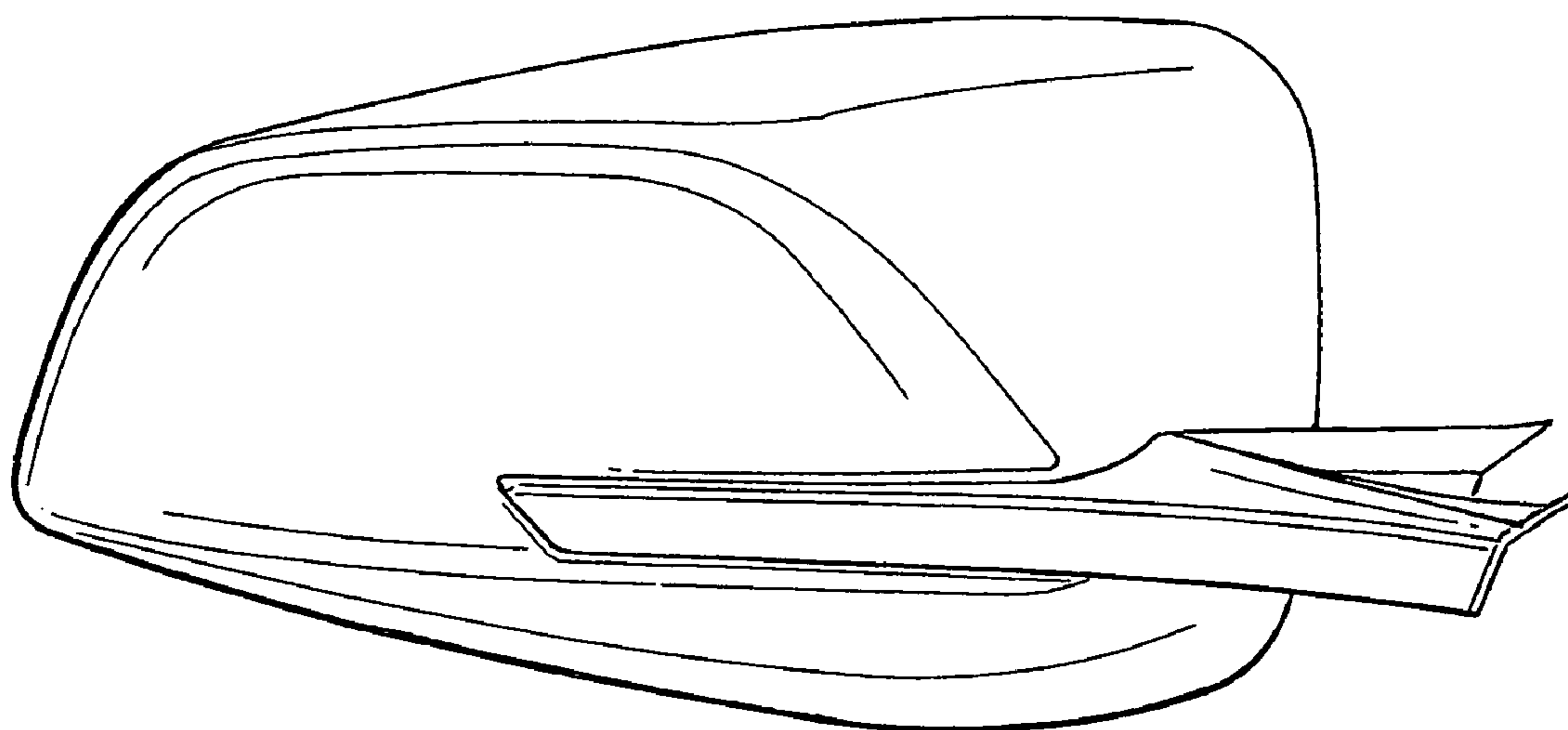

FIG. 12

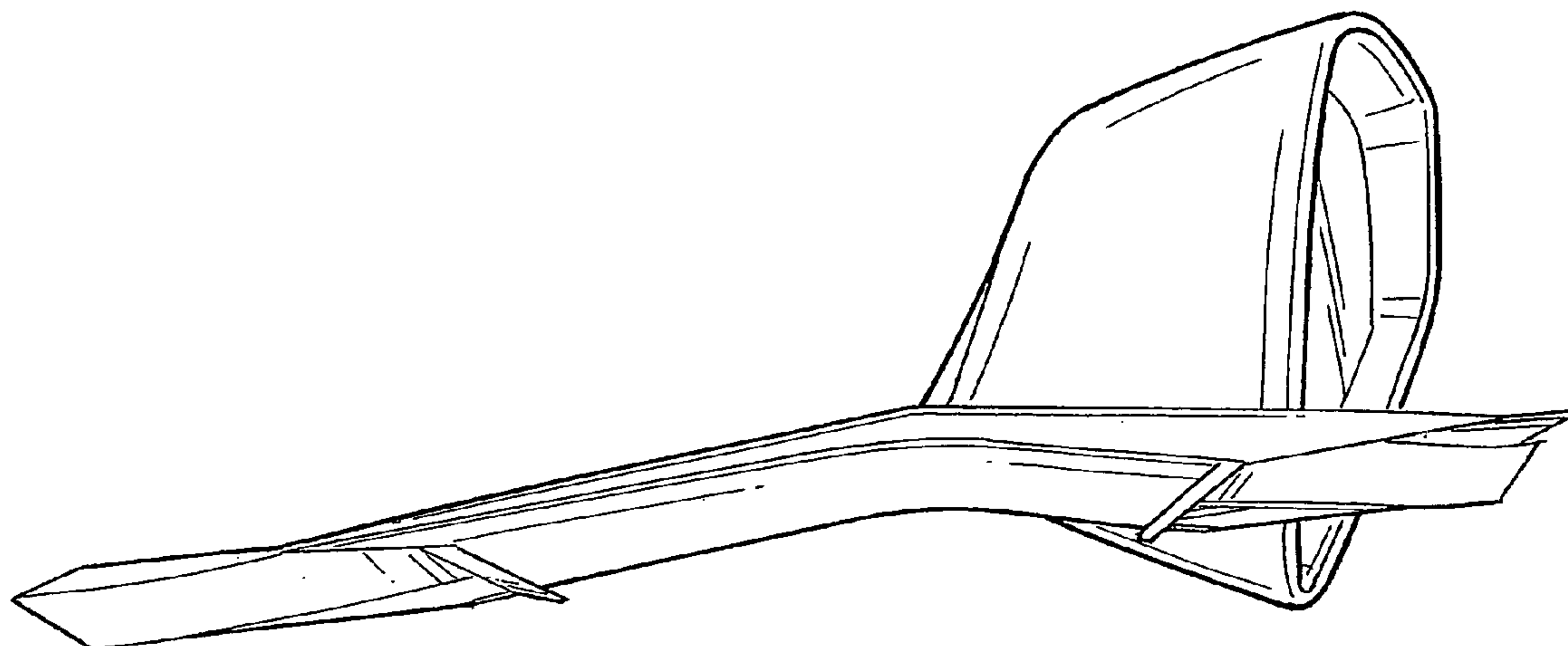

FIG. 13

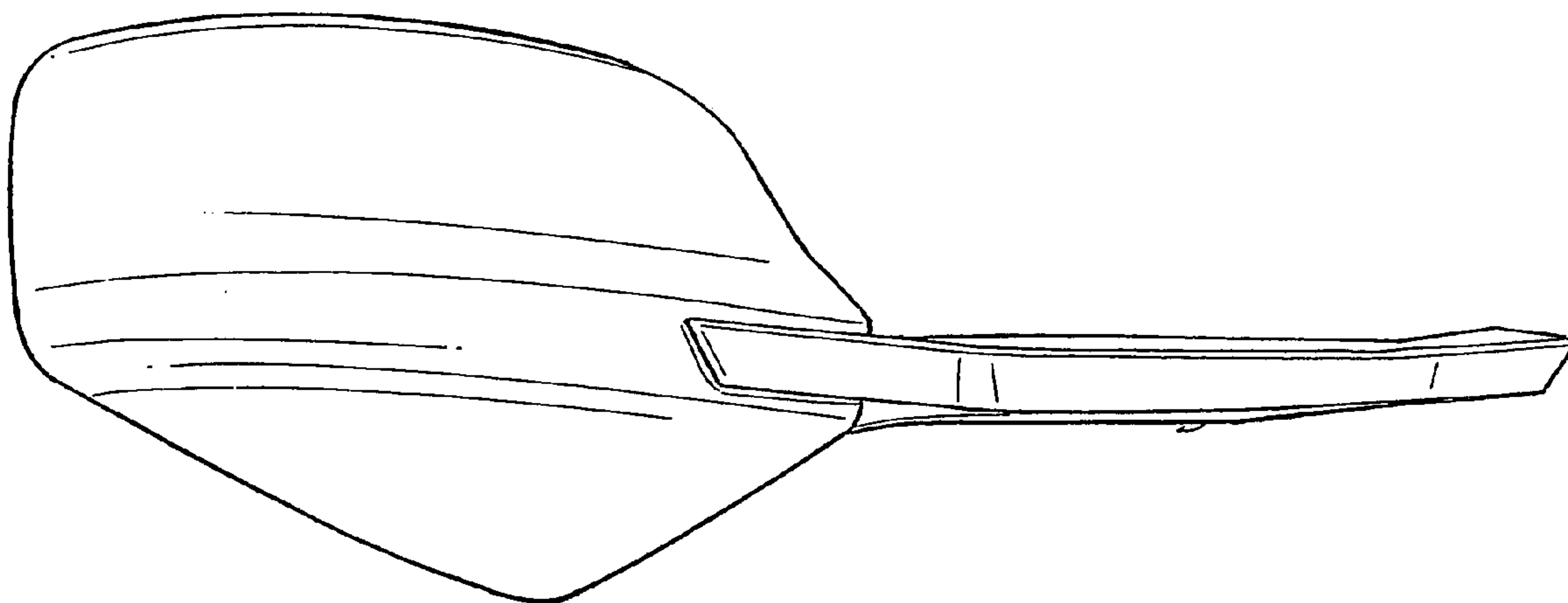

FIG. 14

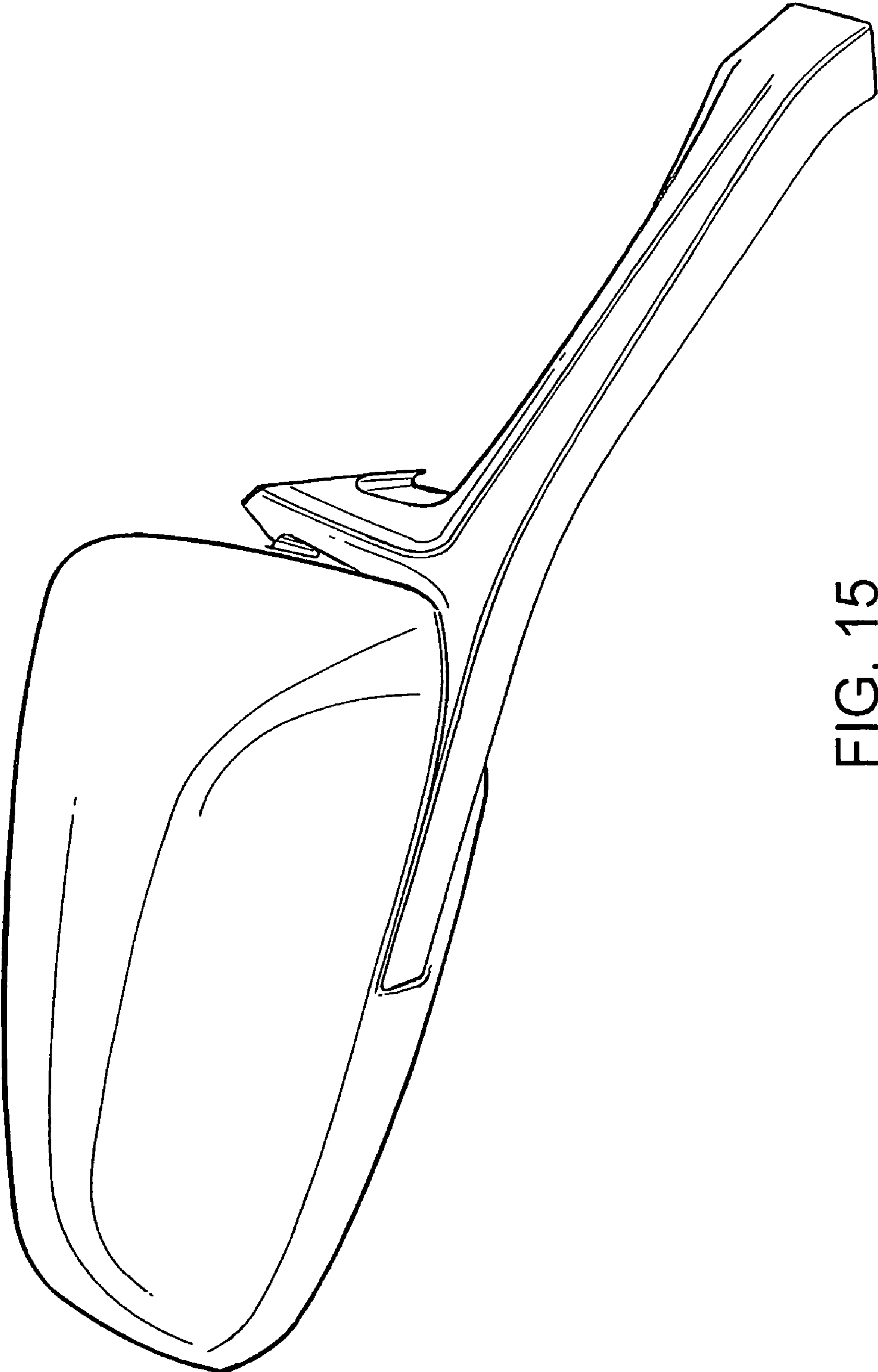

FIG. 15

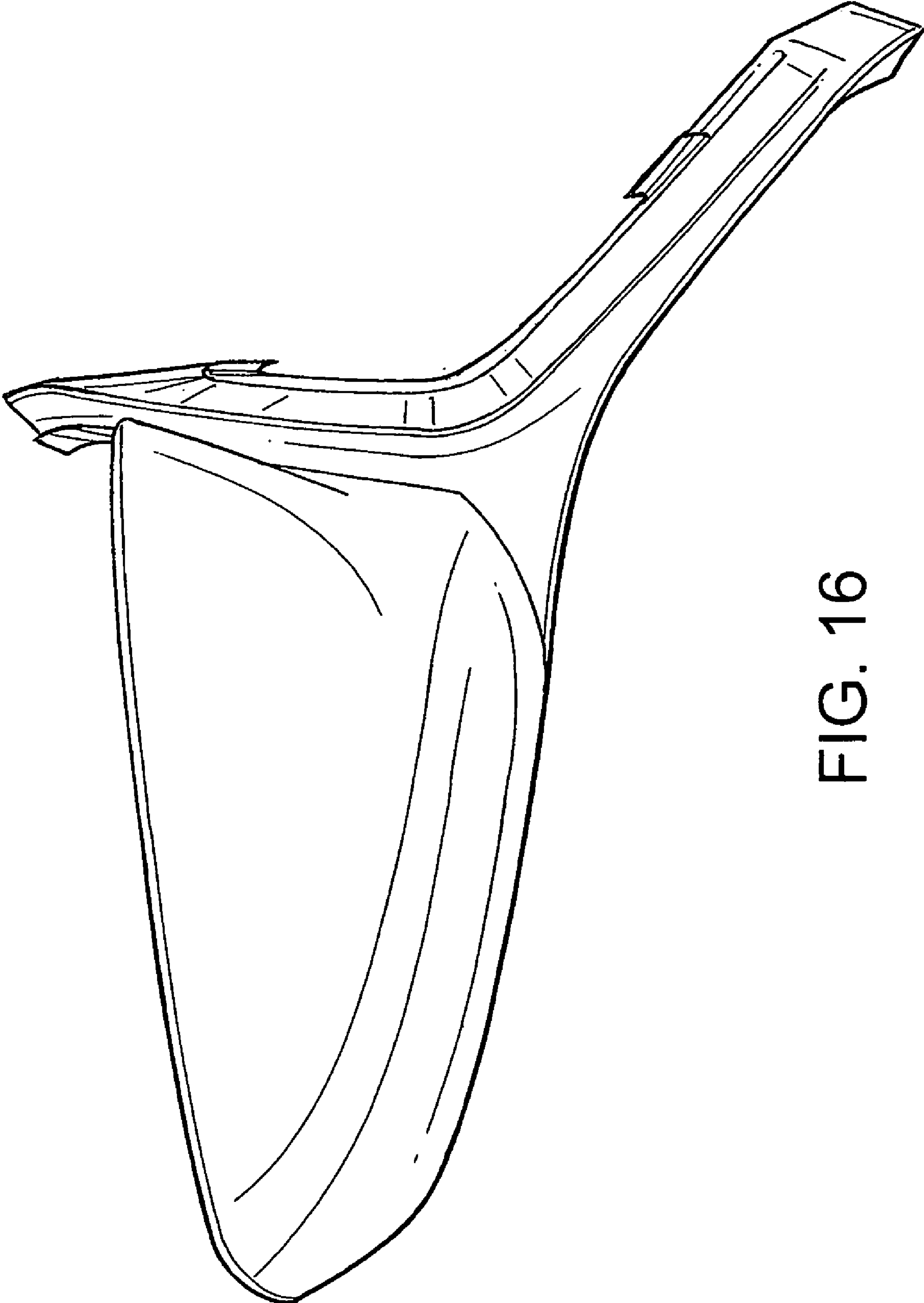

FIG. 16