



US00D612150S

(12) **United States Design Patent**
Overton

(10) **Patent No.:** **US D612,150 S**
(45) **Date of Patent:** **** Mar. 23, 2010**

(54) **EXPANDABLE POUCH COMBINED WITH BAND**

DESCRIPTION

(76) Inventor: **Kimberley Overton**, 1015 E. 3rd St., Austin, TX (US) 78702

(**) Term: **14 Years**

(21) Appl. No.: **29/330,217**

(22) Filed: **Dec. 31, 2008**

Related U.S. Application Data

(63) Continuation-in-part of application No. 29/303,645, filed on Feb. 13, 2008, and a continuation-in-part of application No. 12/030,034, filed on Feb. 12, 2008.

(51) **LOC (9) Cl.** **03-01**

(52) **U.S. Cl.** **D3/226**

(58) **Field of Classification Search** D3/226,
D3/224, 215, 230, 232; 224/224, 683–684,
224/587, 240–241, 660, 664, 677, 914; 383/59,
383/61, 61.2, 69, 85; D2/625–628

See application file for complete search history.

(56) **References Cited**

U.S. PATENT DOCUMENTS

D29,490 S 10/1898 Varni-Gardinier
5,060,835 A 10/1991 Payne
5,150,824 A 9/1992 Alvarez et al.
D334,471 S 4/1993 Yerby et al.

(Continued)

FOREIGN PATENT DOCUMENTS

GB 2241880 9/1991

Primary Examiner—Catherine R Oliver

(74) *Attorney, Agent, or Firm*—Robert L. Epstein; Epstein Drangel Bazerman & James, LLP

(57) **CLAIM**

I claim the ornamental design for the expandable pouch combined with band, as shown and described.

FIG. 1 is a front perspective view of an expandable pouch combined with band according to the present invention;

FIG. 2 is a rear perspective view thereof;

FIG. 3 is another front perspective view with the pouch shown filled;

FIG. 4 is a rear view of an empty pouch according to the present invention.

FIG. 5 is a rear view of an empty pouch according to the present invention with the pleats in the back fabric pushed slightly apart.

FIG. 6 is a rear view of a full pouch according to the present invention.

FIG. 7 is a front view of an empty pouch according to the present invention.

FIG. 8 is a front view of a full pouch according to the present invention.

FIG. 9 is a top plan view of an empty pouch according to the present invention;

FIG. 10 is a bottom plan view of an empty pouch according to the present invention;

FIG. 11 is a right side view of an empty pouch according to the present invention; and,

FIG. 12 is a left side view of an empty pouch according to the present invention.

The band is shown broken away in FIGS. 4–12 for convenience of illustration.

Components shown by broken lines are for illustrative purposes only and form no part of the claimed design.

The article in which the present design is embodied is a compact yet expandable pouch, formed from a single piece of elastic fabric and having pleats in the back, combined with a band for holding the pouch in place, for example around a wearer's arm or leg.

1 Claim, 8 Drawing Sheets

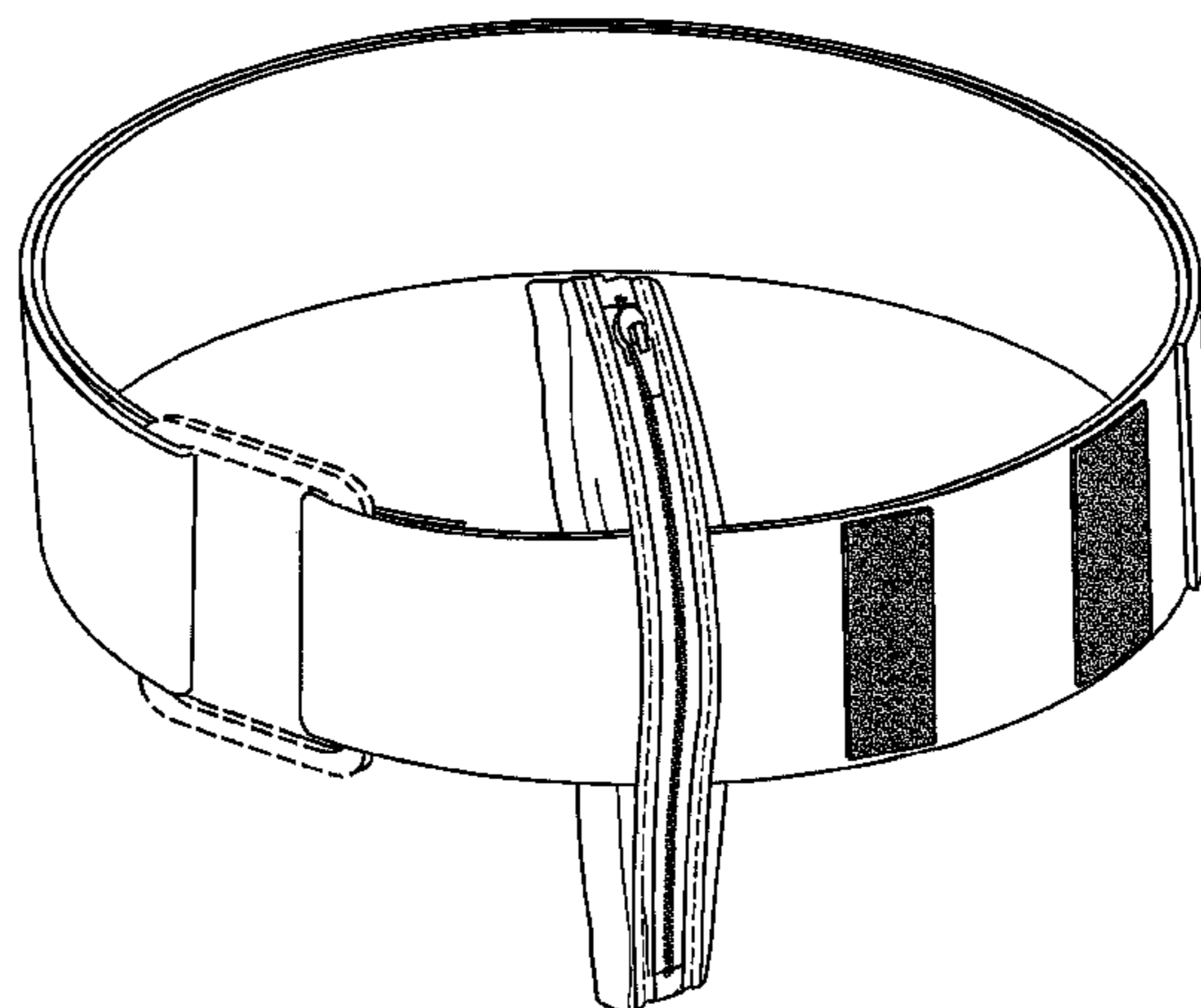

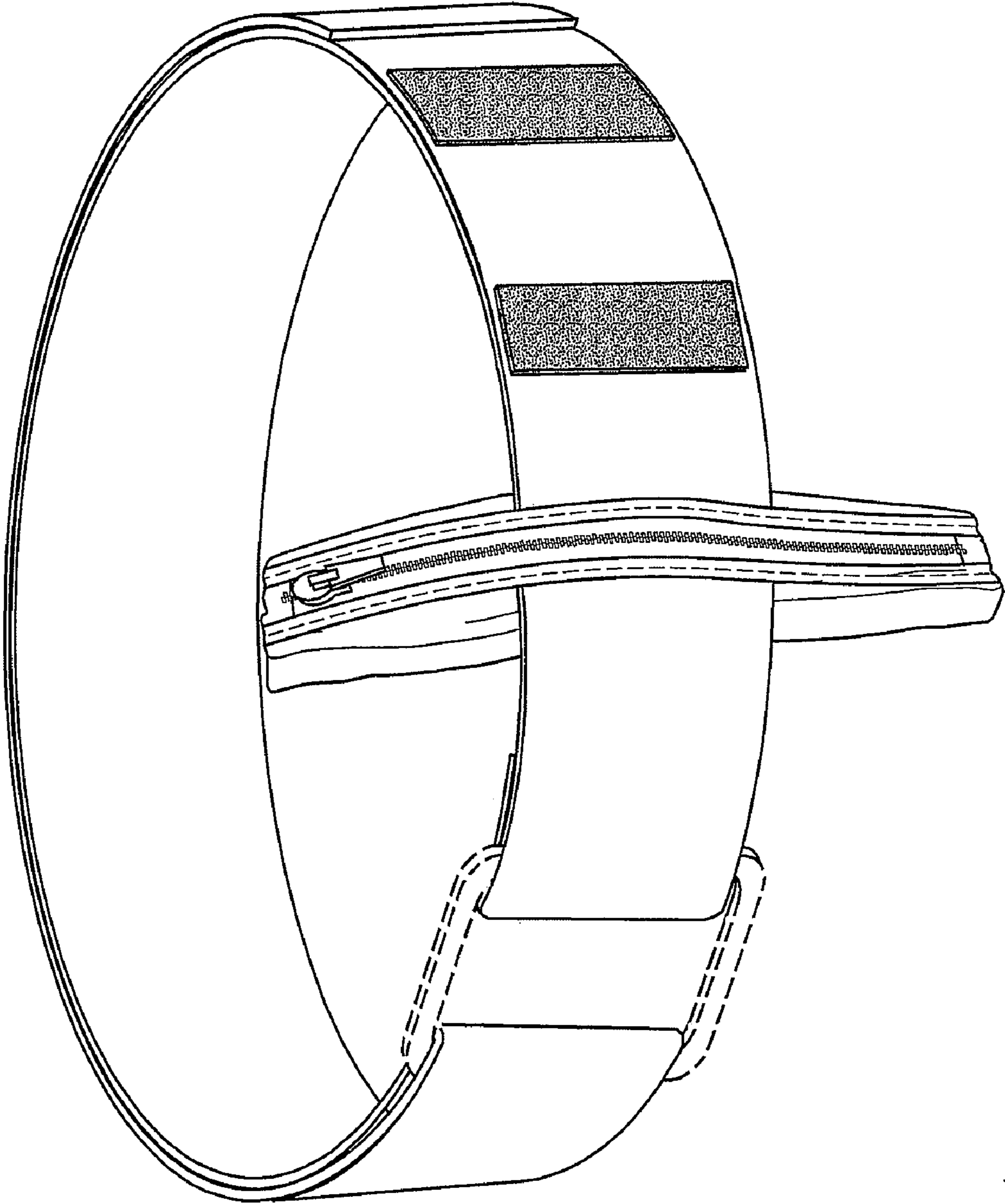

FIG. 1

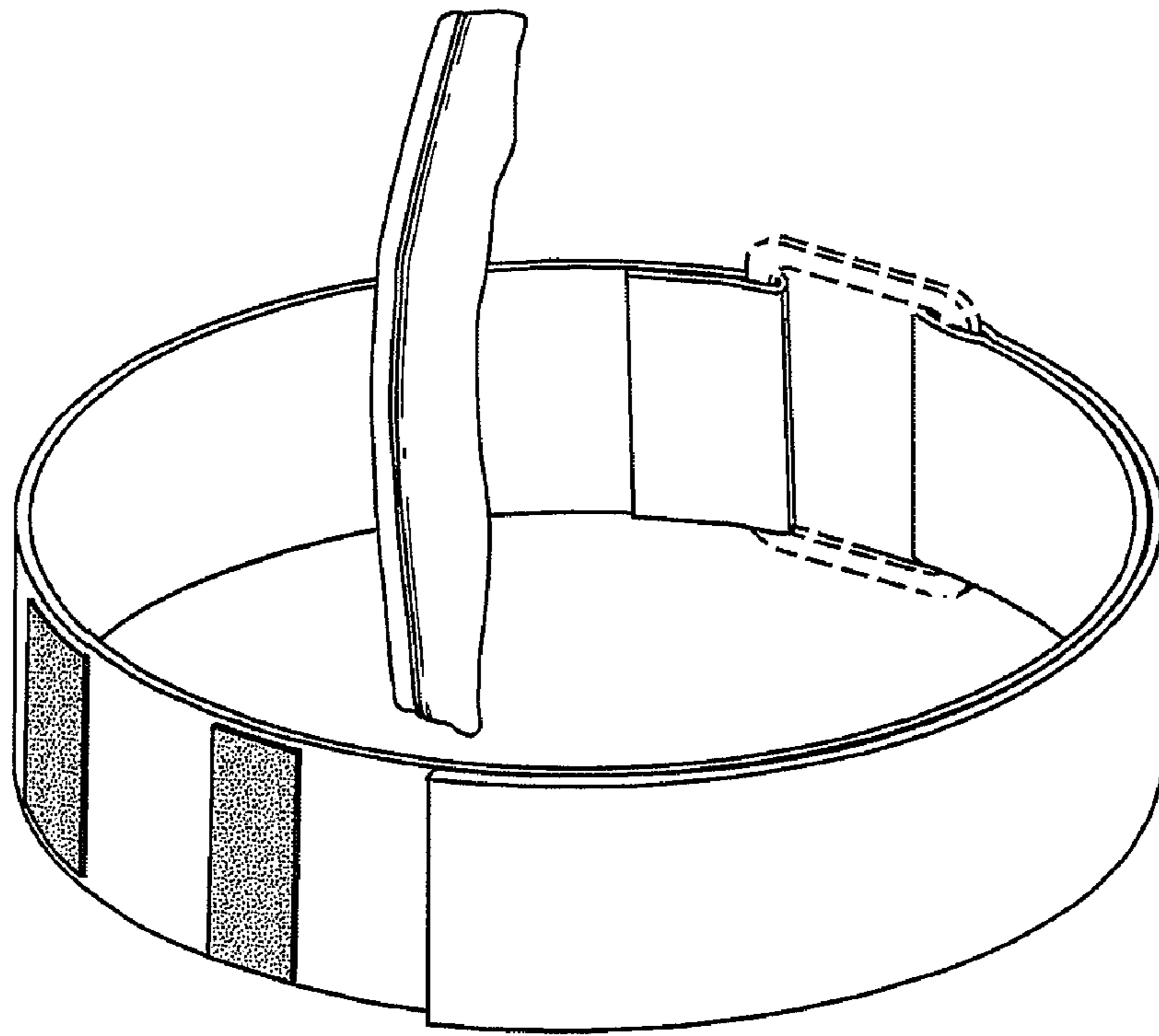

FIG. 2

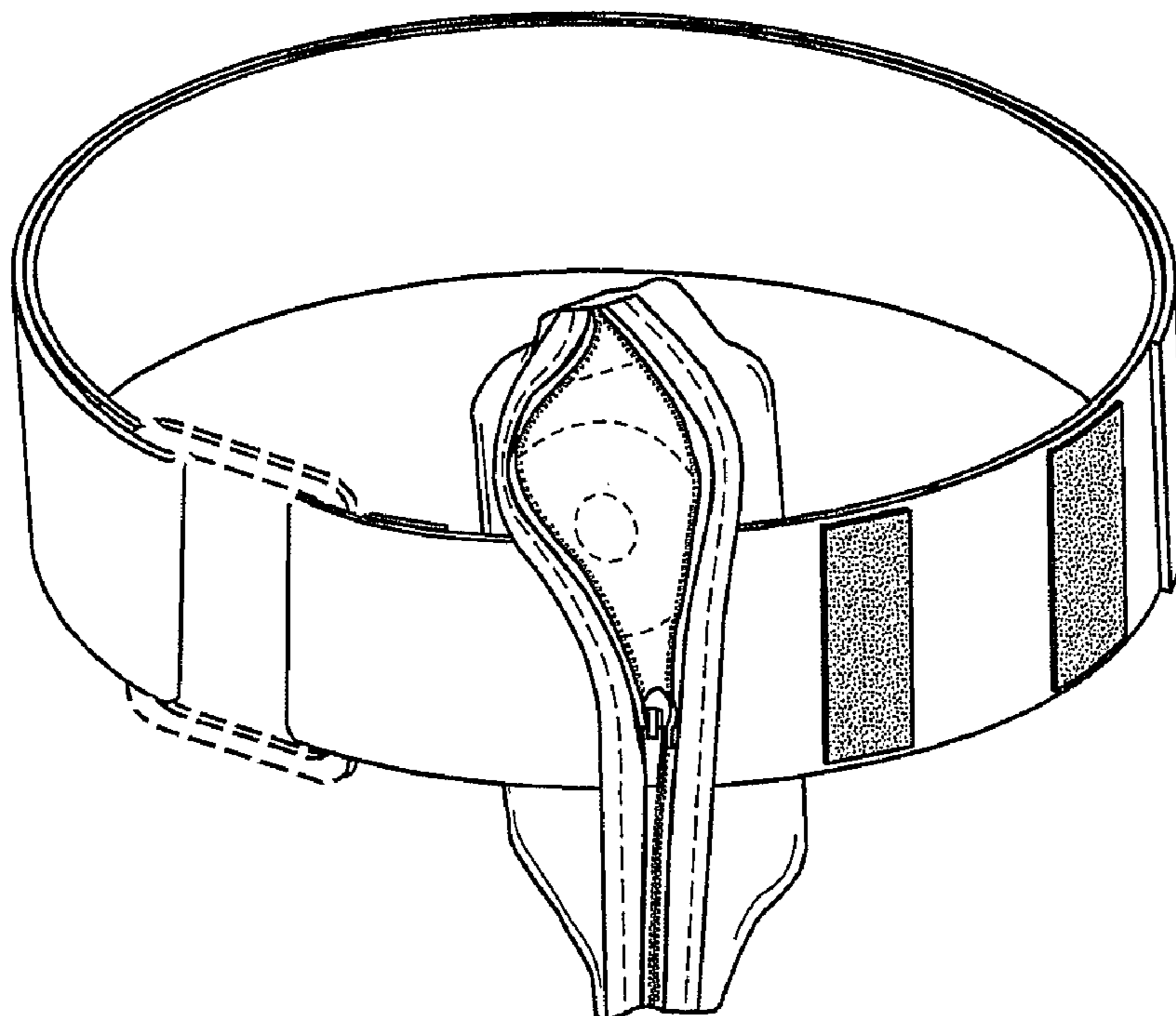

FIG. 3

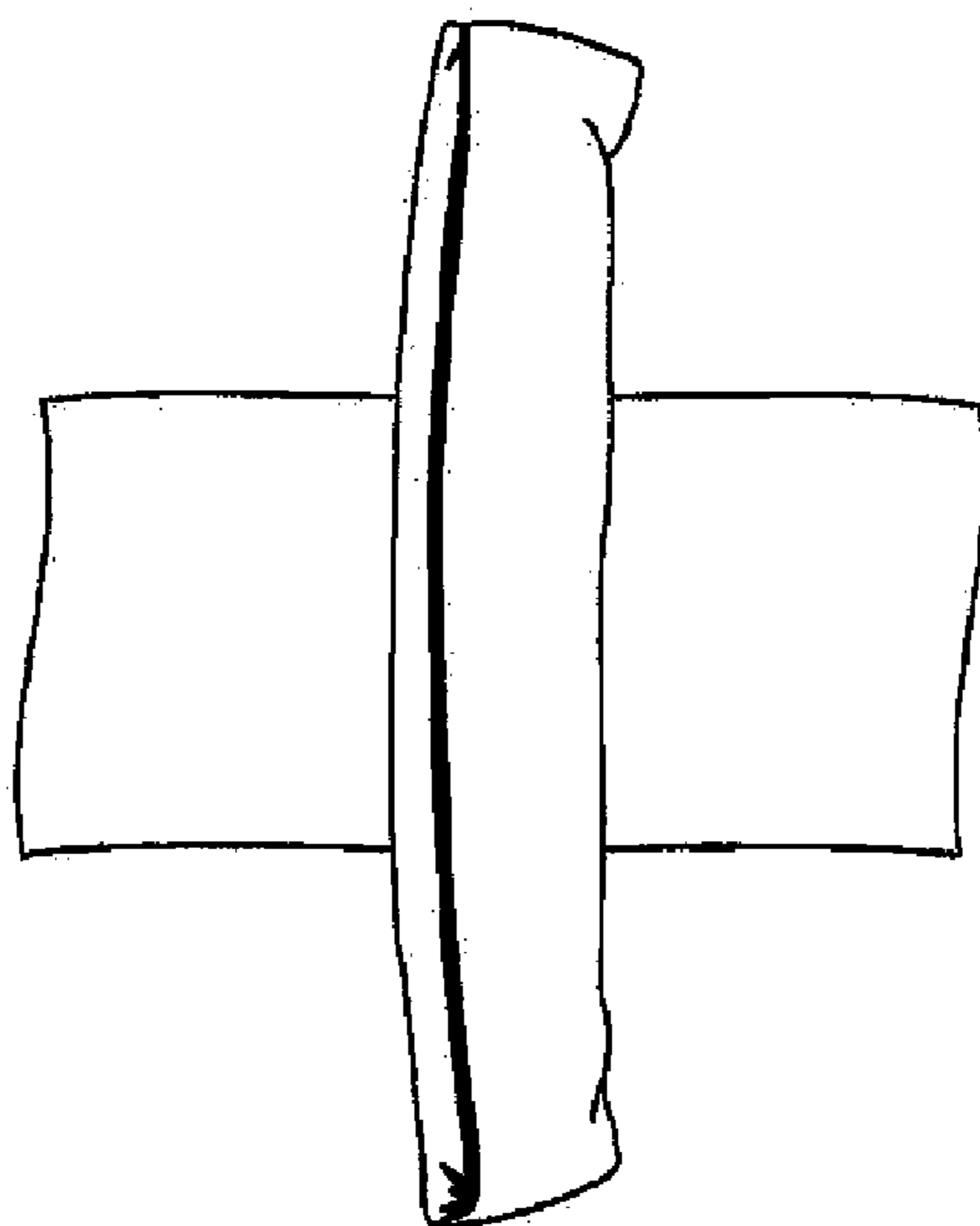

FIG. 4

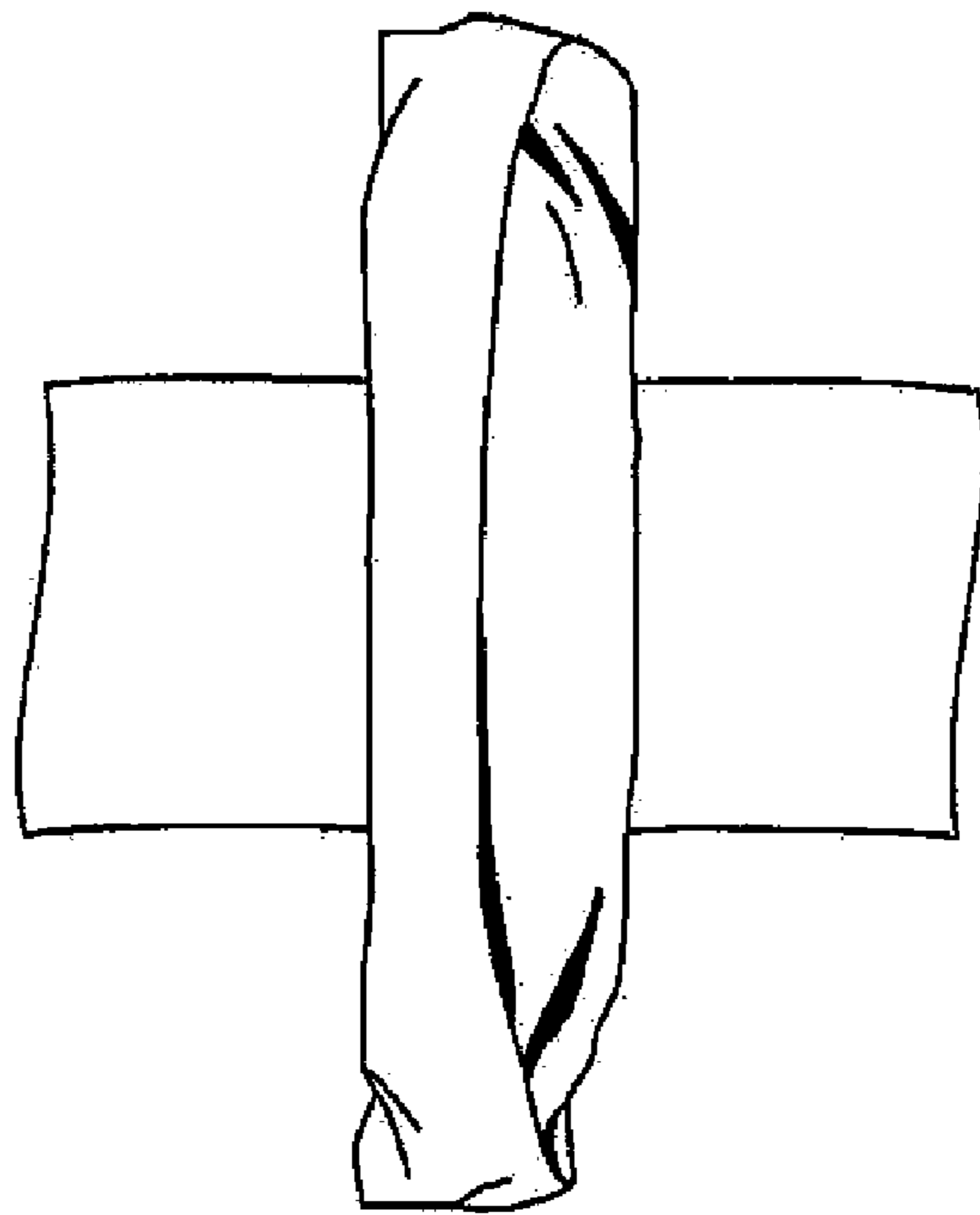

FIG. 5

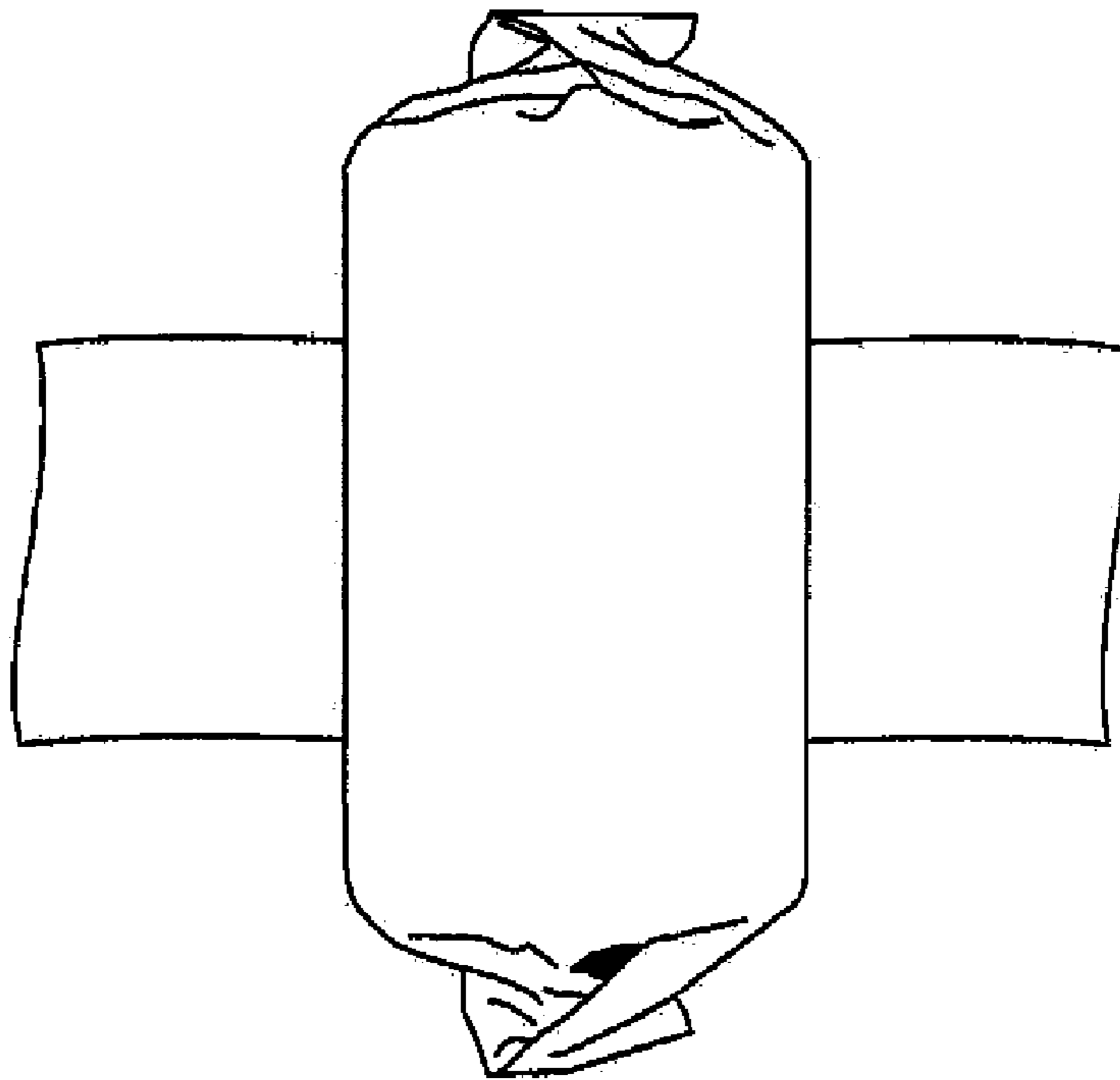

FIG. 6

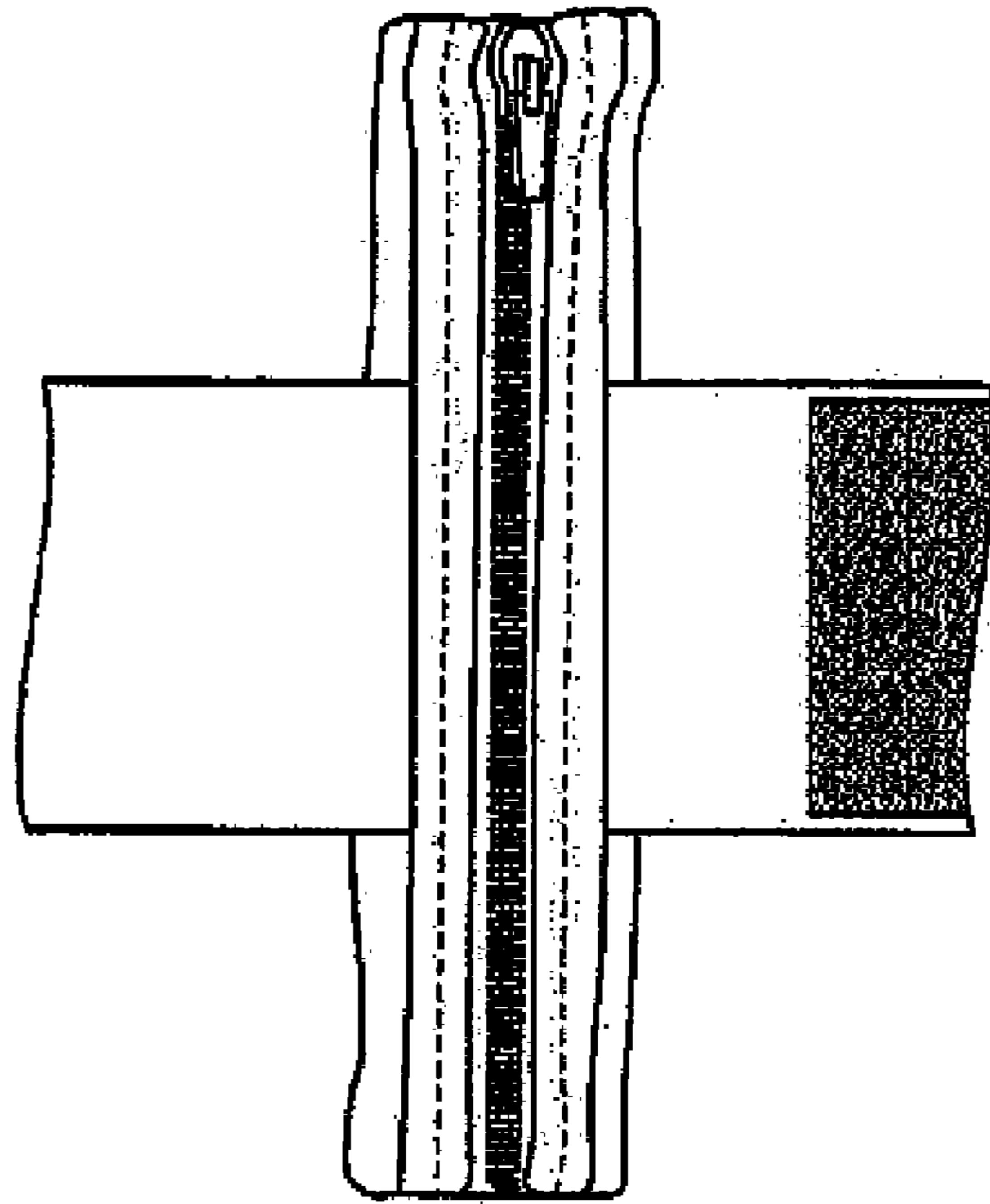

FIG. 7

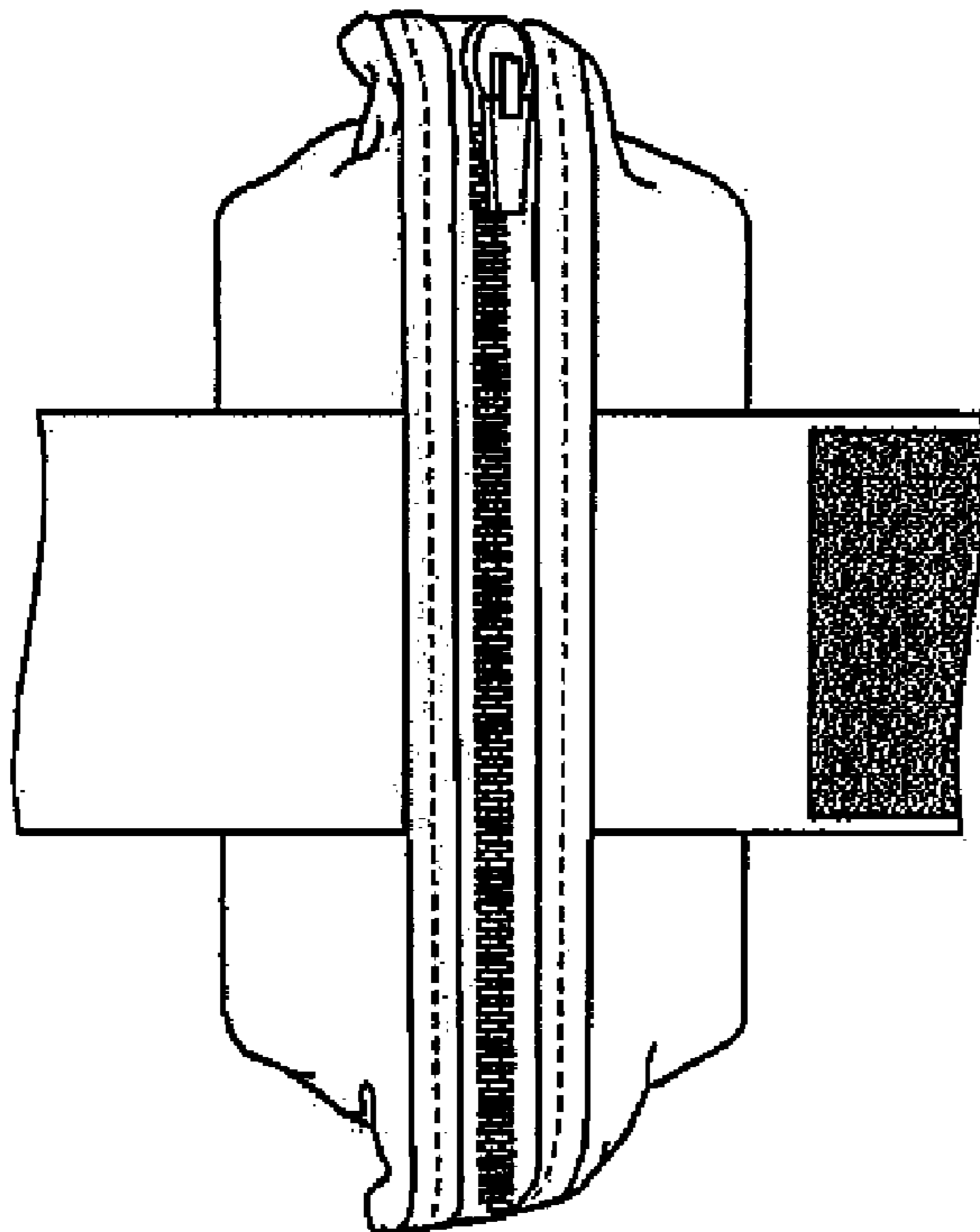

FIG. 8

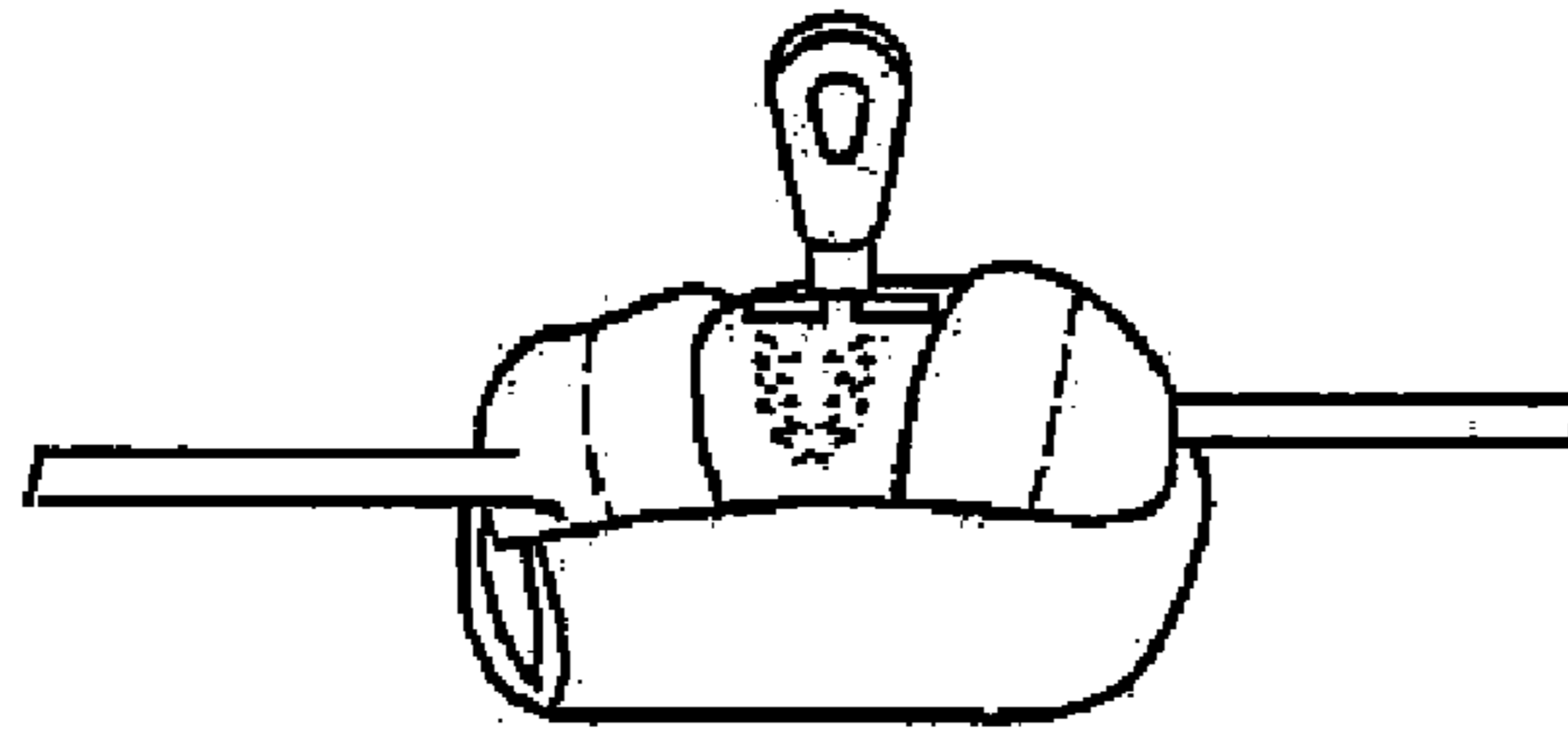

FIG. 9

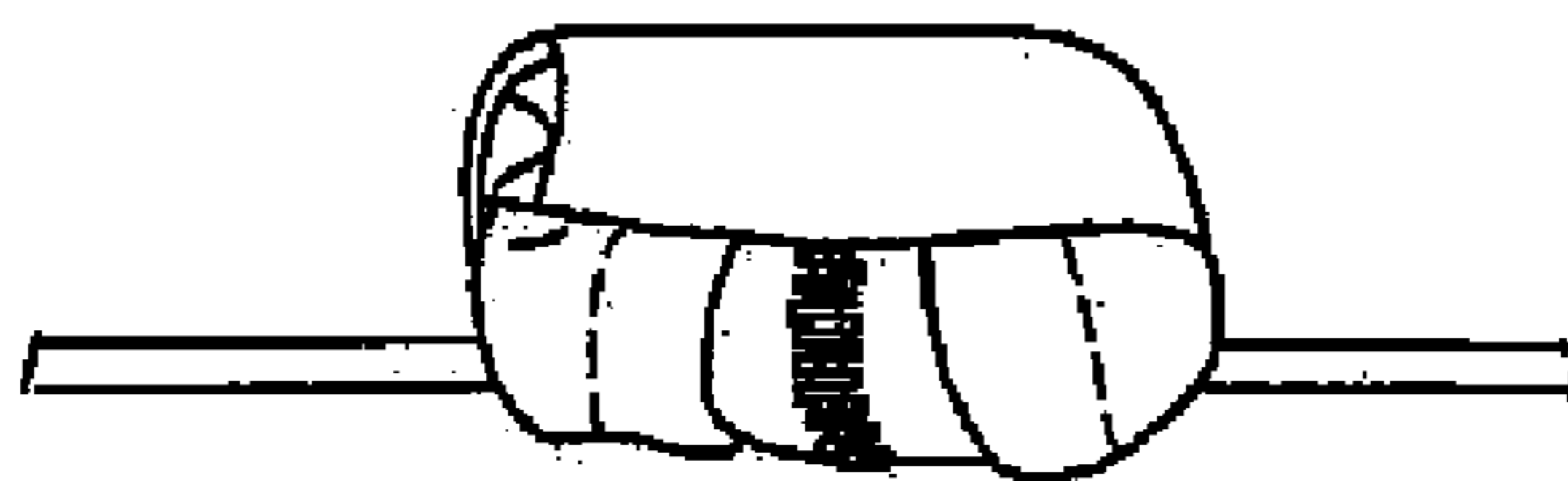

FIG. 10

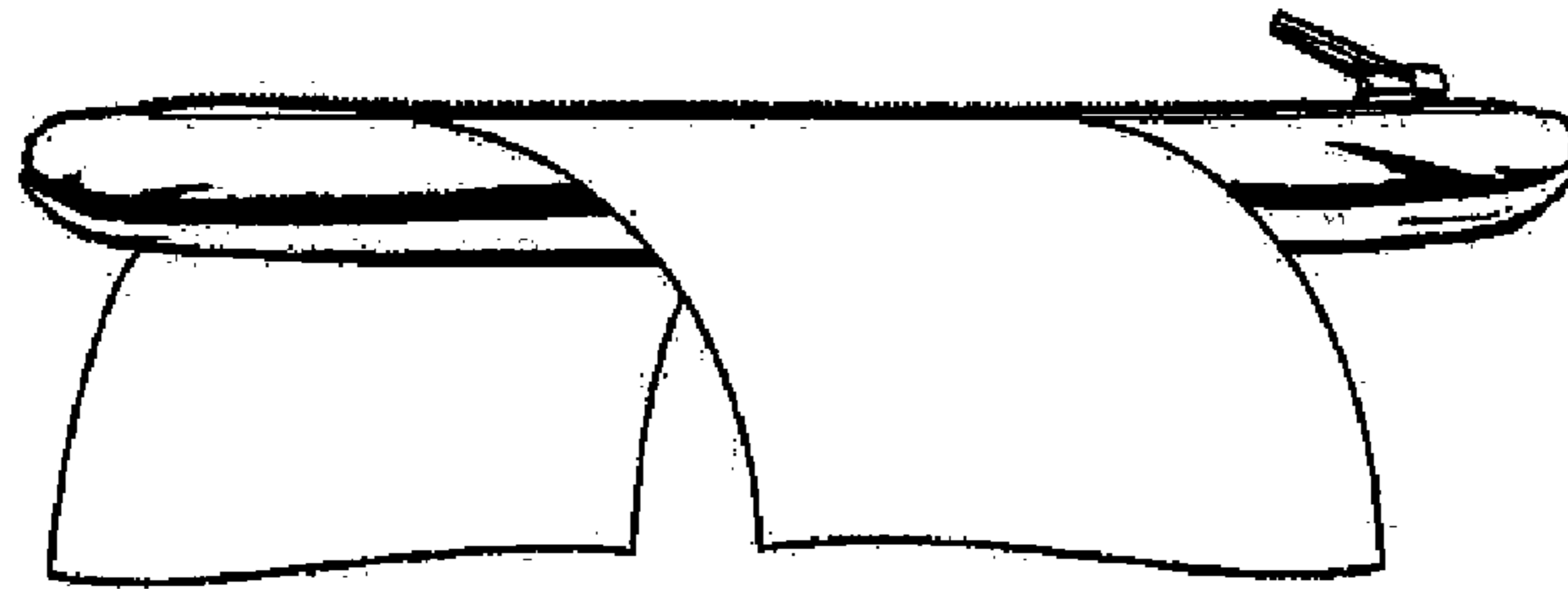

FIG. 11

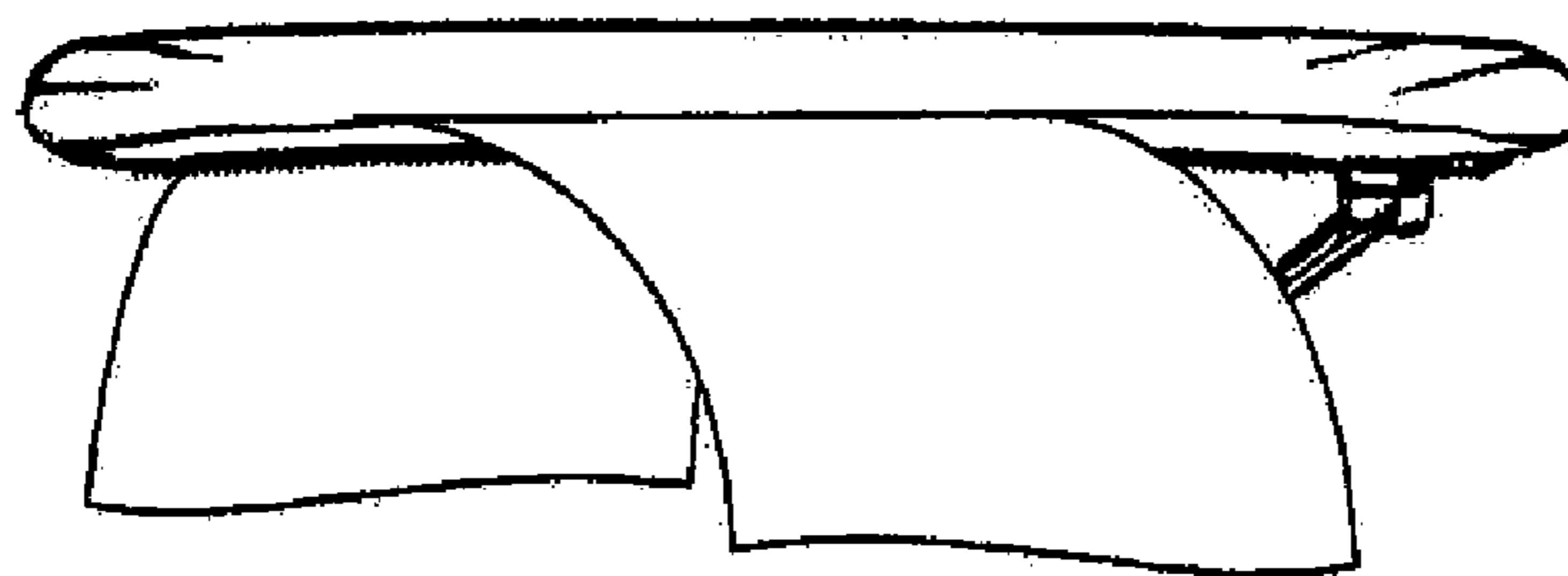

FIG. 12