



US00D612096S

(12) **United States Design Patent**
Enriquez

(10) **Patent No.:** **US D612,096 S**
(45) **Date of Patent:** **** Mar. 16, 2010**

(54) **COSMETIC PRODUCT**

(57) **CLAIM**

(75) Inventor: **Erin Saflor Enriquez**, Camarillo, CA
(US)

What is claimed is the ornamental design for a cosmetic product, as shown and described.

(73) Assignee: **St. Ives Laboratories, Inc.**, Melrose
Park, IL (US)

DESCRIPTION

(**) Term: **14 Years**

FIG. 1 is a perspective view of a cosmetic product, as disposed in a container, showing my new design from the top and front thereof, the dotted lines depicting environmental subject matter only and forming no part of the claimed design;

(21) Appl. No.: **29/339,360**

FIG. 2 is a top plan view of the cosmetic product of FIG. 1; FIG. 3 is a bottom plan view of the cosmetic product of FIG. 1;

(22) Filed: **Jun. 29, 2009**

FIG. 4 is a front elevational view of the cosmetic product of FIG. 1;

(51) **LOC (9) Cl.** **28-03**

(52) **U.S. Cl.** **D28/4**

(58) **Field of Classification Search** D28/4,
D28/8.1, 8.2; D9/500, 503, 504; 510/523,
510/221-224, 147; 424/63, 401, 489; D1/100-102,
D1/130; 206/581, 823

FIG. 5 is a right side elevational view of the cosmetic product of FIG. 1;

See application file for complete search history.

FIG. 6 is a rear elevational view of the cosmetic product of FIG. 1;

(56) **References Cited**

U.S. PATENT DOCUMENTS

FIG. 7 is a left side elevational view of the cosmetic product of FIG. 1;

3,228,662	A	10/1968	Otken
3,479,429	A	11/1969	Friedlander et al.
3,920,883	A	11/1975	Yamada et al.
4,159,028	A	6/1979	Barker et al.
D316,961	S	5/1991	Hoening
D429,146	S	8/2000	Thibiant et al.
6,213,166	B1	4/2001	Thibiant et al.

FIG. 8 is a perspective view of a cosmetic product, as disposed in an alternative container, showing my new design from the top and front thereof, the dotted lines depicting environmental subject matter only and forming no part of the claimed design;

FIG. 9 is a top plan view of the cosmetic product of FIG. 8; FIG. 10 is a bottom plan view of the cosmetic product of FIG. 8;

(Continued)

FOREIGN PATENT DOCUMENTS

JP	59225108	12/1984
----	----------	---------

FIG. 11 is a front elevational view of the cosmetic product of FIG. 8;

FIG. 12 is a right side elevational view of the cosmetic product of FIG. 8;

(Continued)

FIG. 13 is a rear elevational view of the cosmetic product of FIG. 8; and,

FIG. 14 is a left side elevational view of the cosmetic product of FIG. 8.

Primary Examiner—Jennifer Rivard

(74) *Attorney, Agent, or Firm*—Leydig, Voit & Mayer, Ltd.

1 Claim, 4 Drawing Sheets

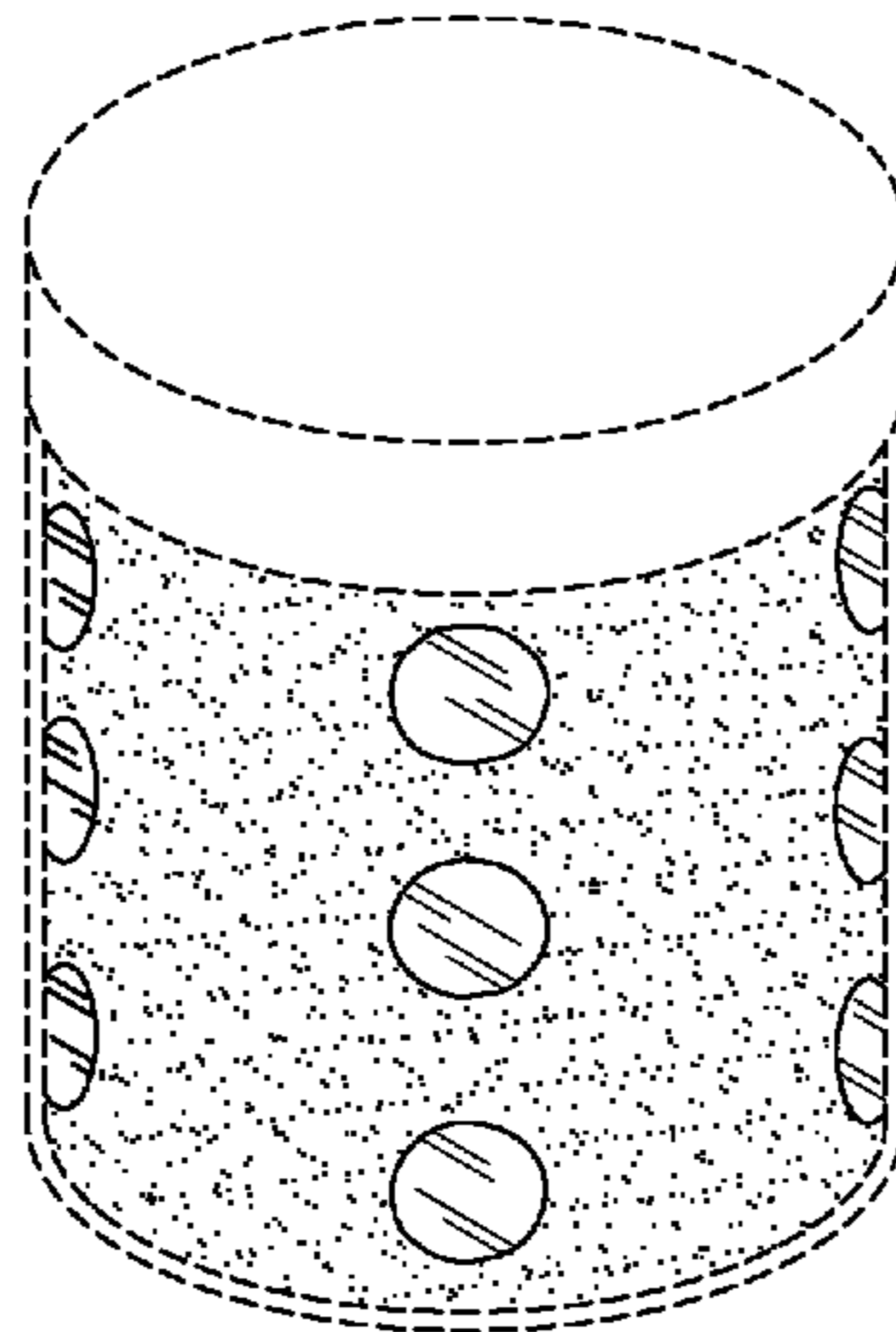

US D612,096 S

Page 2

U.S. PATENT DOCUMENTS

6,245,344 B1	6/2001	Thibiant et al.	
D448,281 S	9/2001	Thibiant et al.	
D451,795 S *	12/2001	Ghatlia et al.	D28/8.1
D452,143 S *	12/2001	Ghatlia et al.	D28/8.1
D452,588 S	12/2001	Look et al.	
D454,984 S	3/2002	Look	
6,367,519 B2	4/2002	Thibiant et al.	
6,403,543 B1	6/2002	George	
6,516,838 B2	2/2003	Thibiant et al.	
D471,666 S	3/2003	Jackel-Marken	
D472,014 S	3/2003	Jackel-Marken	
D472,799 S *	4/2003	Ghatlia et al.	D28/8.1
D478,686 S *	8/2003	Jackel-Marken	D28/4
6,648,026 B2	11/2003	Look et al.	
6,695,510 B1	2/2004	Look et al.	
D494,316 S *	8/2004	Boyd	D28/4
D495,446 S *	8/2004	Jackel-Marken	D28/4
D495,825 S	9/2004	Guay	
D500,886 S	1/2005	Guay	
D500,887 S	1/2005	Guay	
D504,192 S	4/2005	Guay	
D504,193 S	4/2005	Guay	
D504,539 S *	4/2005	Boyd	D28/4
D510,458 S	10/2005	Guay	
6,955,489 B2	10/2005	Look et al.	
D512,201 S	12/2005	Boyd	
D512,202 S	12/2005	Boyd	
D512,548 S	12/2005	Boyd	
D513,109 S	12/2005	Boyd	
D513,825 S	1/2006	Boyd	
D514,743 S	2/2006	Guay	
D515,240 S	2/2006	Guay	
D516,744 S *	3/2006	Jackel-Marken	D28/4
D518,231 S	3/2006	Guay	
D522,175 S *	5/2006	Boyd	D28/4
7,073,965 B2	7/2006	Look et al.	
D537,563 S	2/2007	Taniguchi et al.	
D538,471 S	3/2007	Taniguchi et al.	
D547,491 S	7/2007	Taniguchi	
D555,829 S	11/2007	Faravelli	
7,410,649 B2	8/2008	Yoshimi et al.	
D592,826 S *	5/2009	Lingenhoff	D1/102
2001/0035230 A1	11/2001	Thibiant et al.	
2001/0036467 A1	11/2001	Thibiant et al.	
2001/0044394 A1 *	11/2001	Hagen	510/147
2003/0111130 A1	6/2003	Dugdale et al.	
2003/0171232 A1 *	9/2003	Freeman et al.	510/147
2004/0219119 A1	11/2004	Wei et al.	
2004/0223991 A1	11/2004	Wei et al.	
2004/0228886 A1 *	11/2004	Ding et al.	424/401
2005/0058748 A1 *	3/2005	Bourguignon et al.	426/130
2006/0008438 A1	1/2006	Velarde et al.	
2007/0095721 A1 *	5/2007	Davis et al.	206/581
2007/0167338 A1	7/2007	McHugh et al.	
2008/0196787 A1	8/2008	Comstock et al.	
2009/0074821 A1 *	3/2009	Sakurai et al.	424/401

FOREIGN PATENT DOCUMENTS

WO WO 002100358 A1 12/2002

* cited by examiner

FIG. 2

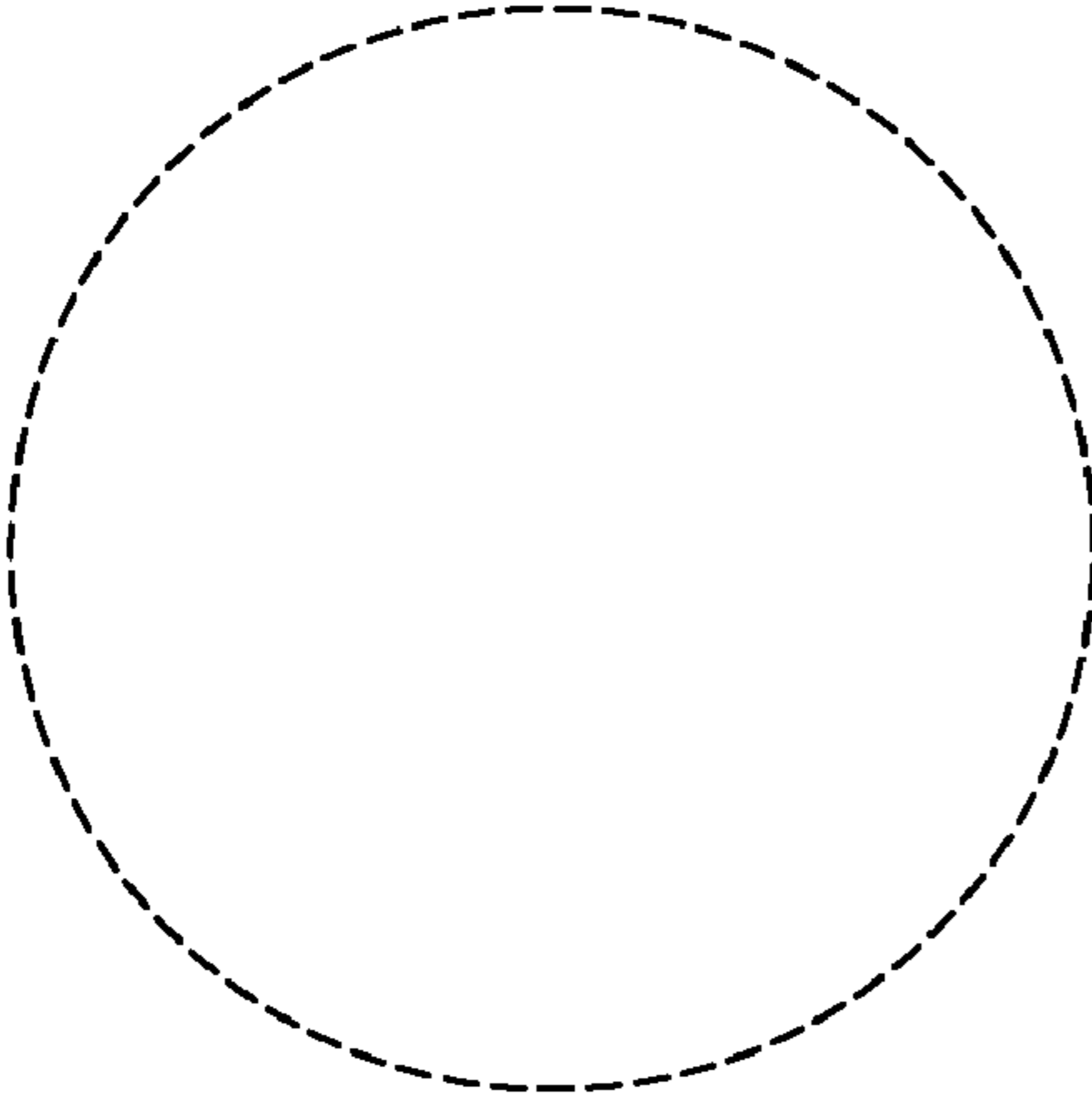

FIG. 3

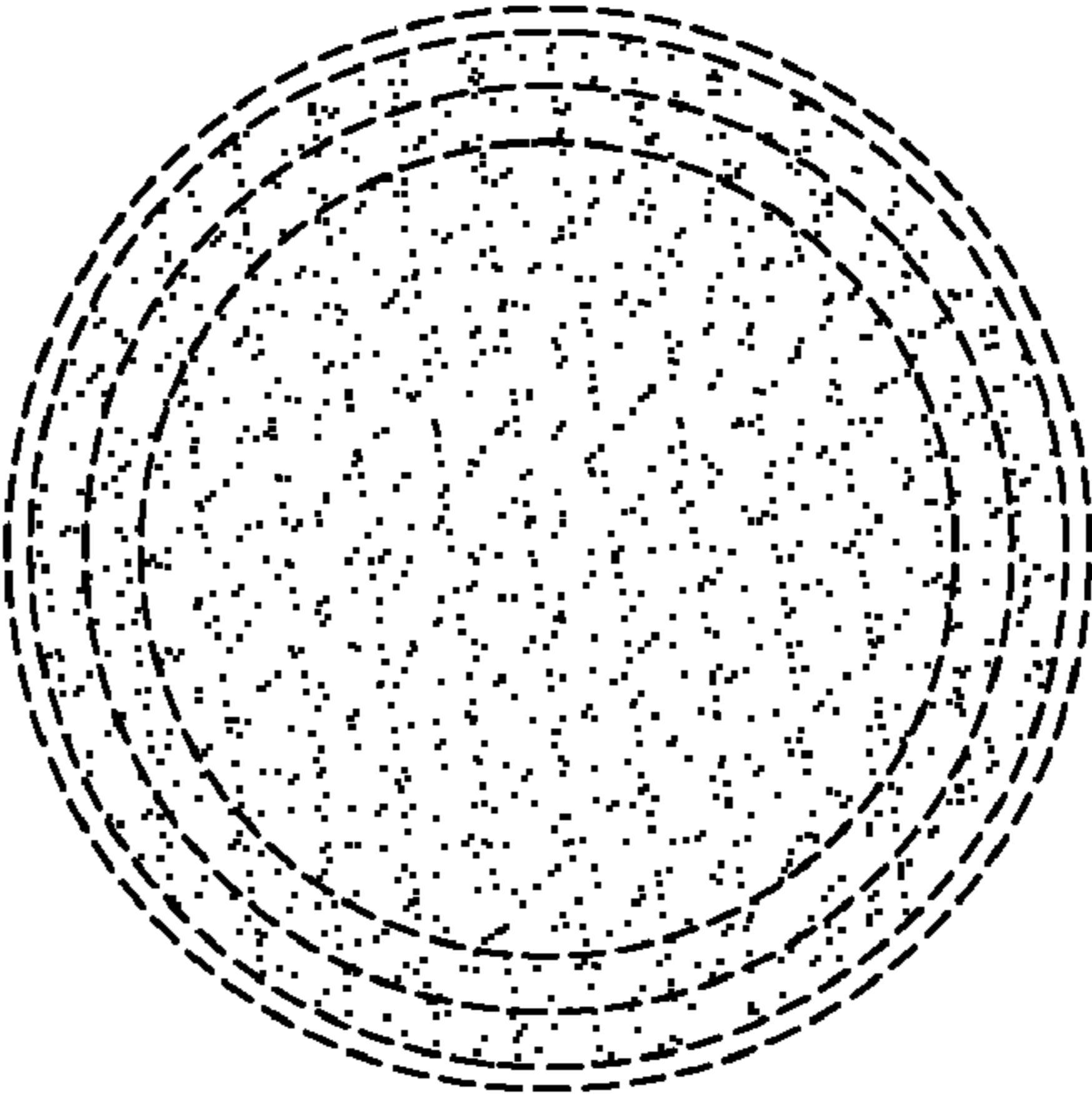

FIG. 1

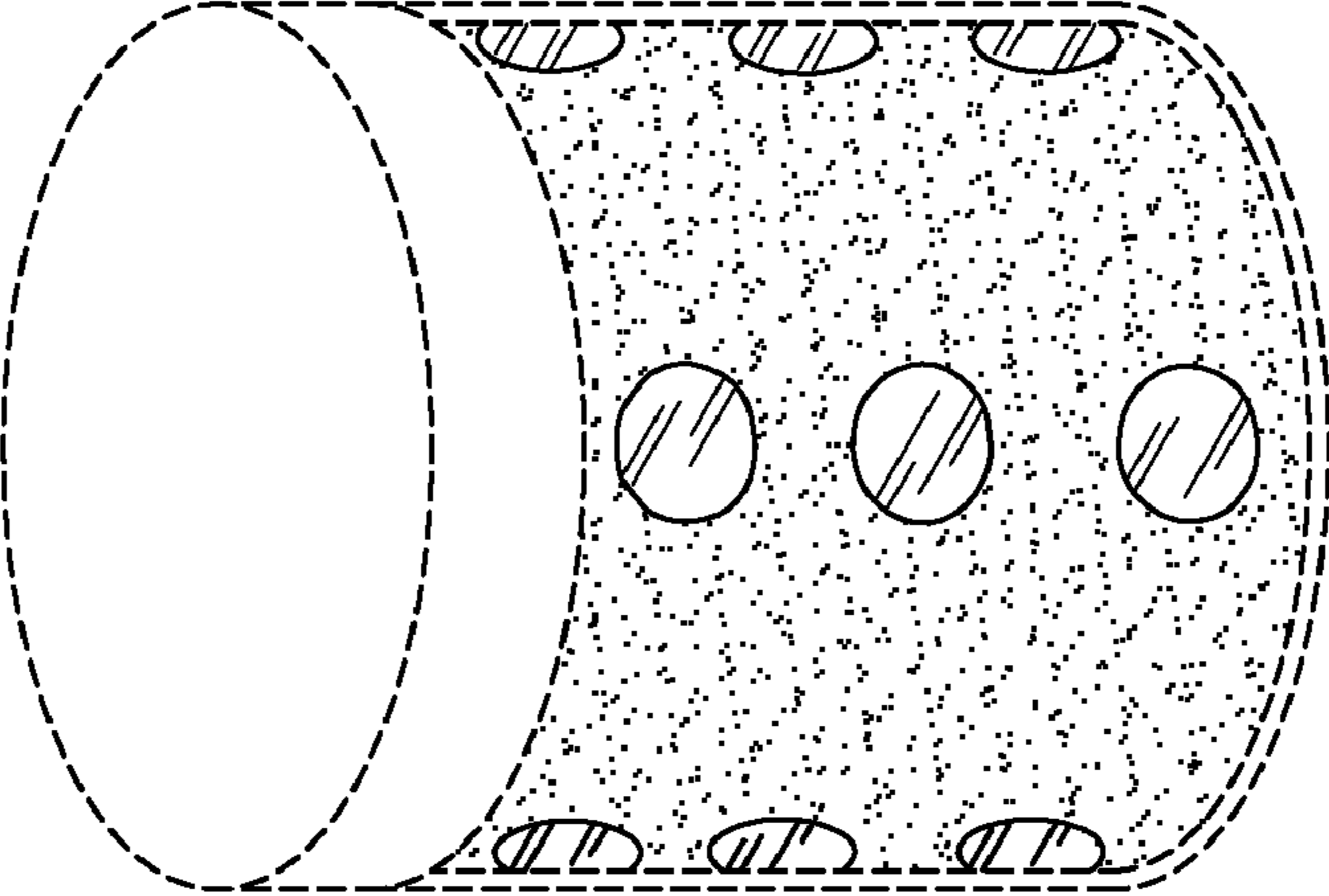

FIG. 7

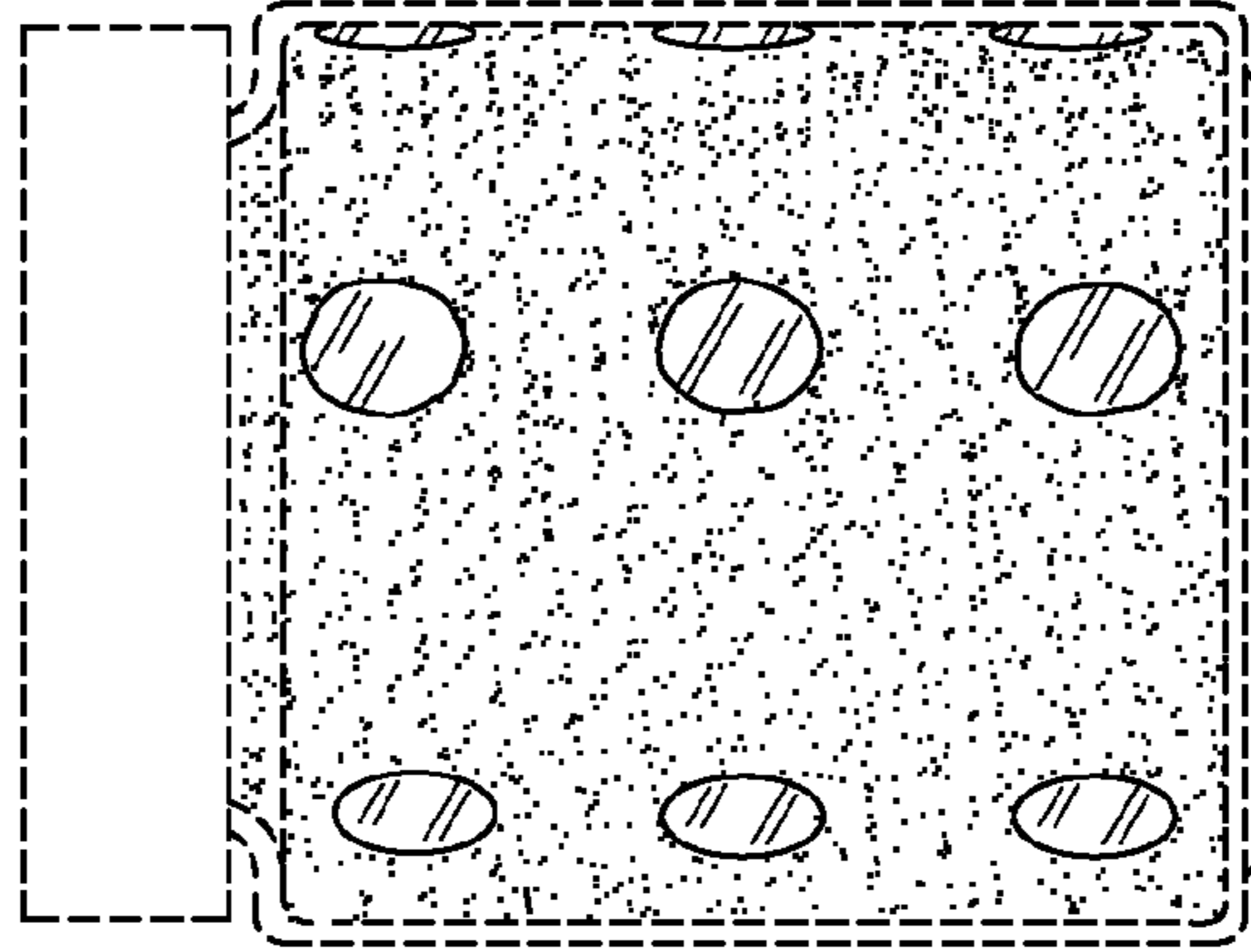

FIG. 6

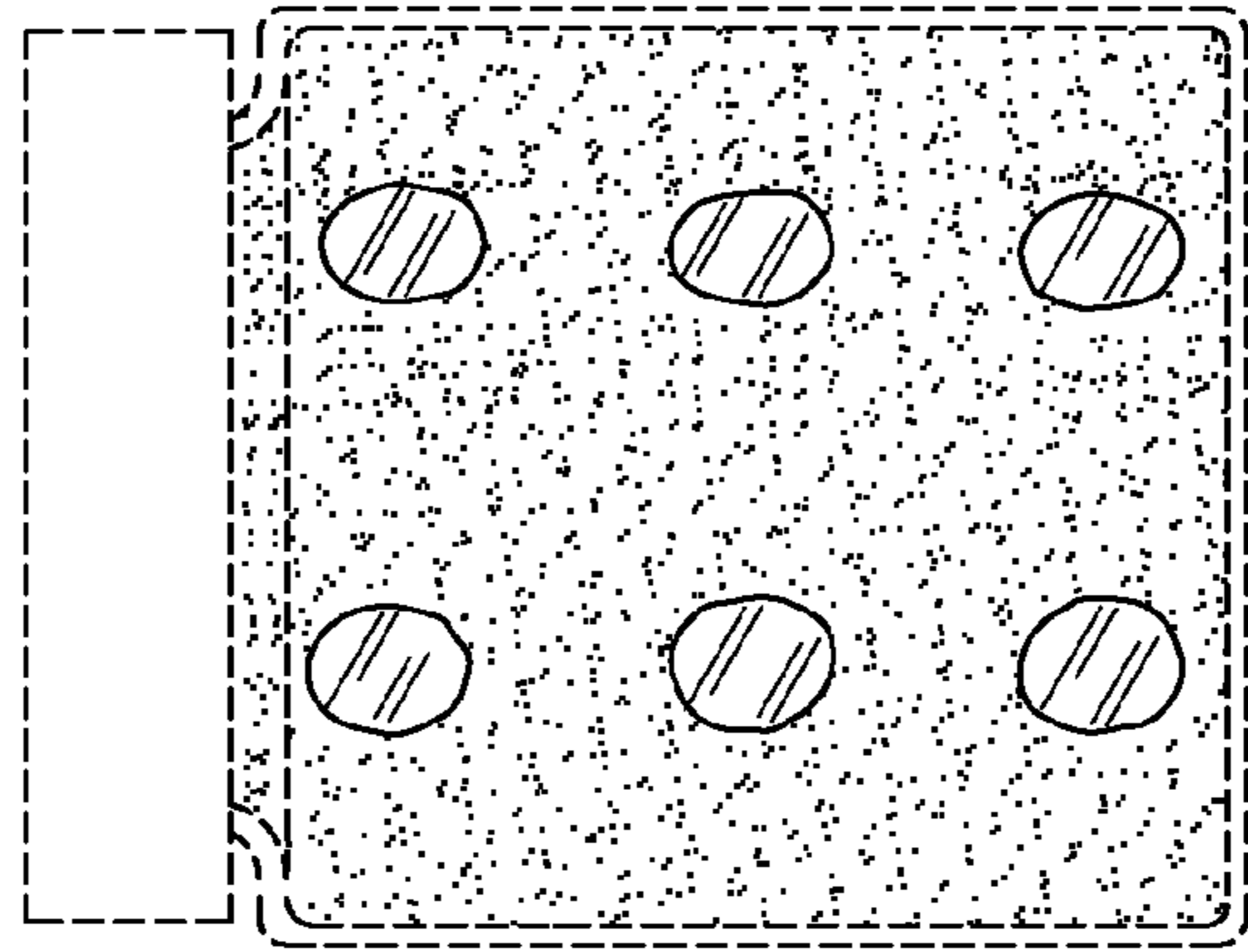

FIG. 5

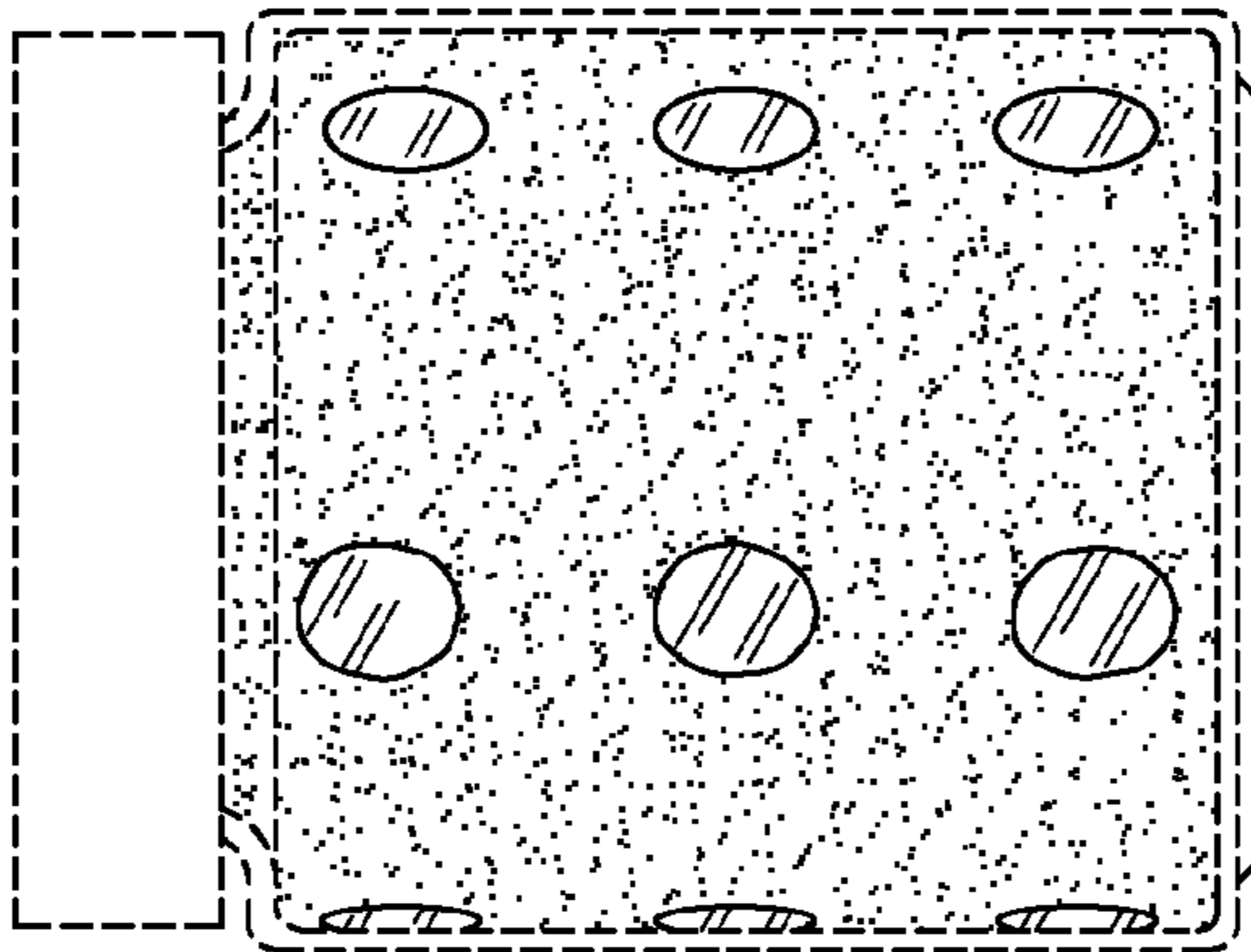

FIG. 4

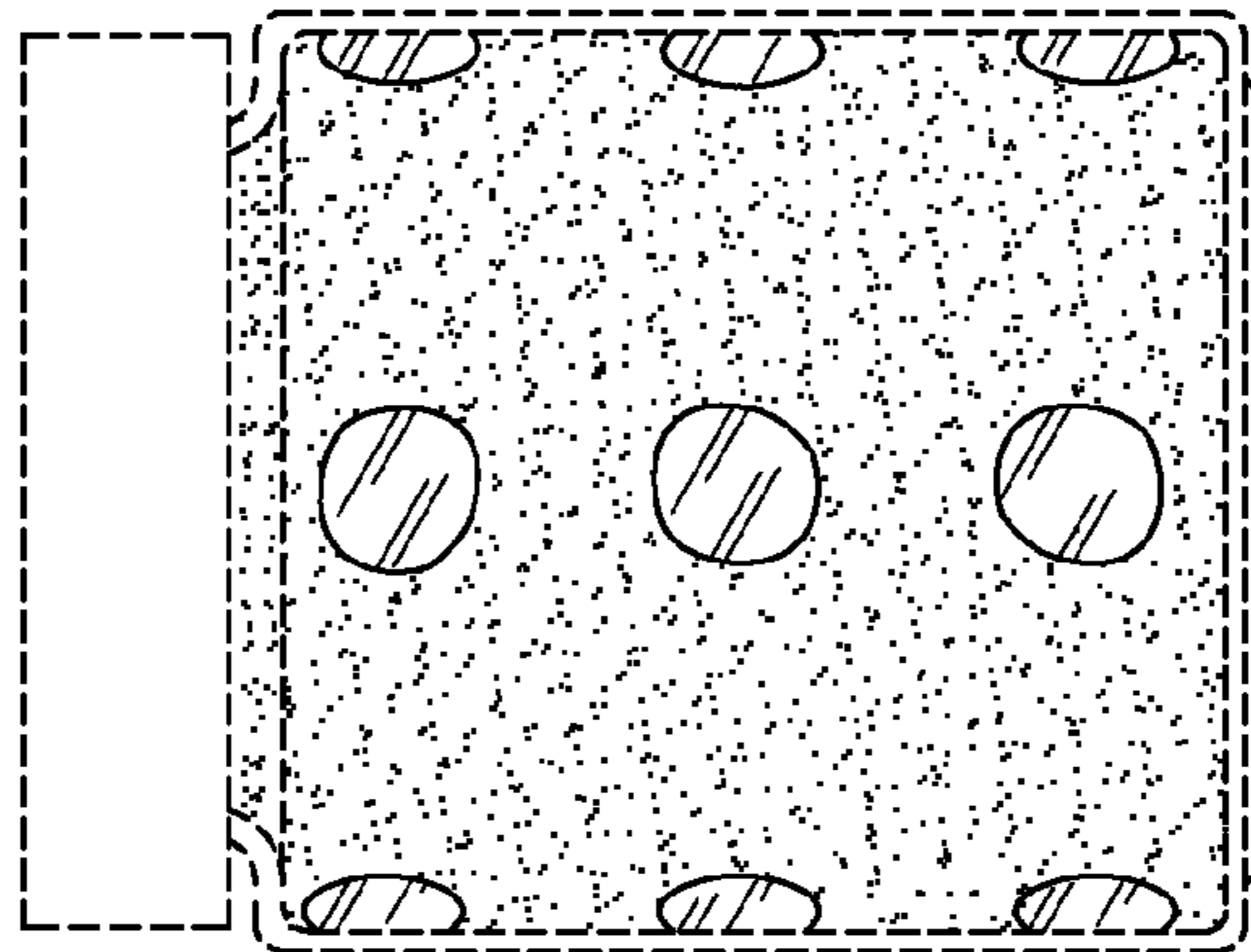

FIG. 9

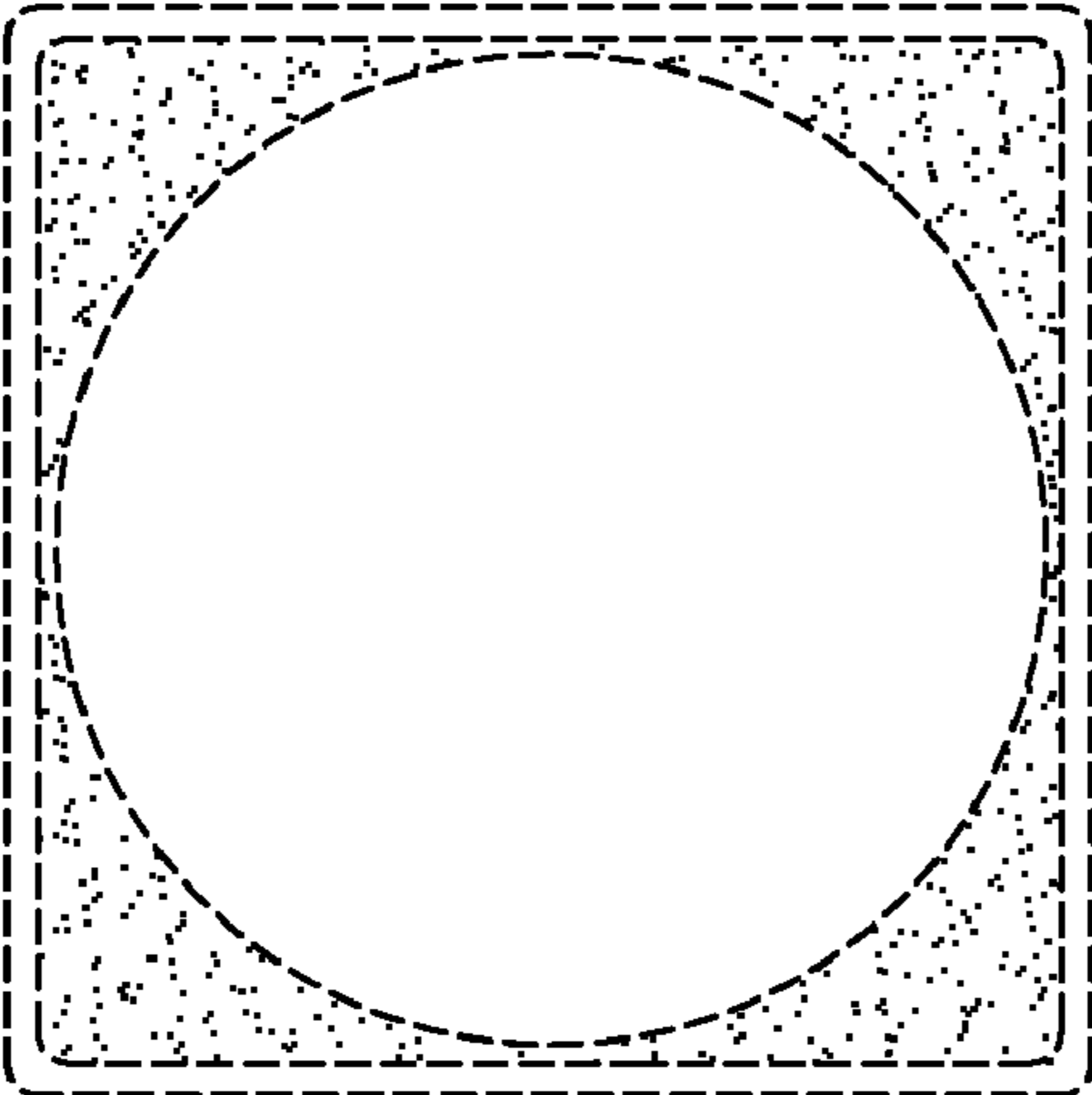

FIG. 10

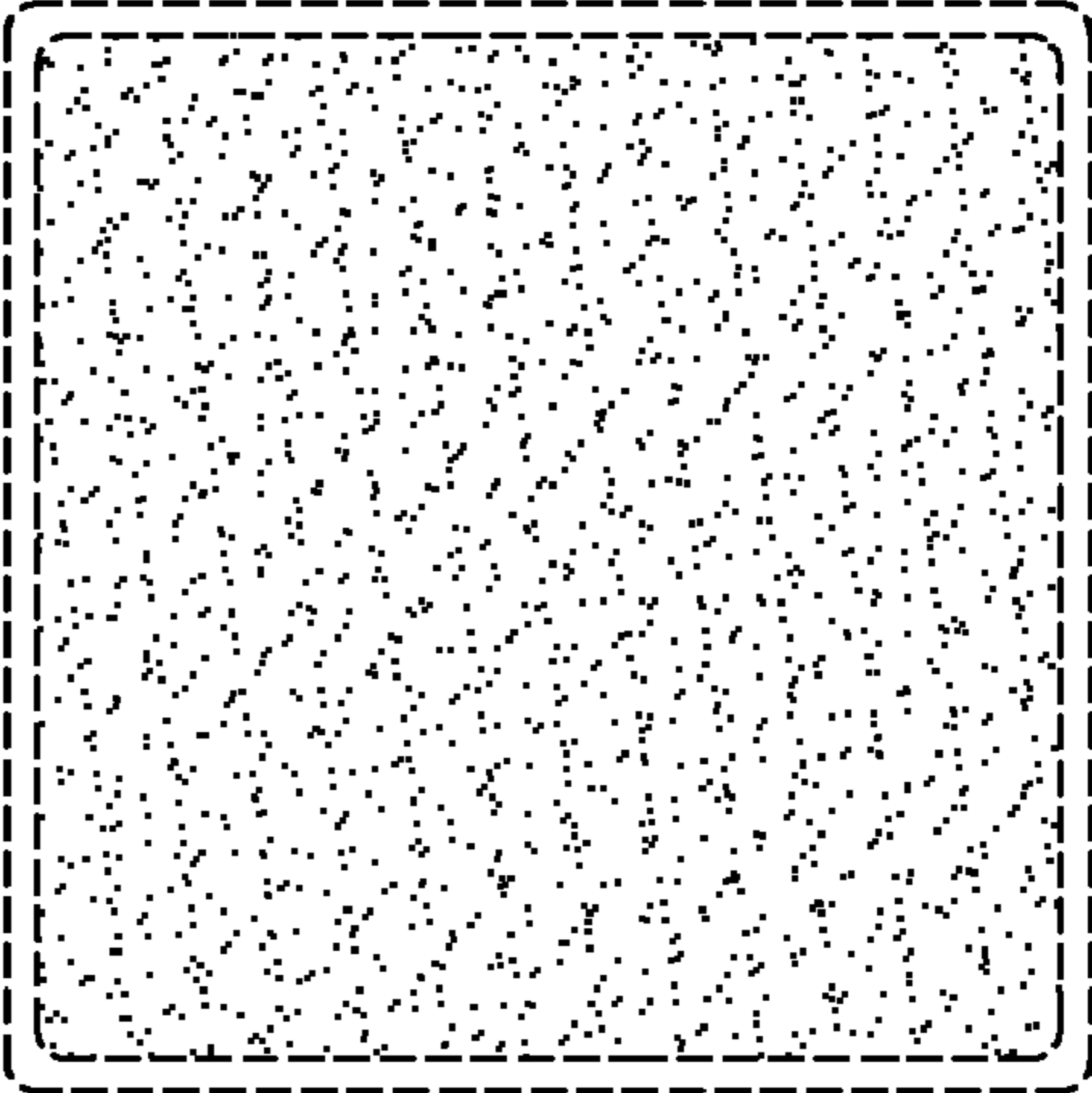

FIG. 8

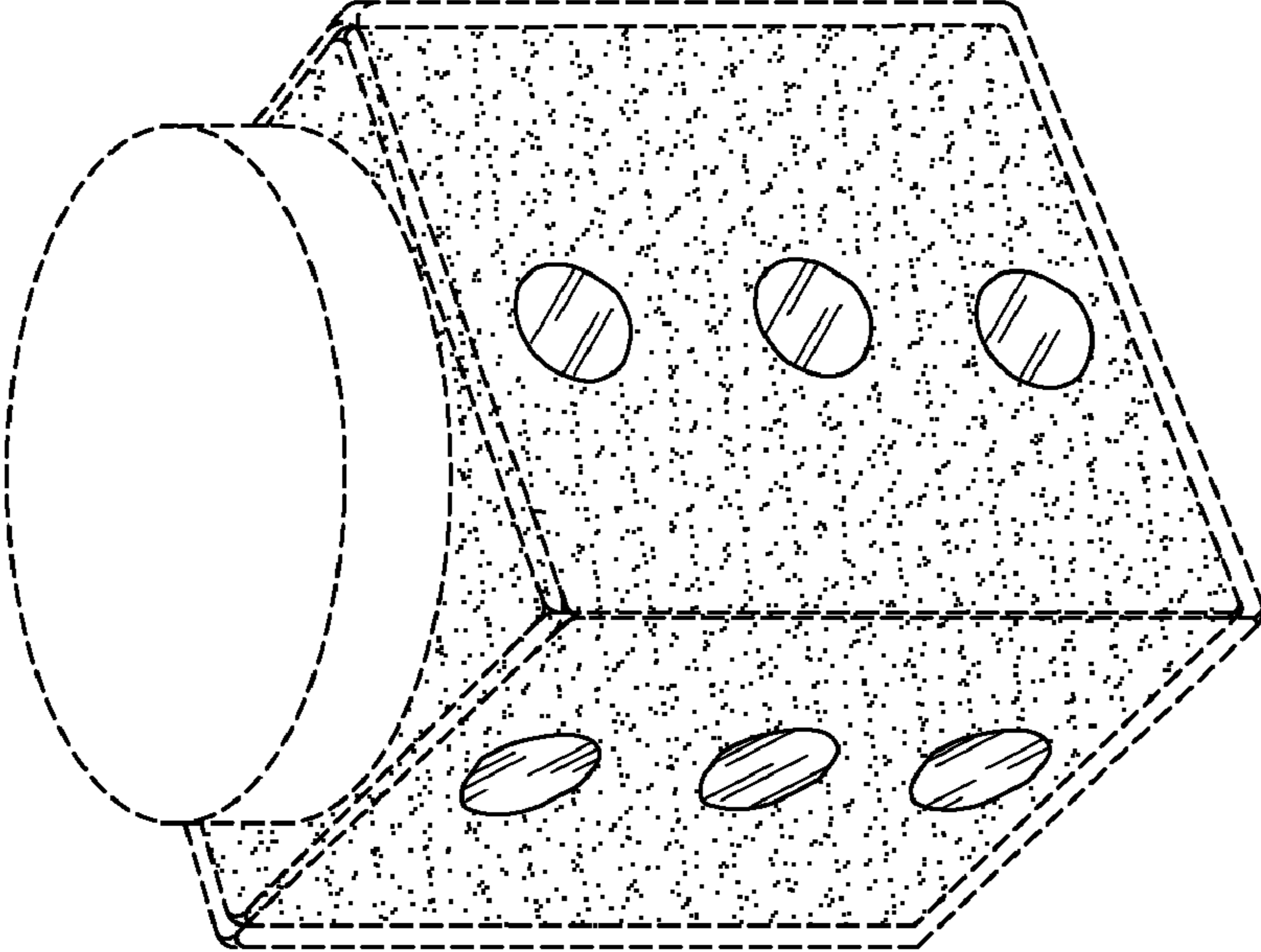

FIG. 14

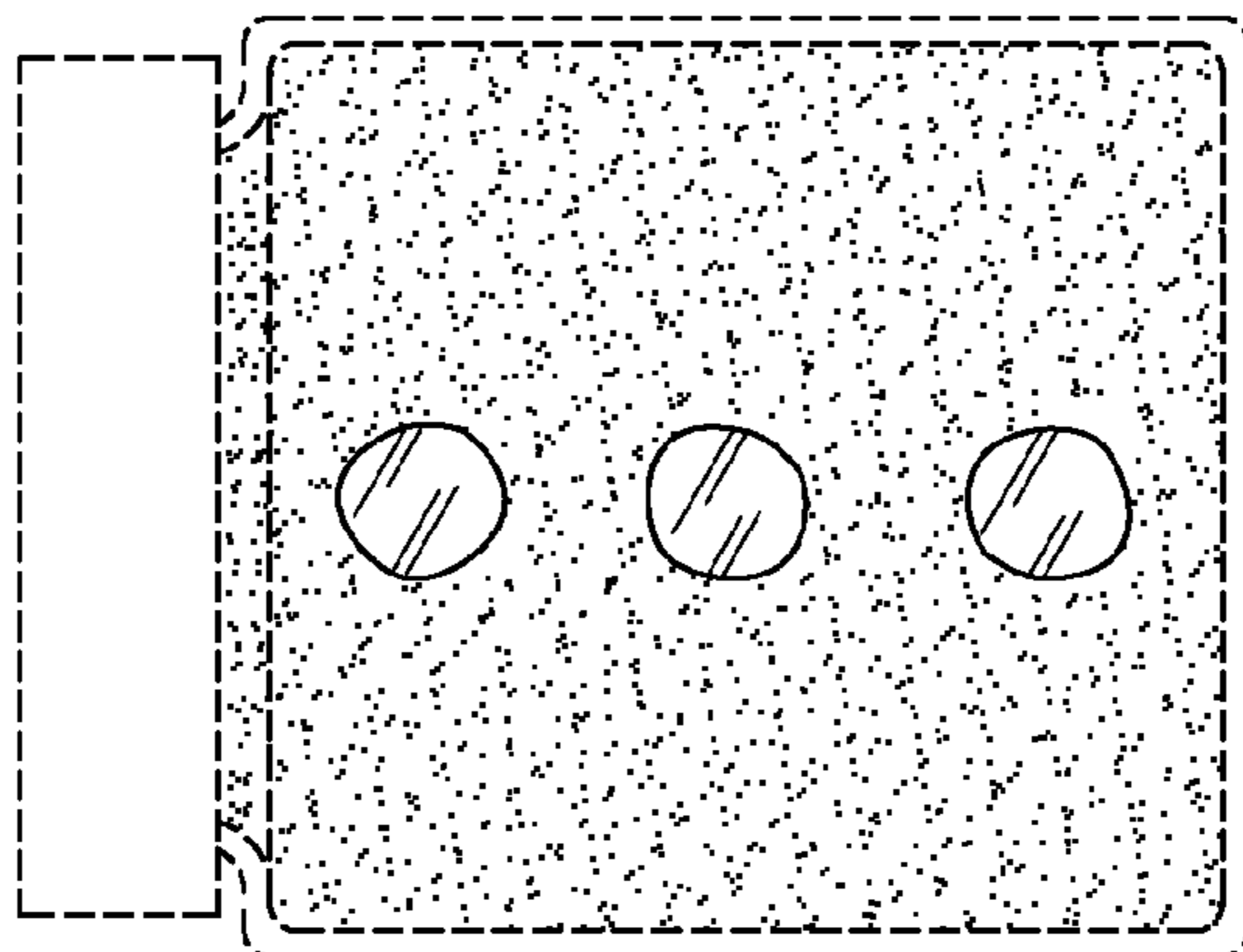

FIG. 13

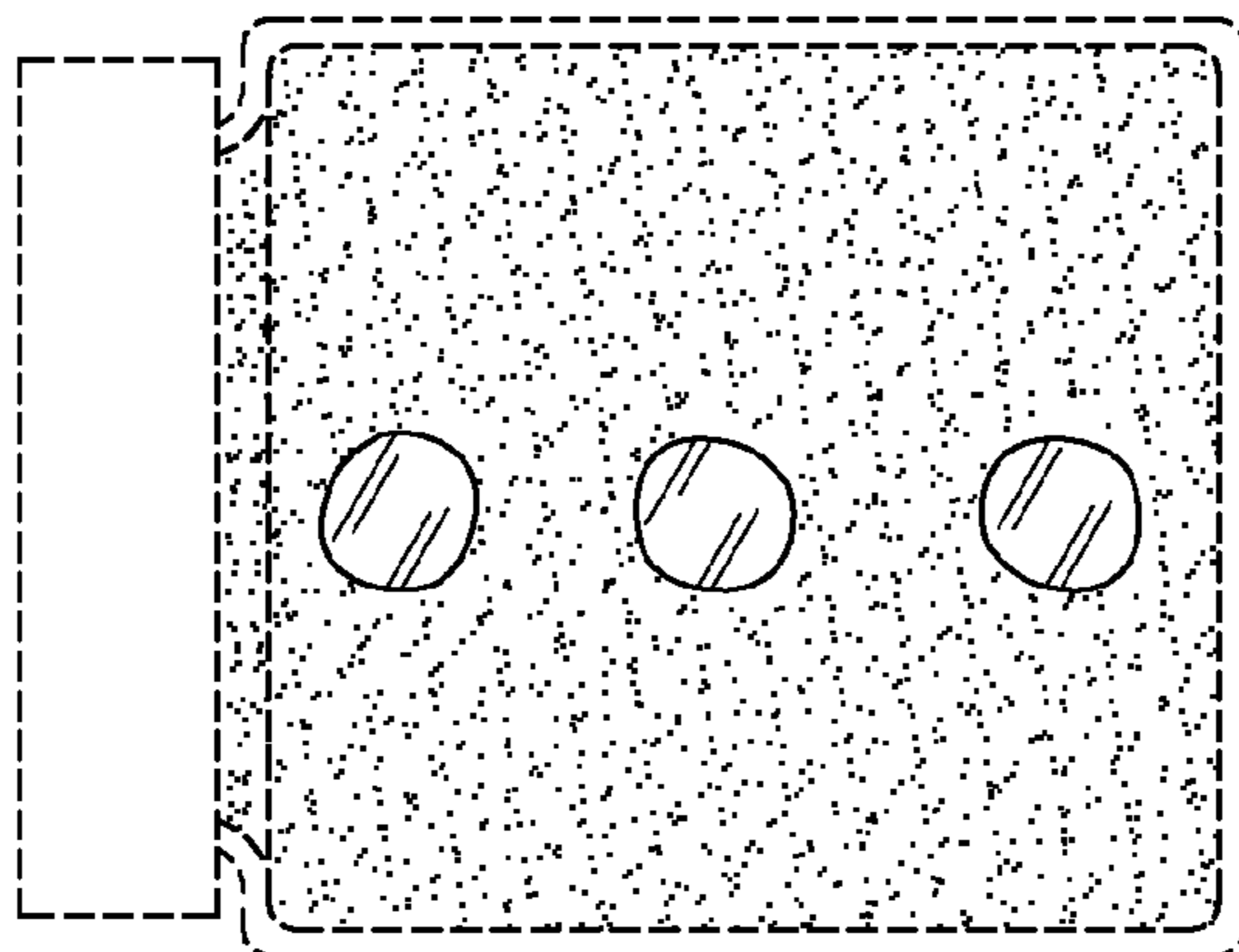

FIG. 12

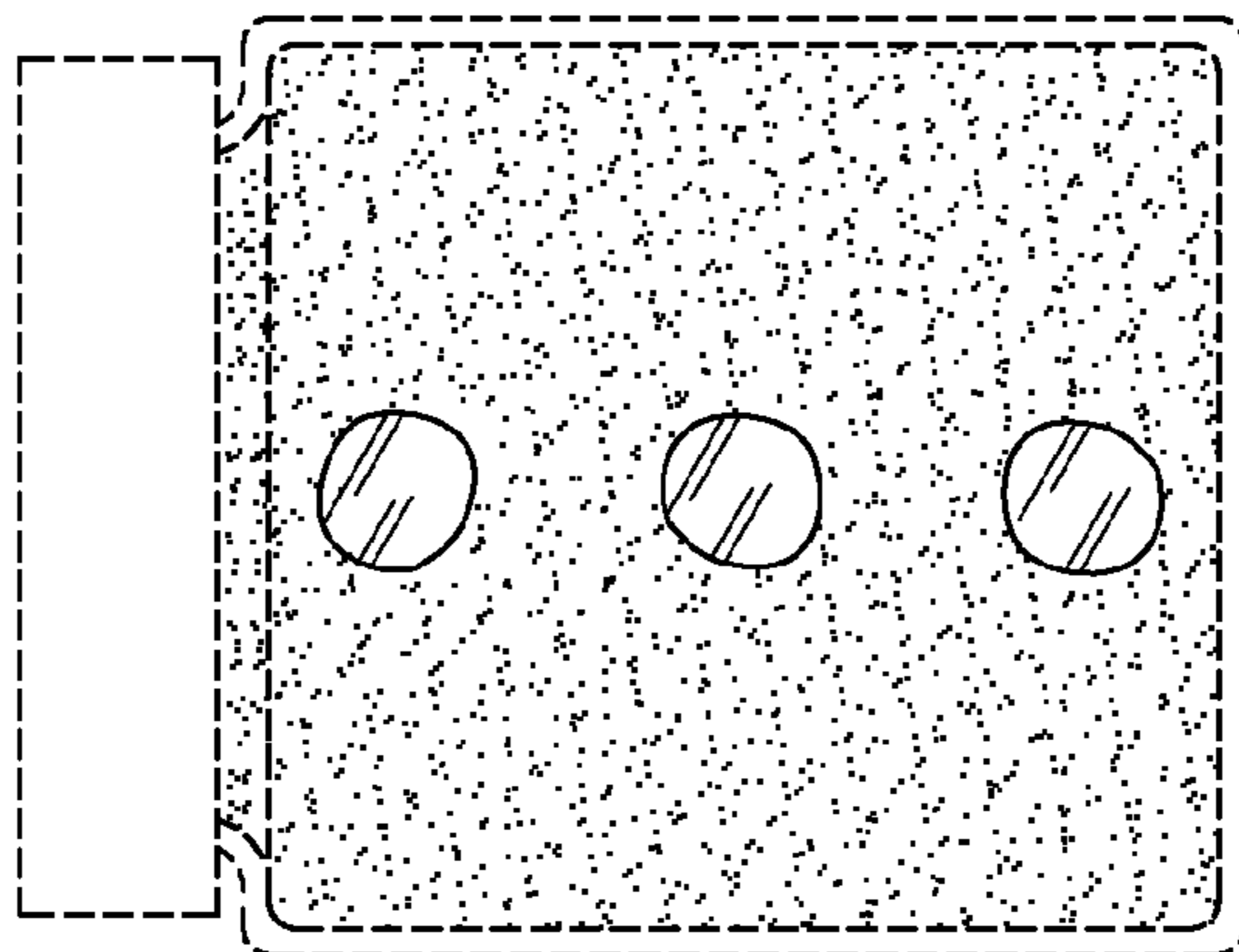

FIG. 11

