



US00D611960S

(12) **United States Design Patent**  
**Hansen et al.**

(10) **Patent No.:** **US D611,960 S**  
(45) **Date of Patent:** **\*\* Mar. 16, 2010**

(54) **HOME AUDIO PLAYER/AMPLIFIER**

(75) Inventors: **Eskild Timme Hansen**, Copenhagen (DK); **Lars Petersen**, Kokkedal (DK); **Nils Toft**, Naerum (DK); **Johan Birger**, Malmoe (SE); **Kalle Jon Nordbo**, Roskilde (DK)

(73) Assignee: **Cisco Technology, Inc.**, San Jose, CA (US)

(\*\*) Term: **14 Years**

(21) Appl. No.: **29/336,391**

(22) Filed: **May 1, 2009**

(51) **LOC (9) Cl.** ..... **14-03**

(52) **U.S. Cl.** ..... **D14/496; D14/203.1**

(58) **Field of Classification Search** ..... D14/496, D14/401, 435, 474, 483, 217, 137, 138, 160, D14/168, 356, 203.1-203.8, 507, 497; 345/156, 345/169, 173-179, 905; 715/727-729, 864; 710/1, 5, 8; 713/1, 600; 455/1.1, 1.7, 73, 455/344-347, 93, 95, 3.01-3.06, 550.1, 573.1; 370/342-344; 369/1, 2, 6-12; 463/43-47; 273/148 B

See application file for complete search history.

(56) **References Cited**

**U.S. PATENT DOCUMENTS**

6,359,987 B1 \* 3/2002 Tran et al. .... 381/58

D469,752 S \* 2/2003 Cuvelier ..... D14/497  
7,052,136 B2 \* 5/2006 Johnson ..... 353/15  
D524,325 S \* 7/2006 Lau et al. .... D14/497  
D571,783 S \* 6/2008 Moldauer et al. .... D14/198  
D579,025 S \* 10/2008 Liu ..... D14/496  
D591,308 S \* 4/2009 Sasaki et al. .... D14/496  
D593,130 S \* 5/2009 Smith ..... D14/496

\* cited by examiner

*Primary Examiner*—Prabhakar Deshmukh

(74) *Attorney, Agent, or Firm*—Haynes and Boone, LLP.

(57) **CLAIM**

The ornamental design for a home audio player/amplifier, as shown and described.

**DESCRIPTION**

FIG. 1 is a front view showing our new home audio player/amplifier;

FIG. 2 is a side view thereof;

FIG. 3 is another side view thereof;

FIG. 4 is a back view thereof;

FIG. 5 is a top view thereof;

FIG. 6 is a bottom view thereof; and,

FIG. 7 is a perspective view thereof.

The areas in broken lines are for illustrative purposes only and form no part of the claimed design.

**1 Claim, 7 Drawing Sheets**

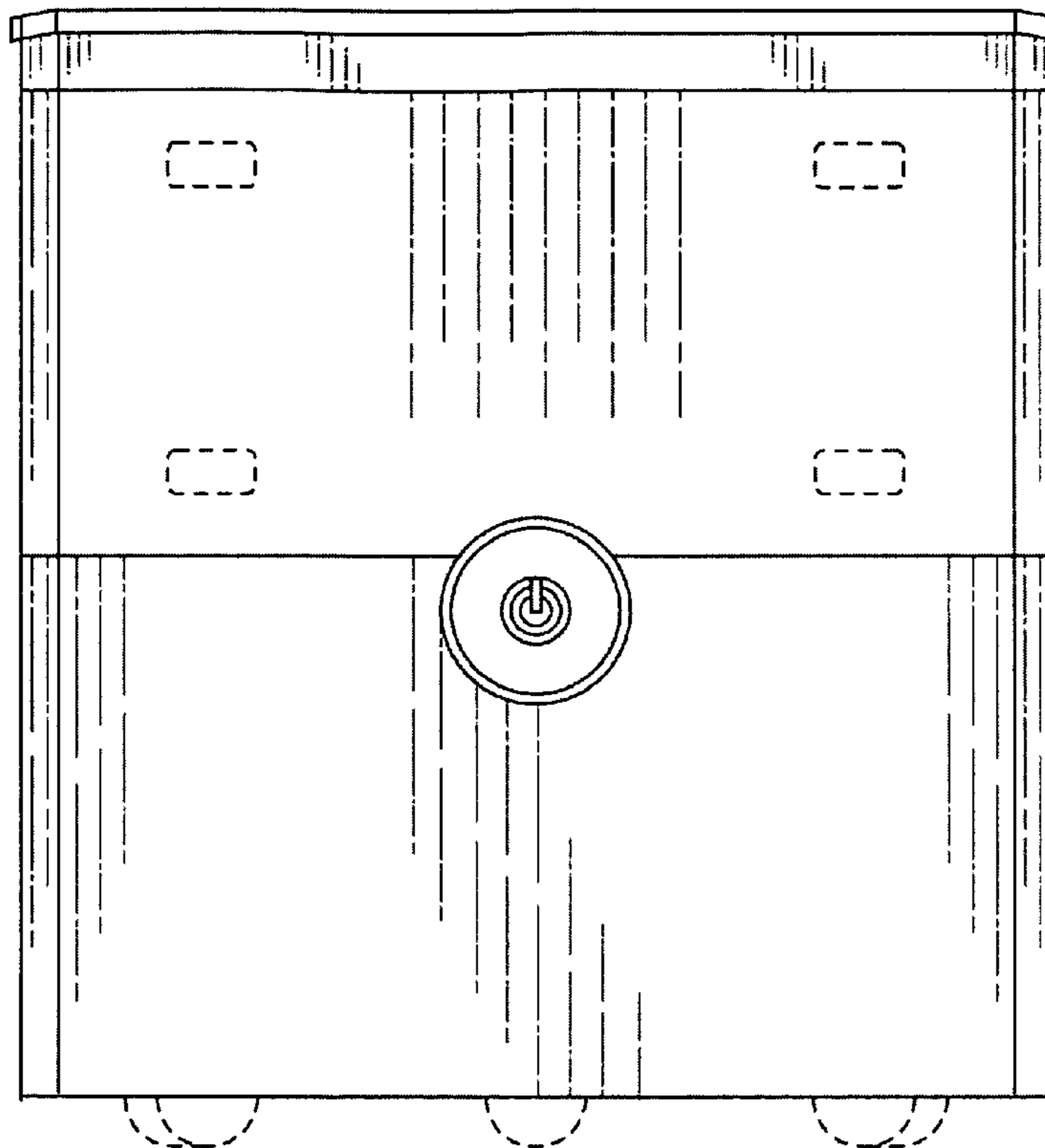

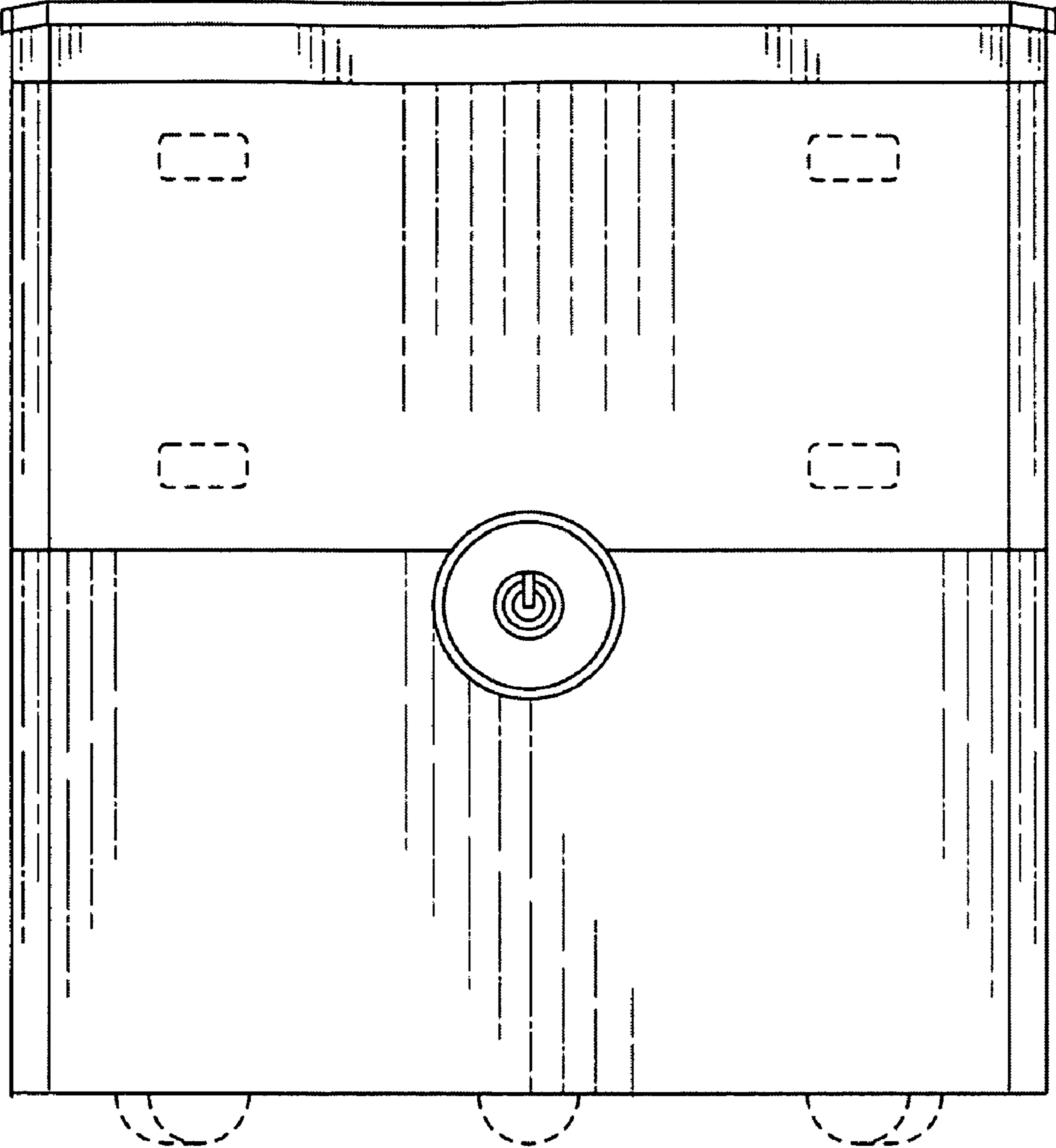

FIG. 1

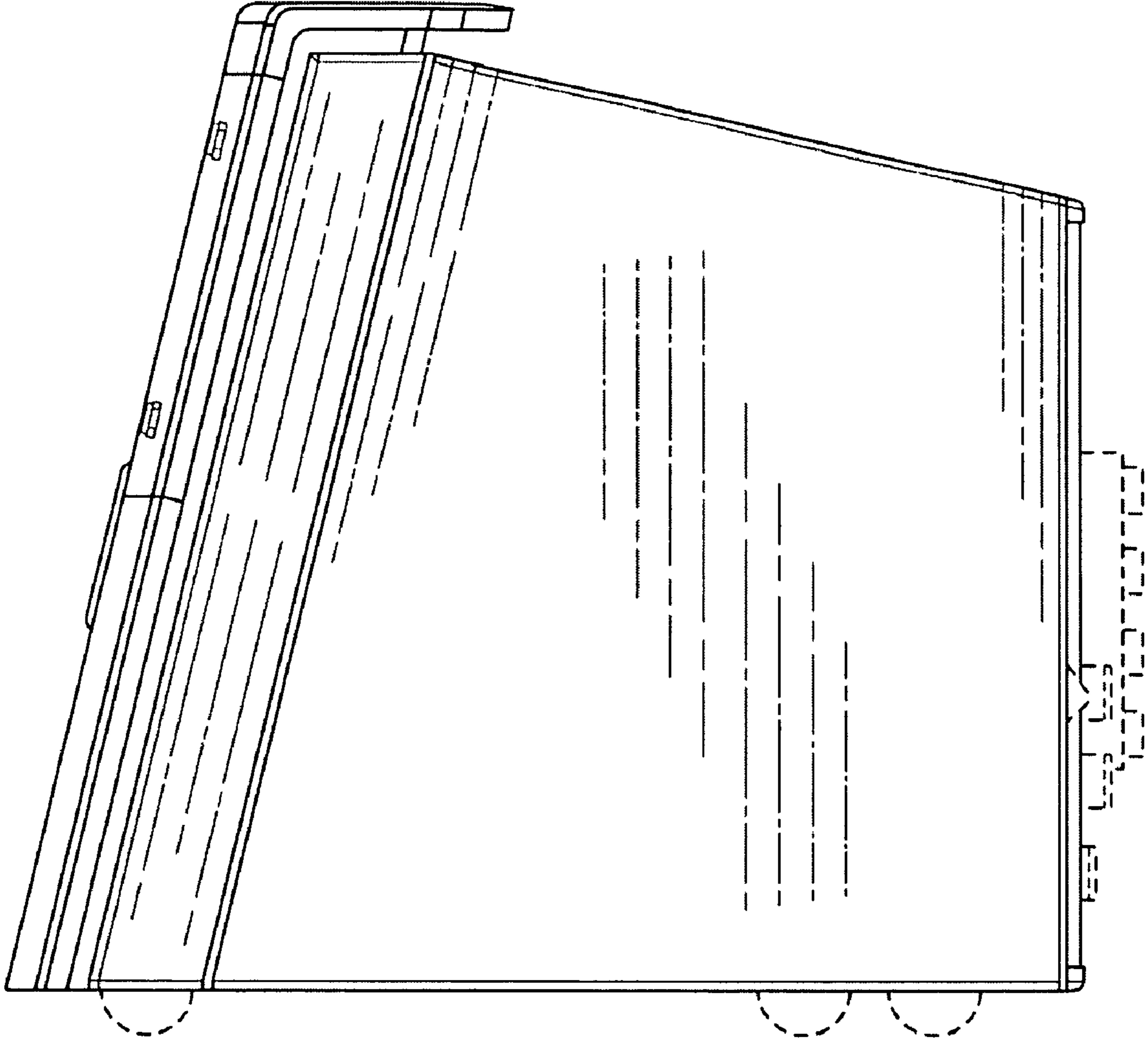

FIG. 2

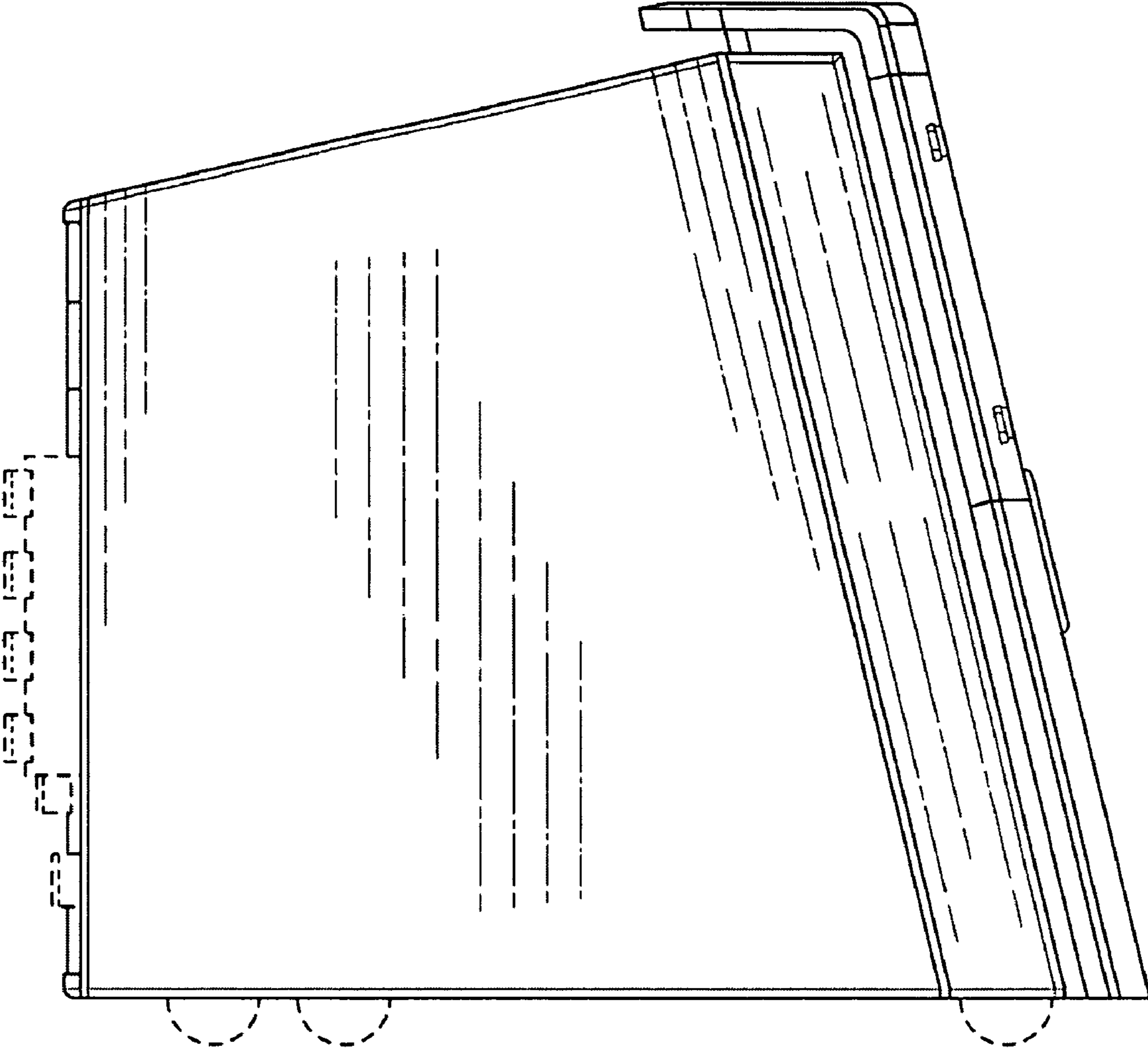

FIG. 3

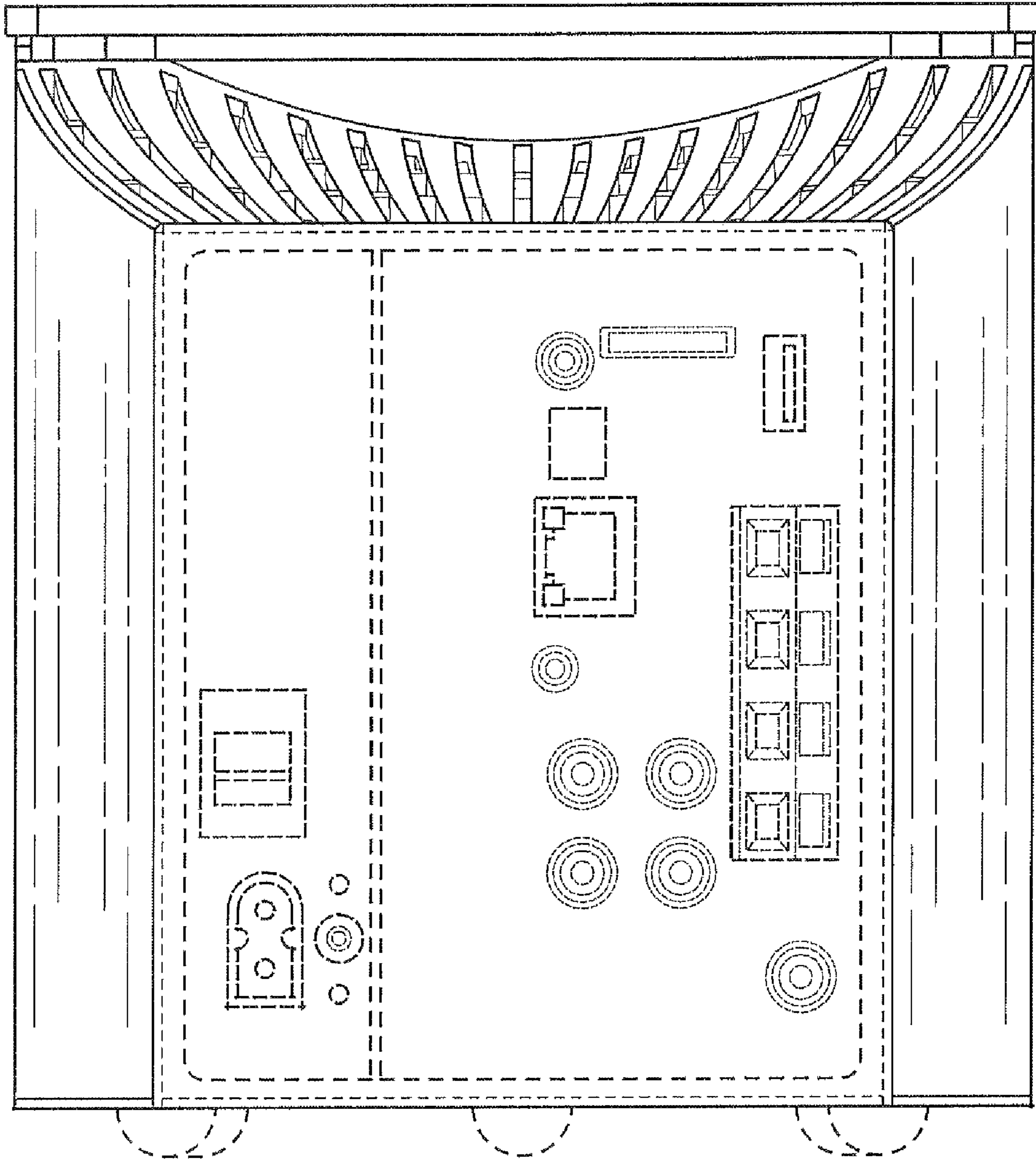

FIG. 4



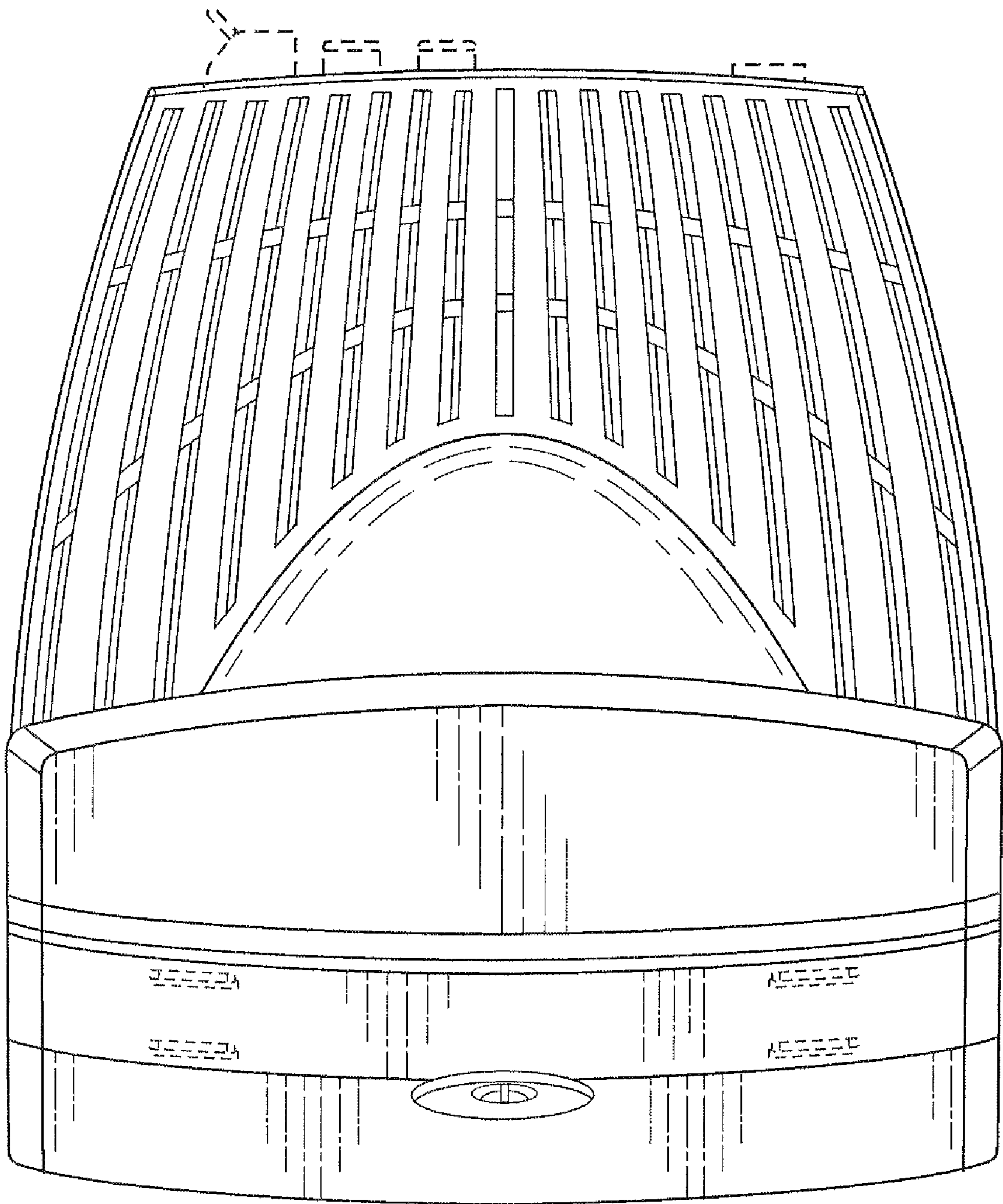

FIG. 5

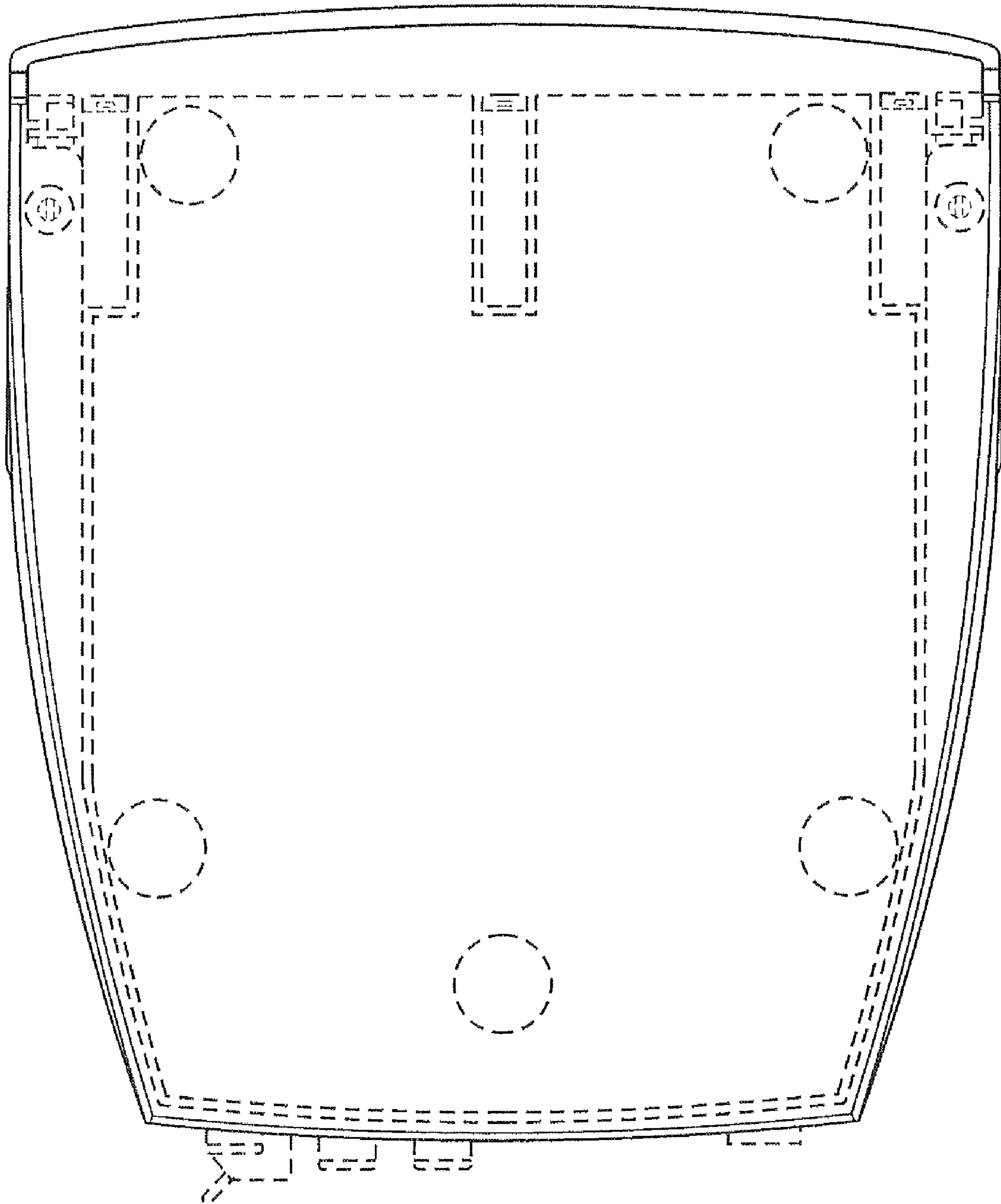

FIG. 6

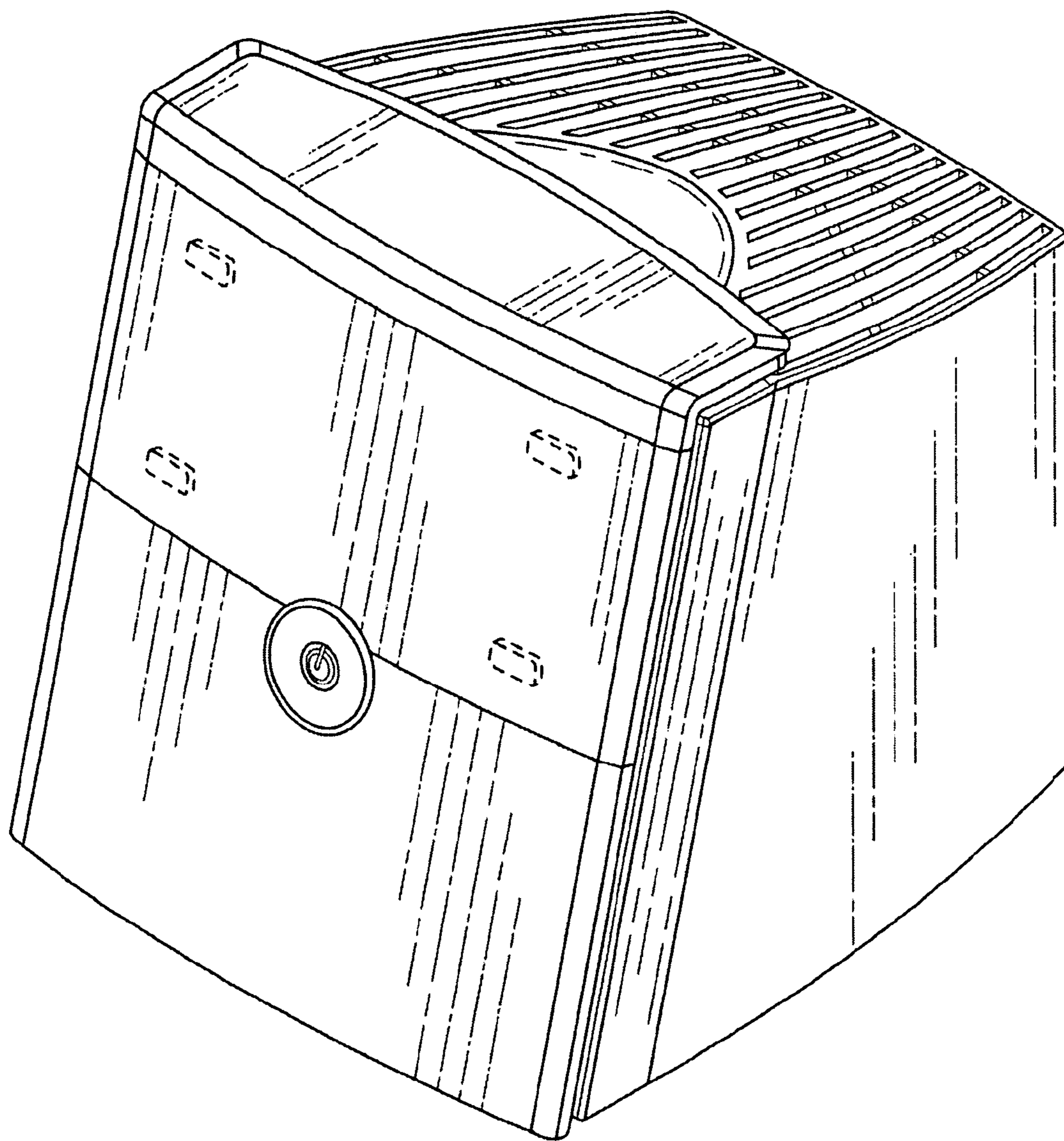

FIG. 7