



US00D611455S

(12) **United States Design Patent**
Wang et al.

(10) **Patent No.:** **US D611,455 S**

(45) **Date of Patent:** **** Mar. 9, 2010**

(54) **SPEAKER**

(75) Inventors: **Bowman Wang**, Ben Lomond, CA (US);
Minsung Kwon, San Jose, CA (US)

(73) Assignee: **Altec Lansing, LLC**, Milford, PA (US)

(**) Term: **14 Years**

(21) Appl. No.: **29/337,095**

(22) Filed: **May 14, 2009**

(51) **LOC (9) Cl.** **14-01**

(52) **U.S. Cl.** **D14/214**

(58) **Field of Classification Search** D14/204,
D14/207, 210–216, 172; 181/143–144, 147–148,
181/150–153, 157, 198–199; 381/300–303,
381/306, 332–333, 336, 345, 361–364, 386–388
See application file for complete search history.

(56) **References Cited**

U.S. PATENT DOCUMENTS

D280,984 S * 10/1985 Tricker D14/214
4,924,964 A * 5/1990 Olsen 181/151

D358,392 S * 5/1995 Yamazaki D14/213
D491,918 S * 6/2004 Solland D14/207
D550,203 S * 9/2007 Thomas D14/212

* cited by examiner

Primary Examiner—Nanda Bondade

(74) *Attorney, Agent, or Firm*—Greenberg Traurig LLP

(57) **CLAIM**

The ornamental design for a speaker, as shown and described.

DESCRIPTION

FIG. 1 is a front view of a speaker showing our new design;

FIG. 2 is a back view thereof;

FIG. 3 is a right side view thereof;

FIG. 4 is a left side view thereof;

FIG. 5 is a top view thereof; and,

FIG. 6 is a bottom view thereof.

The broken lines showing of the unclaimed environment forms no part of the claimed design.

1 Claim, 3 Drawing Sheets

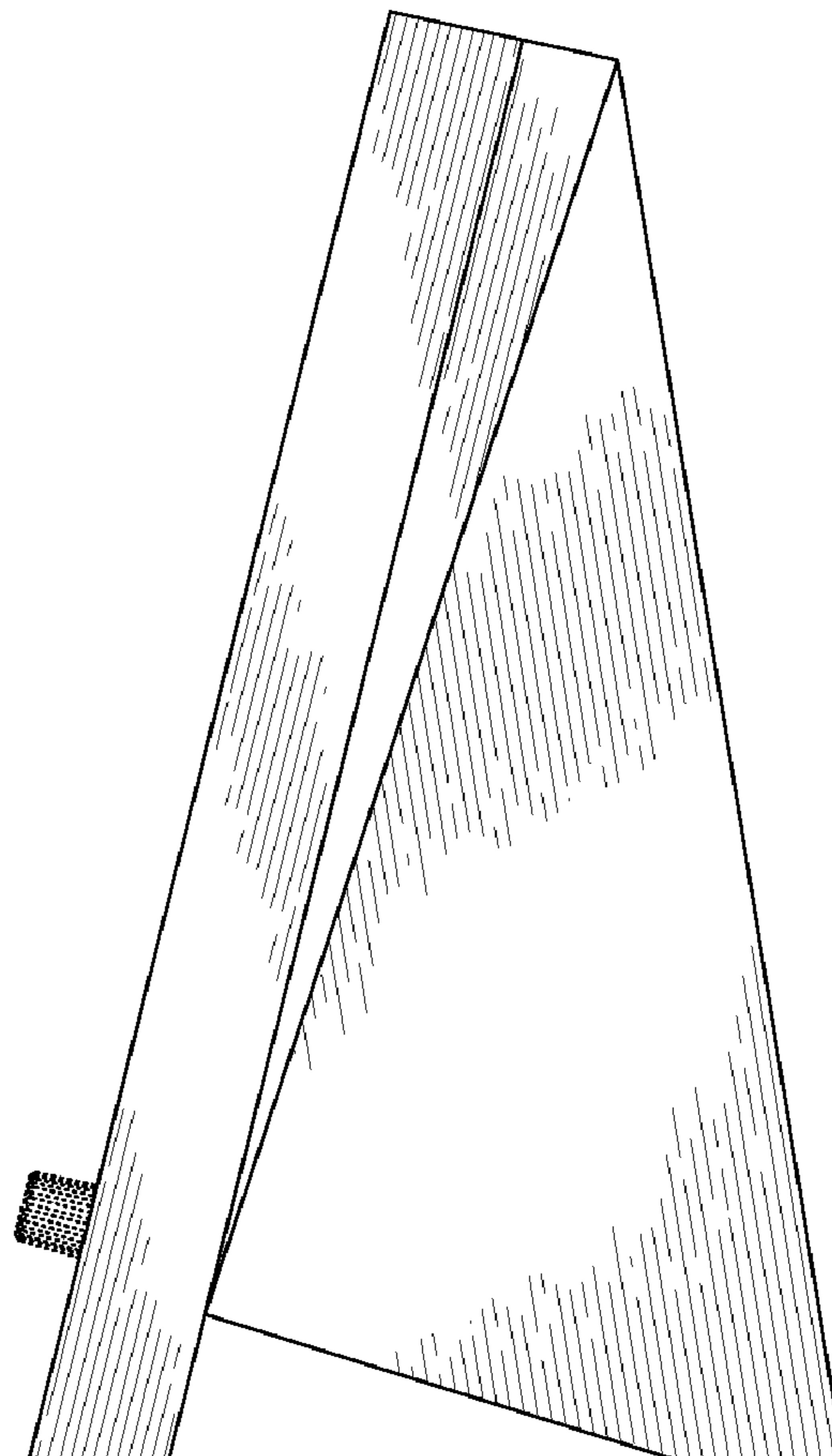
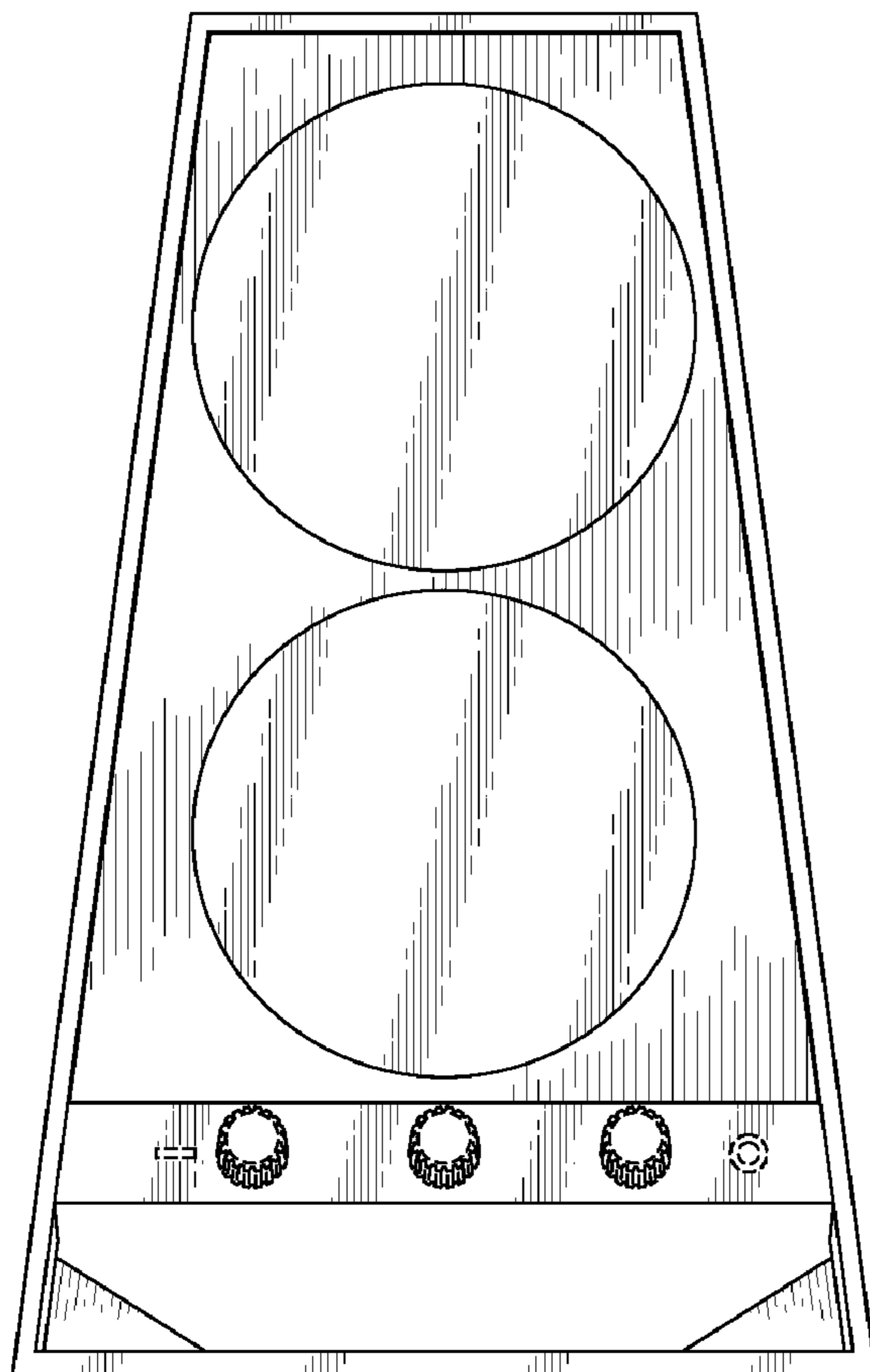

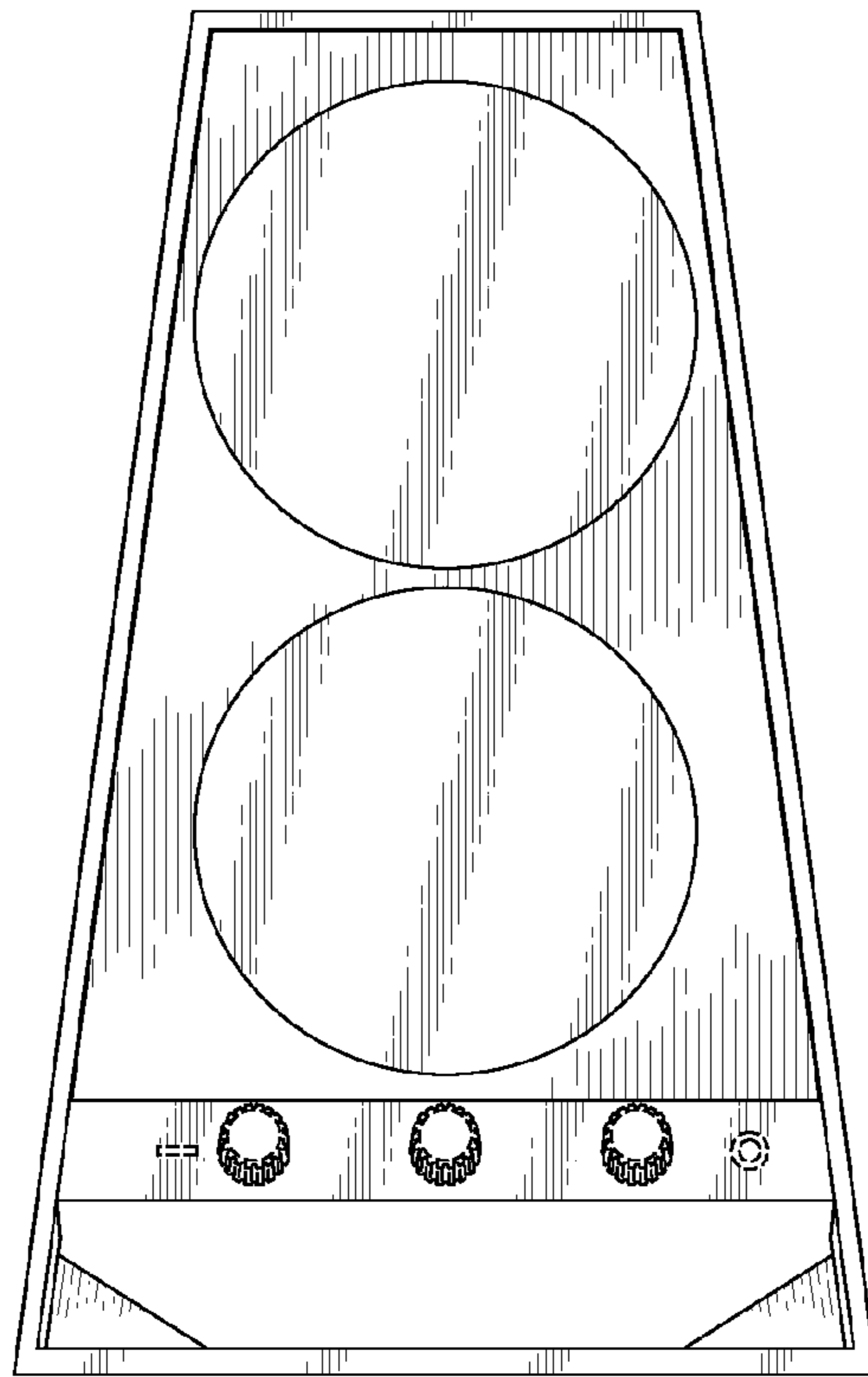

FIG. 1

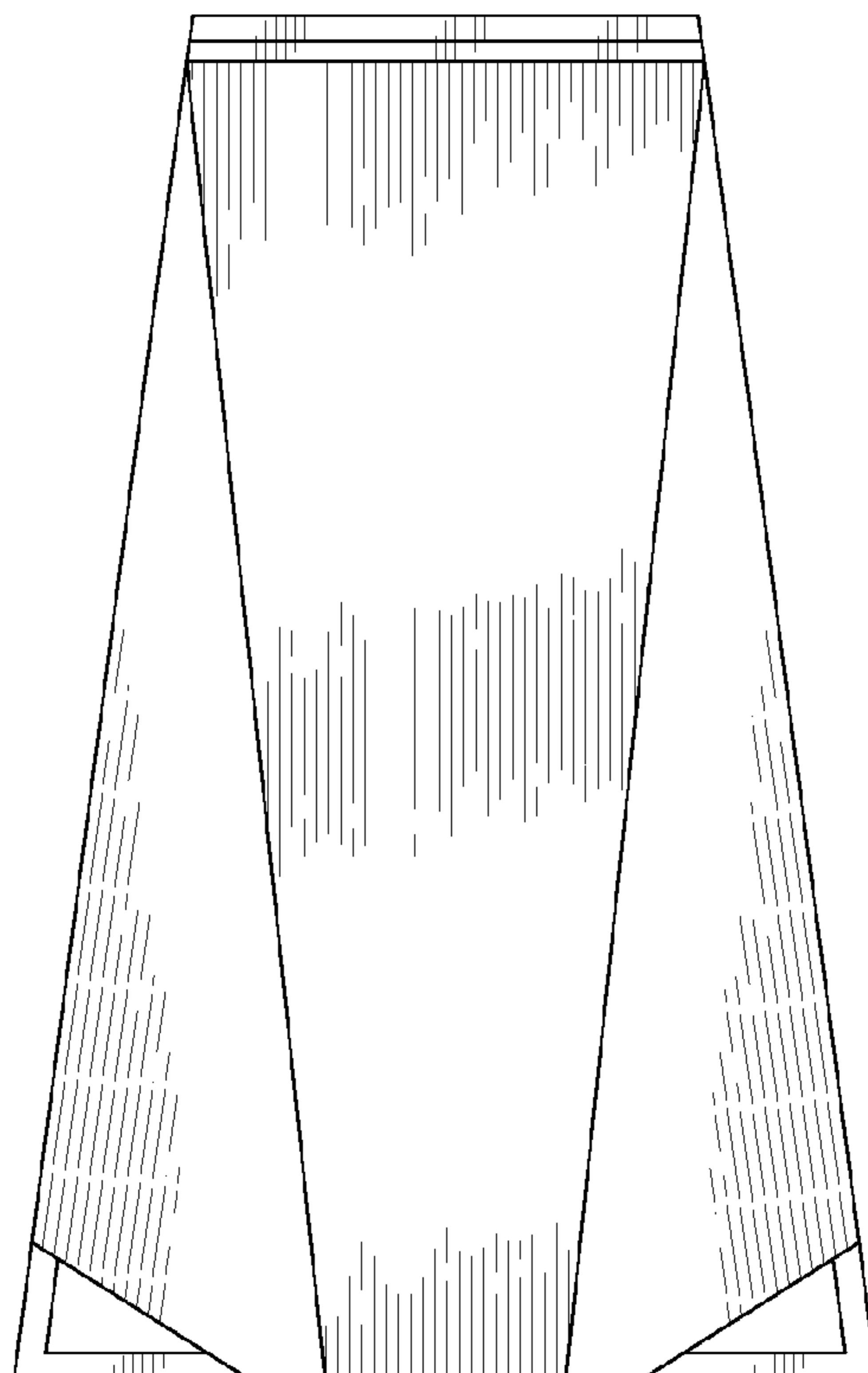

FIG. 2

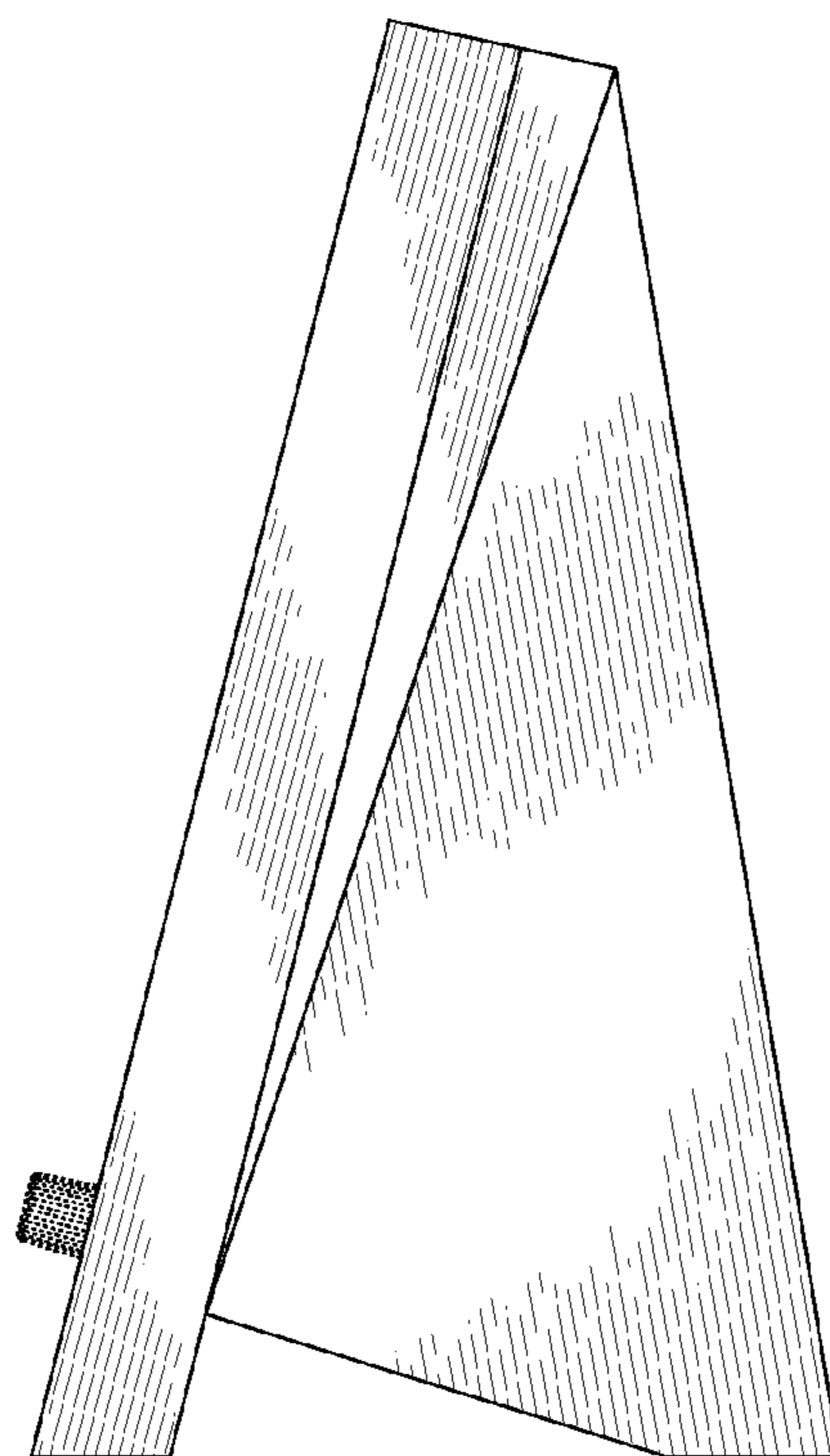

FIG. 3

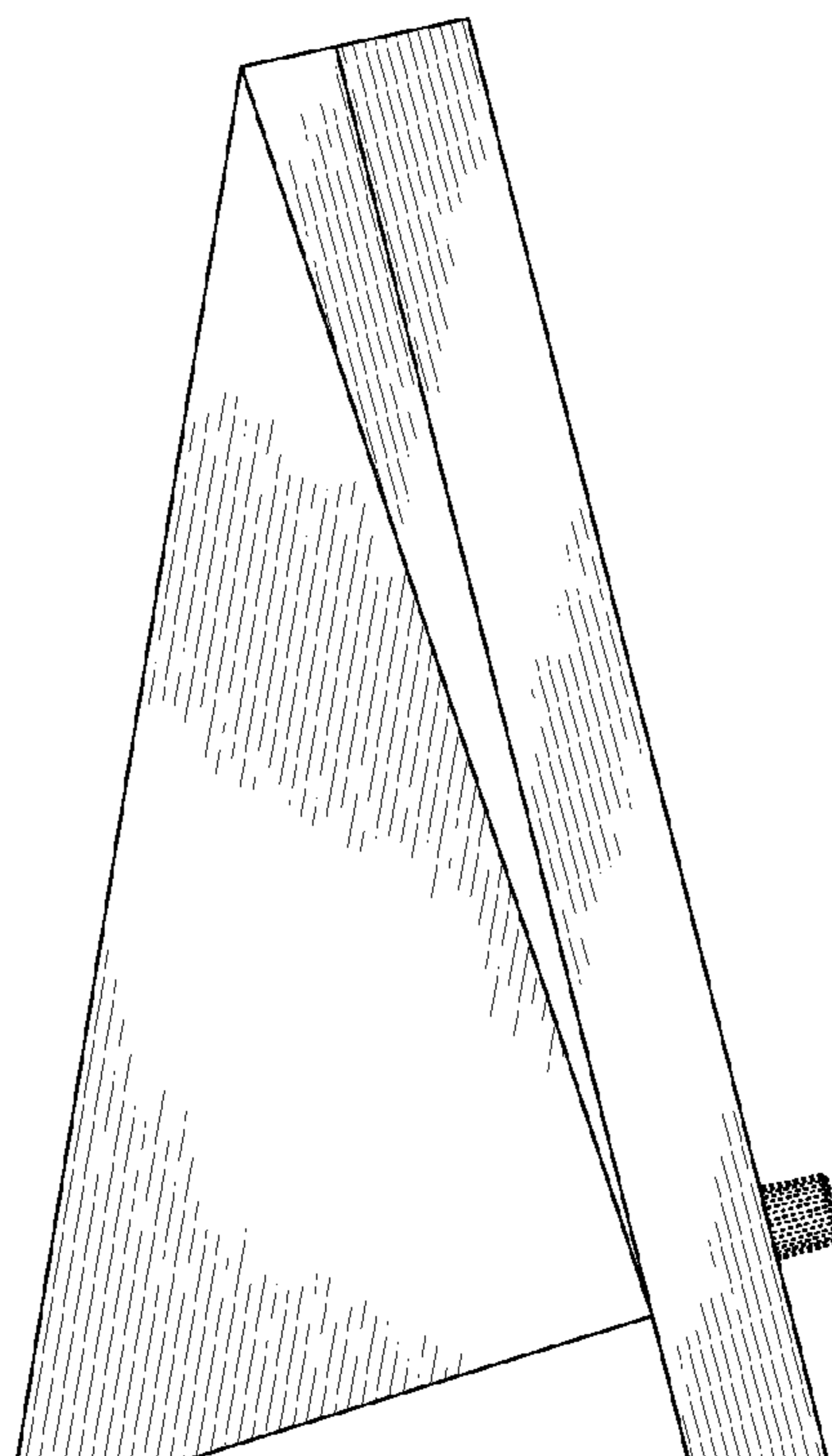

FIG. 4

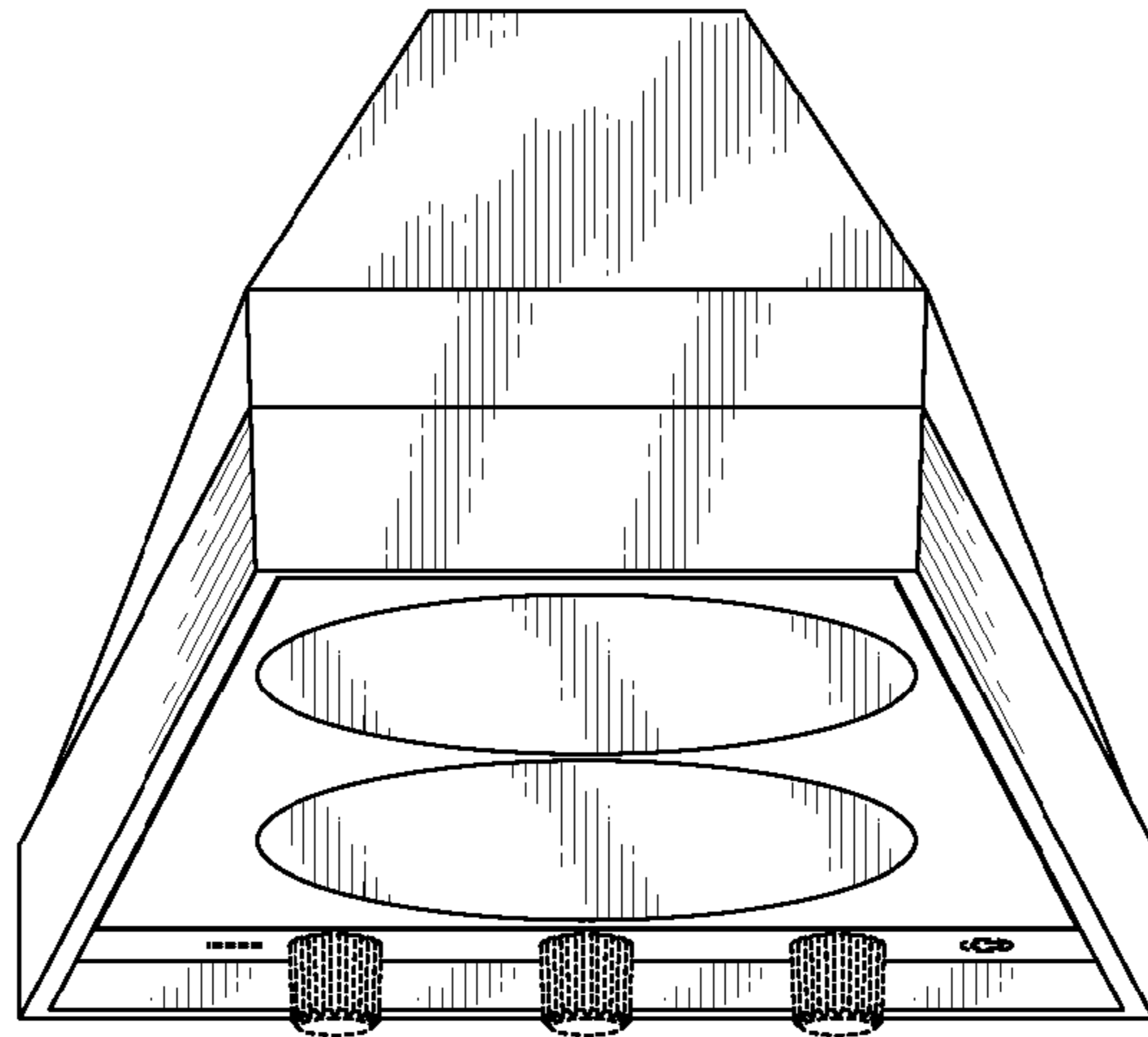

FIG. 5

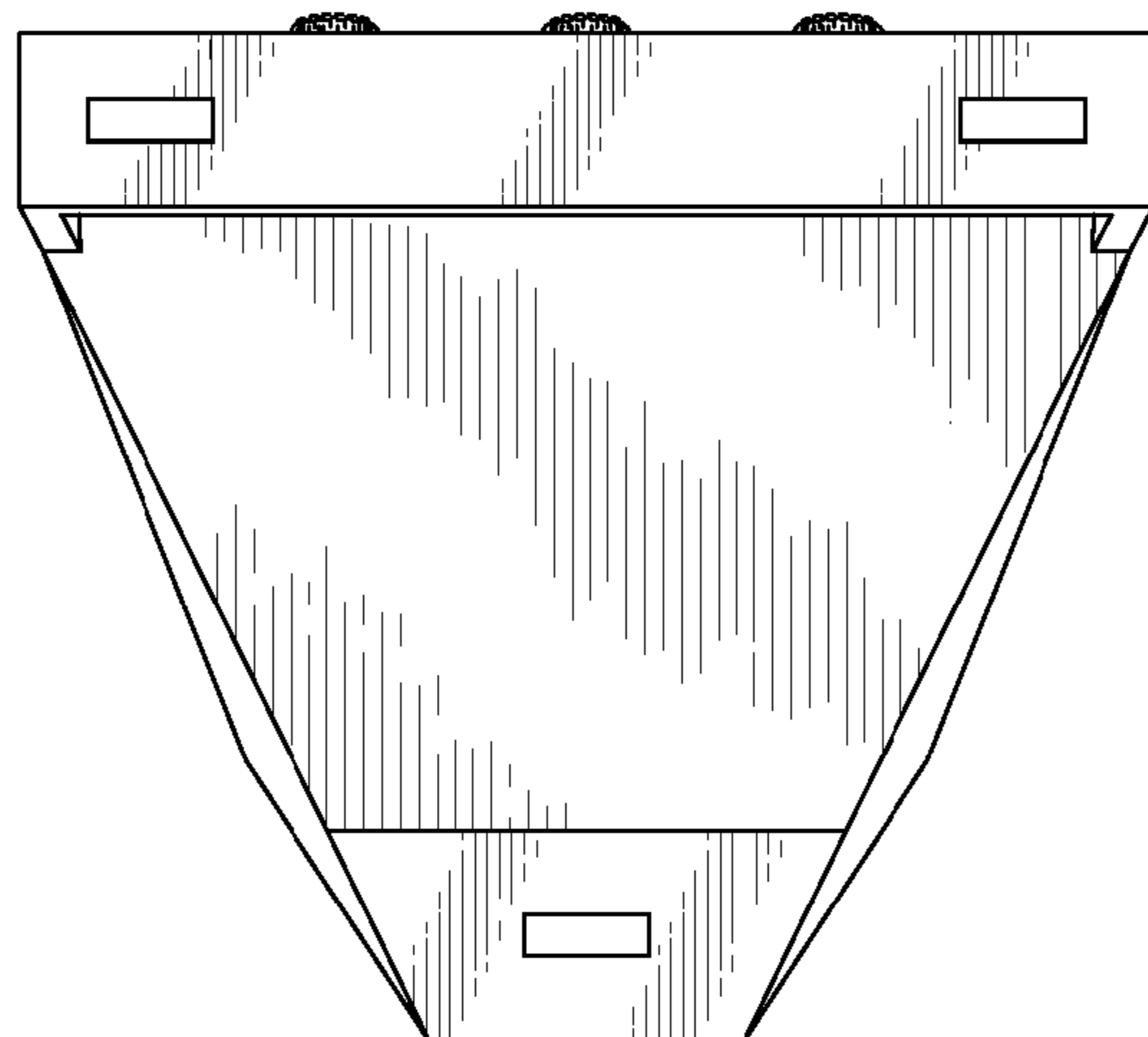

FIG. 6