



US00D611248S

(12) **United States Design Patent**
Vazquez

(10) **Patent No.:** **US D611,248 S**
(45) **Date of Patent:** **** Mar. 9, 2010**

(54) **MID SECTIONAL GATHERABLE BAG**

(76) Inventor: **Maximino Vazquez**, 213 W. 14th St.,
New York, NY (US) 10011

(**) Term: **14 Years**

(21) Appl. No.: **29/315,047**

(22) Filed: **May 21, 2009**

Related U.S. Application Data

(63) Continuation-in-part of application No. 29/273,588,
filed on Mar. 9, 2007, now Pat. No. Des. 592,397.

(51) **LOC (9) Cl.** **03-01**

(52) **U.S. Cl.** **D3/244**

(58) **Field of Classification Search** D3/244;
150/100, 107-108, 129-130

See application file for complete search history.

Primary Examiner—Holly H Baynham

(74) *Attorney, Agent, or Firm*—Darby & Darby

(57) **CLAIM**

The ornamental design for a mid sectional gatherable bag, as shown and described.

DESCRIPTION

FIG. 1 is a front elevational view of the first embodiment of a mid sectional gatherable bag in an uncompressed state, the rear elevational view being a mirror image thereof.

FIG. 2 is a left side perspective view of FIG. 1, the right side perspective view being a mirror image thereof.

FIG. 3 is a top front perspective view of FIG. 1

FIG. 4 is a bottom rear perspective view of FIG. 1

FIG. 5 is a front elevational view of the first embodiment of a mid sectional gatherable bag compressed at the center of the bag, the rear elevational view being a mirror image thereof.

FIG. 6 is a left side perspective view of a FIG. 5, the right side perspective view being a mirror image thereof.

FIG. 7 is a top front perspective view of FIG. 5

FIG. 8 is a bottom perspective view of FIG. 5

FIG. 9 is a front elevational view of the first embodiment of a mid sectional gatherable bag compressed at the center of the bag and at the sides, the rear elevational view being a mirror image thereof.

FIG. 10 is a left side perspective view of a FIG. 9, the right side perspective view being a mirror image thereof.

FIG. 11 is a top front perspective view of FIG. 9

FIG. 12 is a bottom rear perspective view of FIG. 9

FIG. 13 is a front elevational view of the second embodiment of a mid sectional gatherable bag in an uncompressed state, the rear elevational view being a mirror image thereof.

FIG. 14 is a top front perspective view of FIG. 13

FIG. 15 is a bottom rear perspective view of FIG. 13

FIG. 16 is a front elevational view of the second embodiment of a mid sectional gatherable bag compressed at the center of the bag, the rear elevational view being a mirror image thereof

FIG. 17 is a top front perspective view of FIG. 16

FIG. 18 is a bottom rear perspective view of FIG. 16

FIG. 19 is a front elevational view of the second embodiment of a mid sectional gatherable bag compressed at the center of the bag and at the sides, the rear elevational view being a mirror image thereof.

FIG. 20 is a top front perspective view of FIG. 19; and,

FIG. 21 is a bottom rear perspective view of FIG. 19.

The broken lines showing the webbing, and stitching are to show environment only and are not part of the claimed design.

1 Claim, 9 Drawing Sheets

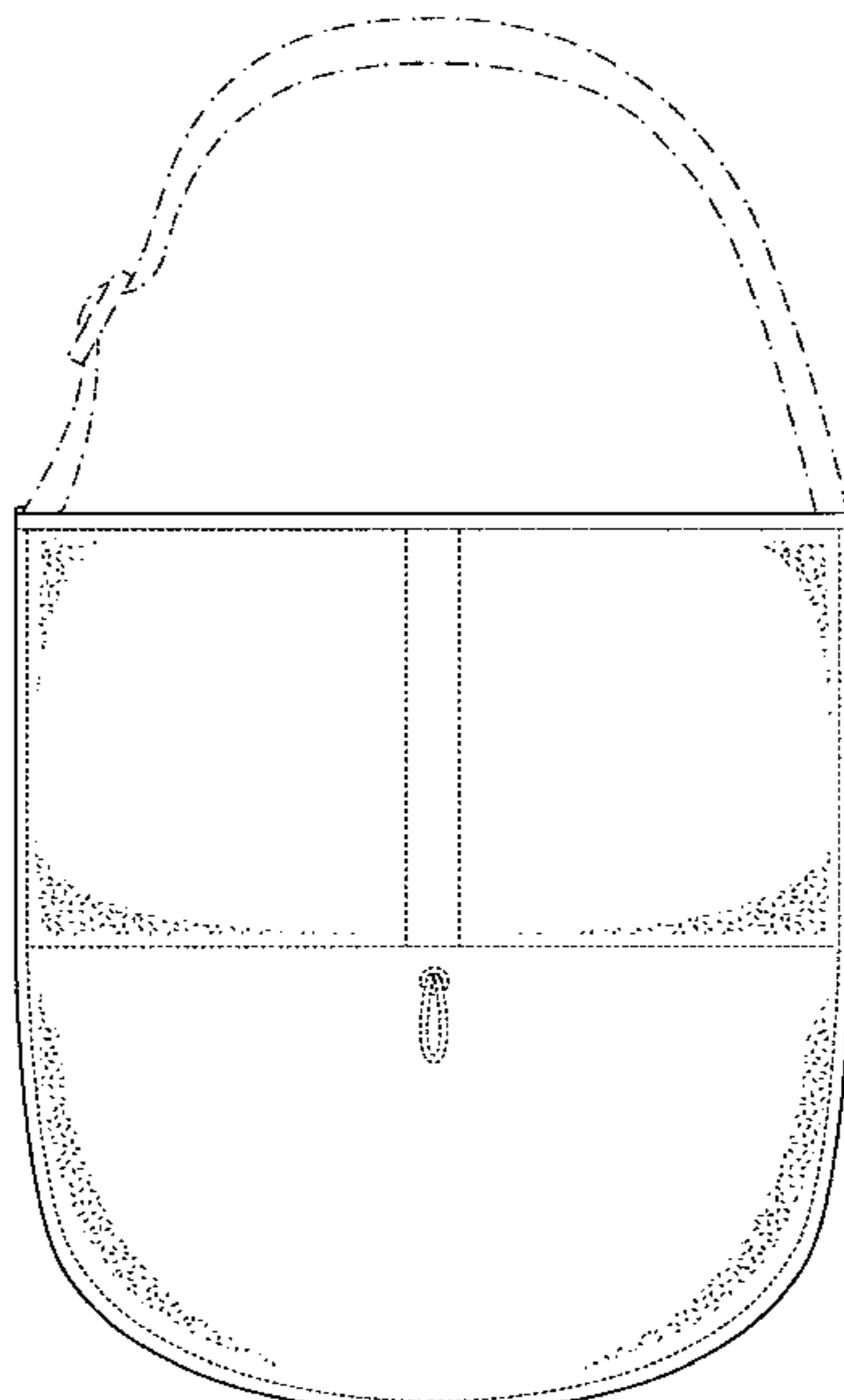

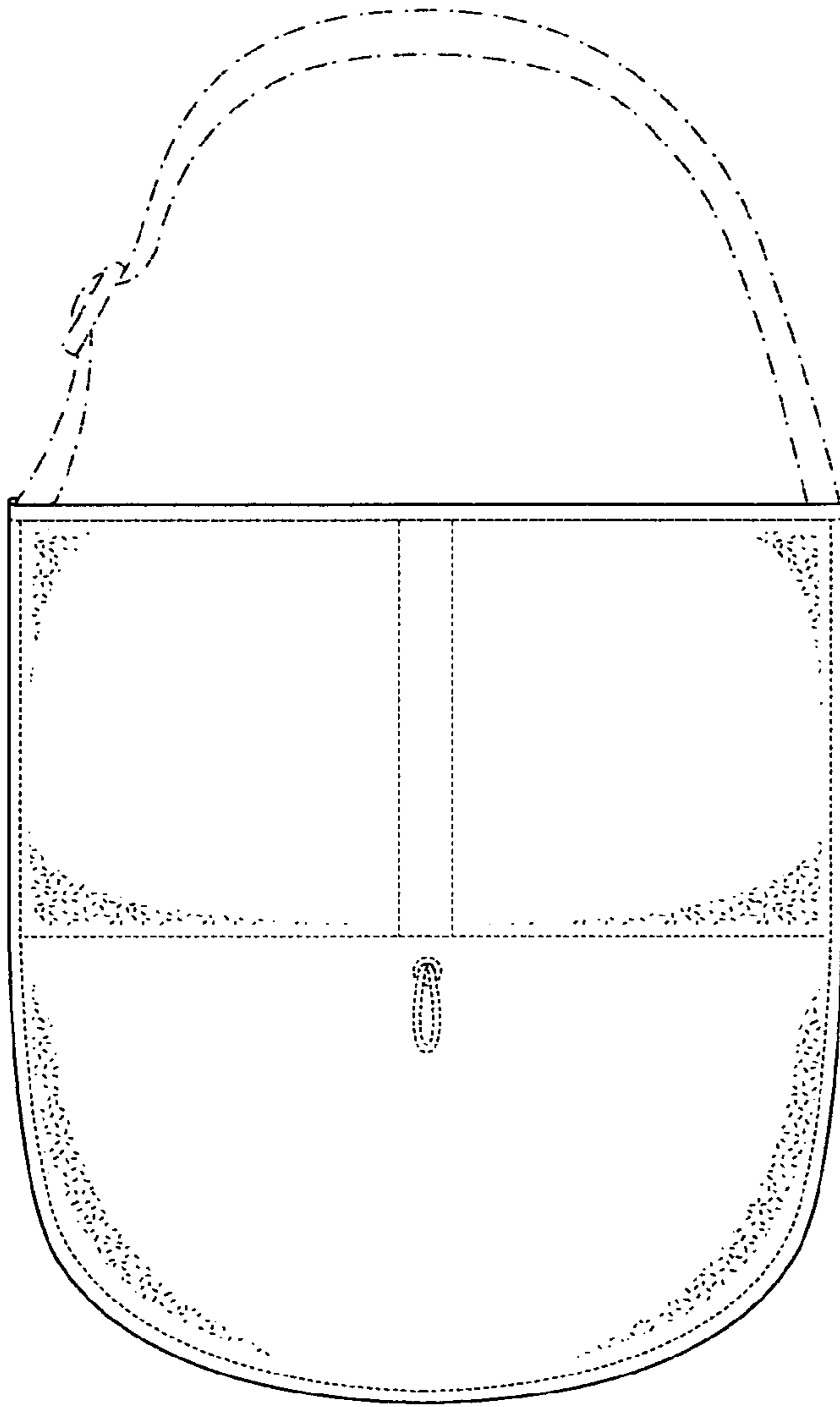

FIG. 1

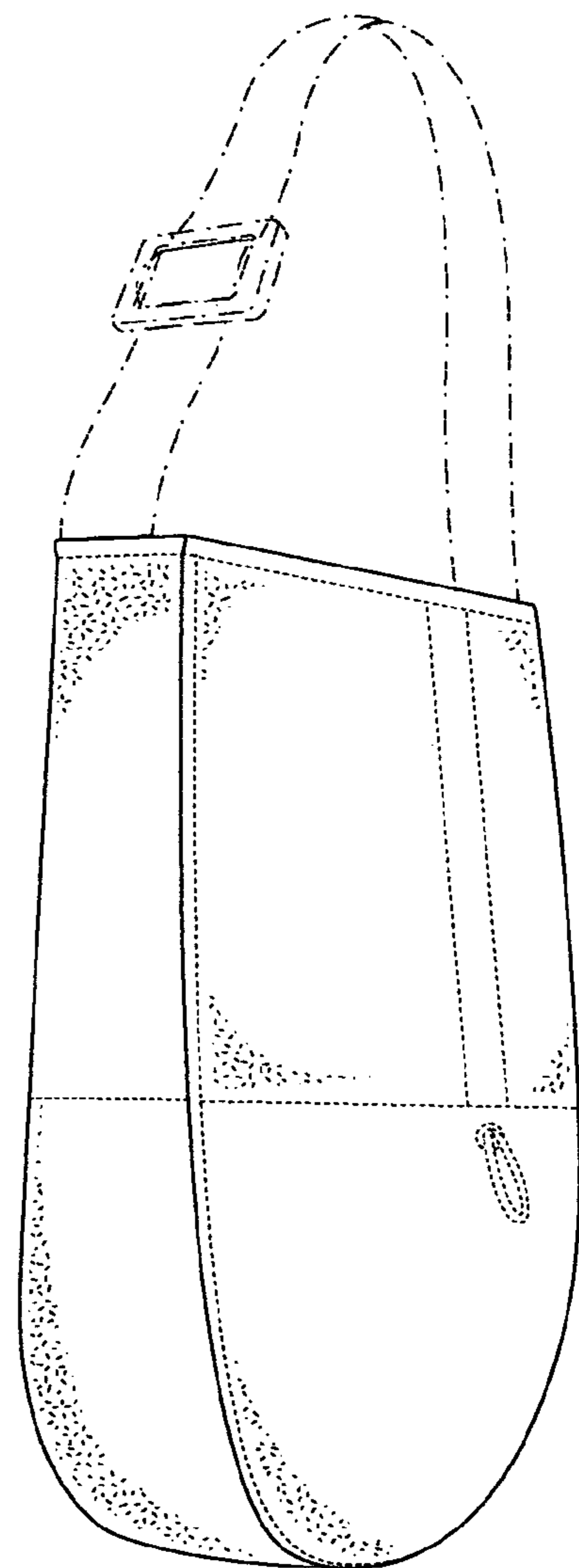

FIG. 2

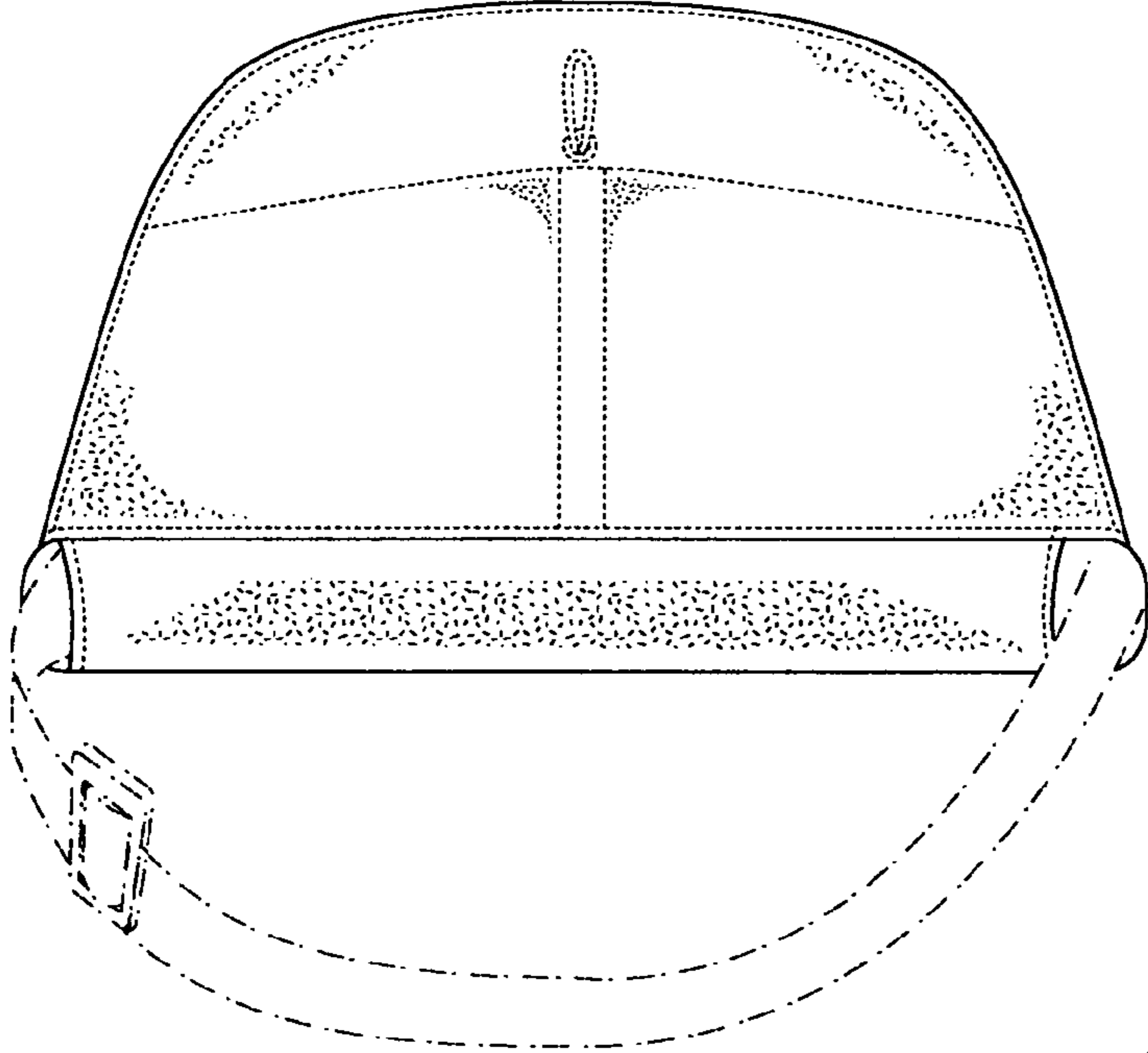

FIG. 3

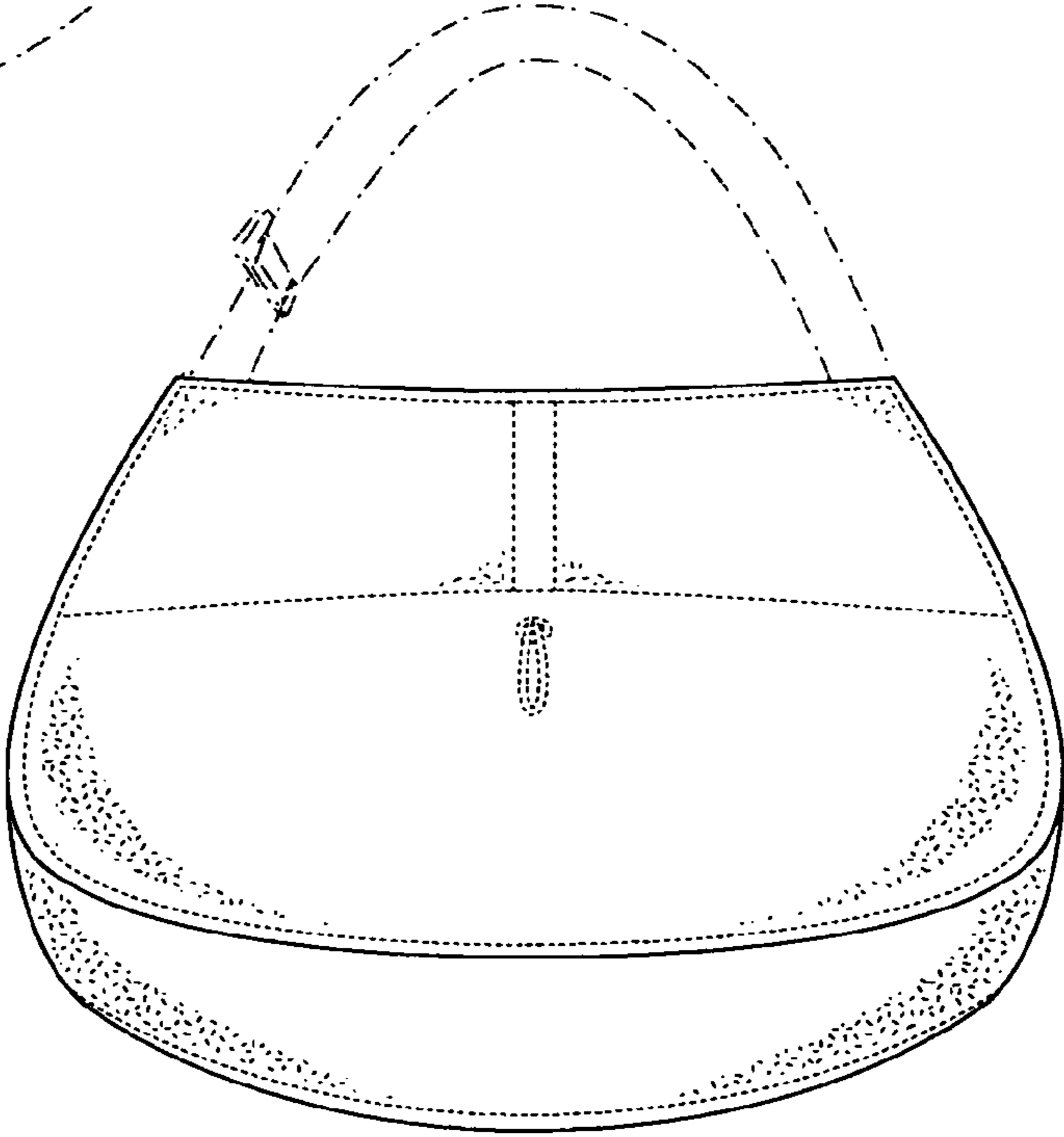

FIG. 4

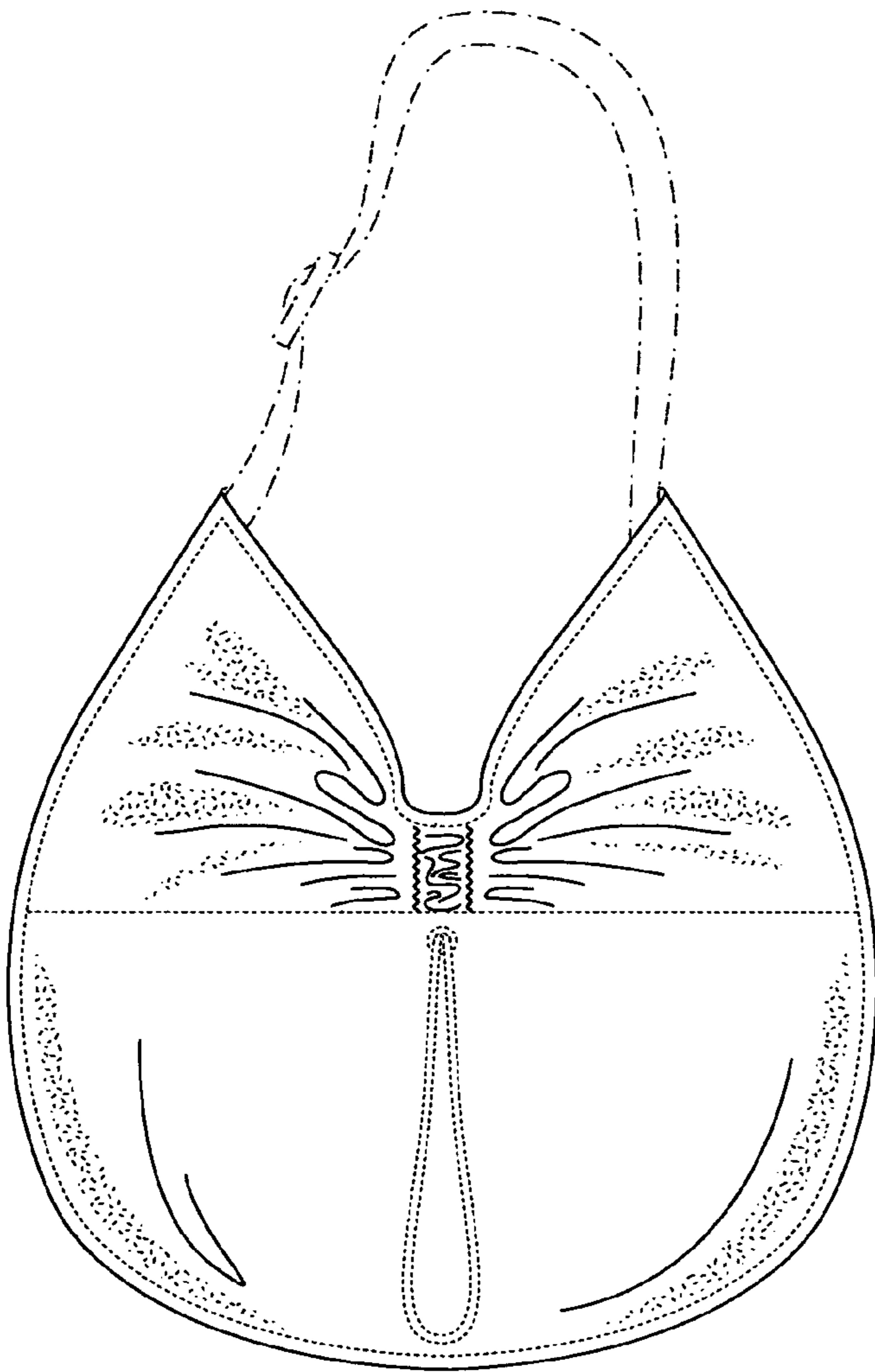

FIG. 5

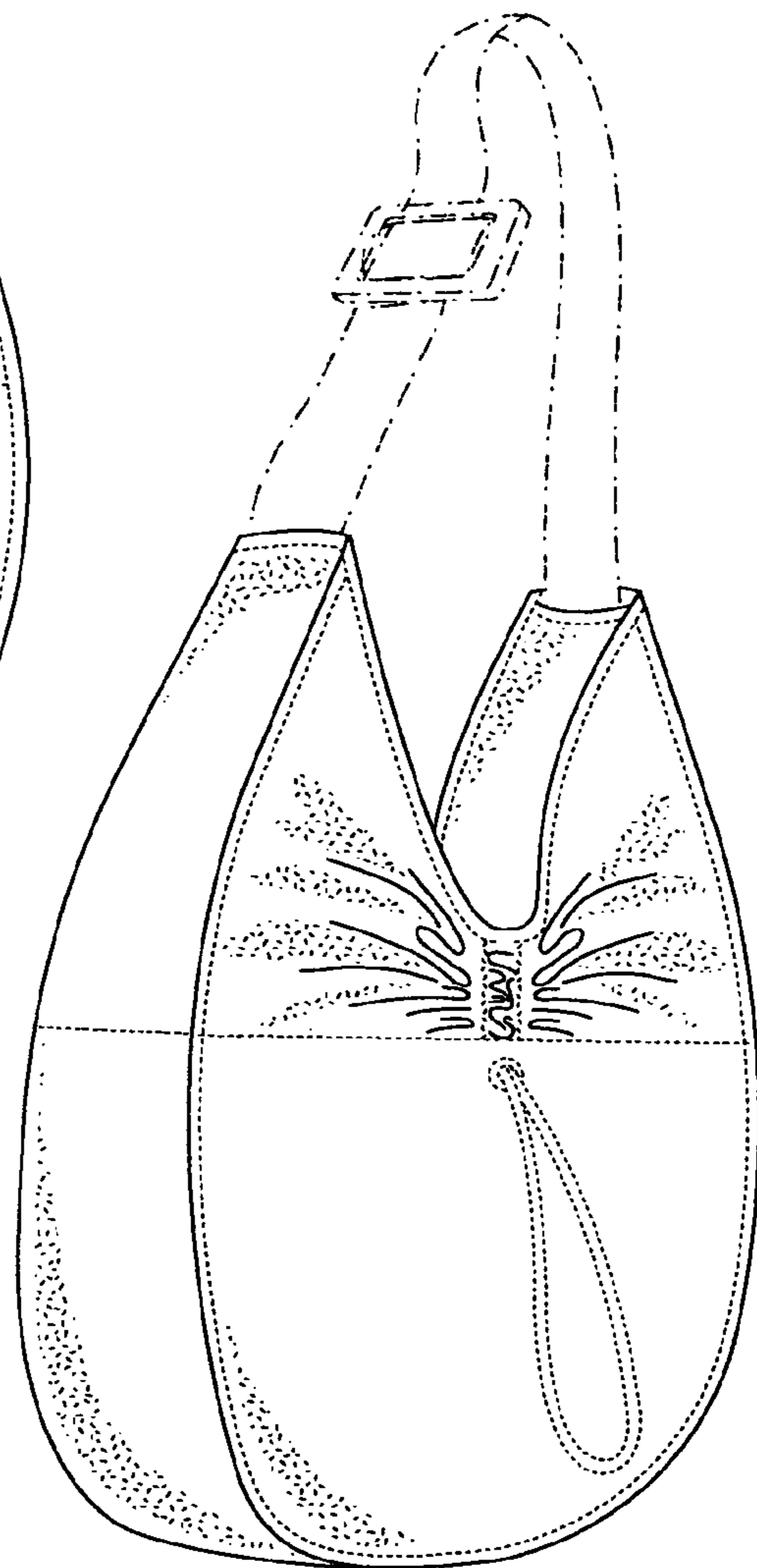

FIG. 6

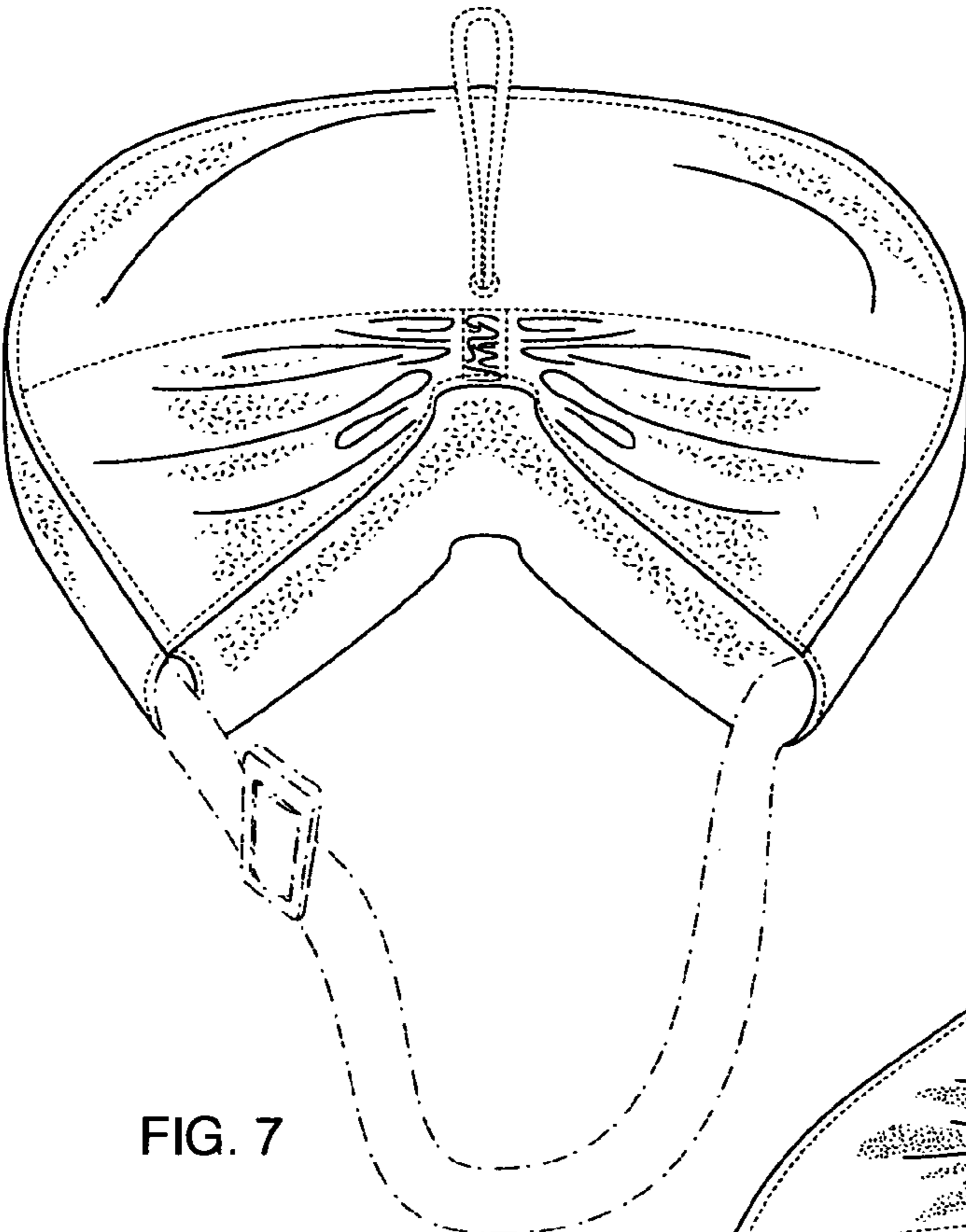

FIG. 7

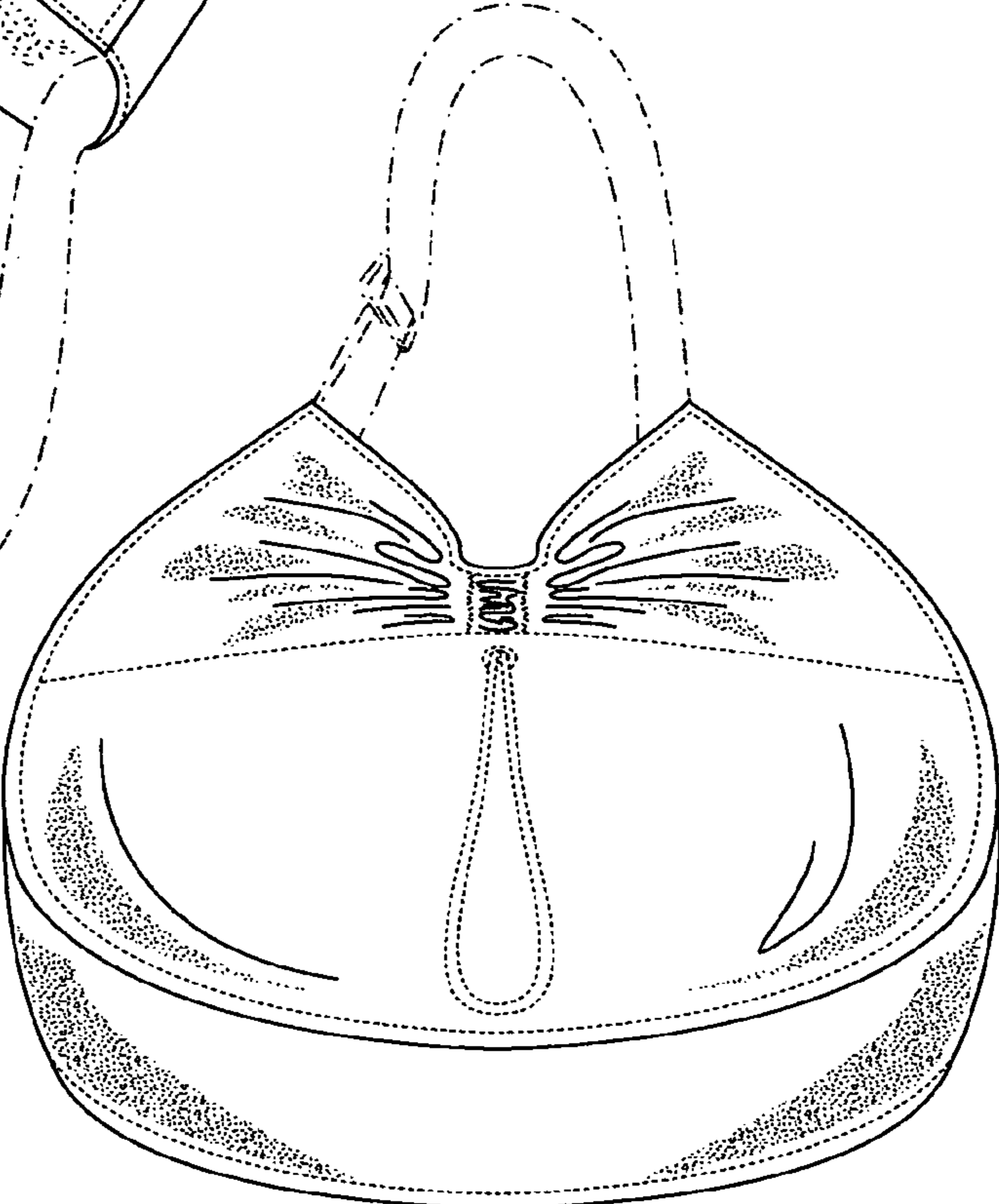

FIG. 8

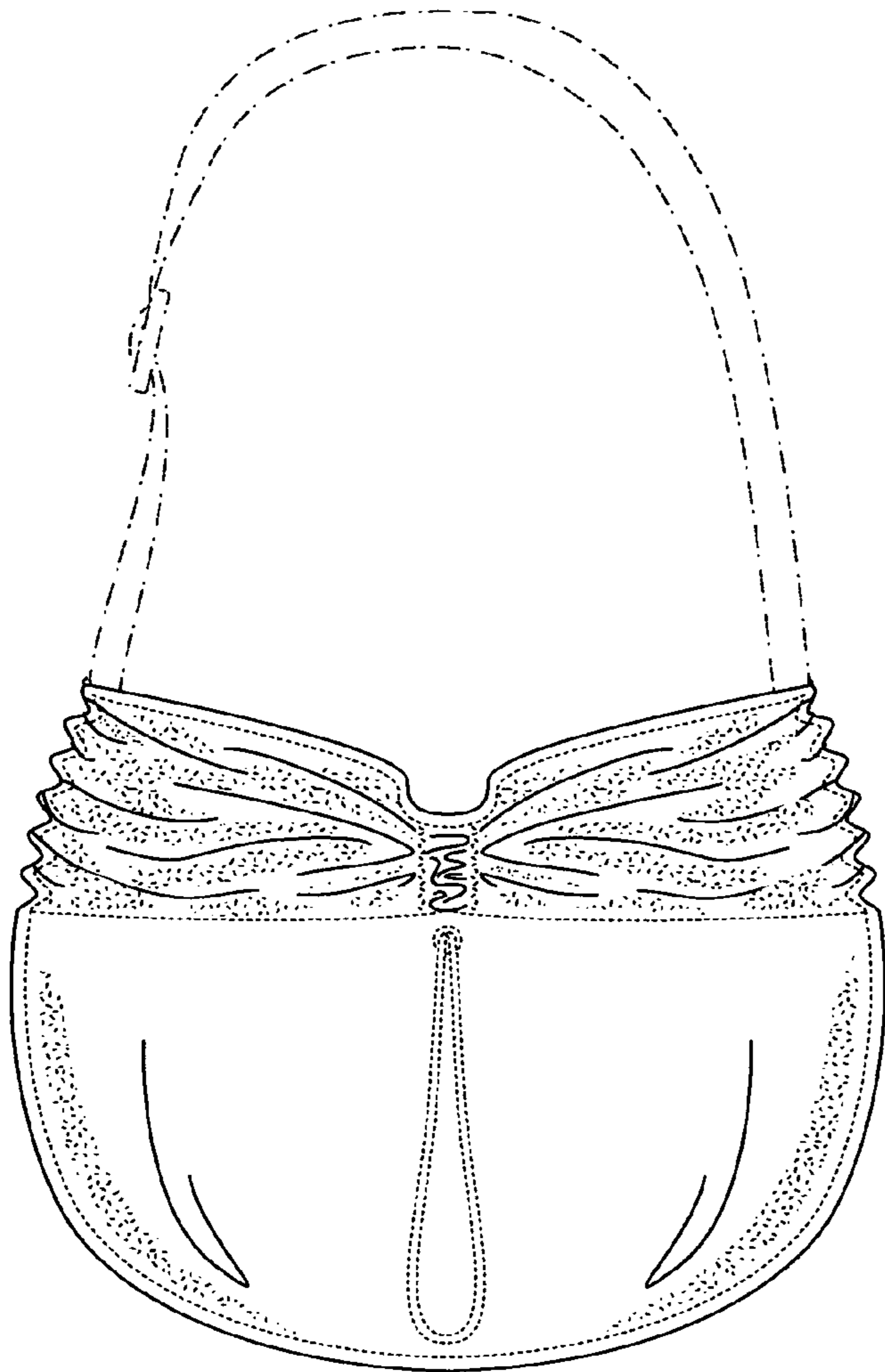

FIG. 9

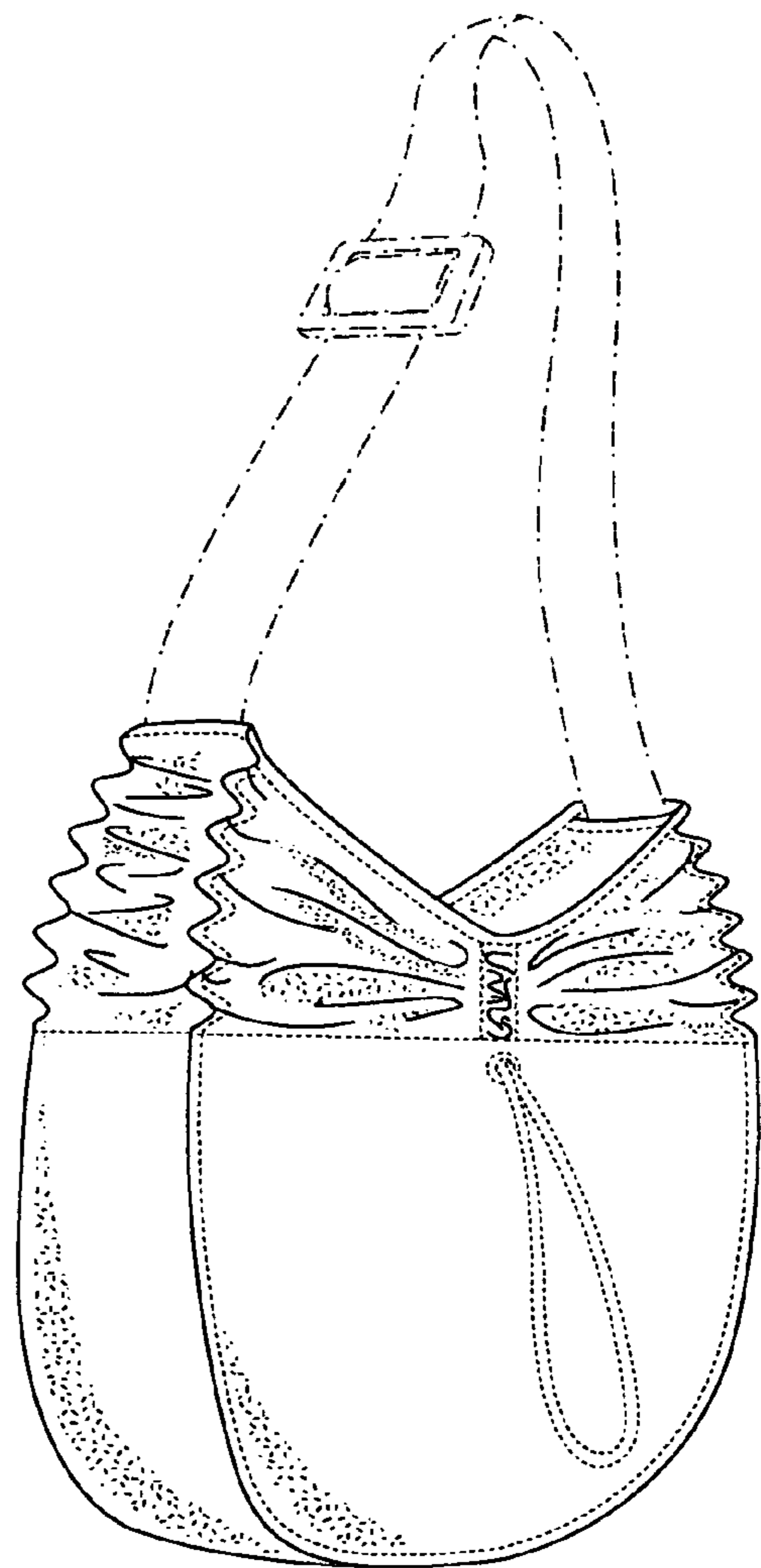

FIG. 10

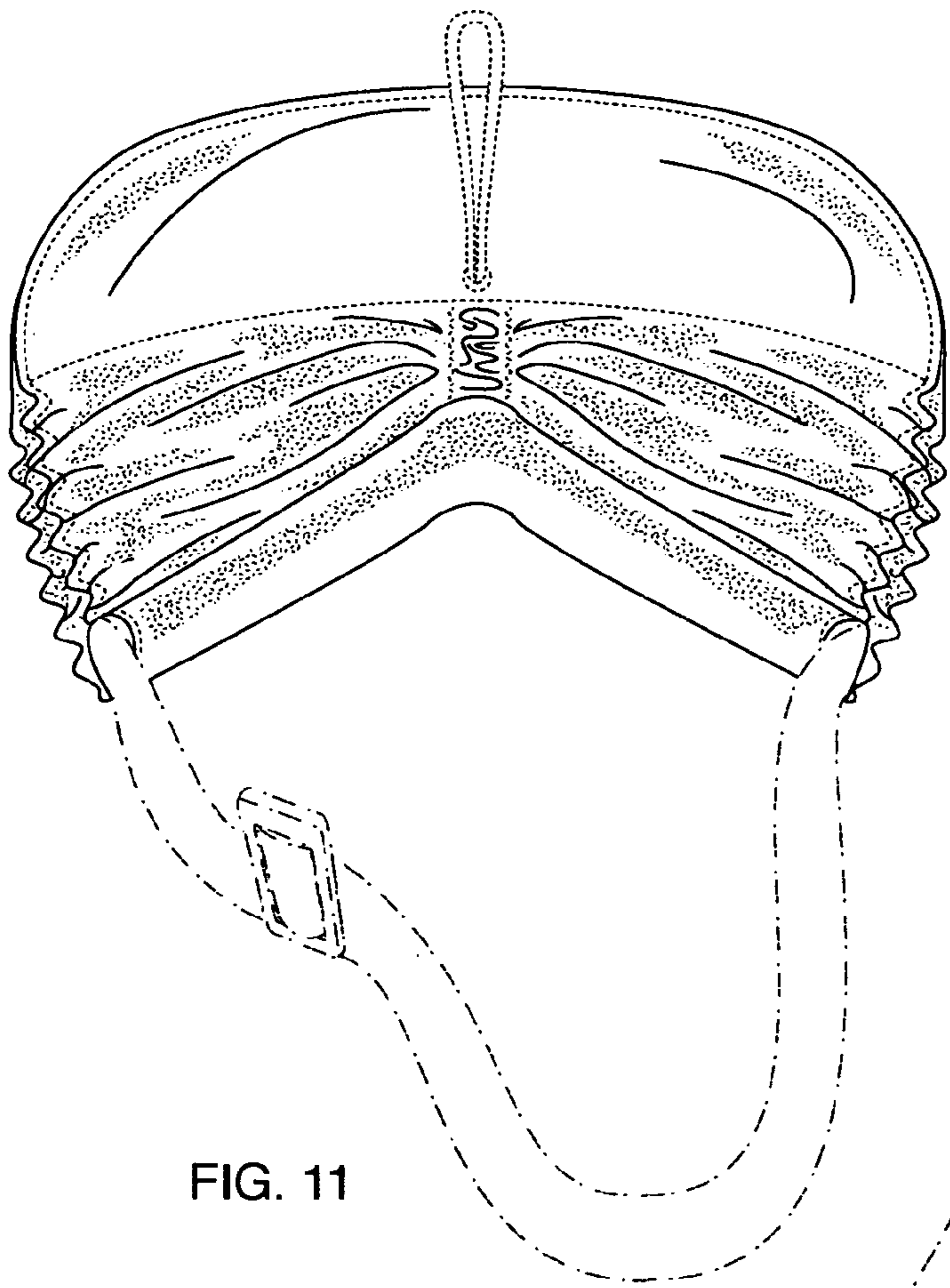

FIG. 11

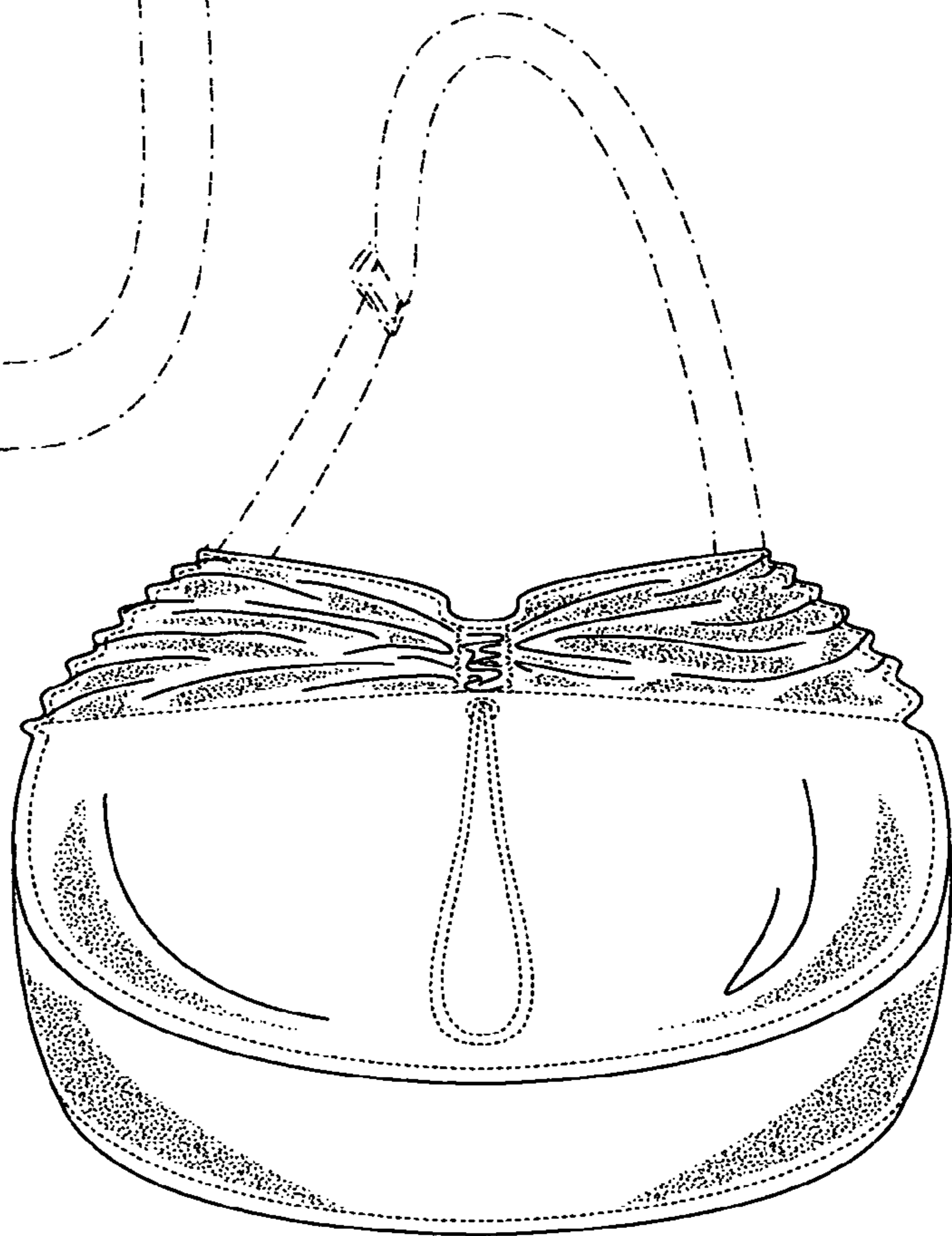

FIG. 12

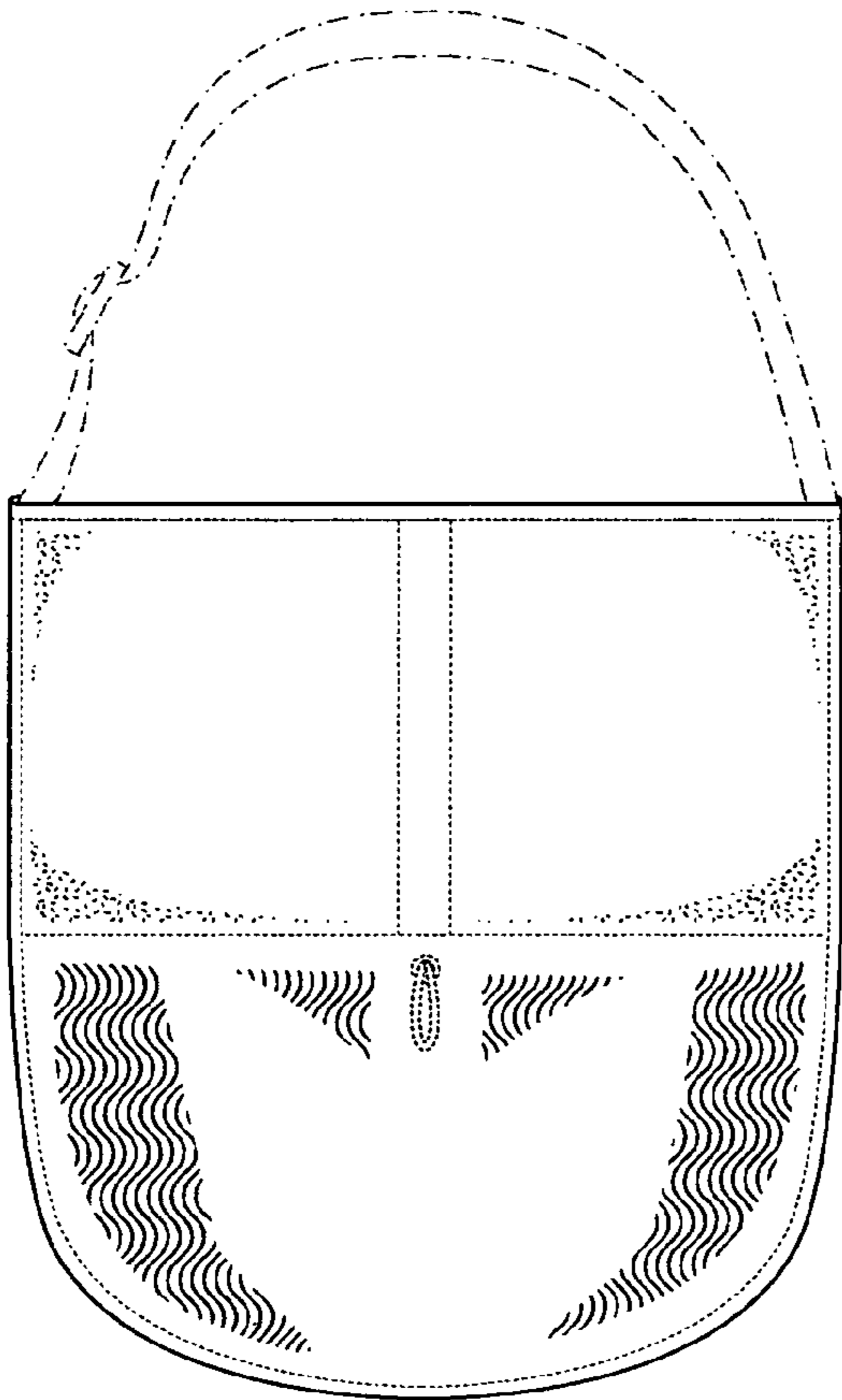

FIG. 13

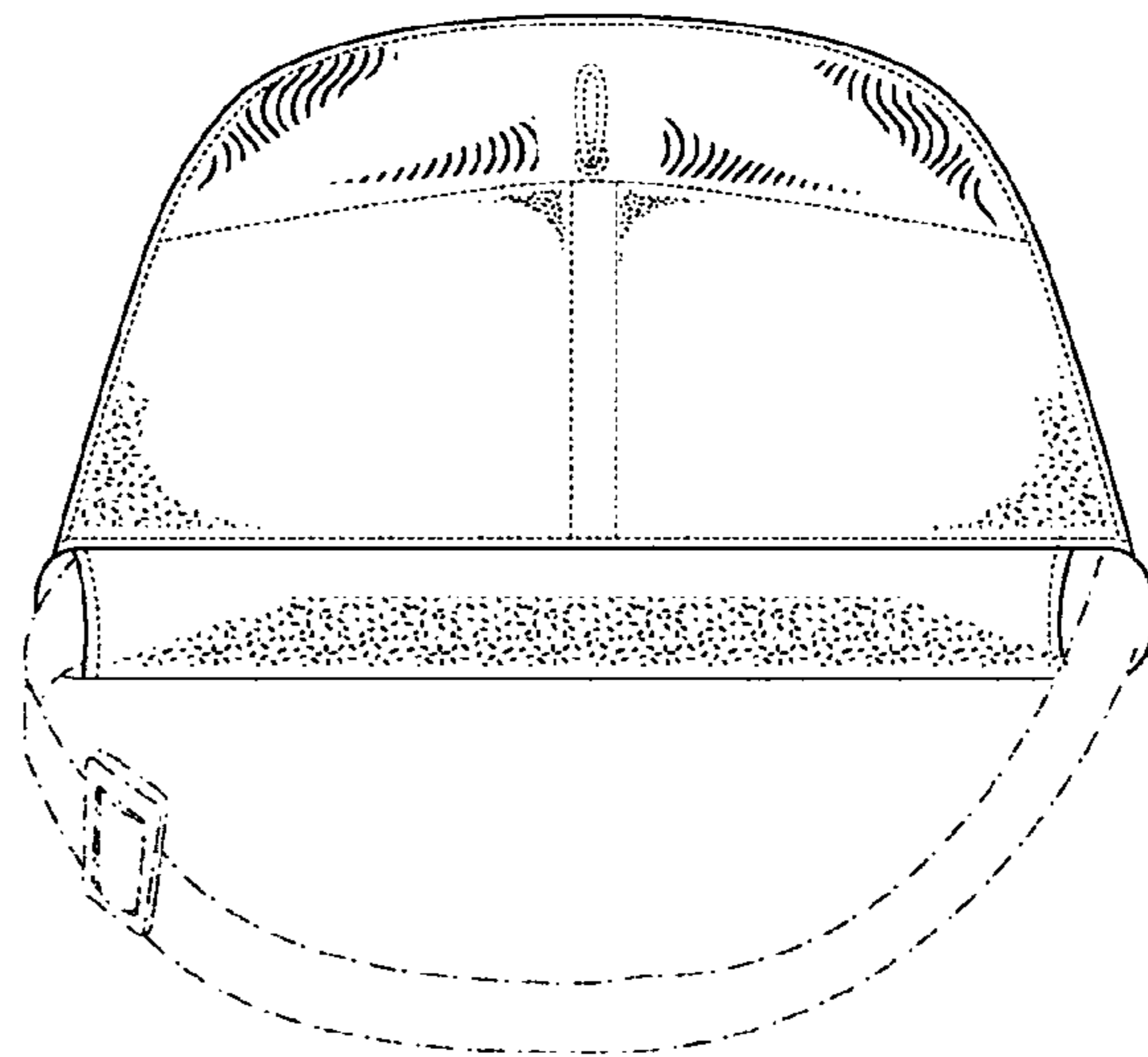

FIG. 14

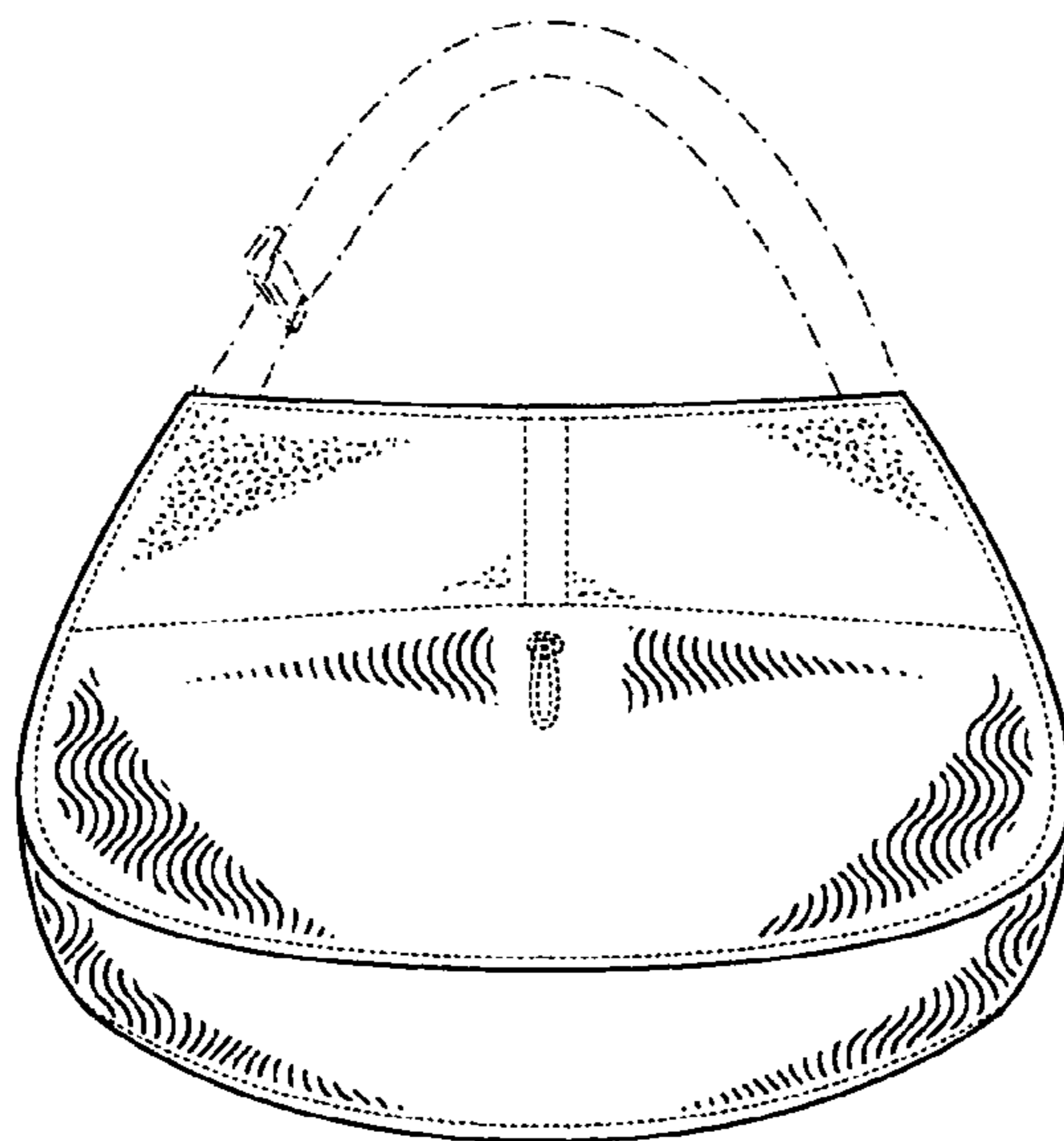

FIG. 15

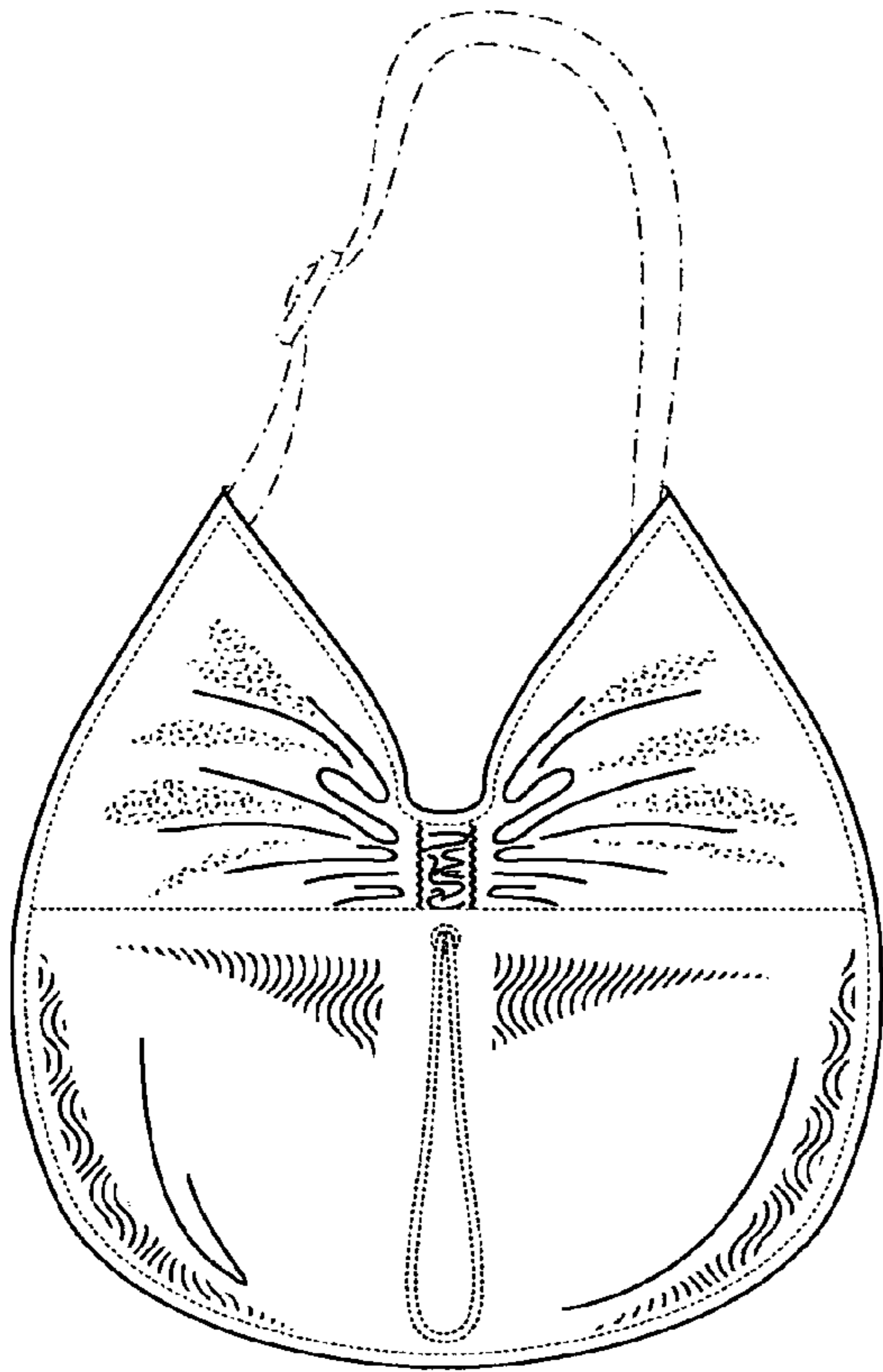

FIG. 16

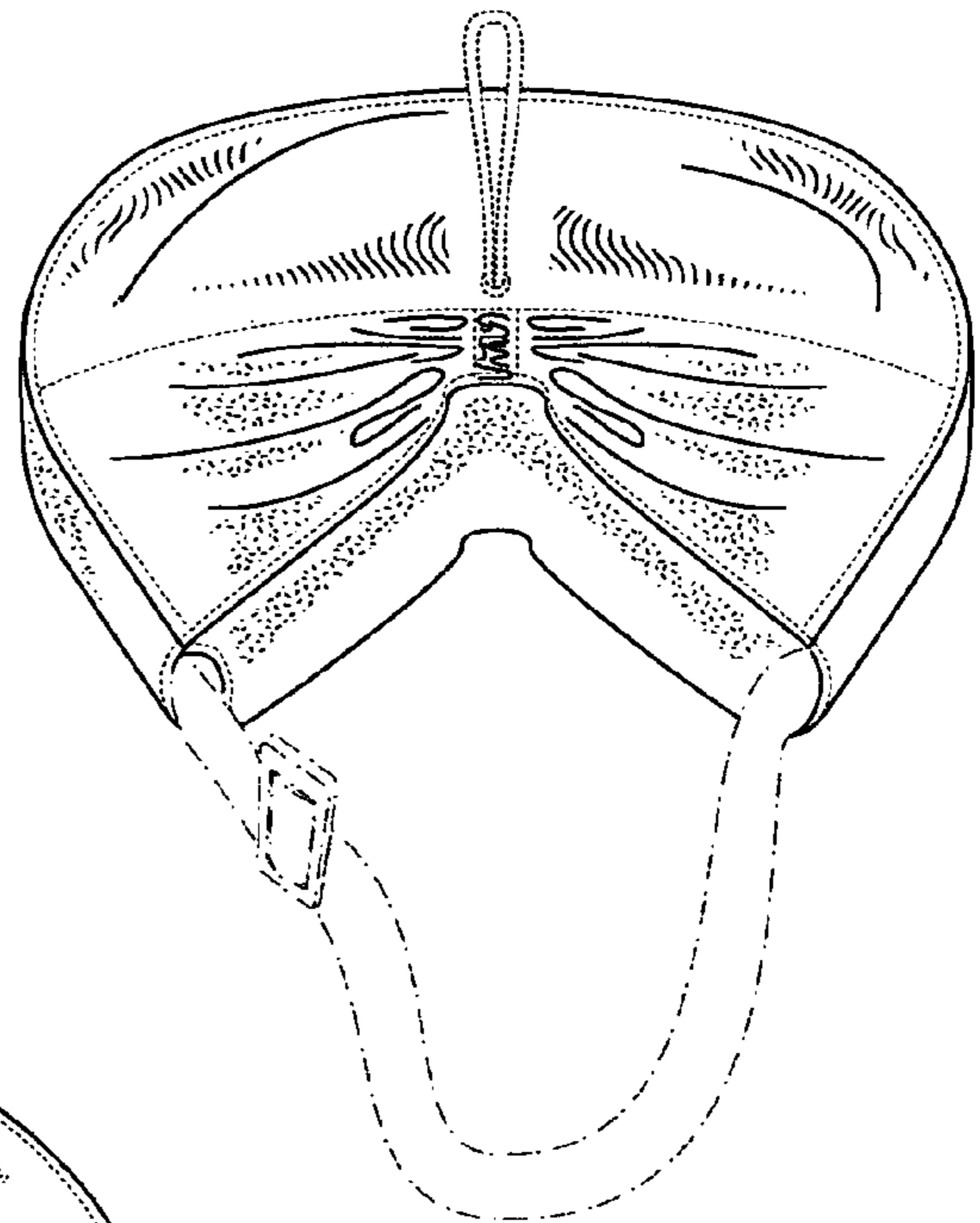

FIG. 17

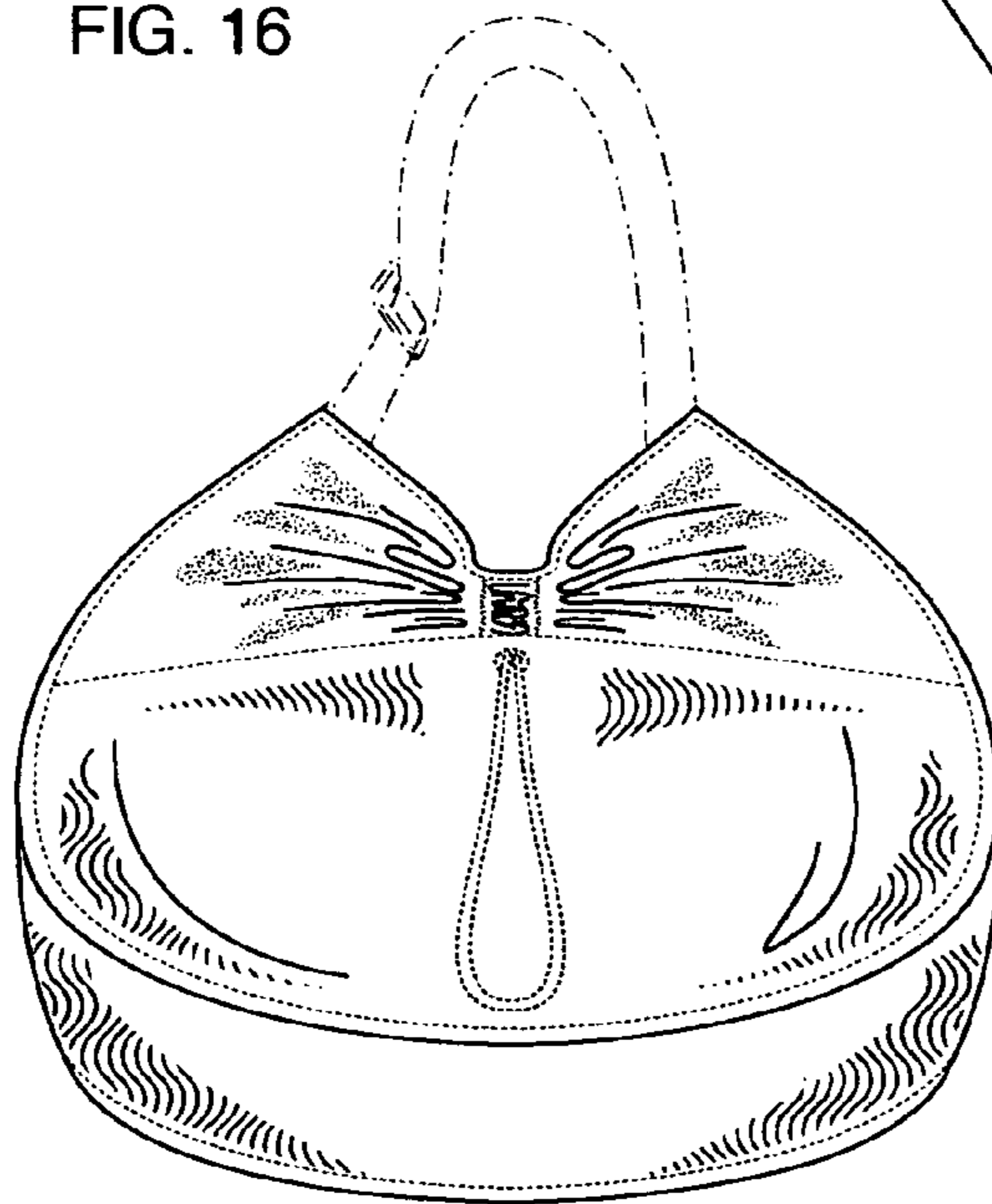

FIG. 18

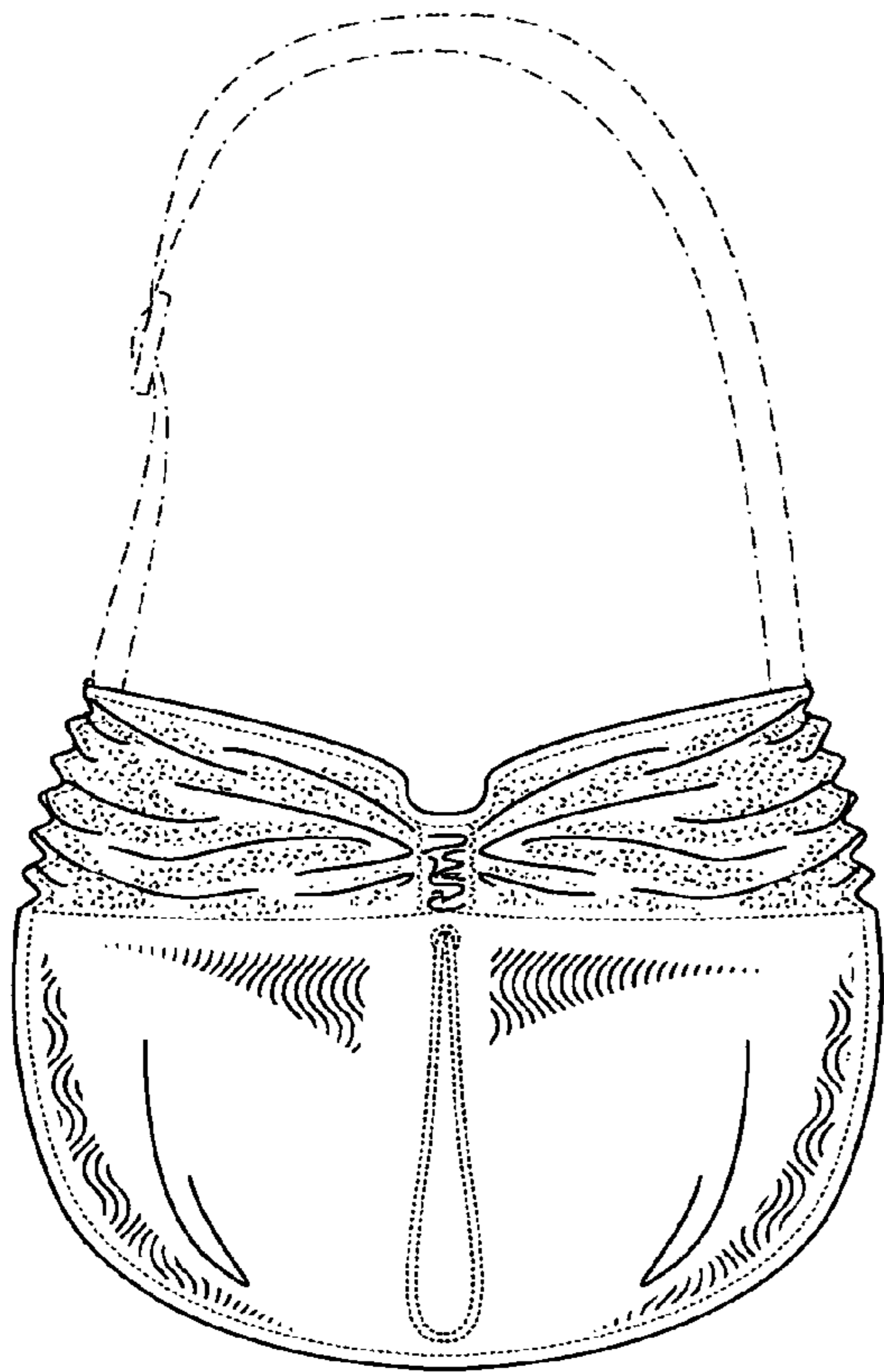

FIG. 19

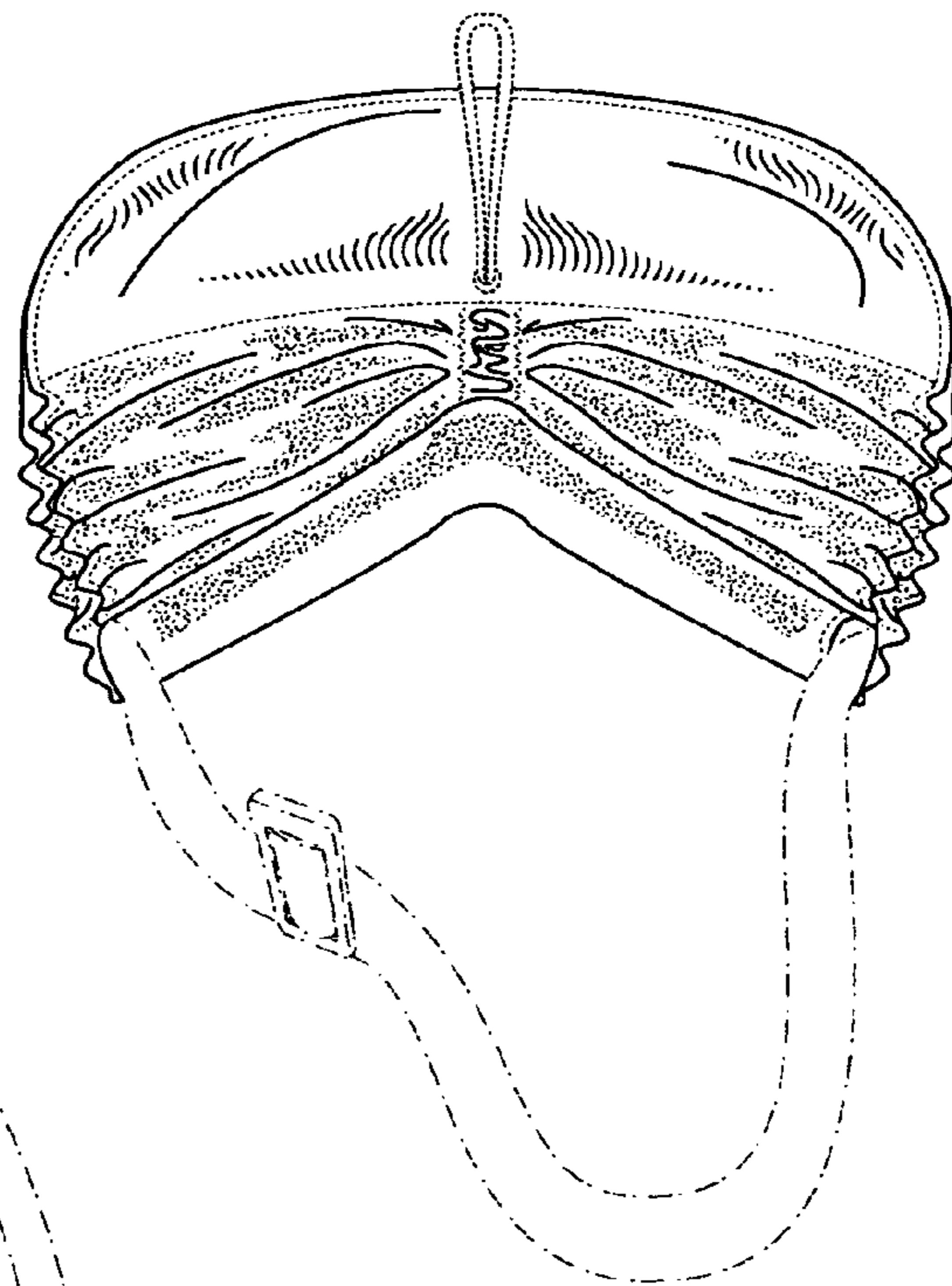

FIG. 20

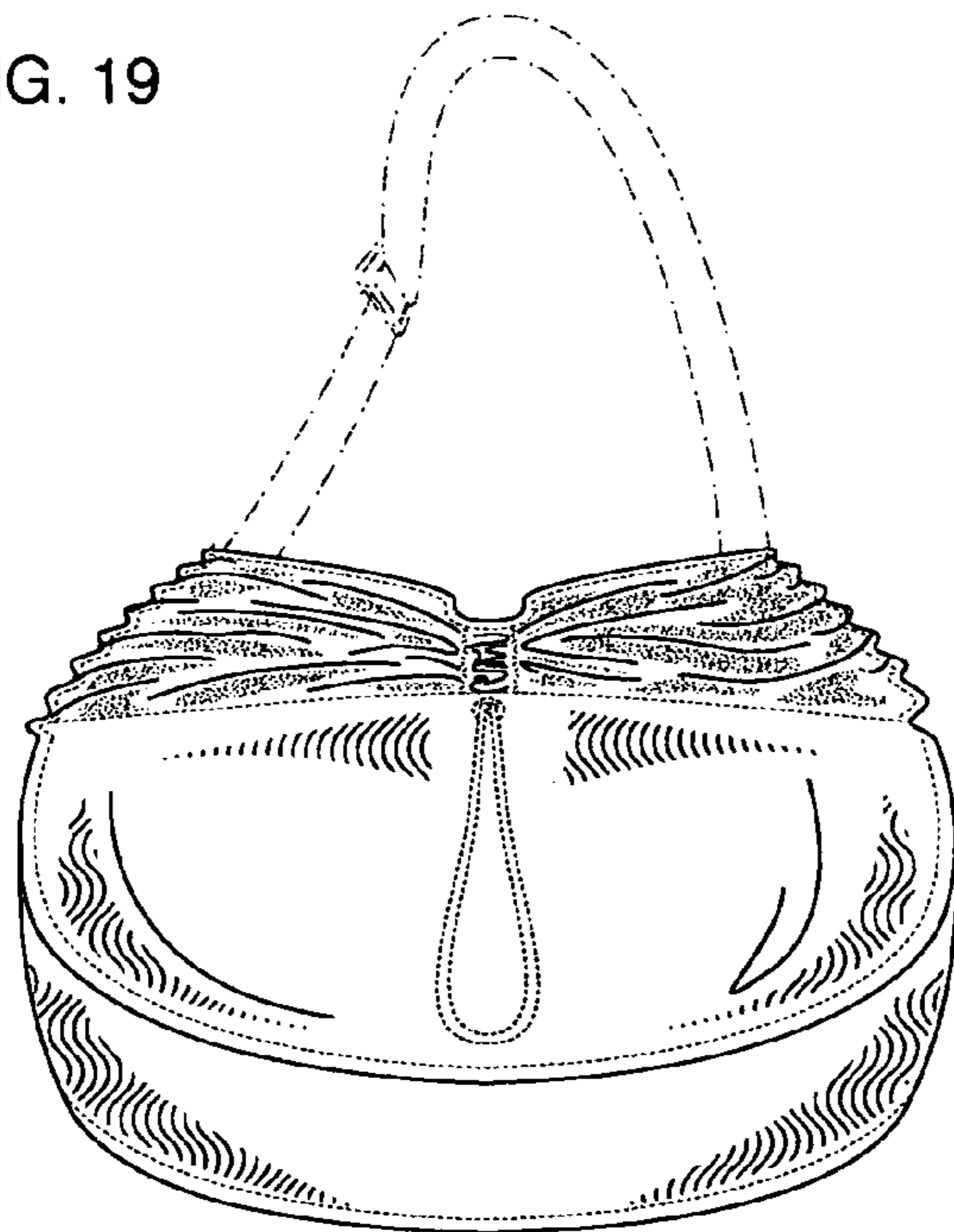

FIG. 21