



US00D611214S

(12) **United States Design Patent**  
**Kaminer et al.**

(10) **Patent No.:** **US D611,214 S**  
(45) **Date of Patent:** **\*\* Mar. 2, 2010**

(54) **TRIANGULAR SHAGGY FABRIC STEAM  
POCKET FOR A STEAM APPLIANCE**

(75) Inventors: **Brian Kaminer**, Harrison, NY (US);  
**Charles A. Boulos**, Milford, MA (US);  
**James N. Lewiecki**, Essex, MA (US);  
**Kathleen V. Jones**, Somerville, MA  
(US); **Ognjen Vrdoljak**, Laval (CA)

(73) Assignee: **Euro-Pro Operating, LLC**, Newton,  
MA (US)

(\*\*) Term: **14 Years**

(21) Appl. No.: **29/335,921**

(22) Filed: **Apr. 24, 2009**

(51) **LOC (9) Cl.** ..... **14-01**

(52) **U.S. Cl.** ..... **D32/50; D32/44**

(58) **Field of Classification Search** ..... D32/35,  
D32/40, 45, 50, 51, 30; 15/143.1, 147.1,  
15/147.2, 209.1, 210.1, 228, 231, 233; 401/137-140,  
401/15, 188 R, 268, 270, 278-279; D4/137,  
D4/115, 119

See application file for complete search history.

(56) **References Cited**

U.S. PATENT DOCUMENTS

1,420,180	A	*	6/1922	Casmire	.....	15/229.4
1,643,637	A	*	9/1927	Chadwick	.....	15/228
D245,473	S	*	8/1977	Heninger	.....	D32/50
D384,209	S	*	9/1997	Driggers	.....	D4/137
D460,232	S	*	7/2002	Weihrauch	.....	D32/50
D471,334	S	*	3/2003	Reede	.....	D32/50
D536,176	S	*	2/2007	Ramirez	.....	D4/115

D544,667	S	*	6/2007	Nelson et al.	.....	D32/50
D547,069	S	*	7/2007	Braithwaite et al.	.....	D4/137
D549,415	S	*	8/2007	Trotter et al.	.....	D32/50
D592,406	S	*	5/2009	Gallardo	.....	D4/119
7,540,056	B2	*	6/2009	Dotterman et al.	.....	15/228
D599,518	S	*	9/2009	Vrdoljak	.....	D32/40

\* cited by examiner

*Primary Examiner*—Cathron C Brooks

*Assistant Examiner*—Austin Murphy

(74) *Attorney, Agent, or Firm*—McCarter & English, LLP;  
Michael I. Wolfson

(57) **CLAIM**

The ornamental design for a triangular shaggy fabric steam pocket for a steam appliance, as shown and described.

**DESCRIPTION**

FIG. 1 is a top perspective view of a triangular shaggy fabric steam pocket for a steam appliance showing our new design;

FIG. 2 is a top plan view thereof;

FIG. 3 is a bottom plan view thereof;

FIG. 4 is a rear elevational view thereof;

FIG. 5 is a front elevational view thereof;

FIG. 6 is a right side view thereof;

FIG. 7 is a left side view thereof; and,

FIG. 8 is a front perspective view of the triangular shaggy fabric steam pocket of FIG. 1 installed on a steam mop.

The broken lines shown in the drawings represent environmental structure and form no part of the claimed design.

**1 Claim, 7 Drawing Sheets**

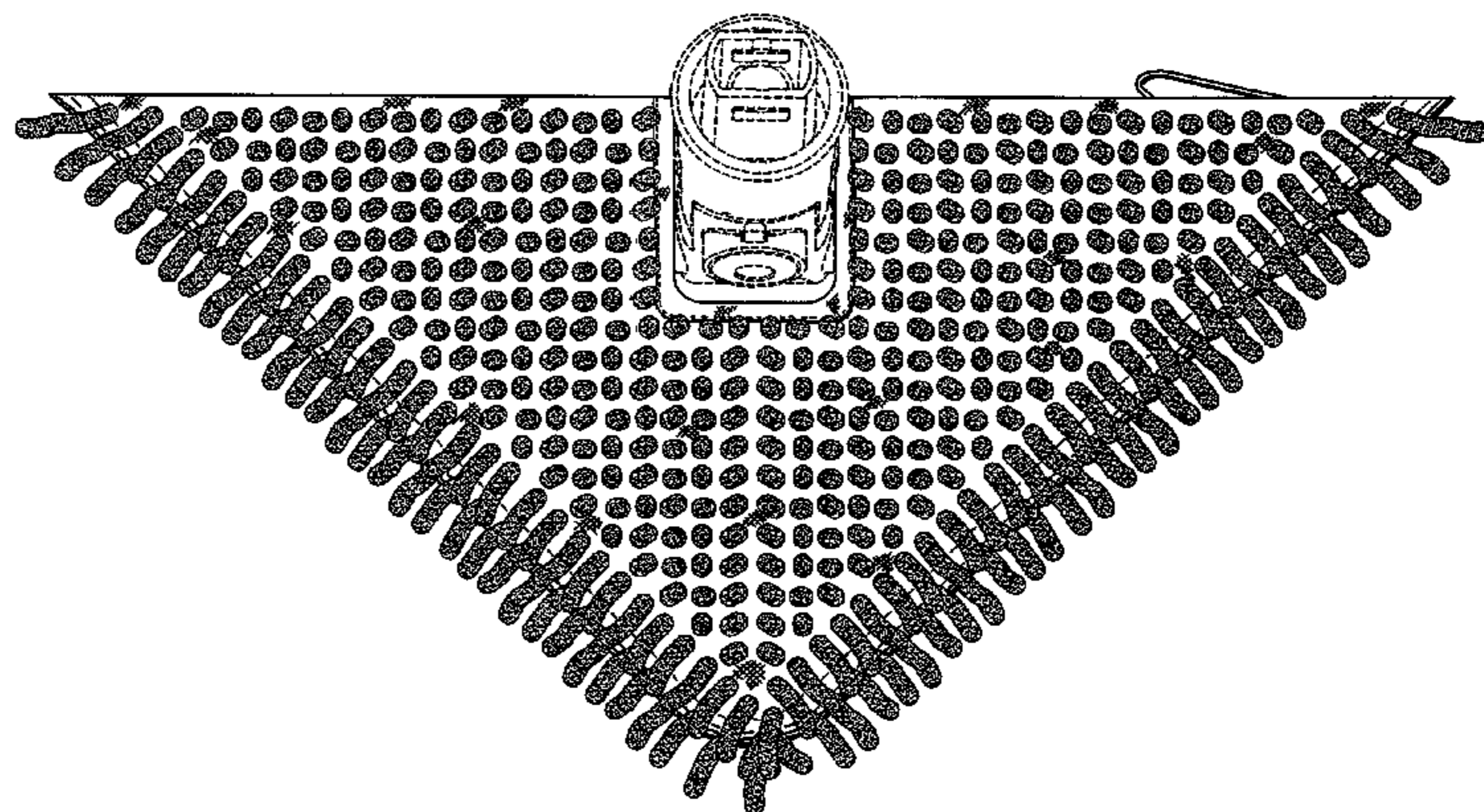
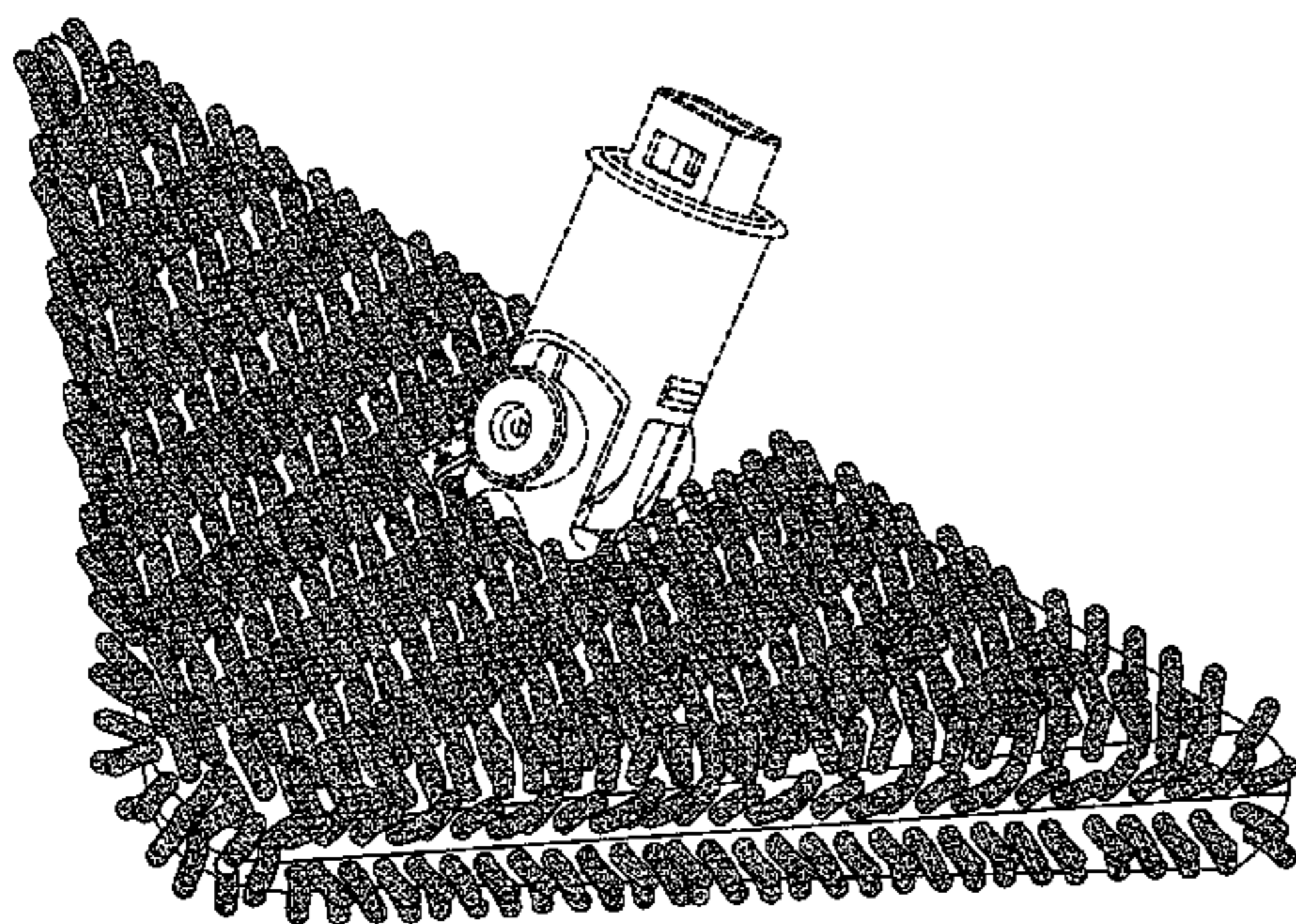



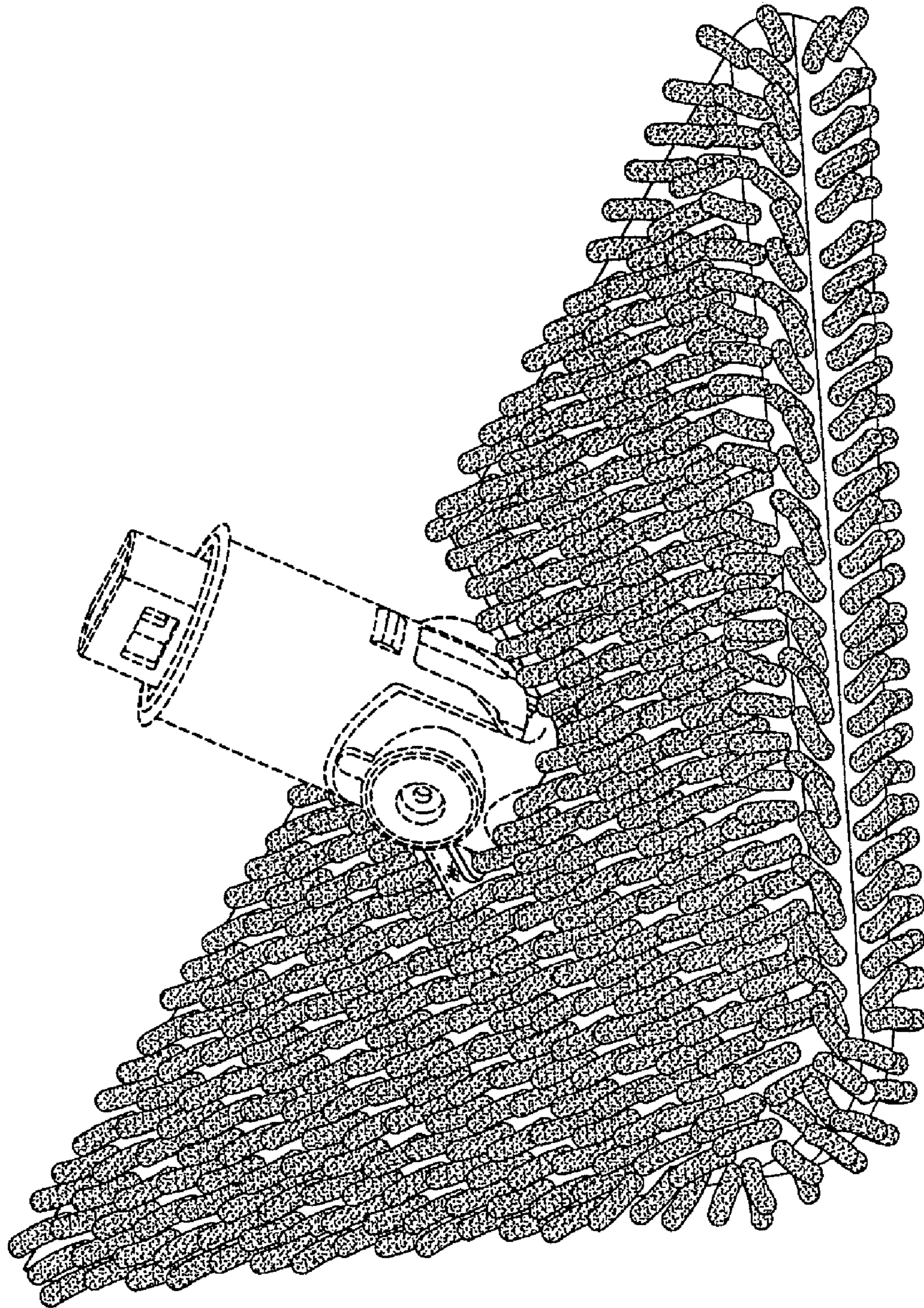

FIG.1



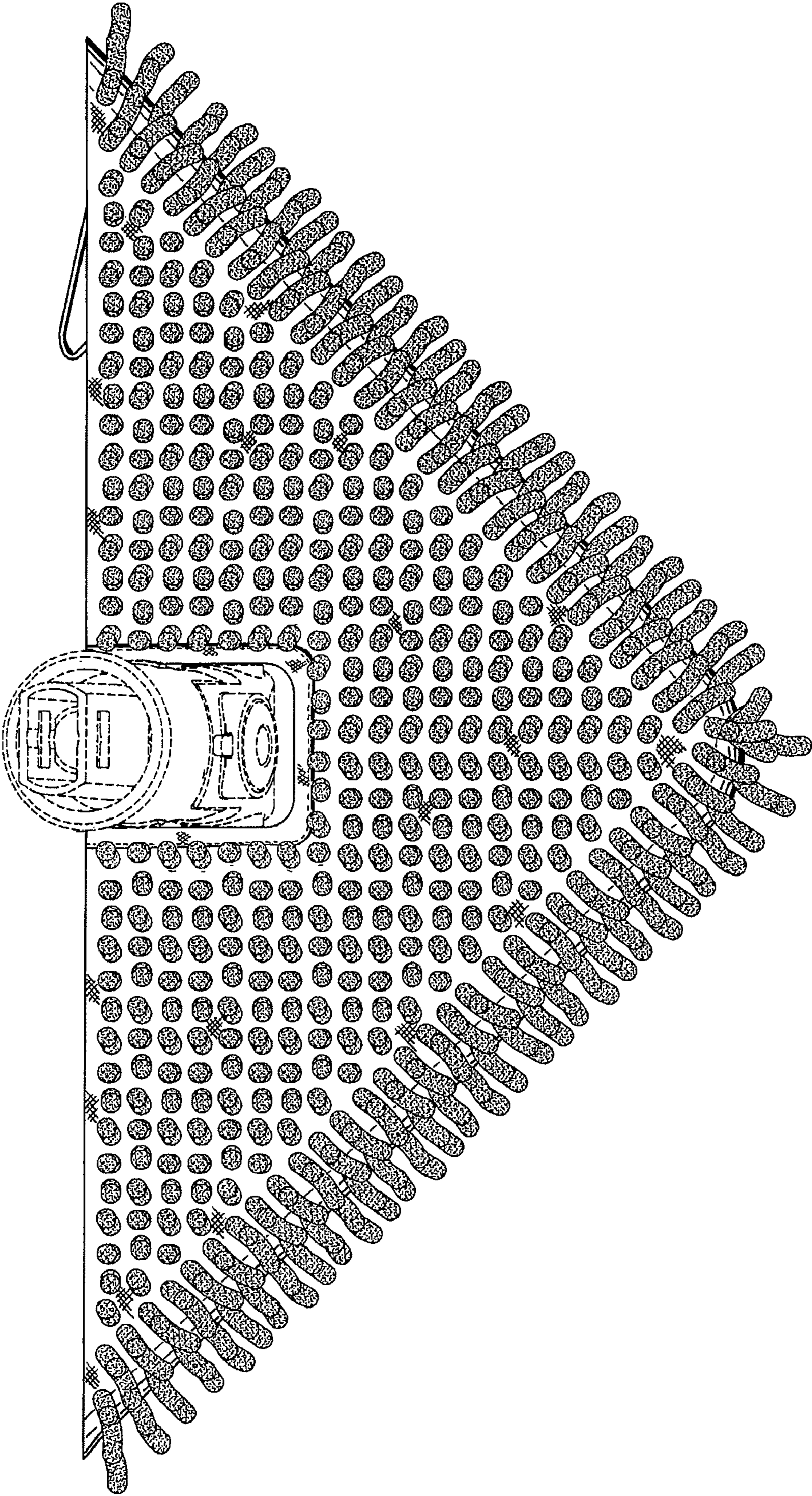

FIG.2



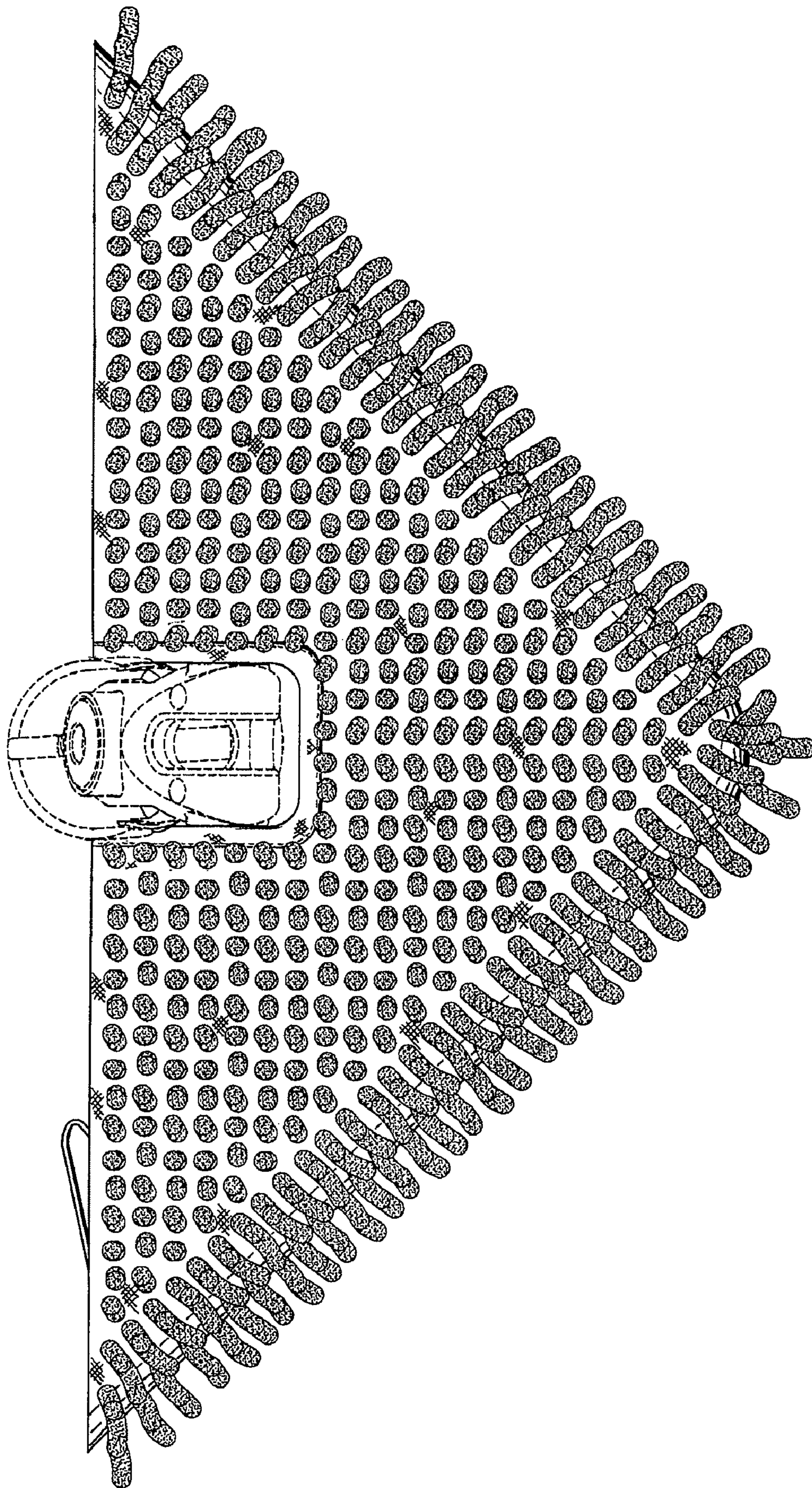

FIG. 3



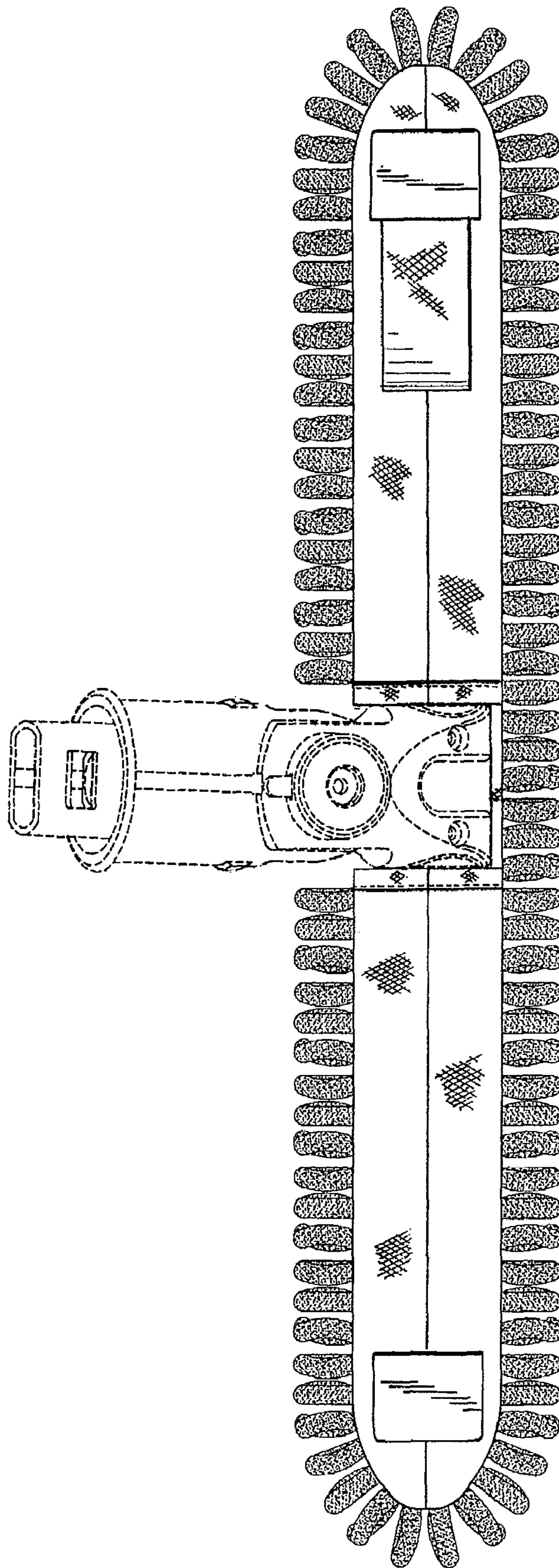

FIG.4

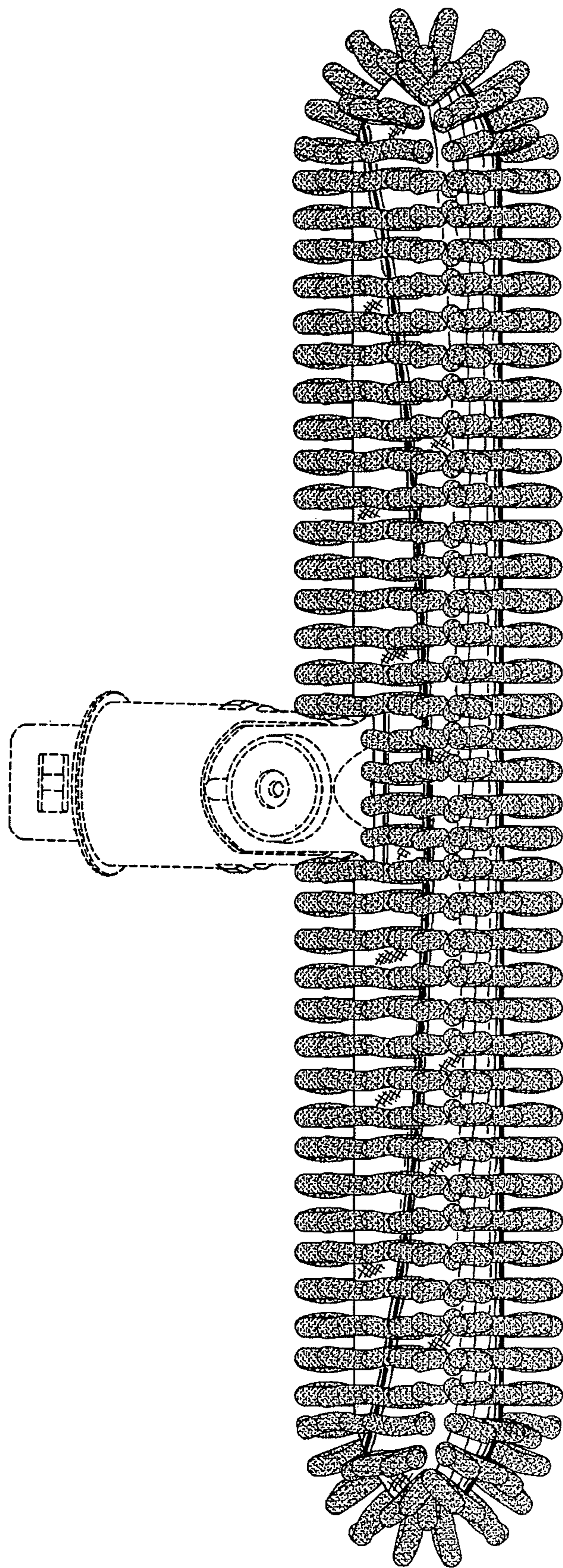

FIG. 5



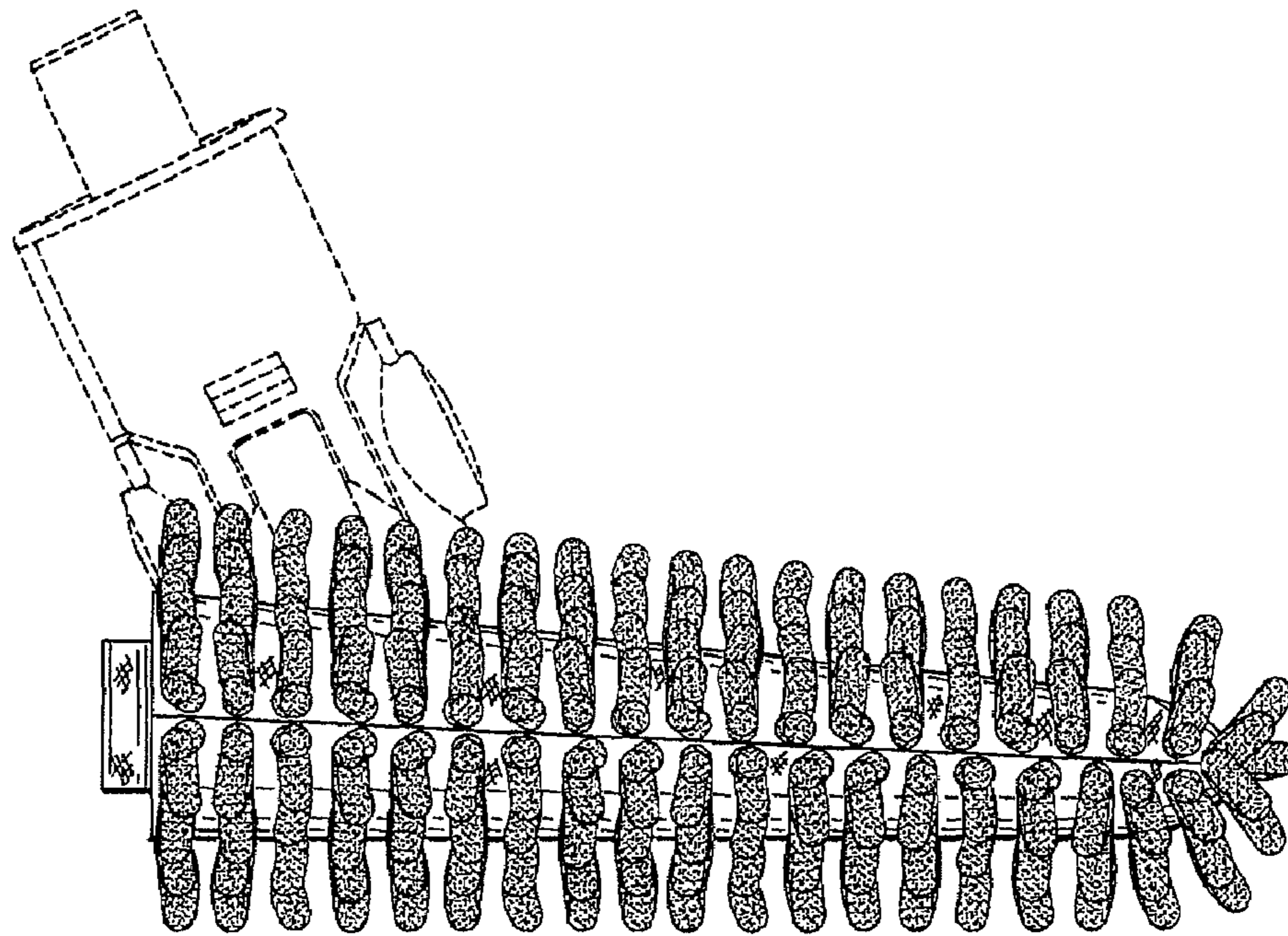

FIG. 6

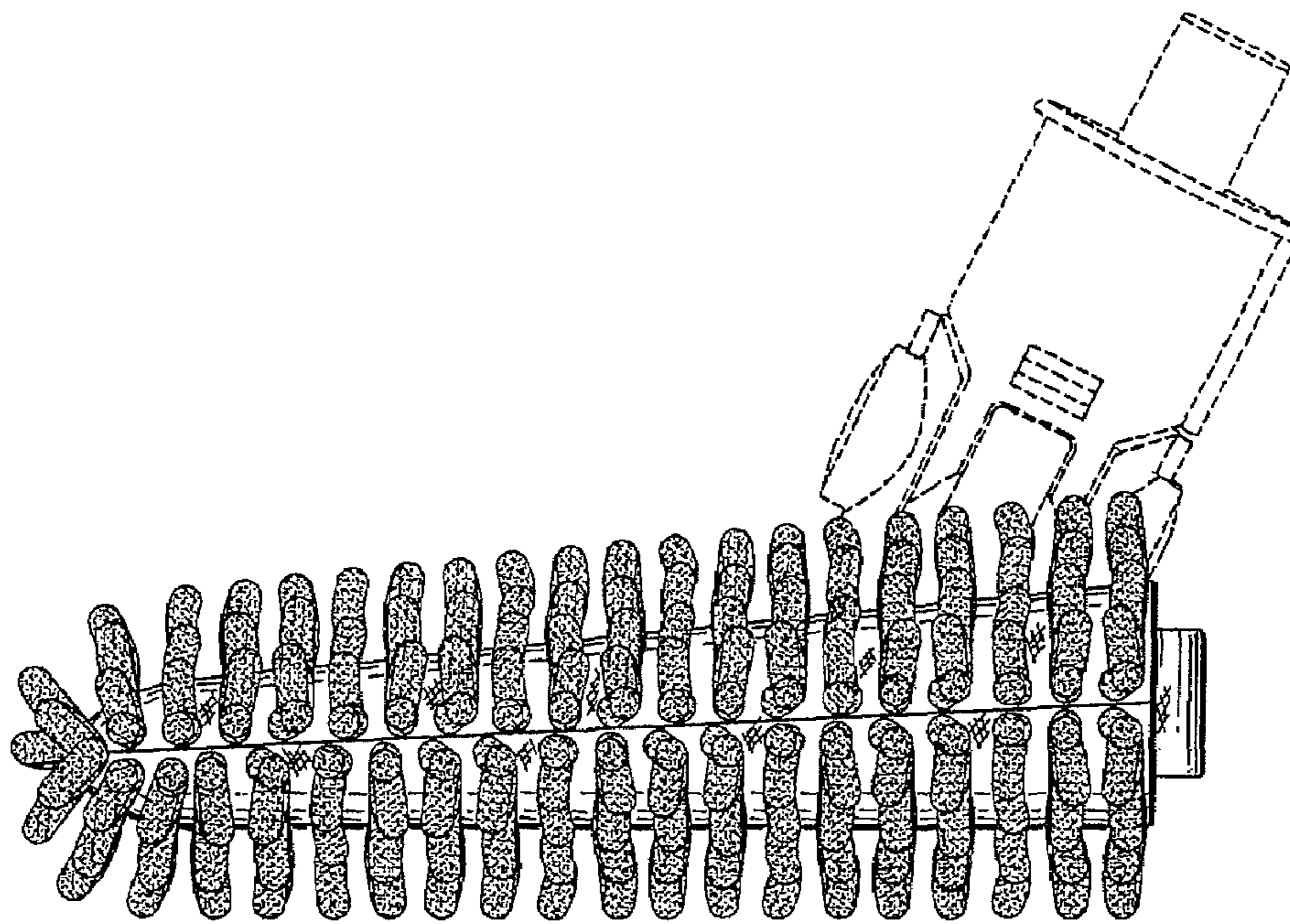

FIG. 7

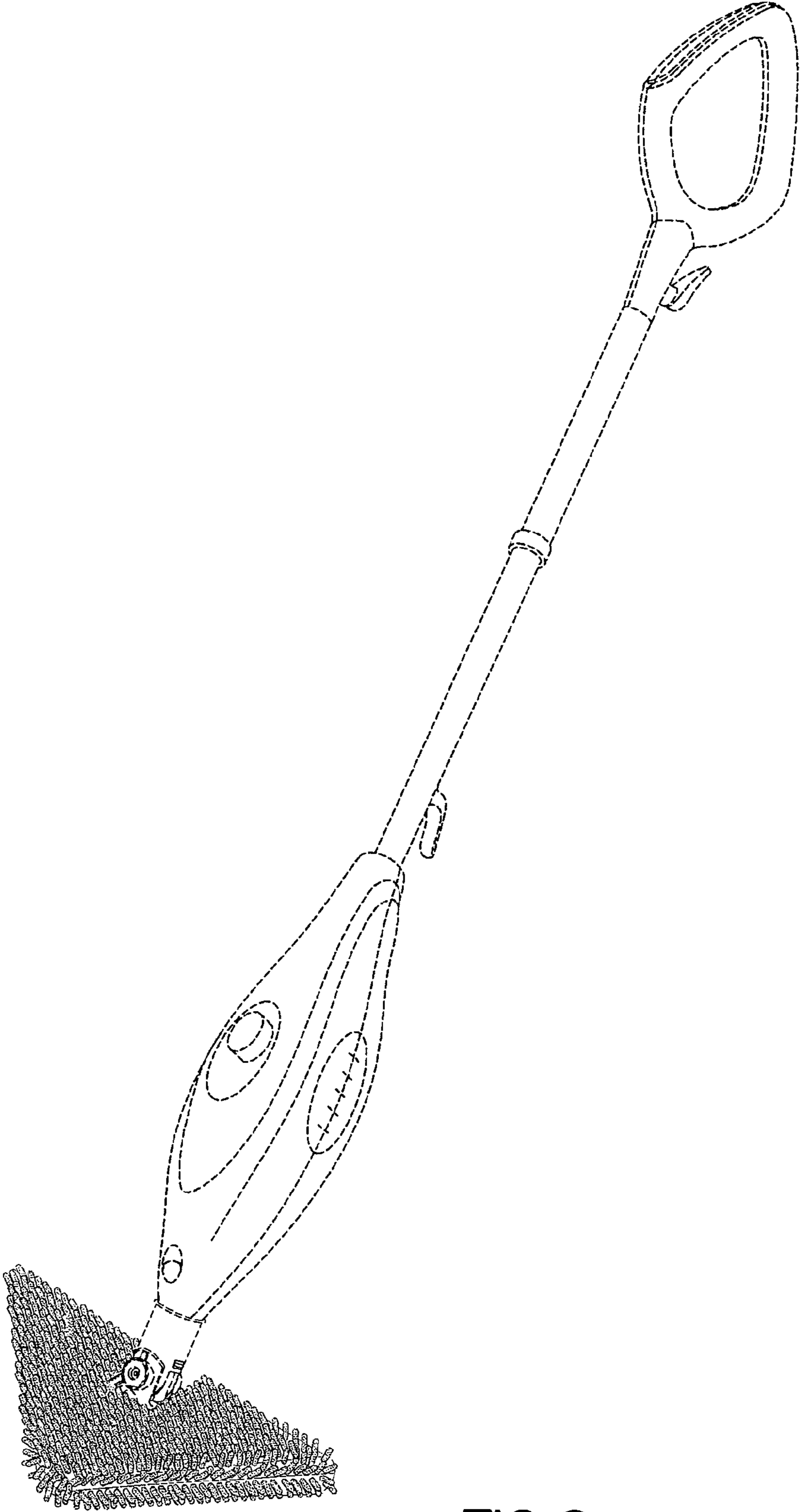

FIG.8