



US00D611195S

(12) **United States Design Patent**  
**Gieux**

(10) **Patent No.:** **US D611,195 S**  
(45) **Date of Patent:** **\*\* Mar. 2, 2010**

(54) **HAIR MARKER**

D531,753 S \* 11/2006 Davis et al. .... D28/20

(75) Inventor: **Gerard Gieux**, Paris (FR)

\* cited by examiner

(73) Assignee: **Figie S.A.**, GD de Luxembourg (BE)

*Primary Examiner*—Janice E Seeger

*Assistant Examiner*—Zenia I Bennett

(\*\*) Term: **14 Years**

(74) *Attorney, Agent, or Firm*—Young & Thompson

(21) Appl. No.: **29/295,468**

(57) **CLAIM**

(22) Filed: **Sep. 28, 2007**

The ornamental design for a hair marker, as shown and described.

(30) **Foreign Application Priority Data**

**DESCRIPTION**

Apr. 10, 2007 (EM) ..... 000704275-0001

(51) **LOC (9) Cl.** ..... **28-03**

FIG. 1 is a top and side perspective view of a hair marker showing my new design, with the cap on;

(52) **U.S. Cl.** ..... **D28/7**

FIG. 2 is a side elevational view thereof;

(58) **Field of Classification Search** ..... D28/7,  
D28/8, 20–22, 30–31, 99; 132/108, 202,  
132/208, 317, 320; D9/723–726

FIG. 3 is a side elevational view thereof from the side opposite that shown in FIG. 2;

See application file for complete search history.

FIG. 4 is a top plan view thereof;

(56) **References Cited**

FIG. 5 is a bottom plan view thereof;

**U.S. PATENT DOCUMENTS**

FIG. 6 is a side elevational view rotated 90 degrees from the position shown in FIG. 2;

D184,445 S \* 2/1959 Lerner ..... D9/436

FIG. 7 is a side elevational view thereof showing the side opposite that shown in FIG. 6;

5,311,887 A \* 5/1994 Ramsey ..... 132/114

FIGS. 8–14 are views similar to FIGS. 1–7, respectively, but with the cap off; and,

D401,380 S \* 11/1998 Steen et al. .... D28/7

FIG. 15 is a view similar to FIG. 8 but showing the side opposite that shown in FIG. 8.

D442,331 S \* 5/2001 Pannozzo et al. .... D28/7

The material shown in broken line forms no part of the claimed design.

D450,153 S \* 11/2001 Knieriemen ..... D28/7

D450,884 S \* 11/2001 Yoshida ..... D28/20

D451,244 S \* 11/2001 Chen et al. .... D28/25

D474,561 S \* 5/2003 Glucksman et al. .... D28/7

D488,256 S \* 4/2004 Vena et al. .... D28/7

D493,914 S \* 8/2004 Vena et al. .... D28/7

D519,674 S \* 4/2006 Chu et al. .... D28/7

D519,675 S \* 4/2006 Armstrong ..... D28/7

**1 Claim, 7 Drawing Sheets**

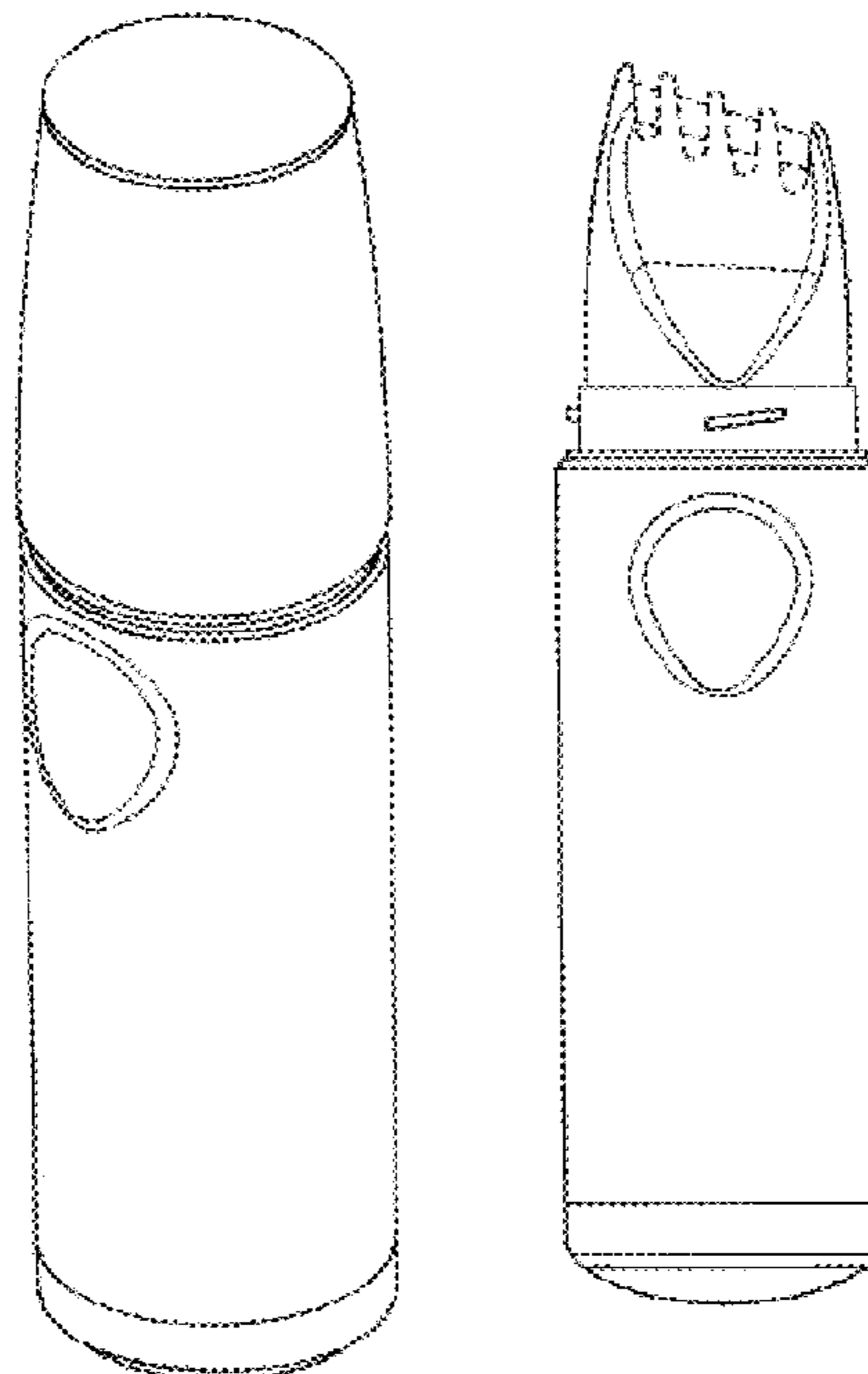

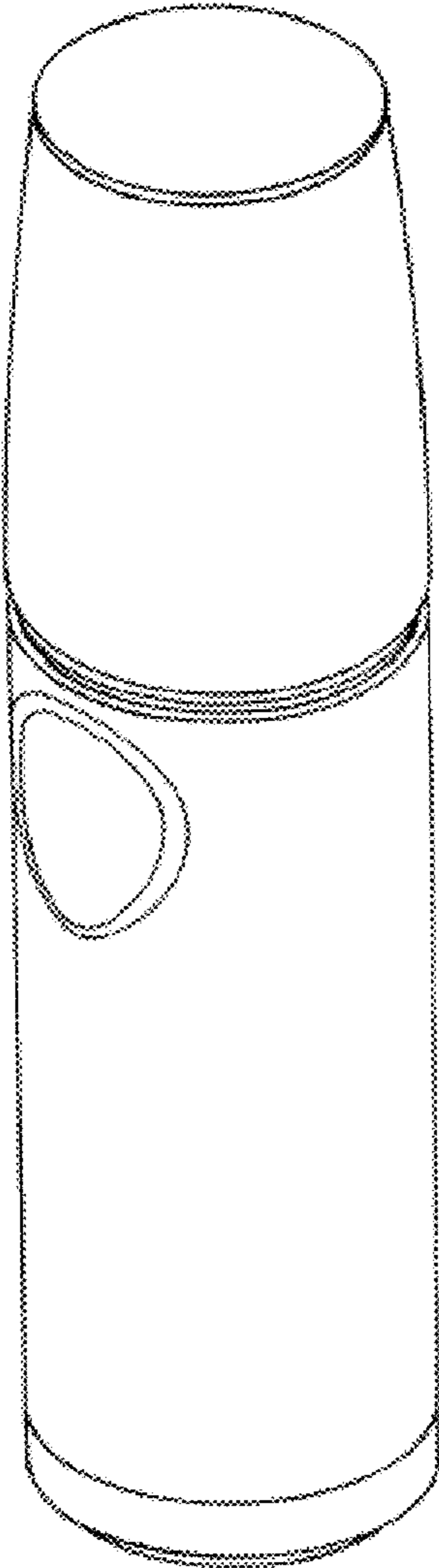

FIG. 1

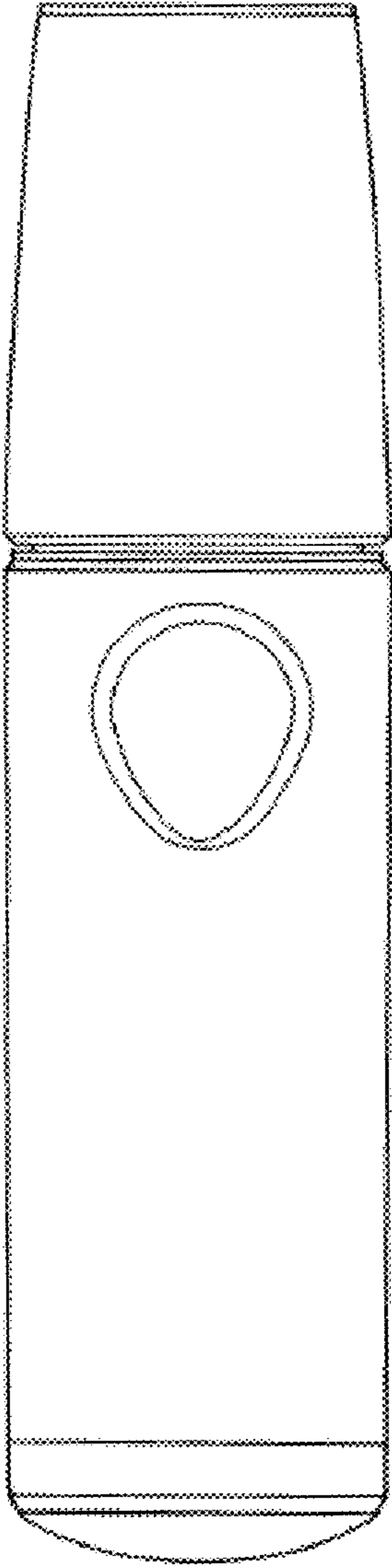

FIG. 2

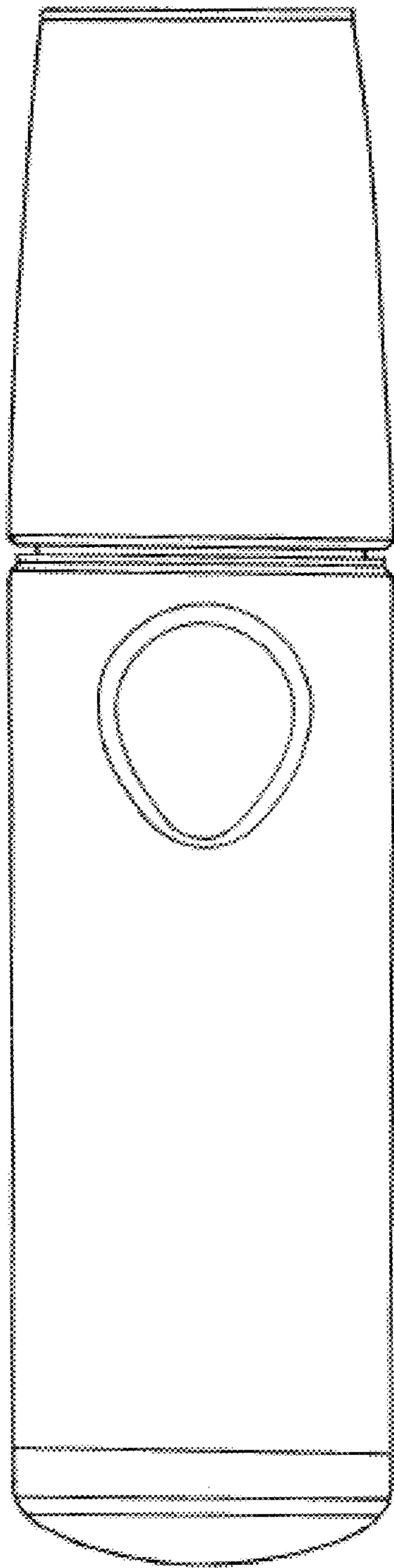

FIG. 3

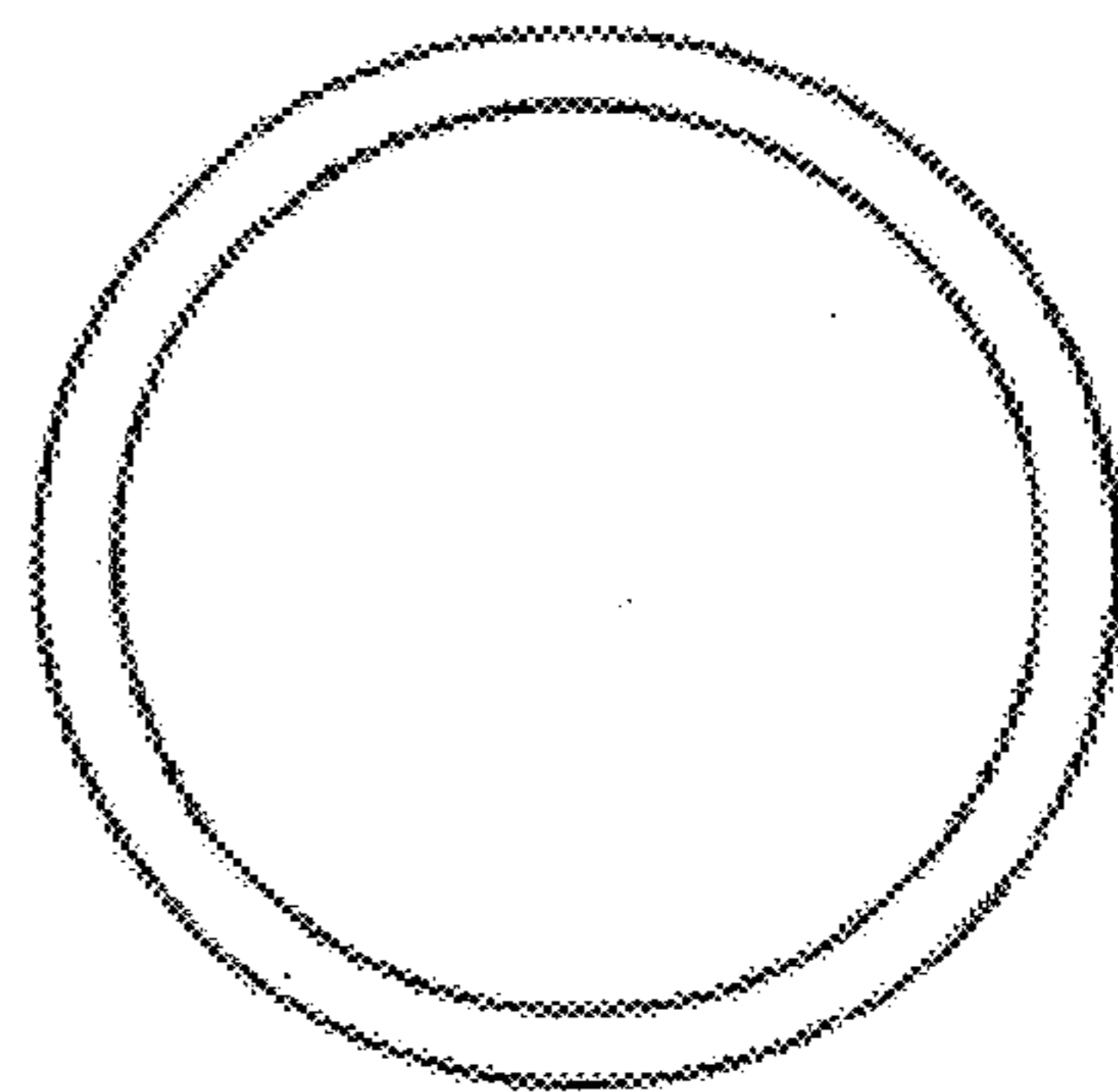
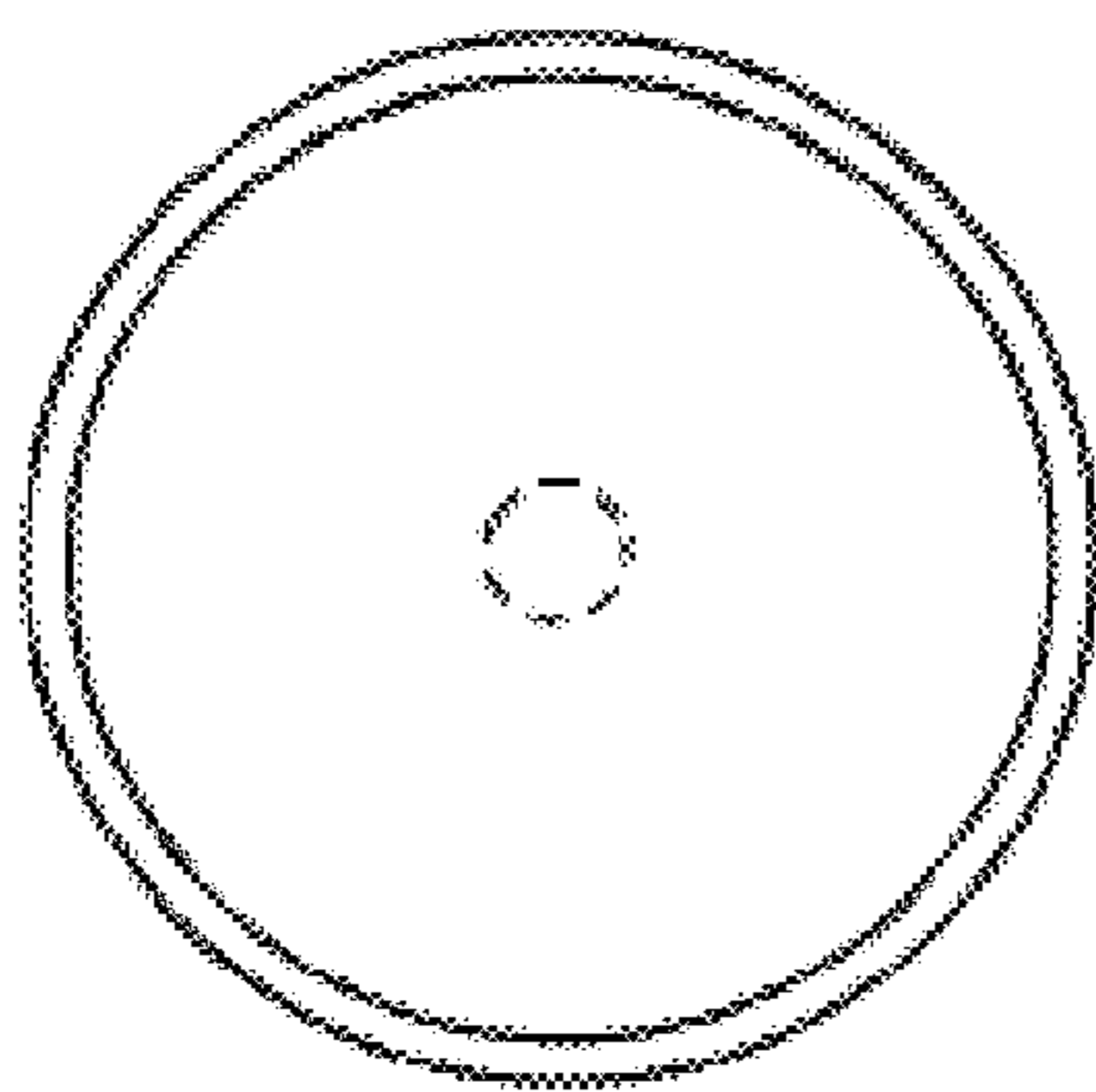
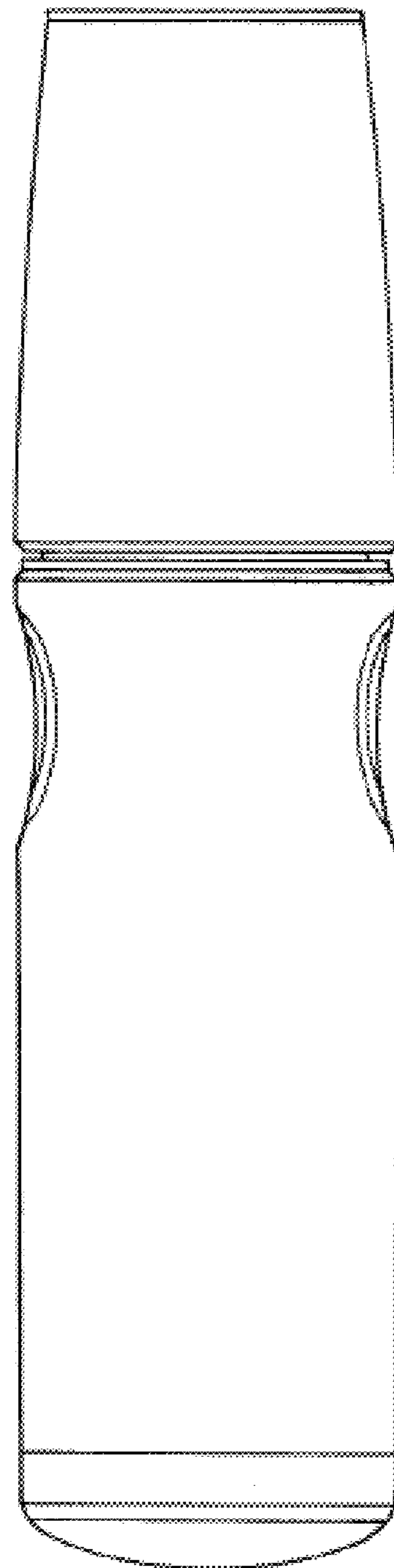

FIG. 4



**FIG. 5**



**FIG. 6**

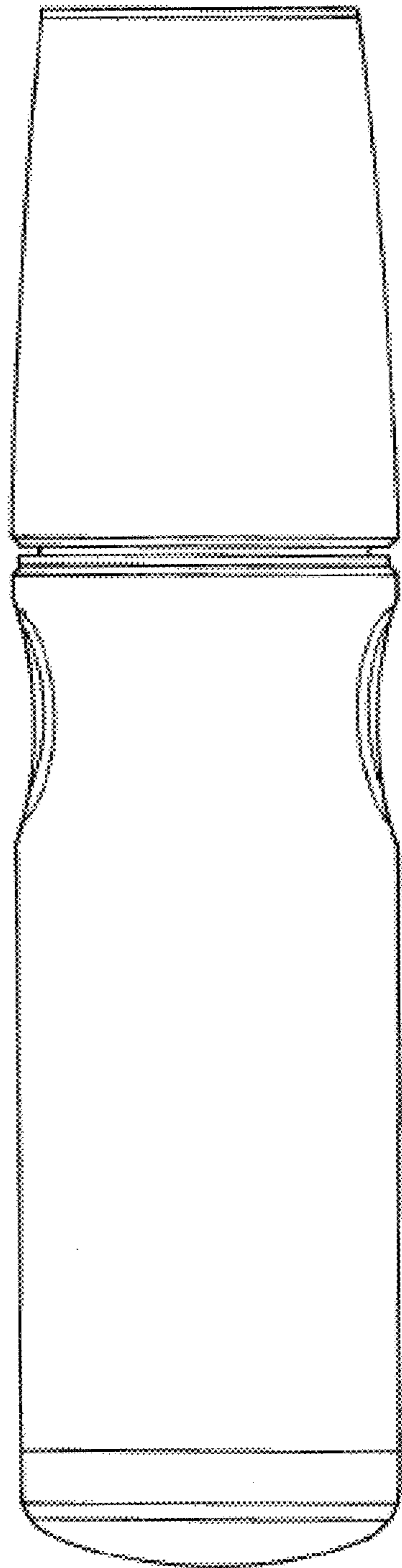

**FIG. 7**

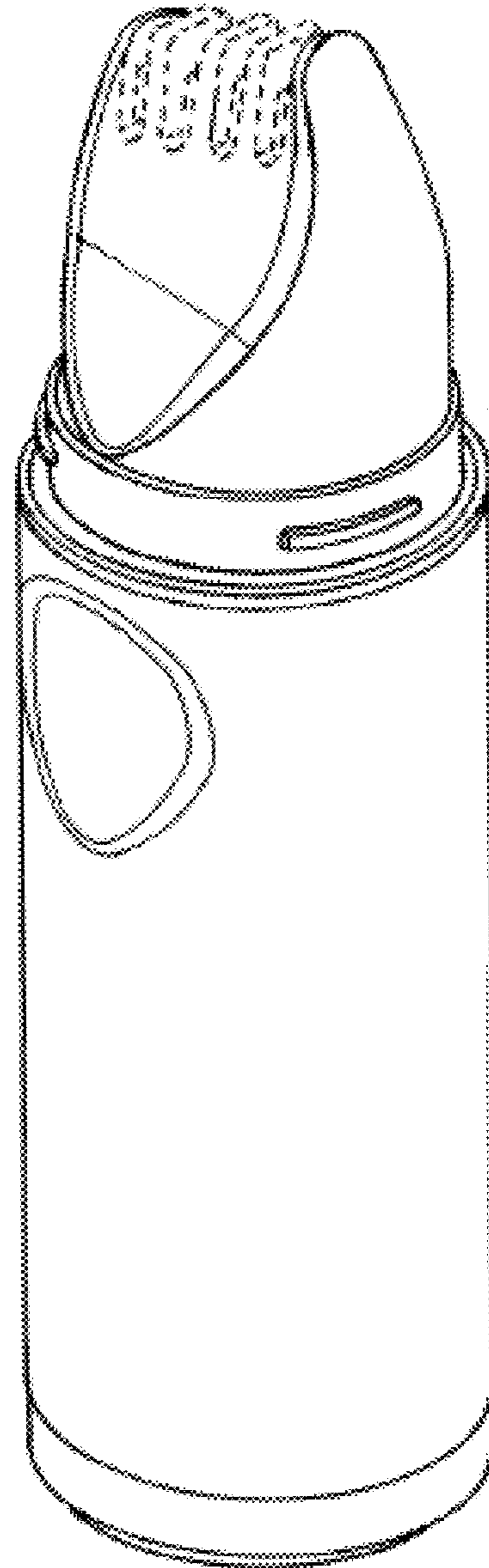

**FIG. 8**

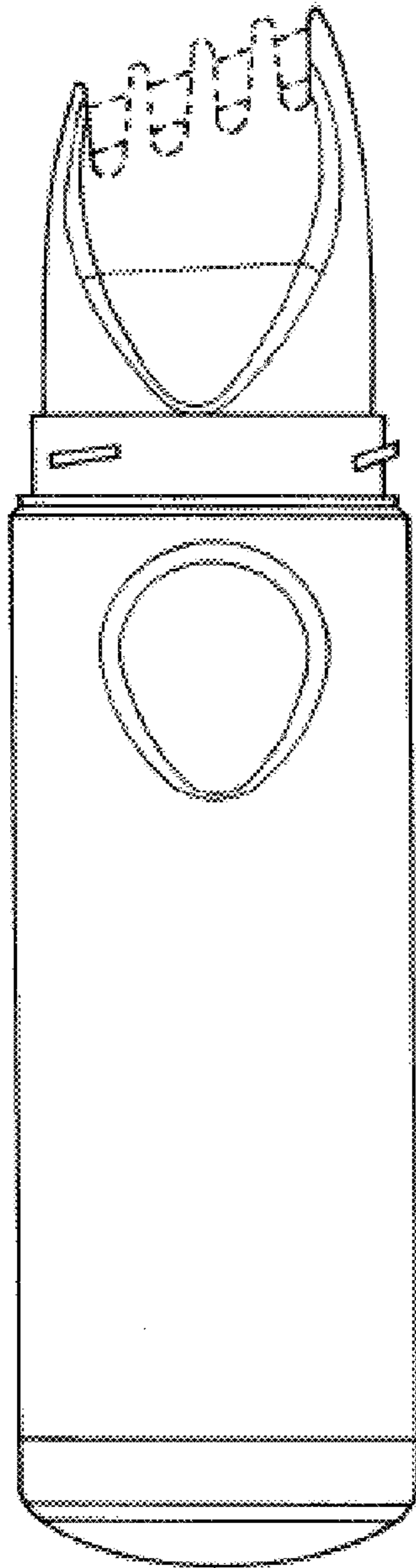

FIG. 9

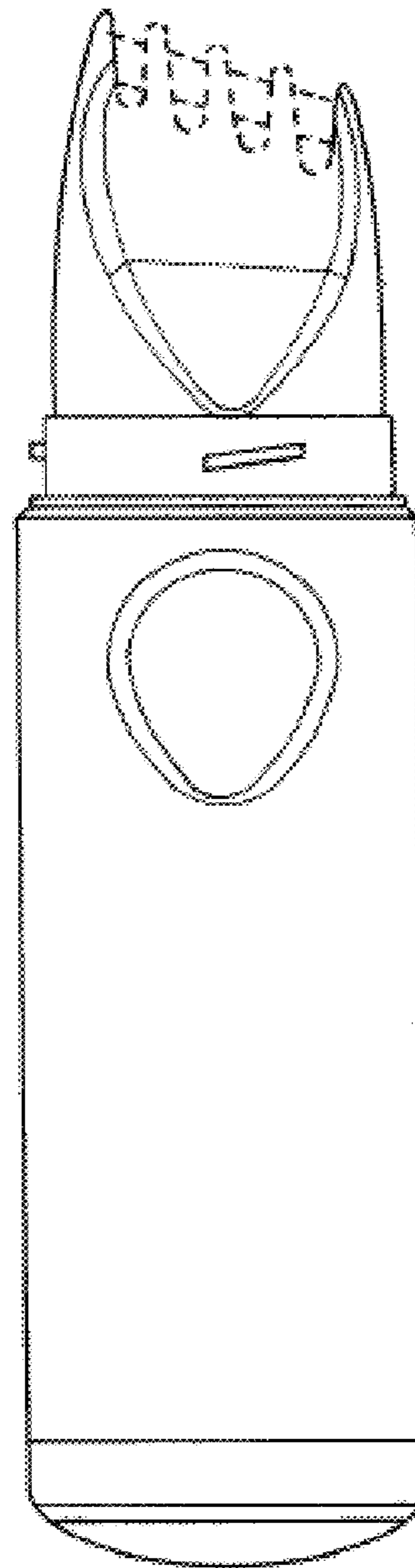
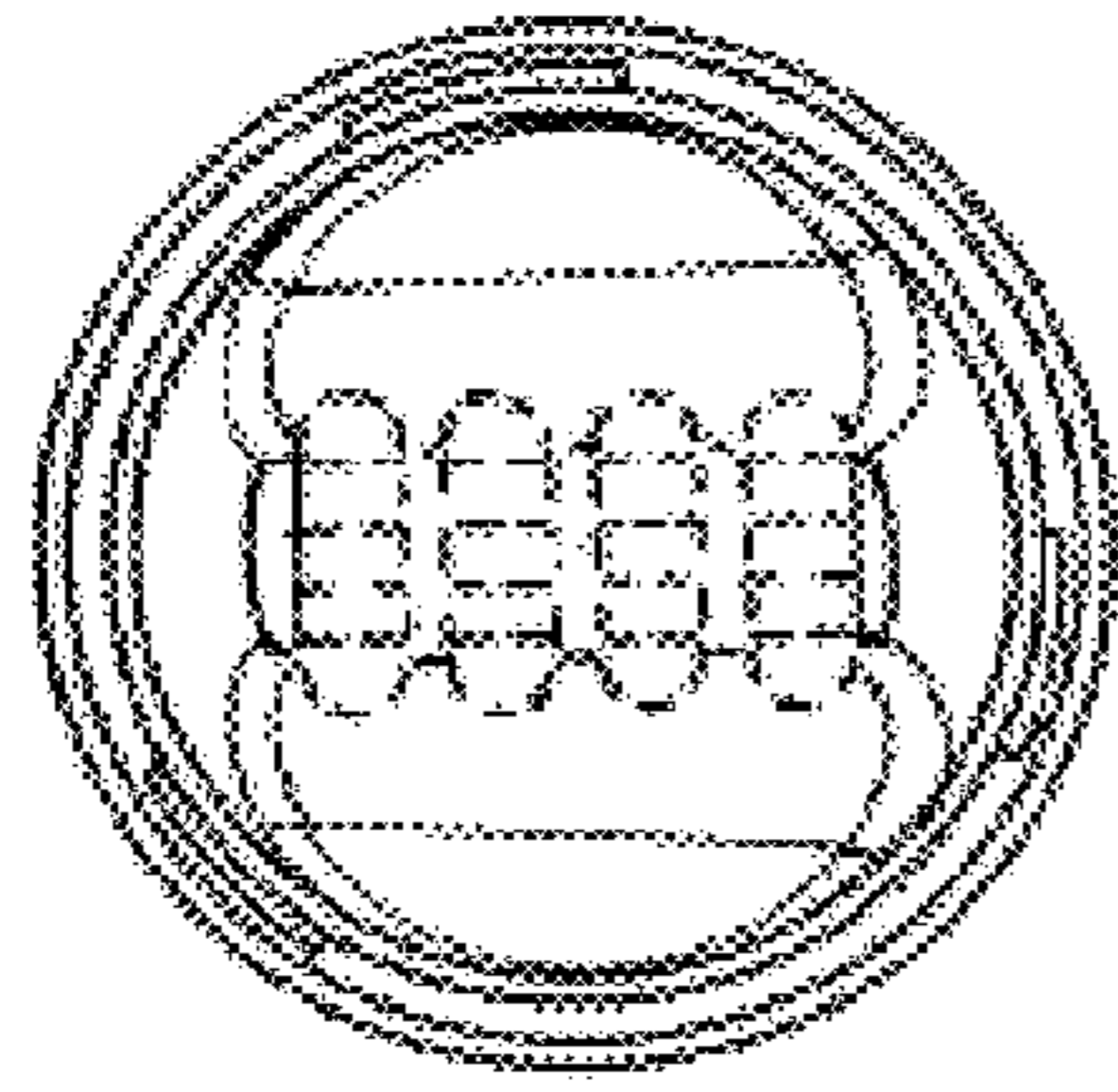
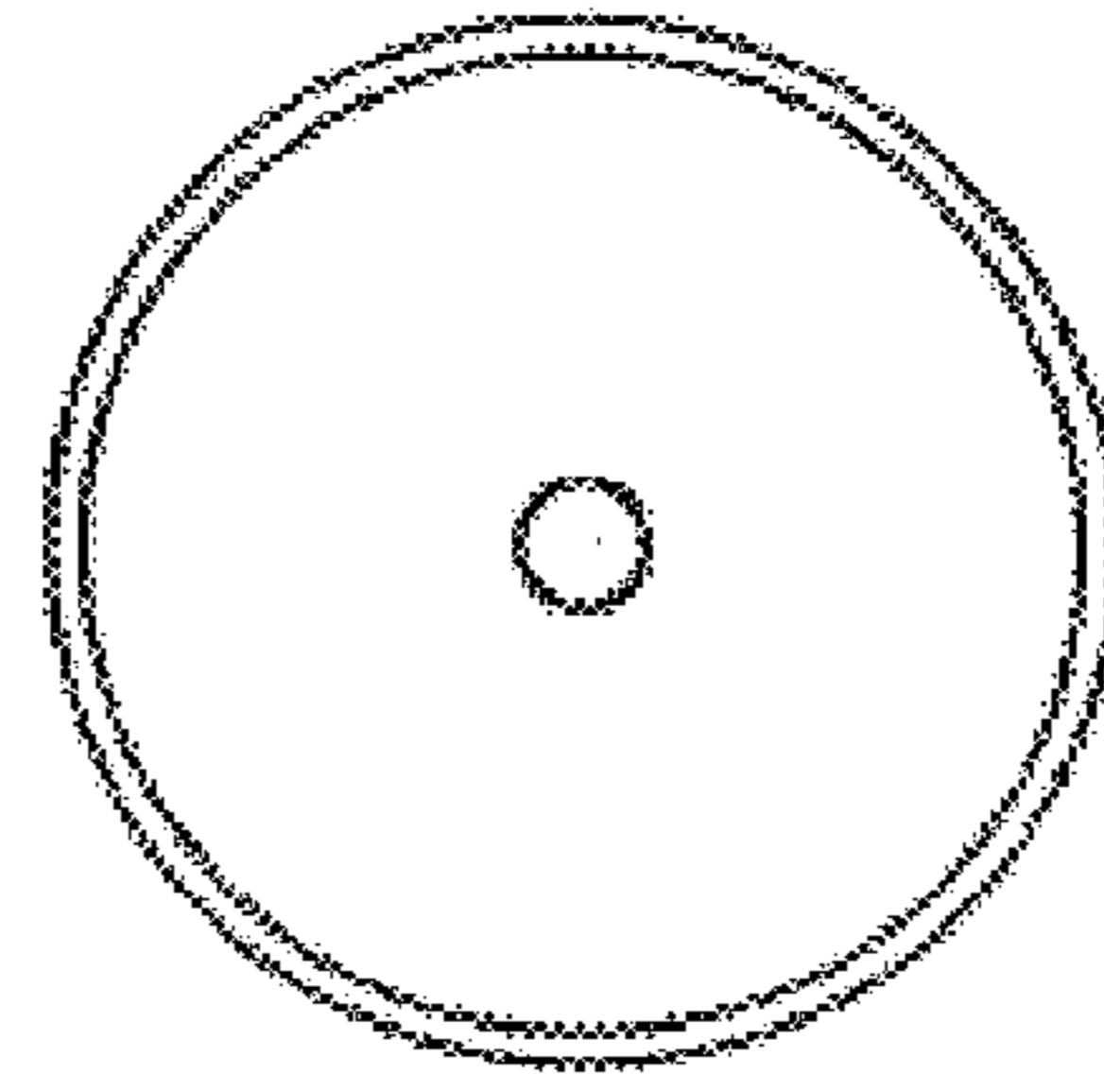

FIG. 10



**FIG. 11**



**FIG. 12**

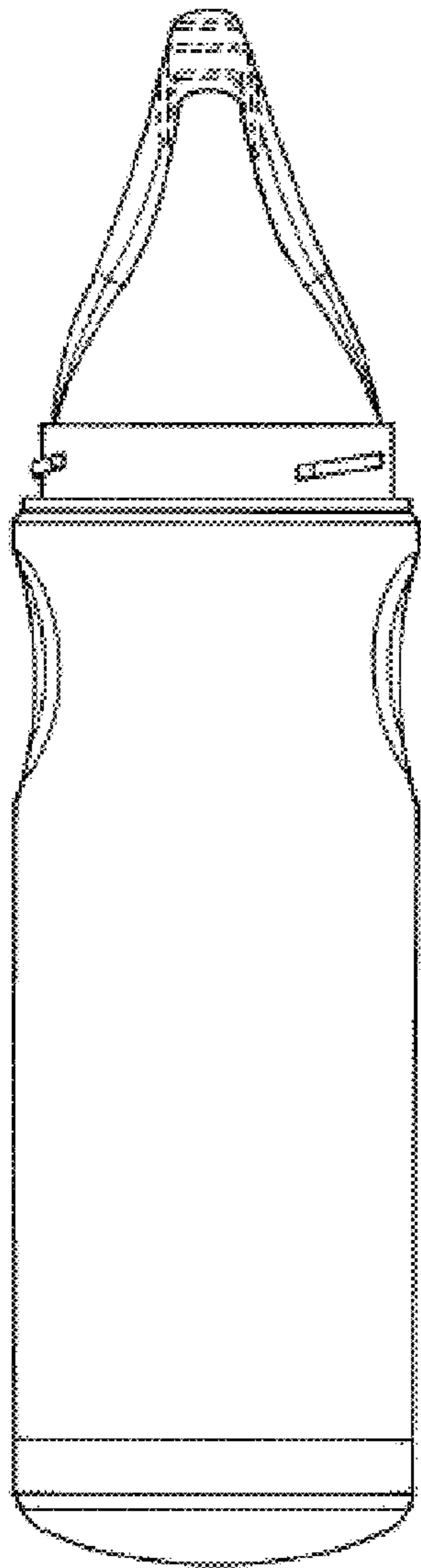

**FIG. 13**

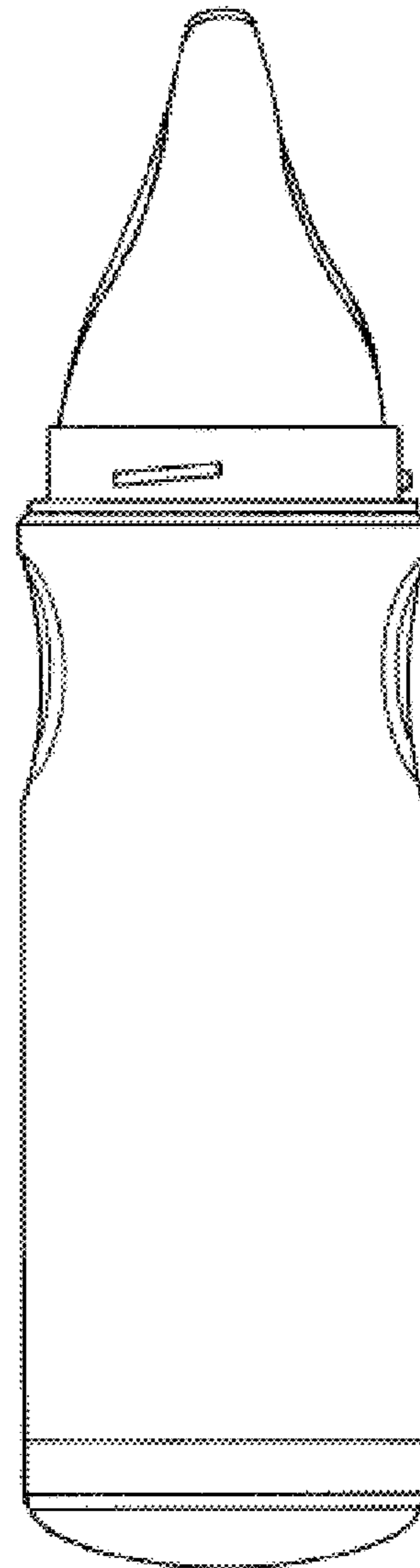

**FIG. 14**

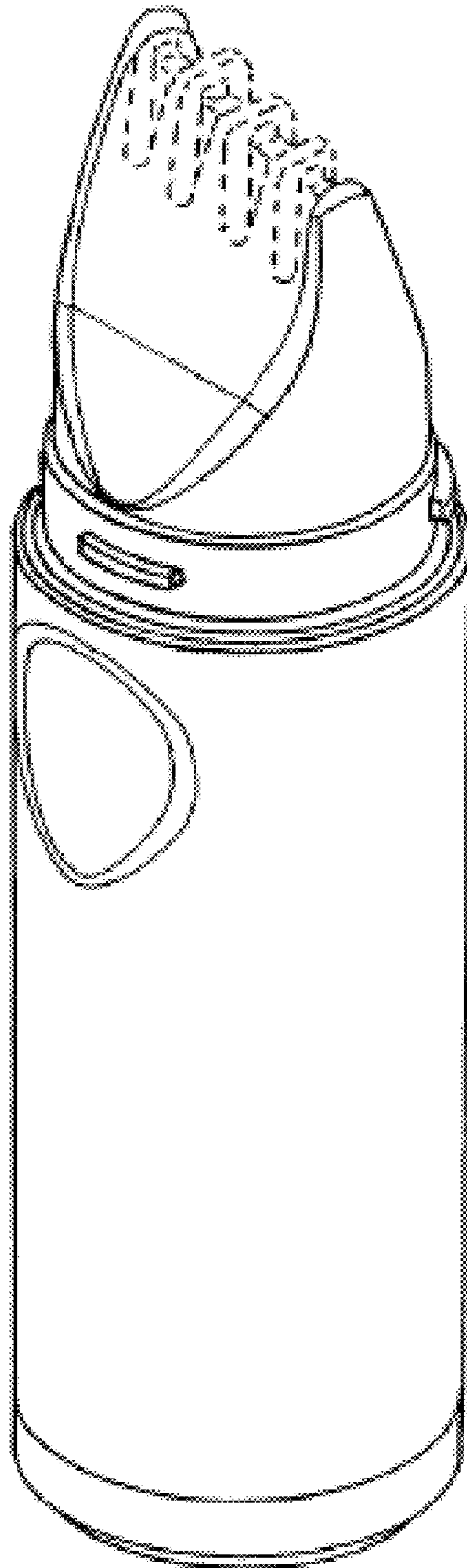

**FIG. 15**