



US00D611141S

(12) **United States Design Patent**
Yodfat et al.

(10) **Patent No.:** **US D611,141 S**
(45) **Date of Patent:** **** Mar. 2, 2010**

(54) **PROTECTOR FOR USE WITH INFUSION PUMPS**

(75) Inventors: **Ofer Yodfat**, Maccabim-Reut (IL);
Avraham Neta, D.N. Misgav (IL)

(73) Assignee: **Medingo, Ltd.**, Yoqneam Illit (IL)

(**) Term: **14 Years**

(21) Appl. No.: **29/288,894**

(22) Filed: **Jun. 25, 2007**

(51) **LOC (9) Cl.** **24-02**

(52) **U.S. Cl.** **D24/130**

(58) **Field of Classification Search** D24/108,
D24/111, 169, 186, 127, 130; 600/132, 134,
600/453, 160, 459, 461, 142, 131; 348/75,
348/65; 128/877-878, 879, DIG. 1, DIG. 2;
604/180, 192, 197, 198, 175, 154-155, 891.1;
417/477.2

See application file for complete search history.

(56) **References Cited**

U.S. PATENT DOCUMENTS

D363,543	S	*	10/1995	Van Funderburk et al.	.	D24/130
5,931,815	A	*	8/1999	Liu	604/171
D424,693	S	*	5/2000	Pruter	D24/130
6,835,190	B2	*	12/2004	Nguyen	604/198
7,214,211	B2	*	5/2007	Woehr et al.	604/164.08
2005/0273076	A1	*	12/2005	Beasley et al.	604/526
2006/0129090	A1	*	6/2006	Moberg et al.	604/93.01

* cited by examiner

Primary Examiner—T. Chase Nelson
Assistant Examiner—Eric L Goodman
(74) *Attorney, Agent, or Firm*—Mintz, Levin, Cohn, Ferris,
Glovsky and Popeo PC

(57) **CLAIM**

The ornamental design for a protector for use with infusion pumps, as shown and described.

DESCRIPTION

FIG. 1 is a front side view of a protector for use with infusion pumps;

FIG. 2 is a back side view of a protector for use with infusion pumps;

FIG. 3 is a right side view of a protector for use with infusion pumps;

FIG. 4 is a left side view of a protector for use with infusion pumps;

FIG. 5 is a top view of a protector for use with infusion pumps;

FIG. 6 is a bottom view of a protector for use with infusion pumps;

FIG. 7 is a first isometric view of a protector for use with infusion pumps;

FIG. 8 is a second isometric view of a protector for use with infusion pumps; and,

FIG. 9 is a third isometric view of a protector for use with infusion pumps.

1 Claim, 8 Drawing Sheets

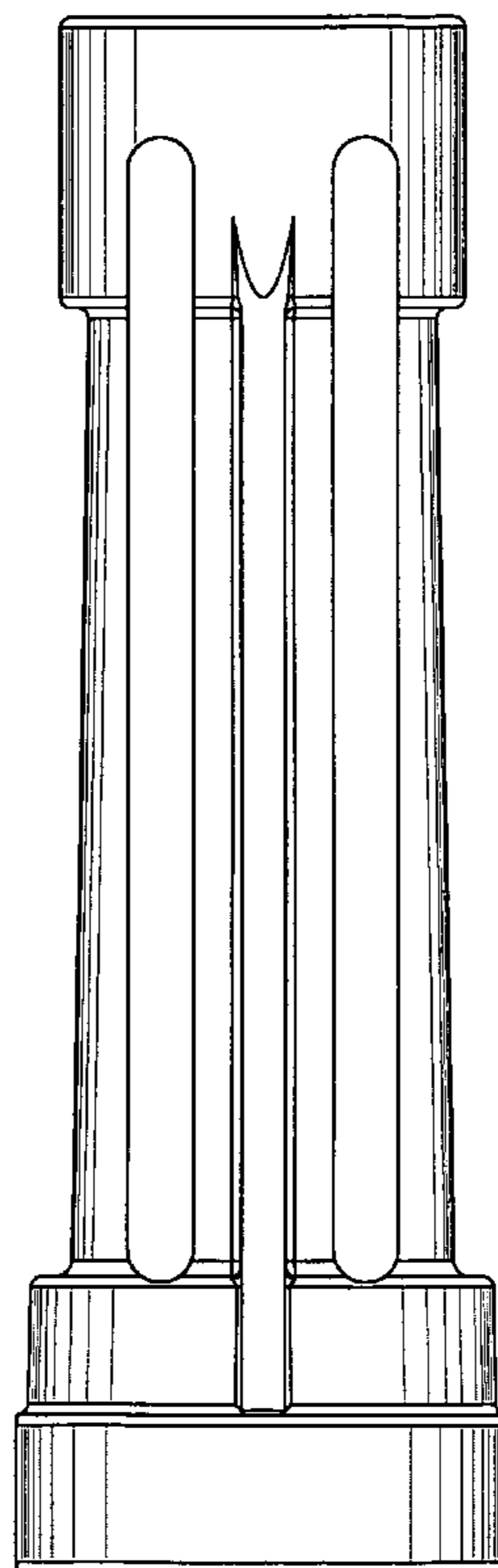

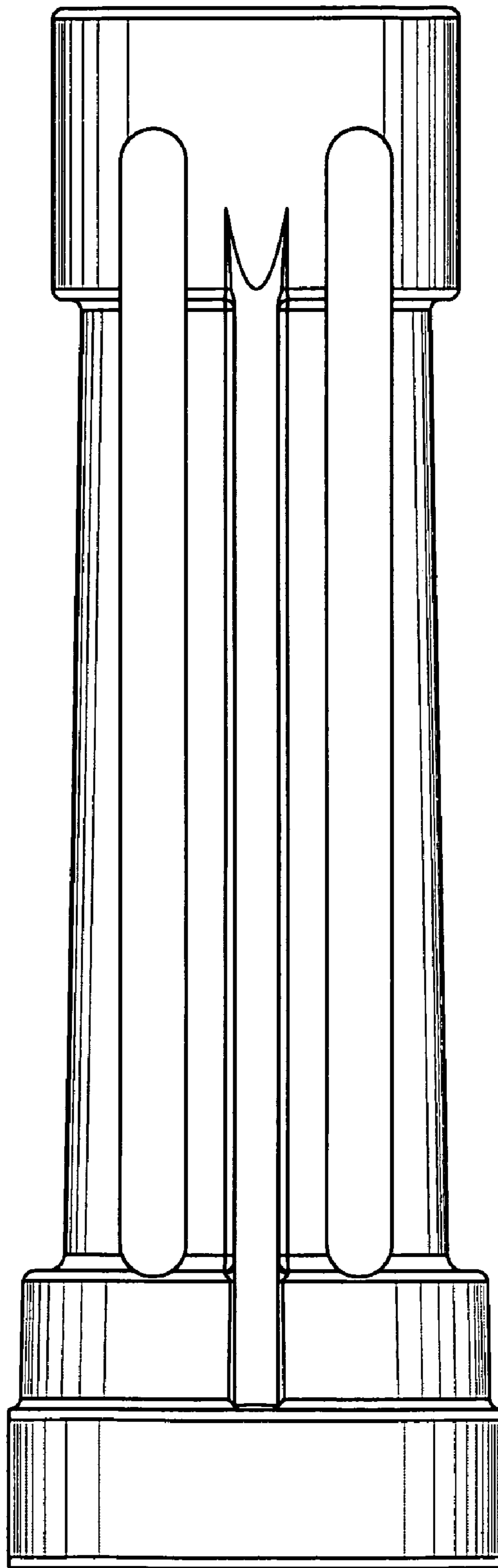

Fig. 1

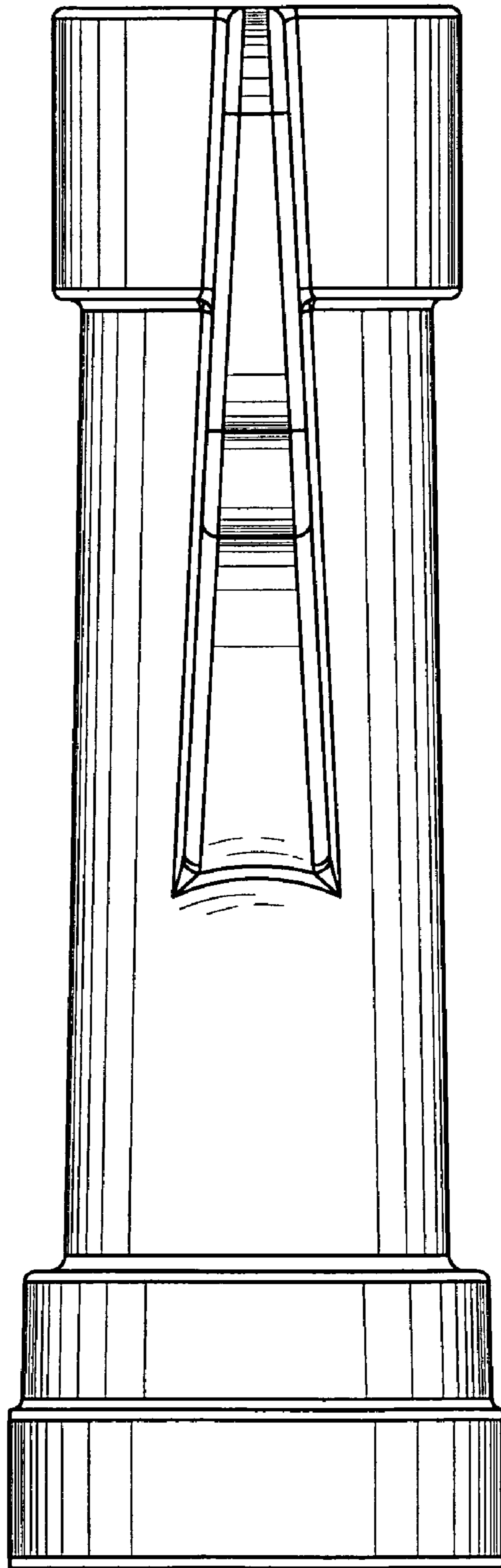

Fig. 2

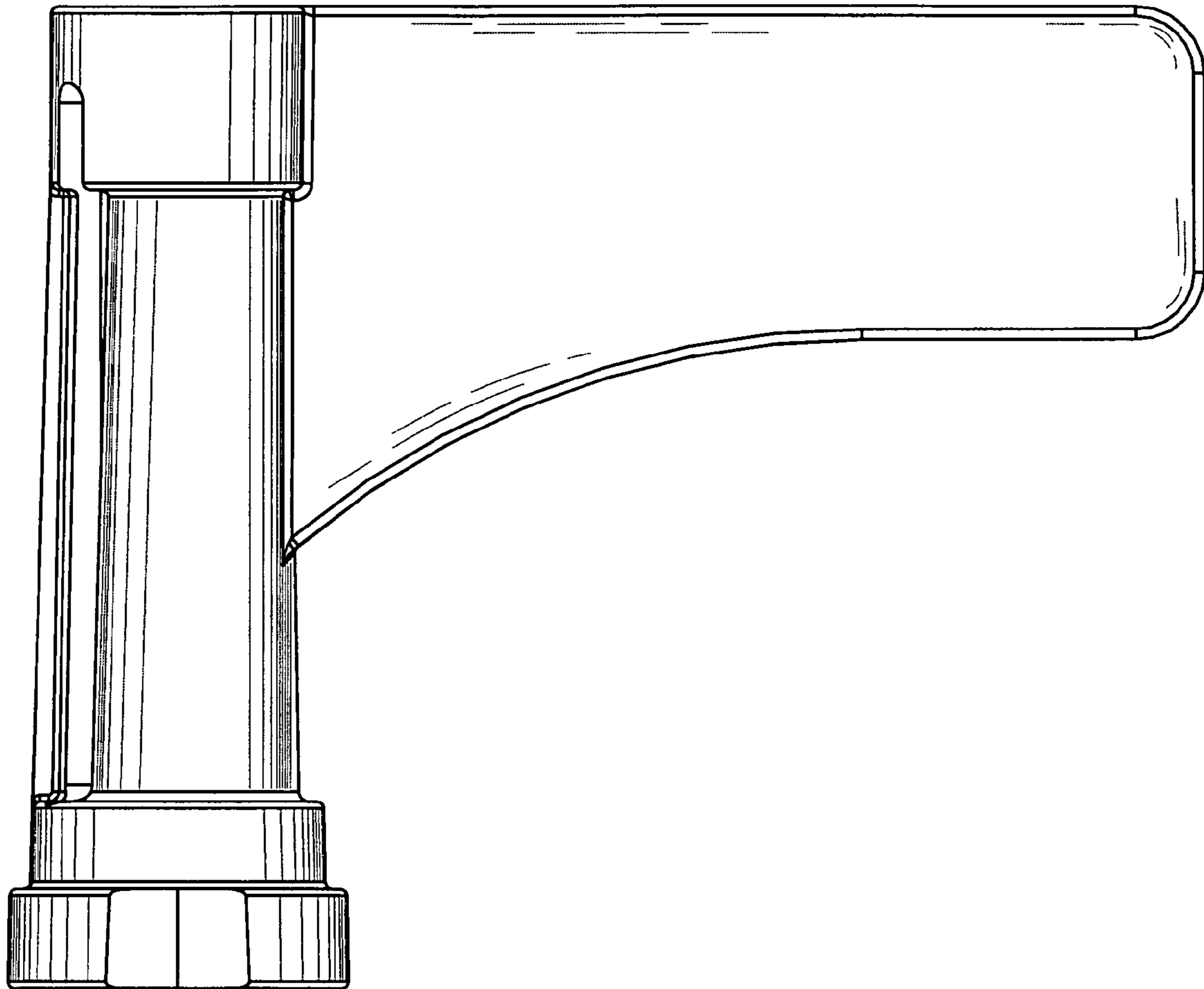

Fig. 3

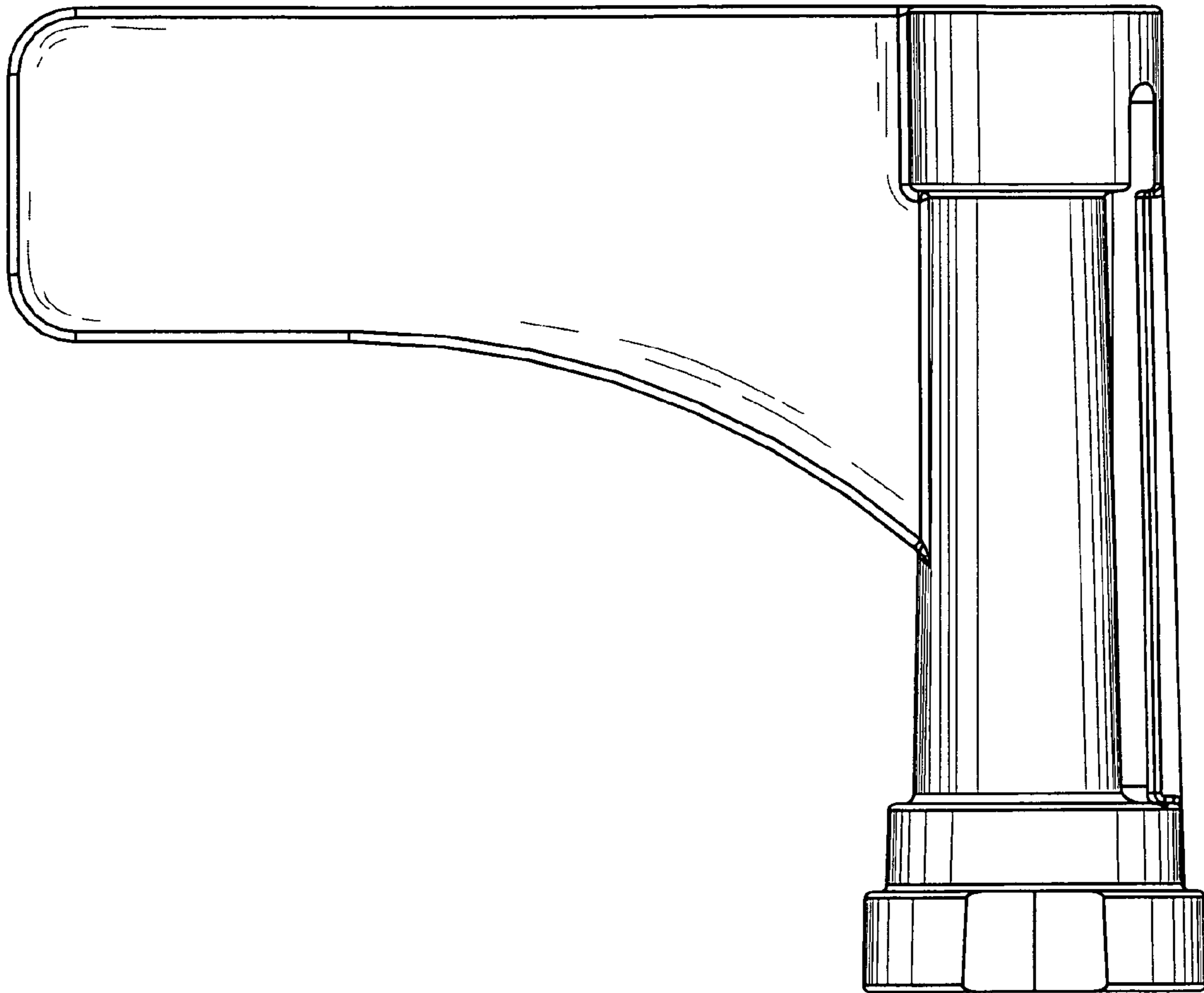

Fig. 4

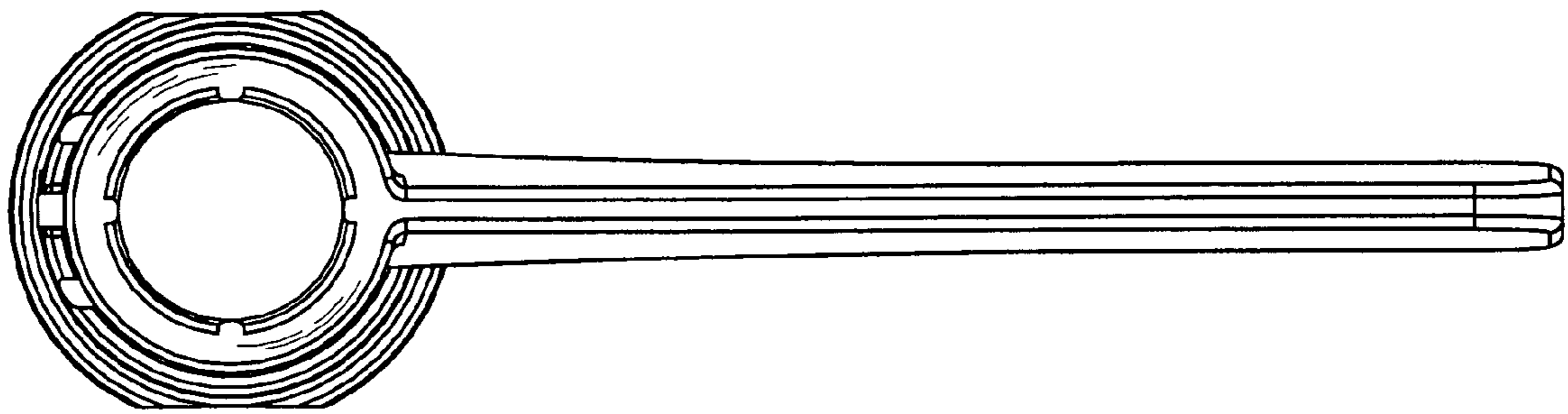

Fig. 5

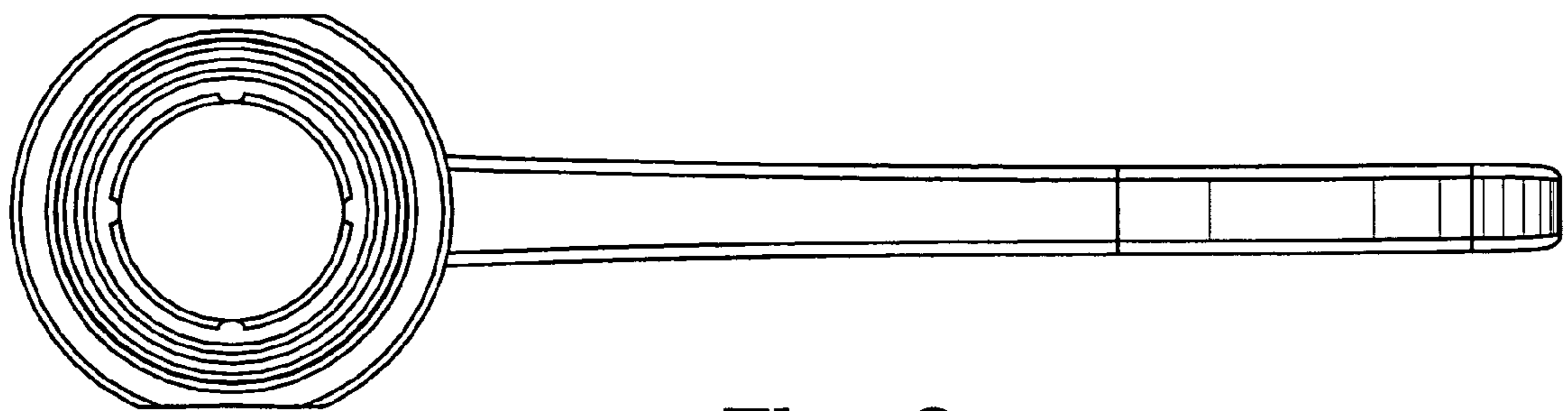

Fig. 6

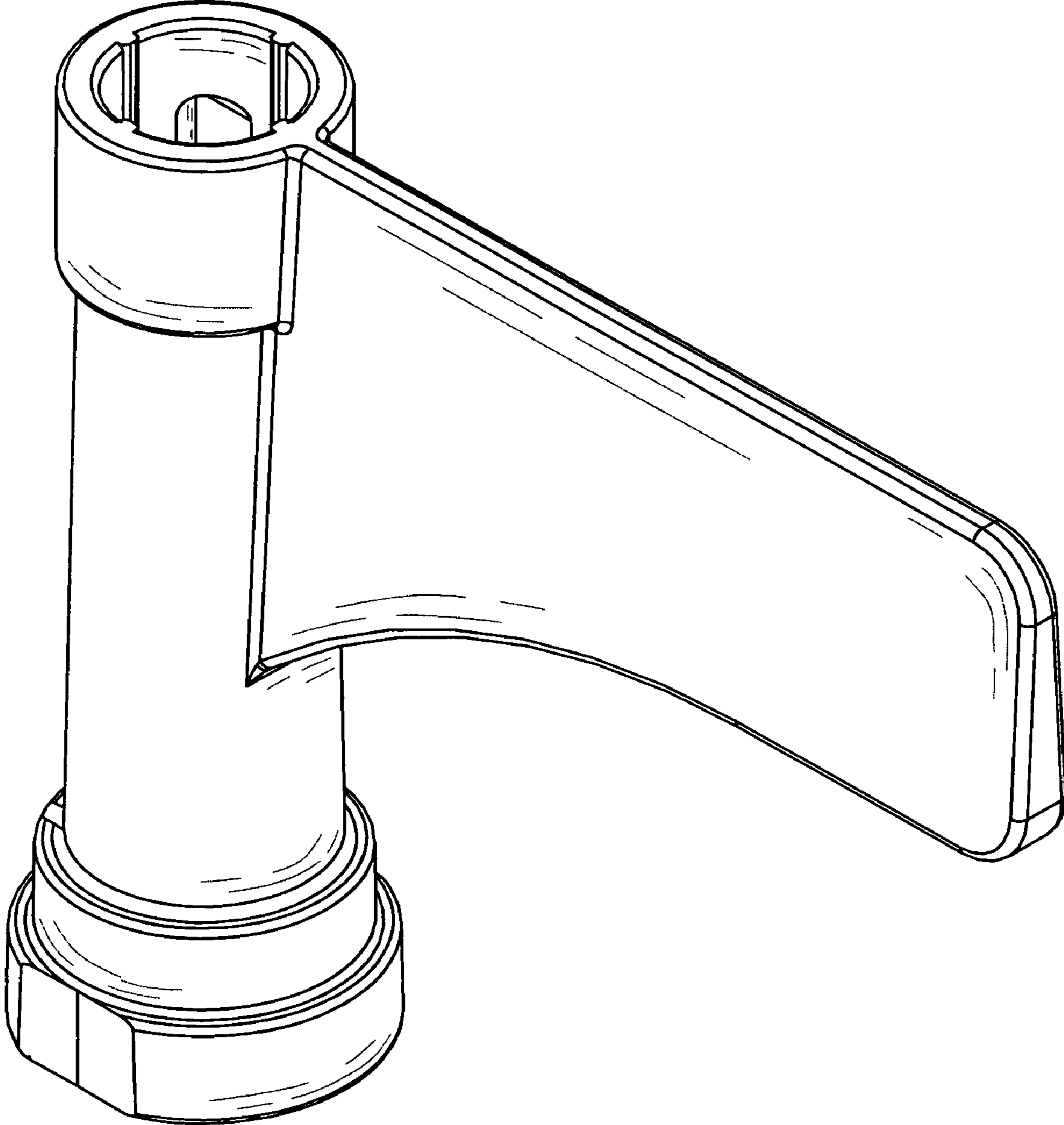

Fig. 7

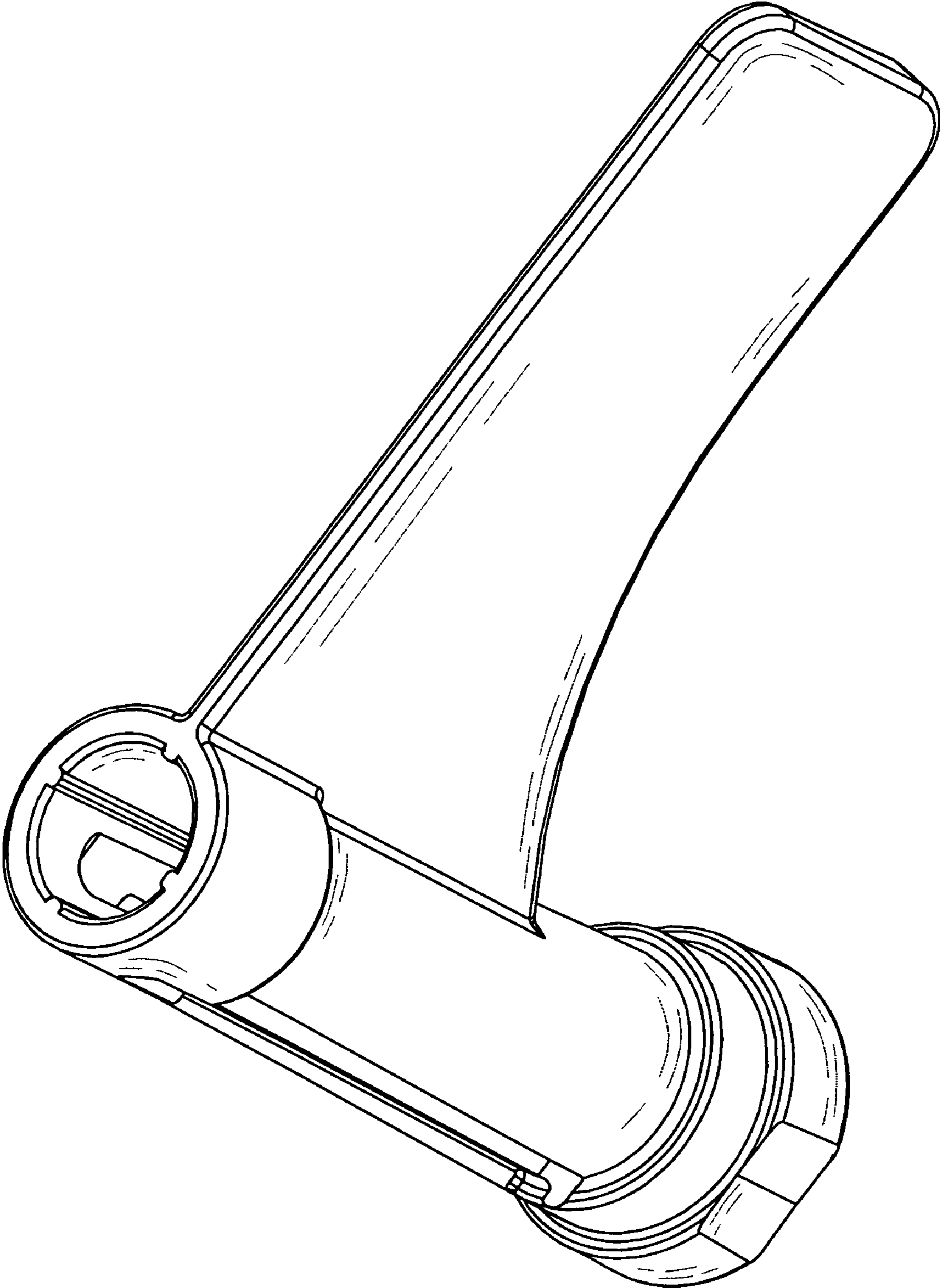

Fig. 8

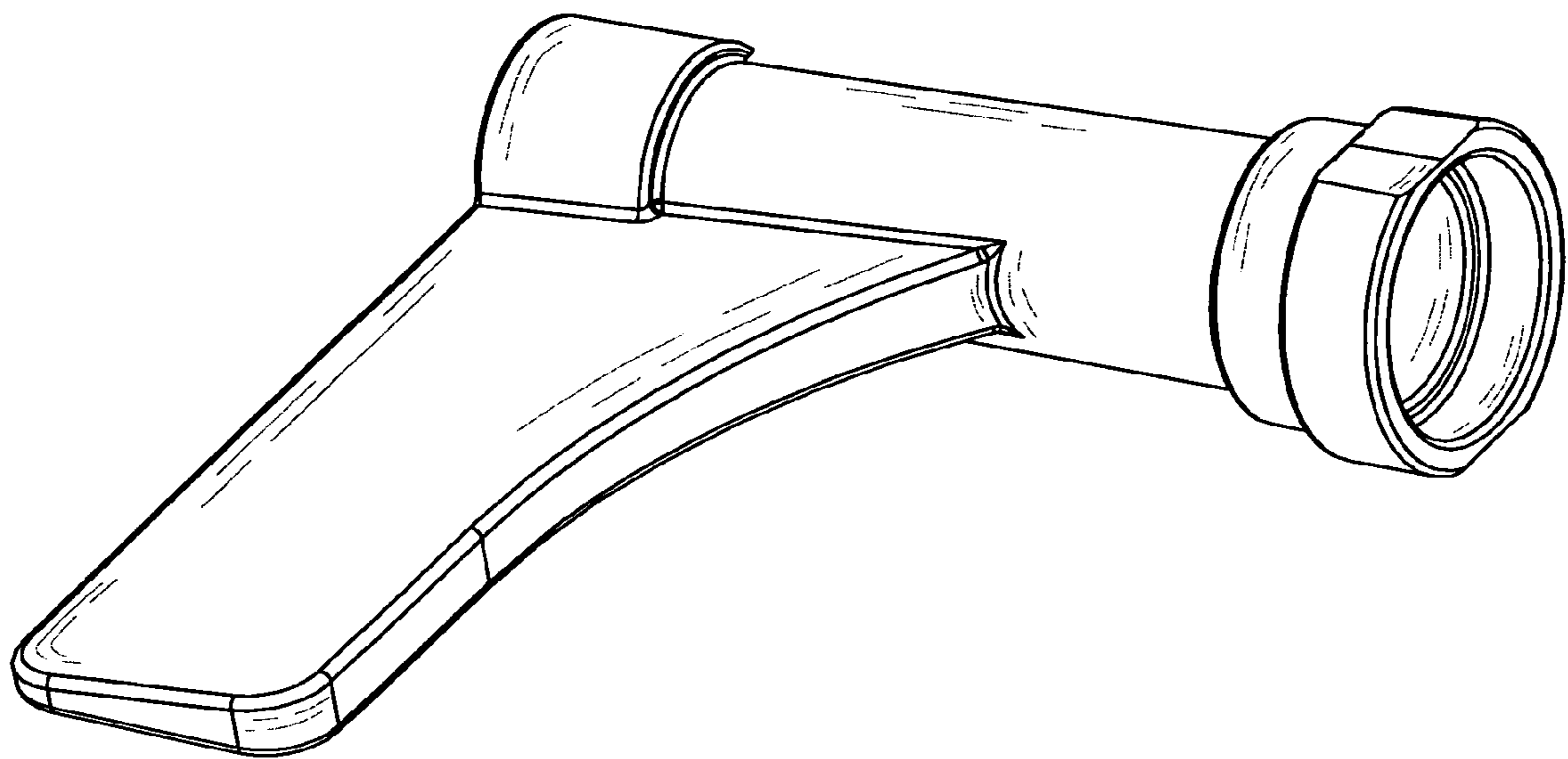

Fig. 9