



US00D611122S

(12) **United States Design Patent**
Rossiter et al.

(10) **Patent No.:** **US D611,122 S**
(45) **Date of Patent:** **** Mar. 2, 2010**

(54) **SPRAY CONTROLLER**

(75) Inventors: **William Rossiter**, Churchill (GB);
Edwin Ozaki Owen, Welwyn Garden
City (GB)

(73) Assignee: **No Climb Products Limited** (GB)

(**) Term: **14 Years**

(21) Appl. No.: **29/327,837**

(22) Filed: **Nov. 14, 2008**

(51) **LOC (9) Cl.** **23-01**

(52) **U.S. Cl.** **D23/213; D9/448**

(58) **Field of Classification Search** D23/213,
D23/223; 222/182, 402.12; D9/435, 448;
239/589

See application file for complete search history.

(56) **References Cited**

U.S. PATENT DOCUMENTS

| | | | | | |
|--------------|-----|---------|------------------|-------|------------|
| 3,702,668 | A * | 11/1972 | Landen | | 222/182 |
| 3,935,999 | A * | 2/1976 | Weyn | | 239/288.5 |
| 4,637,528 | A | 1/1987 | Wachinski et al. | | 222/182 |
| 4,815,637 | A * | 3/1989 | Nellis | | 222/402.12 |
| 5,361,623 | A | 11/1994 | Wantz | | 73/1 G |
| D353,537 | S * | 12/1994 | Starrett | | D9/688 |
| D529,383 | S * | 10/2006 | Haworth | | D9/448 |
| D597,206 | S * | 7/2009 | Collins et al. | | D24/150 |
| 2003/0029447 | A1 | 2/2003 | Vito | | 128/200.23 |

FOREIGN PATENT DOCUMENTS

| | | |
|----|-----------|---------|
| EP | 0 255 575 | 5/1987 |
| FR | 2 405 756 | 10/1976 |
| GB | 864 175 | 9/1958 |

| | | |
|----|--------------|---------|
| GB | 2 181 489 | 4/1987 |
| JP | 07275759 A | 10/1995 |
| JP | 08309240 | 11/1996 |
| JP | 2005288359 A | 10/2005 |

* cited by examiner

Primary Examiner—Robin V Webster

(74) *Attorney, Agent, or Firm*—Renner Kenner Greive Bobak
Taylor & Weber

(57) **CLAIM**

The ornamental design for a spray controller, as shown and described.

DESCRIPTION

FIG. 1 is a top perspective view of a spray controller showing our new design in an expanded condition;

FIG. 2 is a bottom perspective view thereof;

FIG. 3 is a front view thereof;

FIG. 4 is a rear view thereof;

FIG. 5 is a left side view thereof;

FIG. 6 is a right side view thereof;

FIG. 7 is an enlarged top view thereof;

FIG. 8 is an enlarged bottom view thereof;

FIG. 9 is a top perspective view of the spray controller showing our new design in a collapsed condition;

FIG. 10 is a bottom perspective view thereof;

FIG. 11 is a front view thereof, wherein the opposite side view is a mirror-image thereof; and,

FIG. 12 is a left side view thereof.

1 Claim, 12 Drawing Sheets

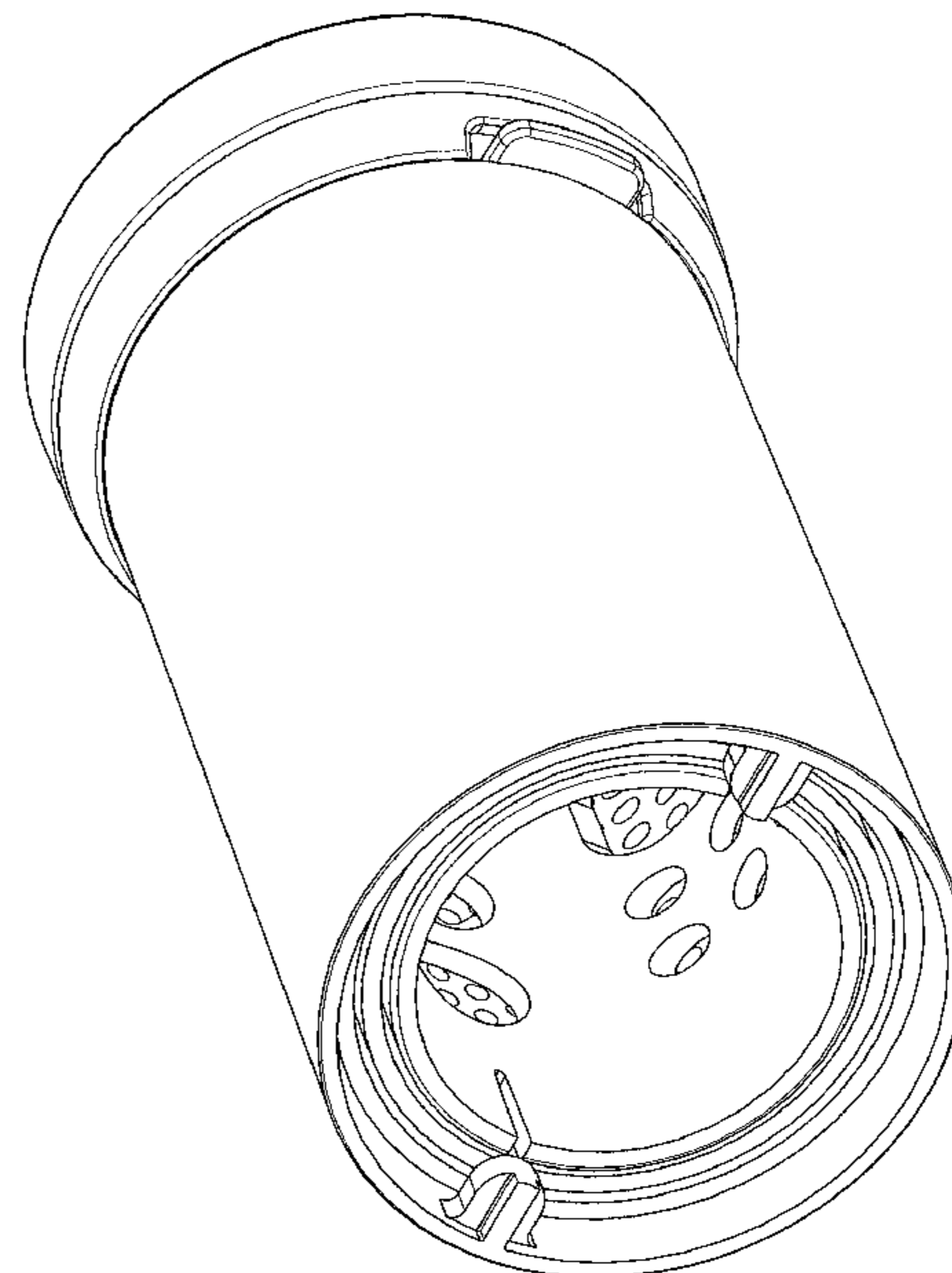
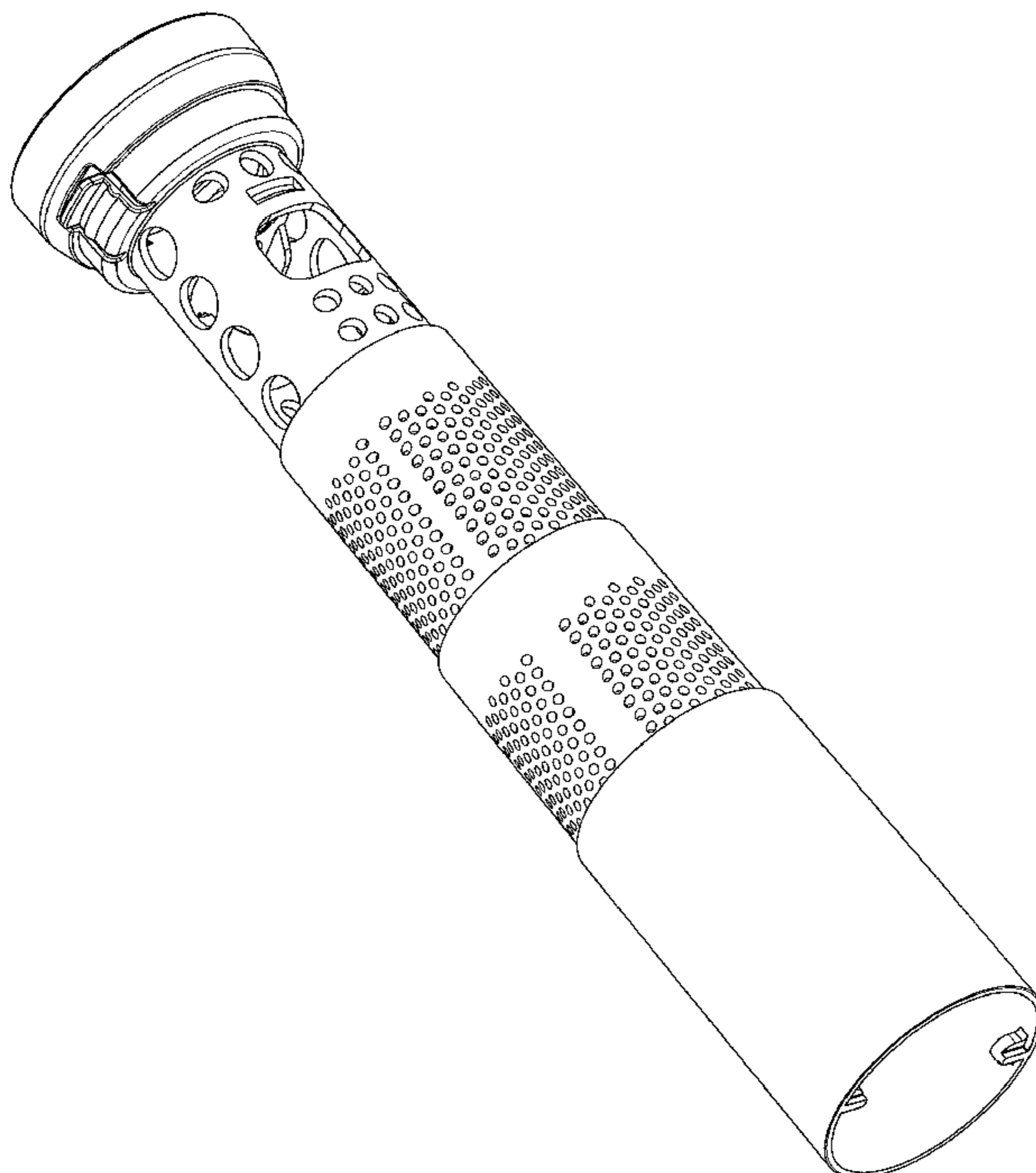

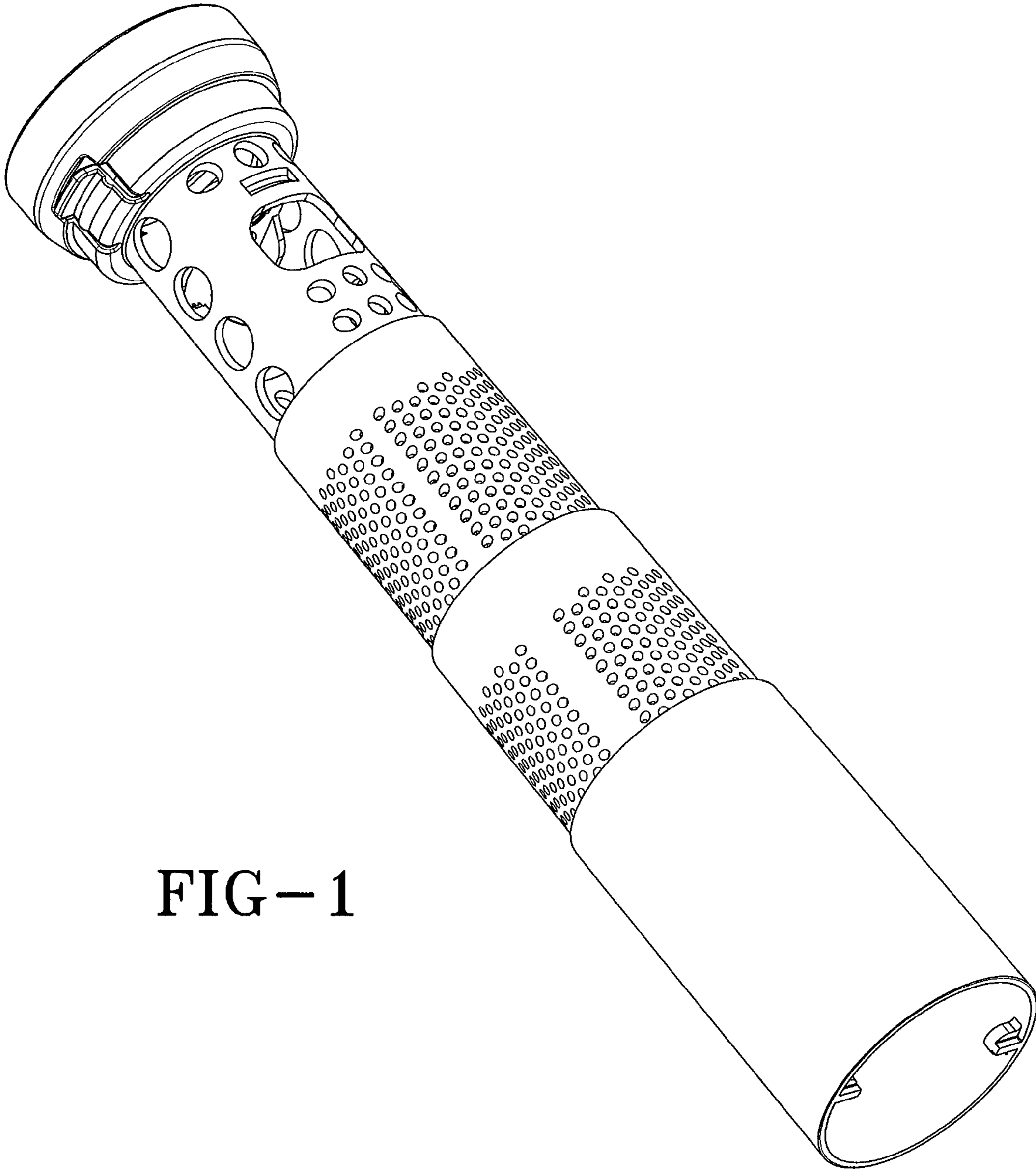

FIG-1

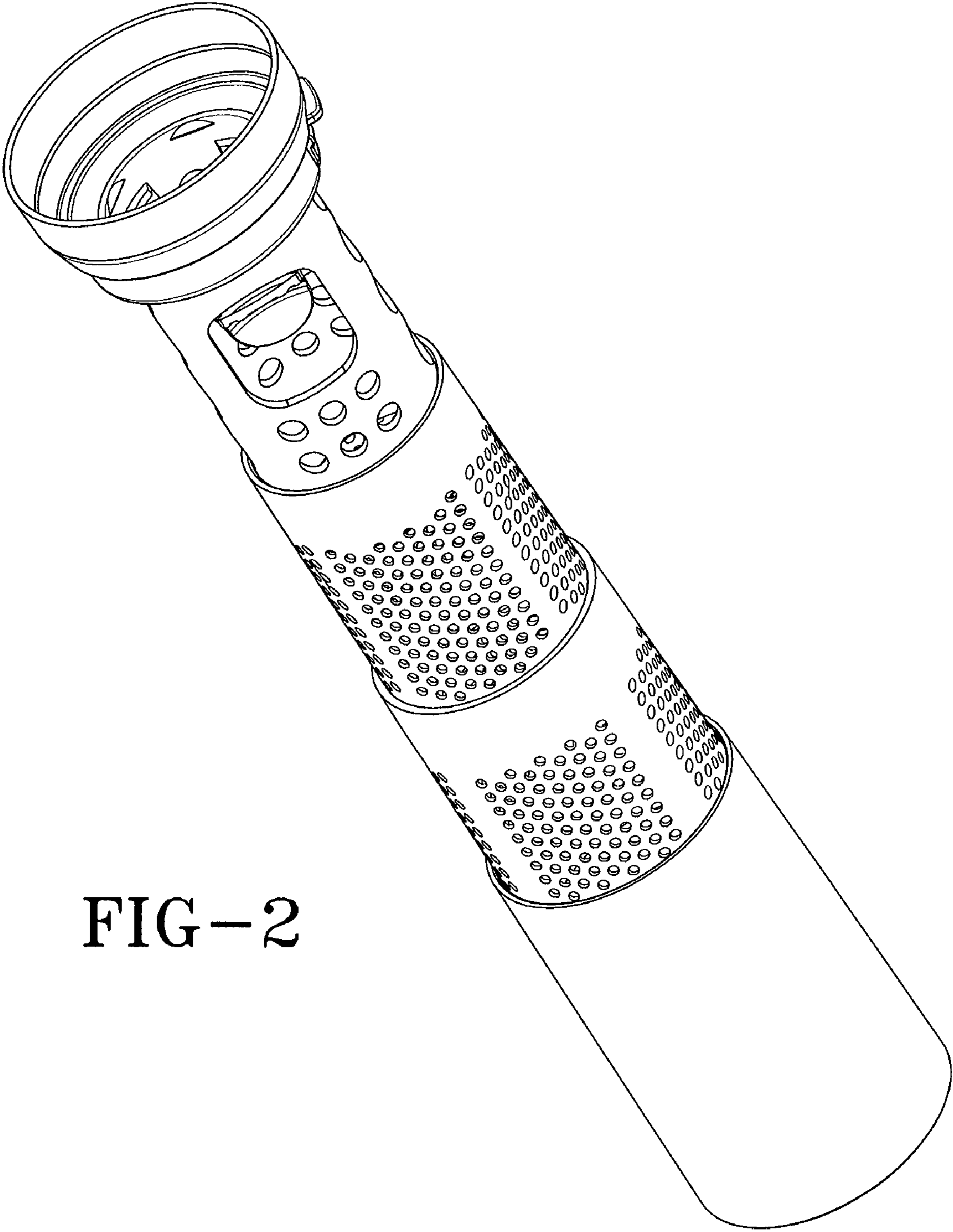

FIG-2

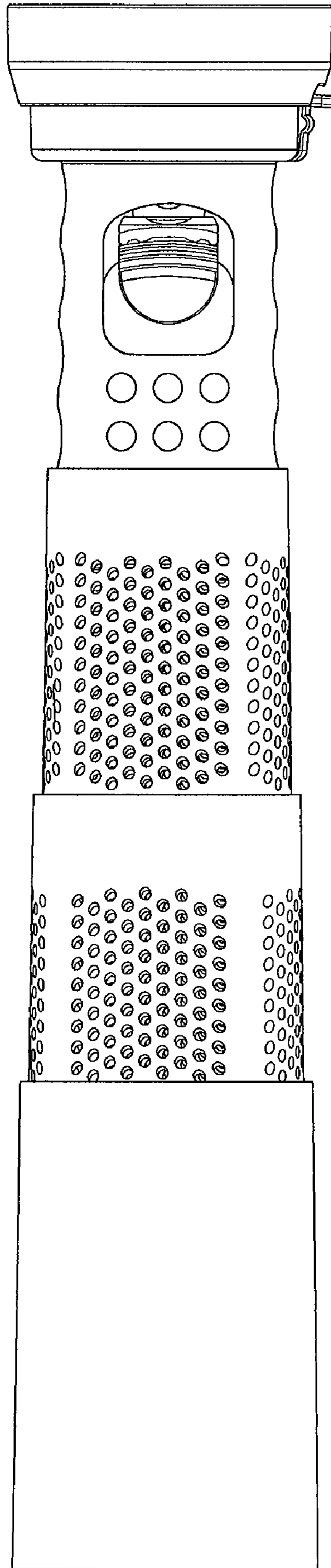

FIG-3

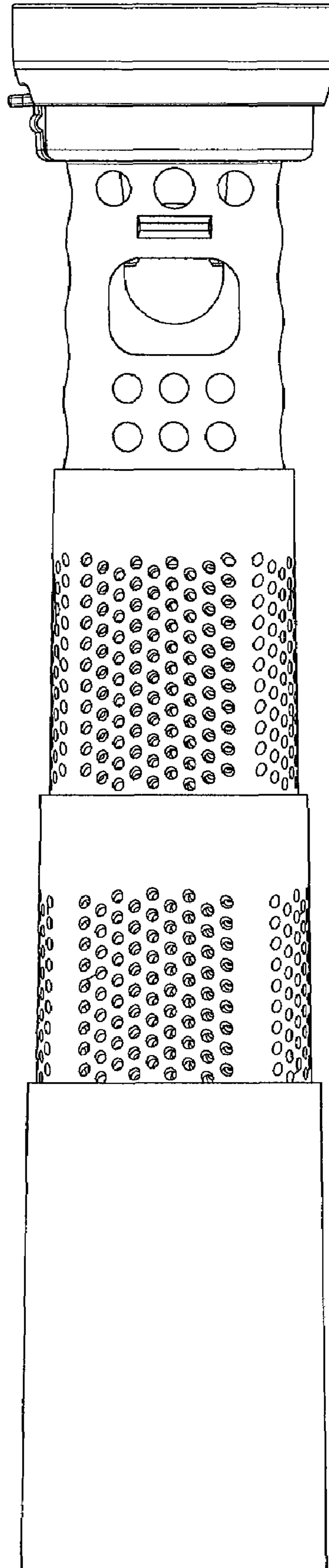

FIG-4

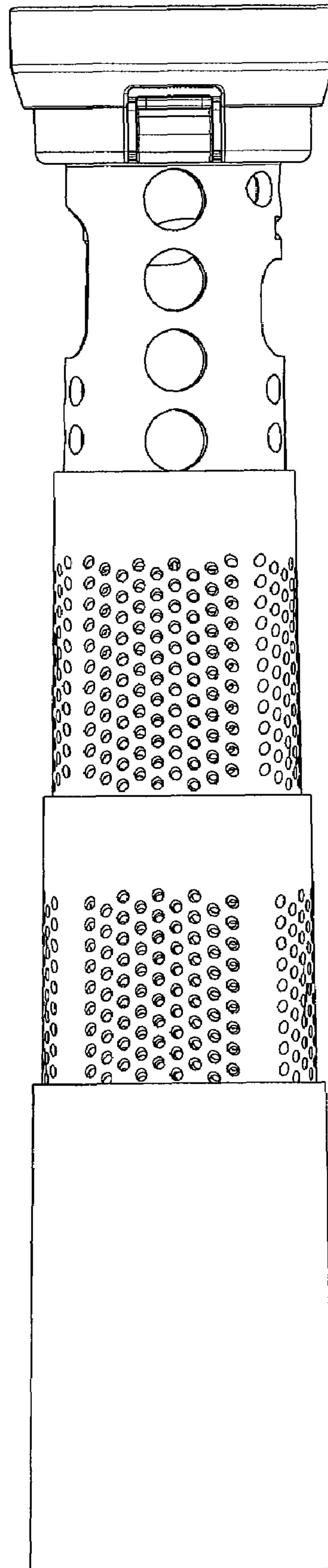

FIG-5

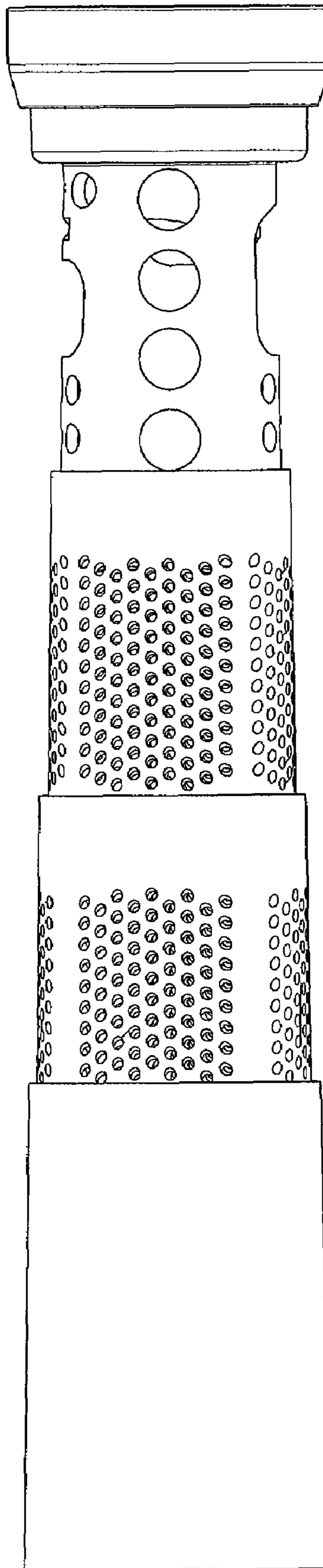

FIG-6

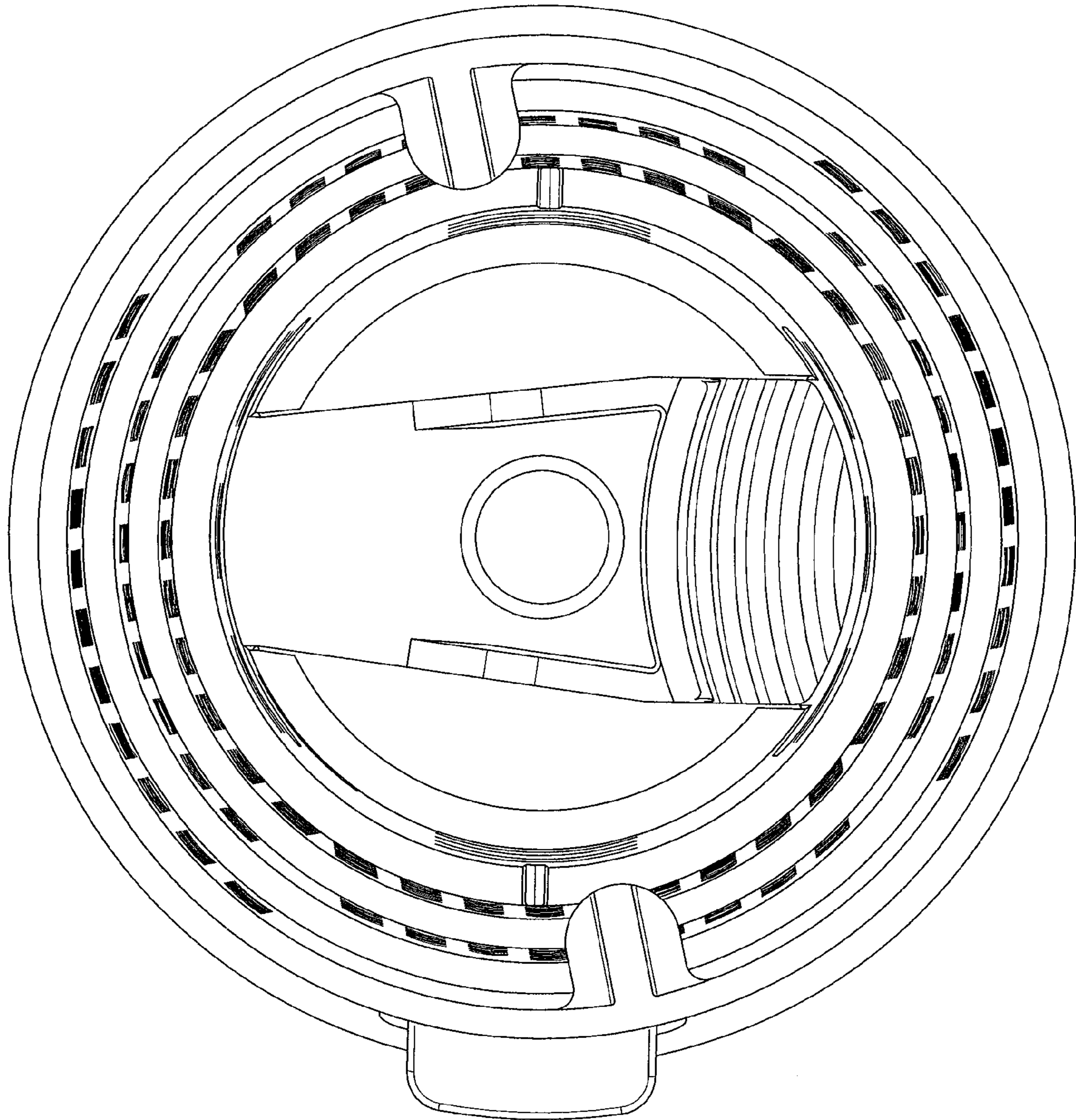

FIG-7

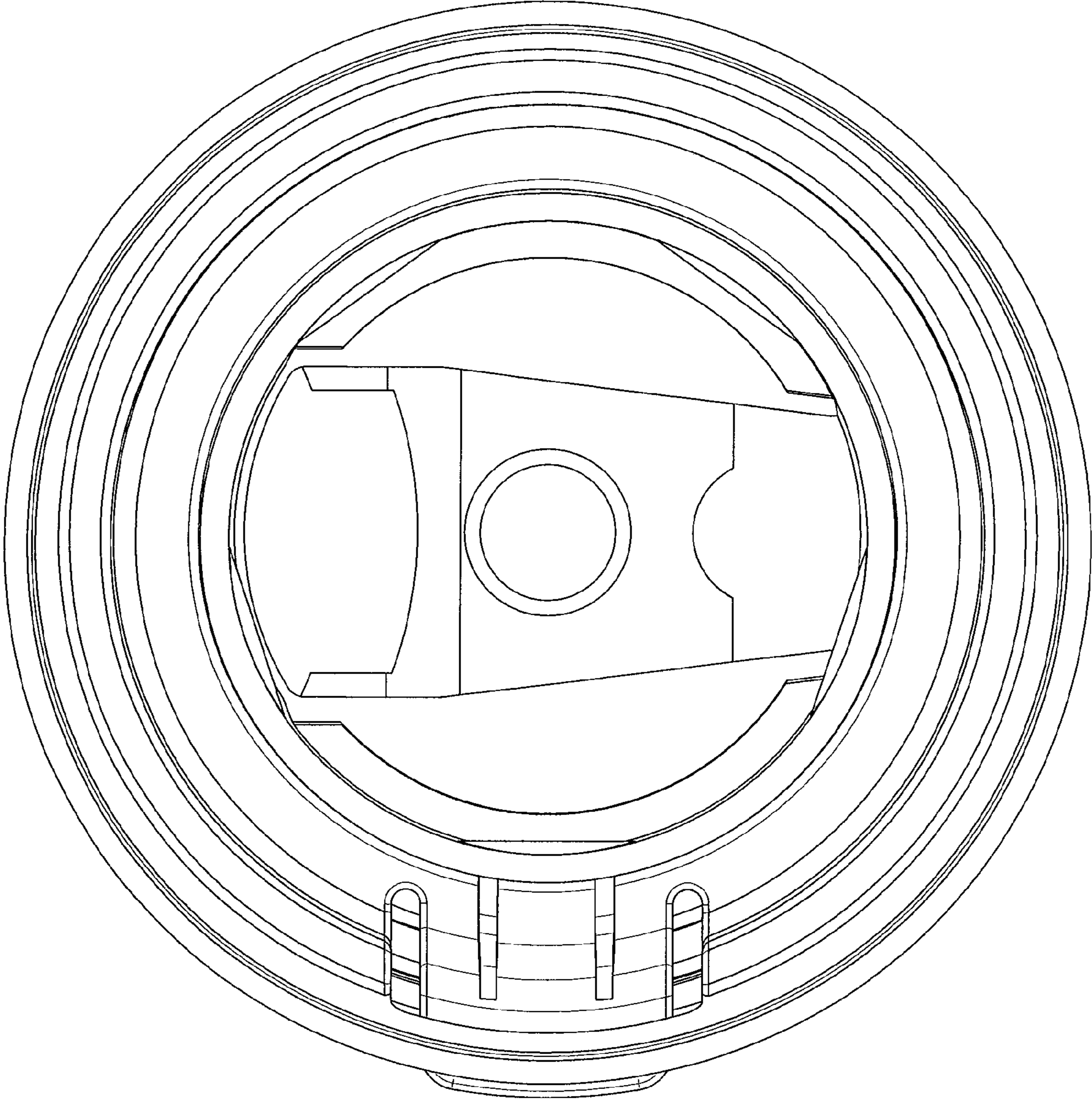

FIG-8

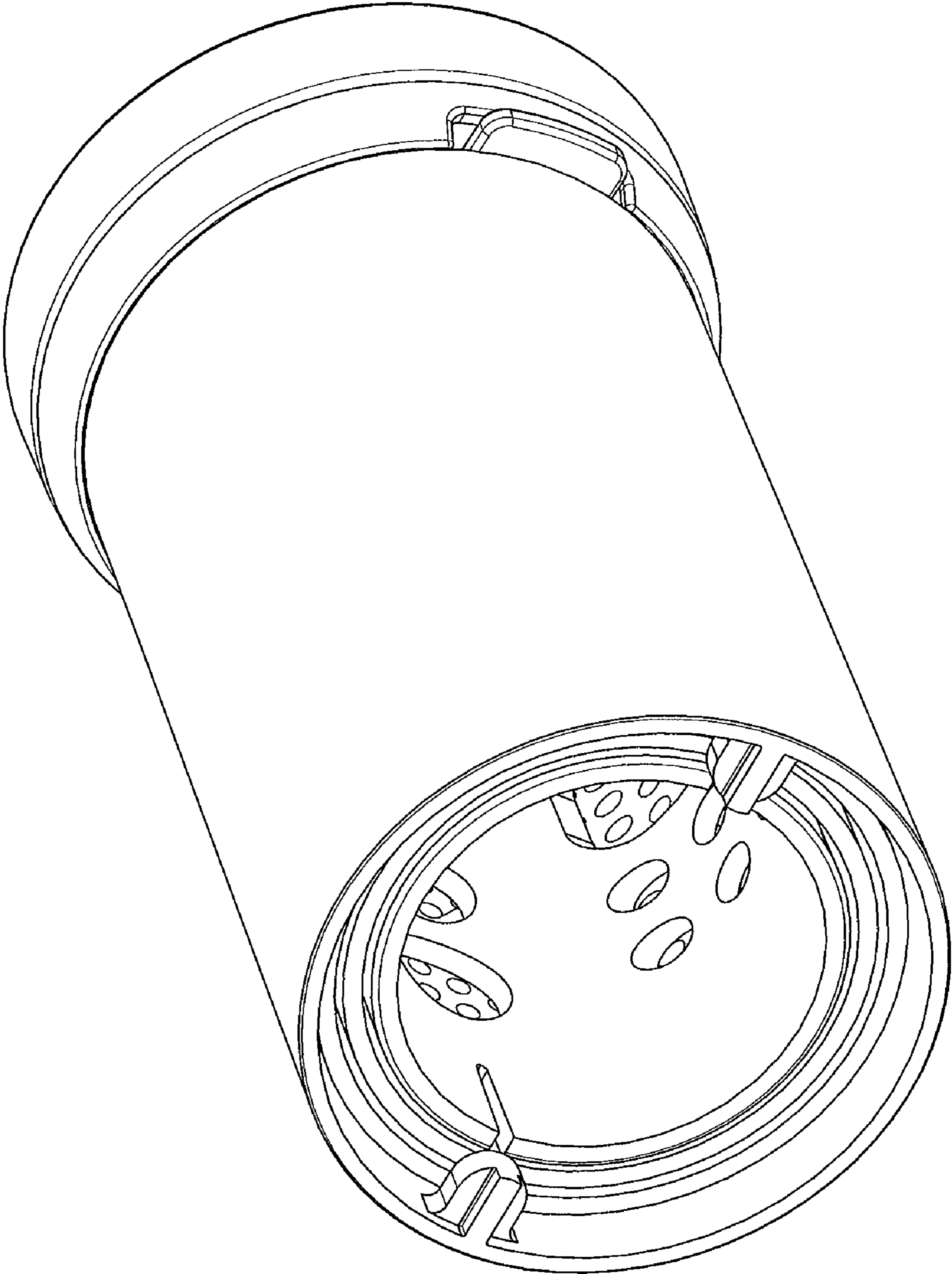

FIG-9



FIG-10

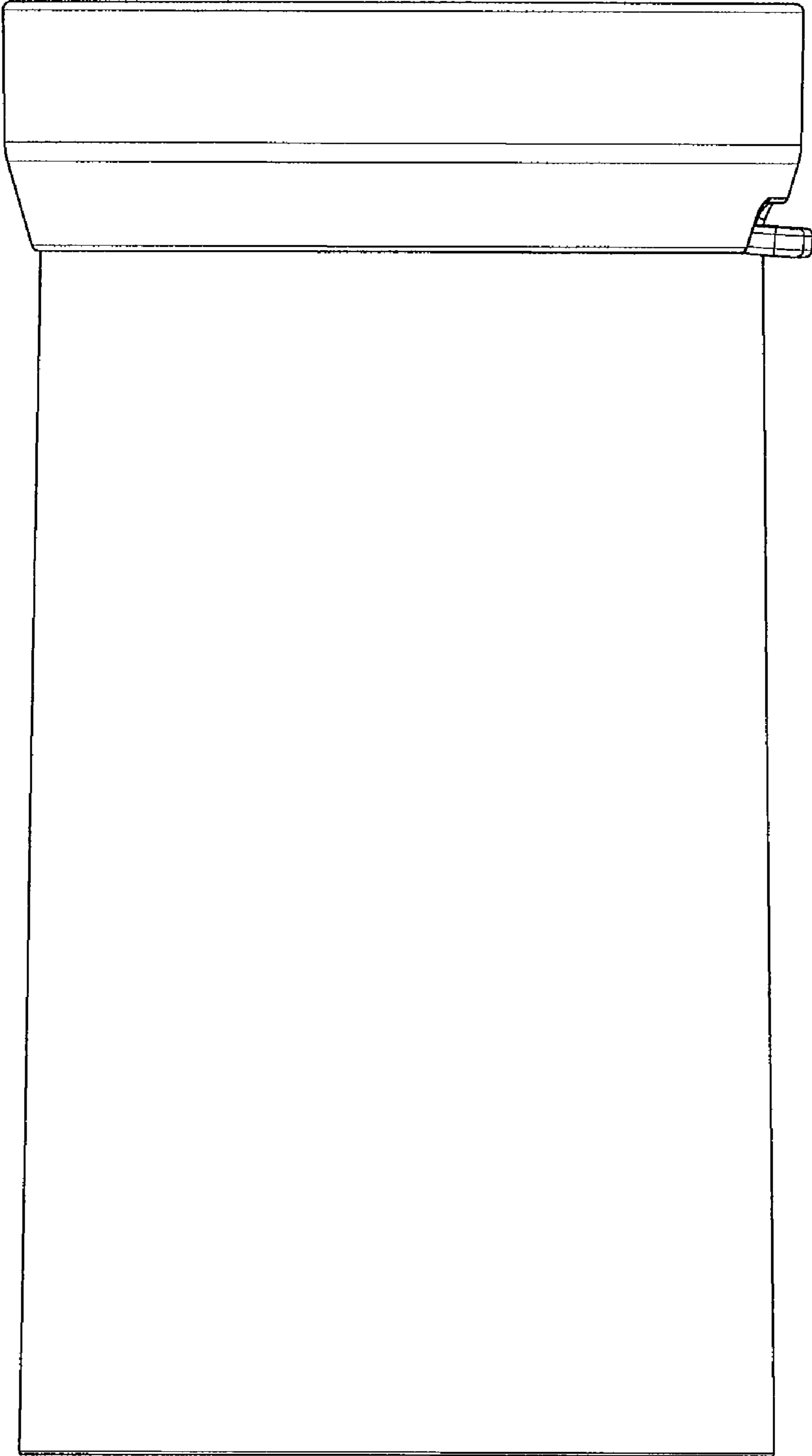

FIG-11

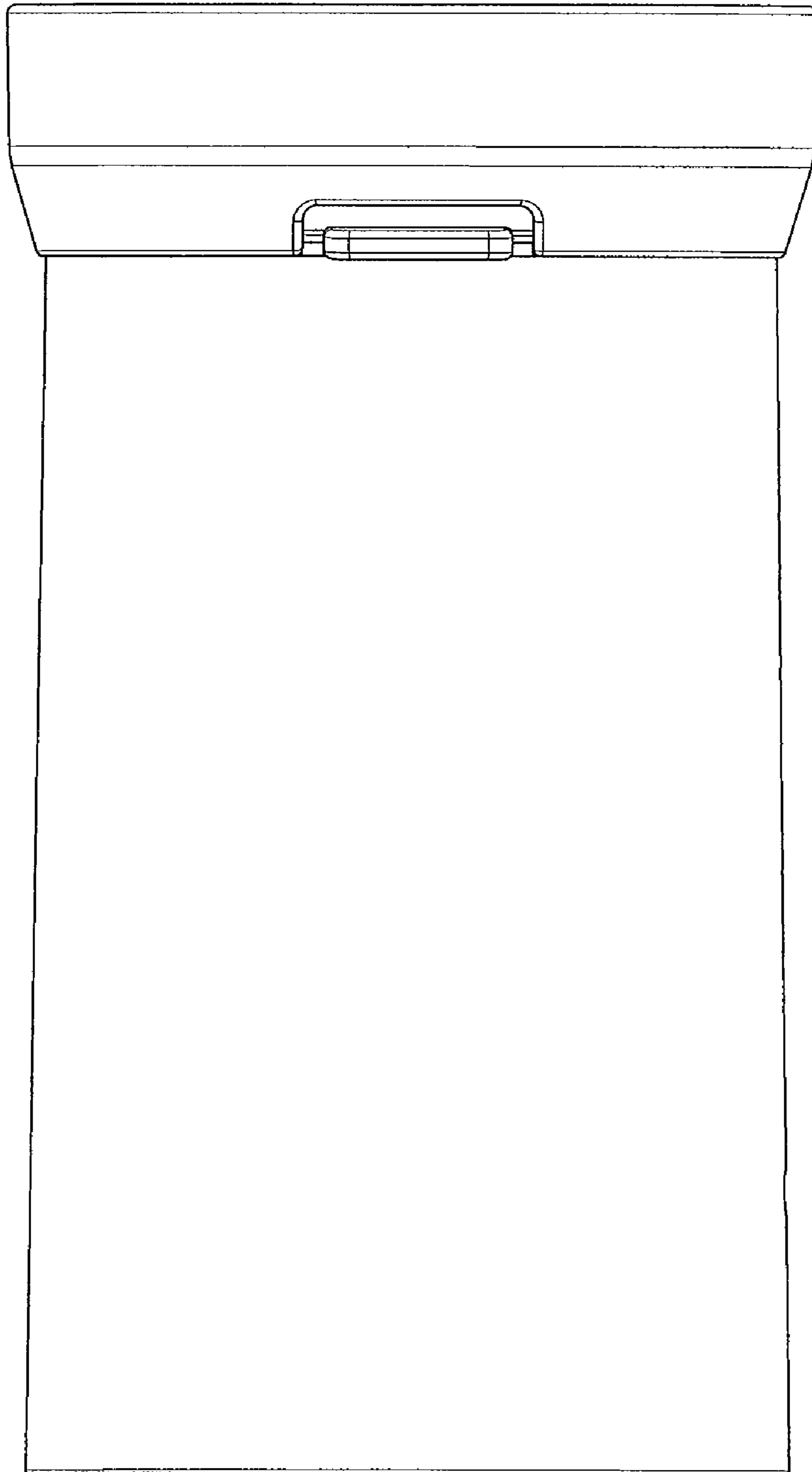

FIG-12