



US00D611073S

(12) **United States Design Patent**
Ettlin

(10) **Patent No.:** **US D611,073 S**
(45) **Date of Patent:** **** *Mar. 2, 2010**

(54) **MIXER HAVING A COLORED COUPLING PORTION**

(75) Inventor: **Josef Ettlin**, Eichberg (CH)

(73) Assignee: **Sulzer Mixpac AG**, Rotkreuz (CH)

(*) Notice: This patent is subject to a terminal disclaimer.

(**) Term: **14 Years**

(21) Appl. No.: **29/329,297**

(22) Filed: **Dec. 11, 2008**

(30) **Foreign Application Priority Data**

Jun. 12, 2008 (EM) 000960802

(51) **LOC (9) Cl.** **15-09**

(52) **U.S. Cl.** **D15/138**

(58) **Field of Classification Search** D8/382;
D15/138, 139, 140, 147; D16/235; 222/1,
222/129.1, 145.5, 459; 239/296, 398, 399,
239/400, 414, 417.5, 418, 424.5, 428, 429,
239/432, 433, 434.5, 488, 500
See application file for complete search history.

(56) **References Cited**

U.S. PATENT DOCUMENTS

- 2,296,718 A * 9/1942 Kyprie 239/315
- 2,539,315 A * 1/1951 Murphy 239/404
- 2,620,108 A * 12/1952 Copping 222/133
- 3,051,455 A * 8/1962 Magester 366/172.1
- 3,770,208 A * 11/1973 Mueller 239/417.3
- 4,690,333 A * 9/1987 Johansson 239/434.5
- 4,907,725 A * 3/1990 Durham 222/129.1
- 5,429,308 A * 7/1995 Brown 239/414
- 5,570,822 A * 11/1996 LeMarbe et al. 222/459
- 5,664,733 A * 9/1997 Lott 239/429
- D417,459 S * 12/1999 Shintani et al. D15/144
- 6,021,961 A * 2/2000 Brown 239/398
- D474,788 S * 5/2003 Molnar et al. D15/144

- D517,577 S * 3/2006 Conway et al. D15/144
- 7,032,843 B1 * 4/2006 Johnson et al. 239/488
- D521,035 S * 5/2006 de Leeuw et al. D15/144
- 7,051,954 B2 * 5/2006 Gerstner 239/398
- D584,751 S * 1/2009 Schreck D15/135
- 2004/0035952 A1 * 2/2004 Gerstner 239/433
- 2007/0131715 A1 * 6/2007 Minard et al. 222/145.5
- 2007/0278327 A1 * 12/2007 Wolfe 239/398

* cited by examiner

Primary Examiner—Sandra Snapp

Assistant Examiner—Patricia Palasik

(74) *Attorney, Agent, or Firm*—Townsend and Townsend and Crew LLP

(57) **CLAIM**

The ornamental design for a mixer having a colored coupling portion, as shown and described.

DESCRIPTION

The patent or patent application file contains at least one drawing (i.e., FIGS. 1–7) executed in color. Copies of this patent with color drawings will be provided by the Office upon request and payment of the necessary fee.

FIG. 1 is a perspective view of a mixer having a colored coupling portion showing my new design;

FIG. 2 is a front elevational view thereof;

FIG. 3 is a rear elevational view thereof;

FIG. 4 is a left side elevational view thereof;

FIG. 5 is a right side elevational view thereof;

FIG. 6 is a top plan view thereof; and,

FIG. 7 is a bottom plan view thereof.

The lighted areas surrounded by broken lines depict the boundaries of the claimed design and the logo, patent information and #'s shown in broken lines depict unclaimed environmental subject matter.

1 Claim, 4 Drawing Sheets
(4 of 4 Drawing Sheet(s) Filed in Color)

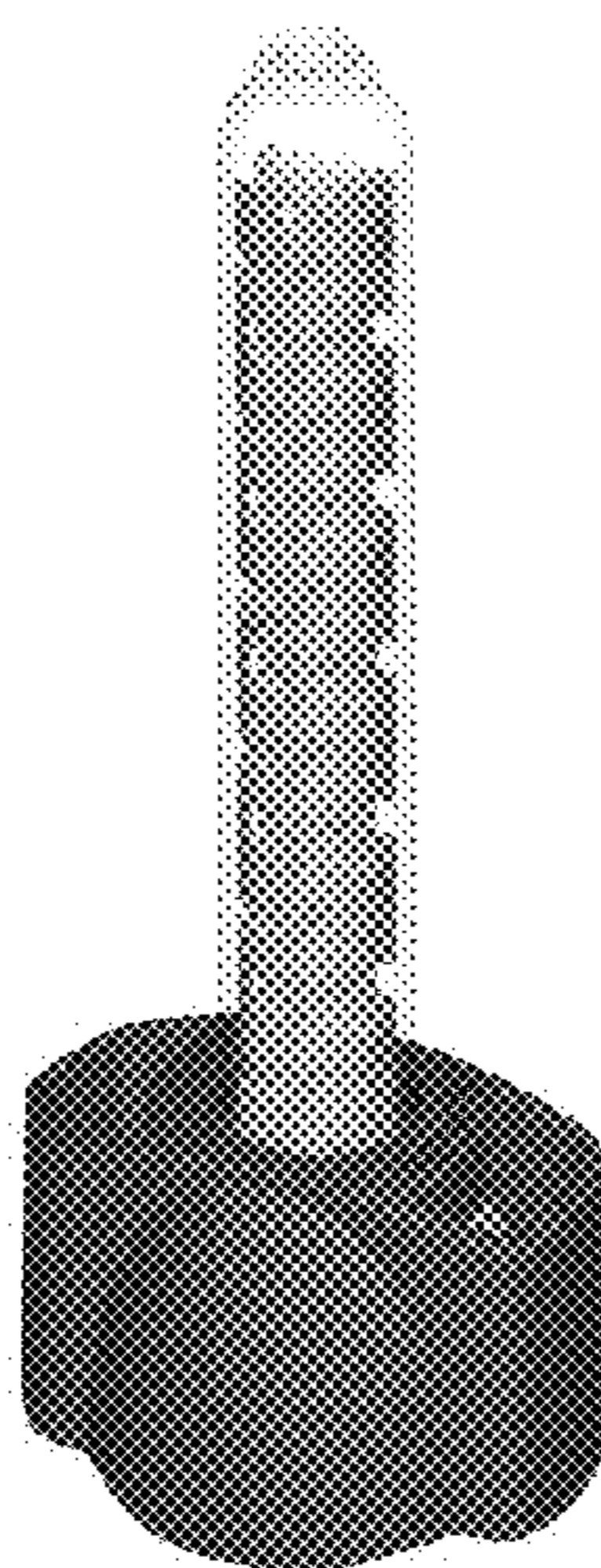

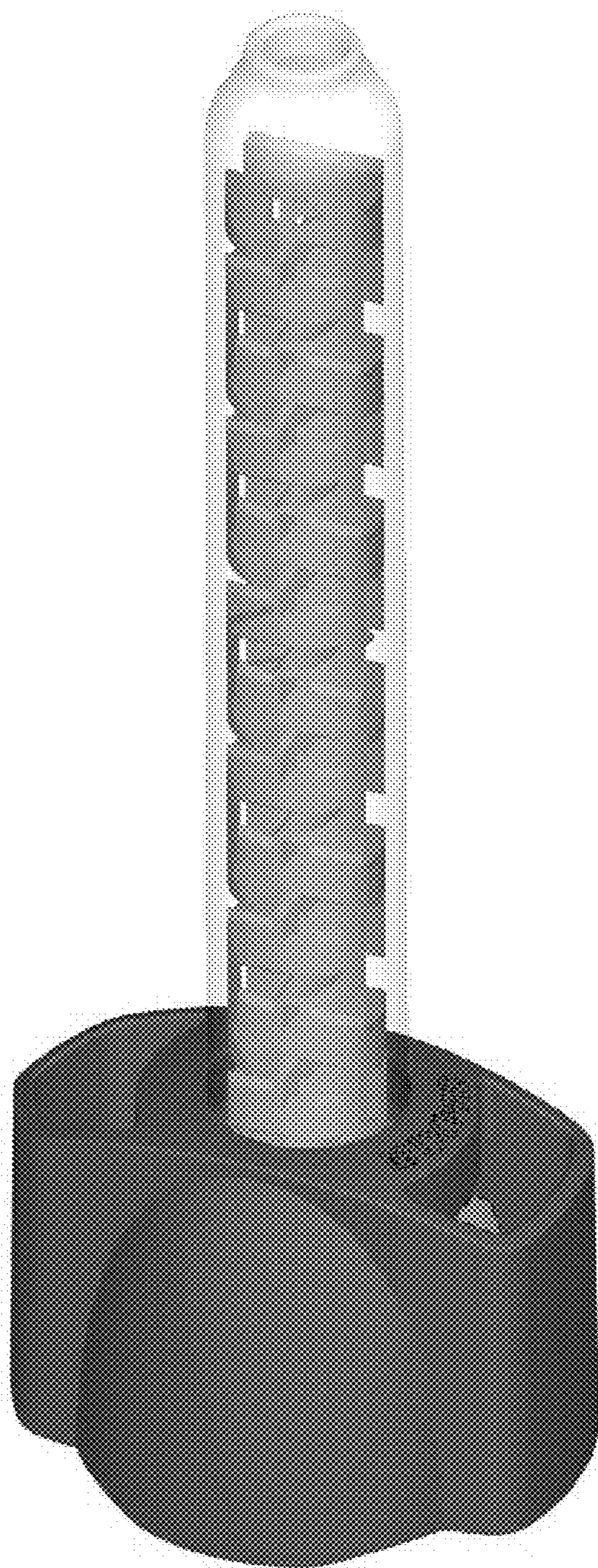

FIG. 1

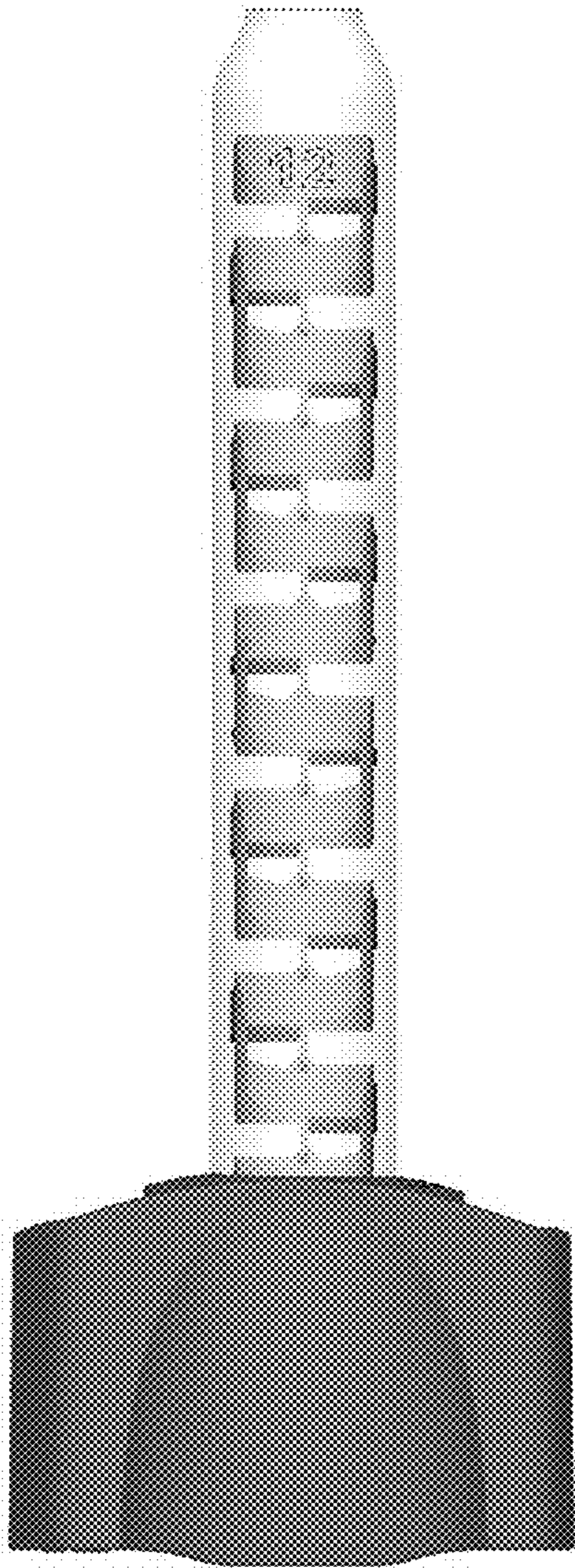

FIG. 2

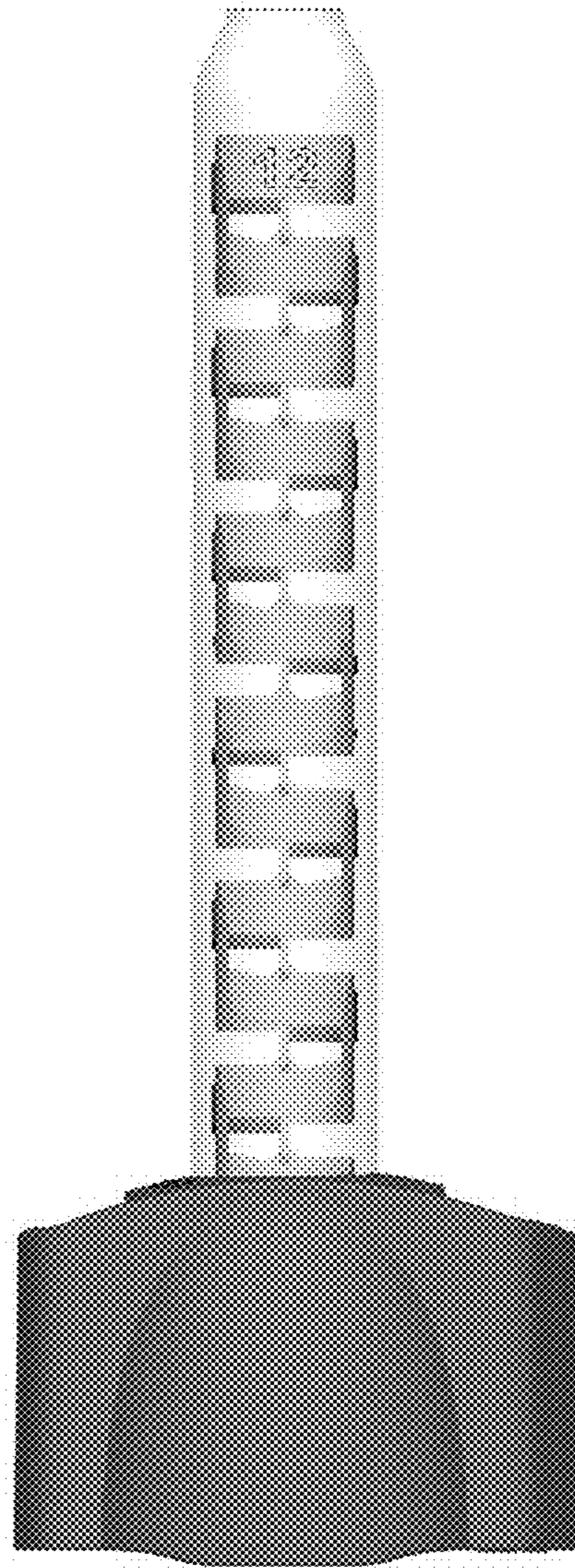

FIG. 3

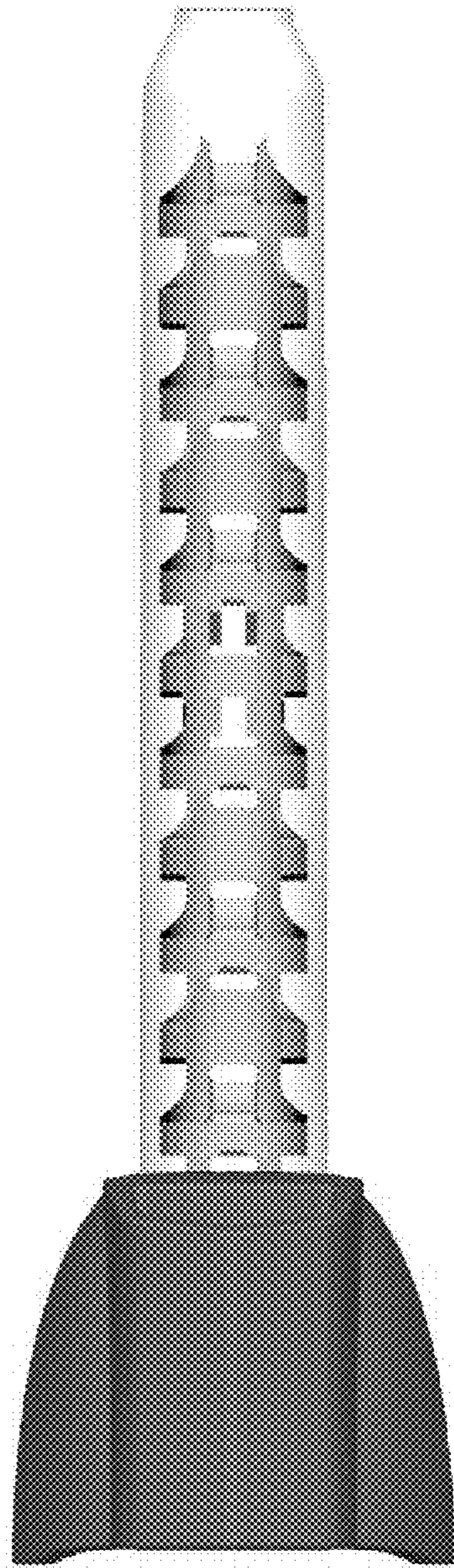

FIG. 4

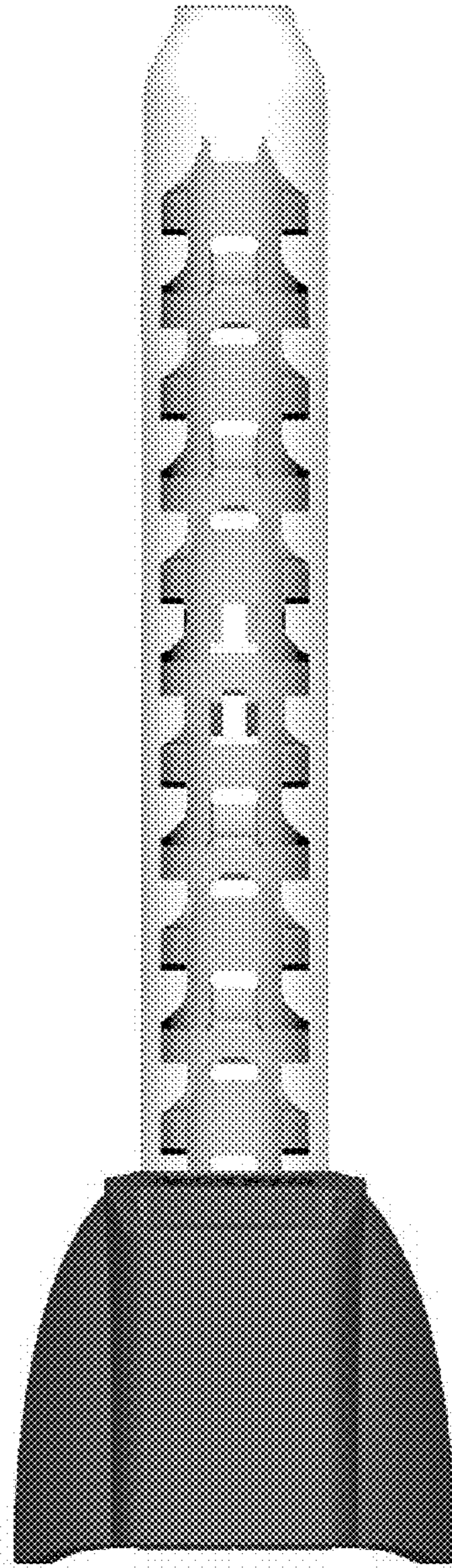

FIG. 5

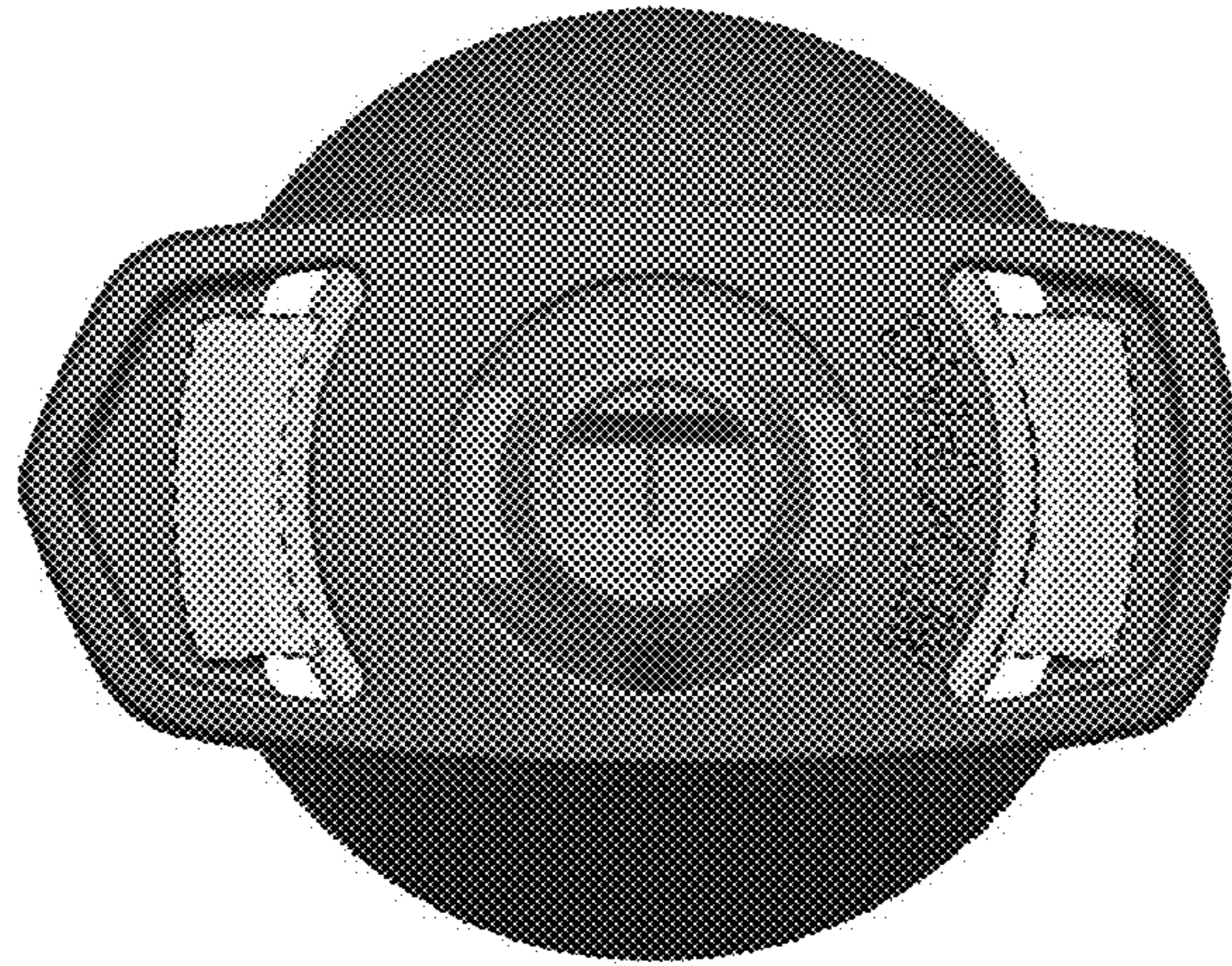

FIG. 6

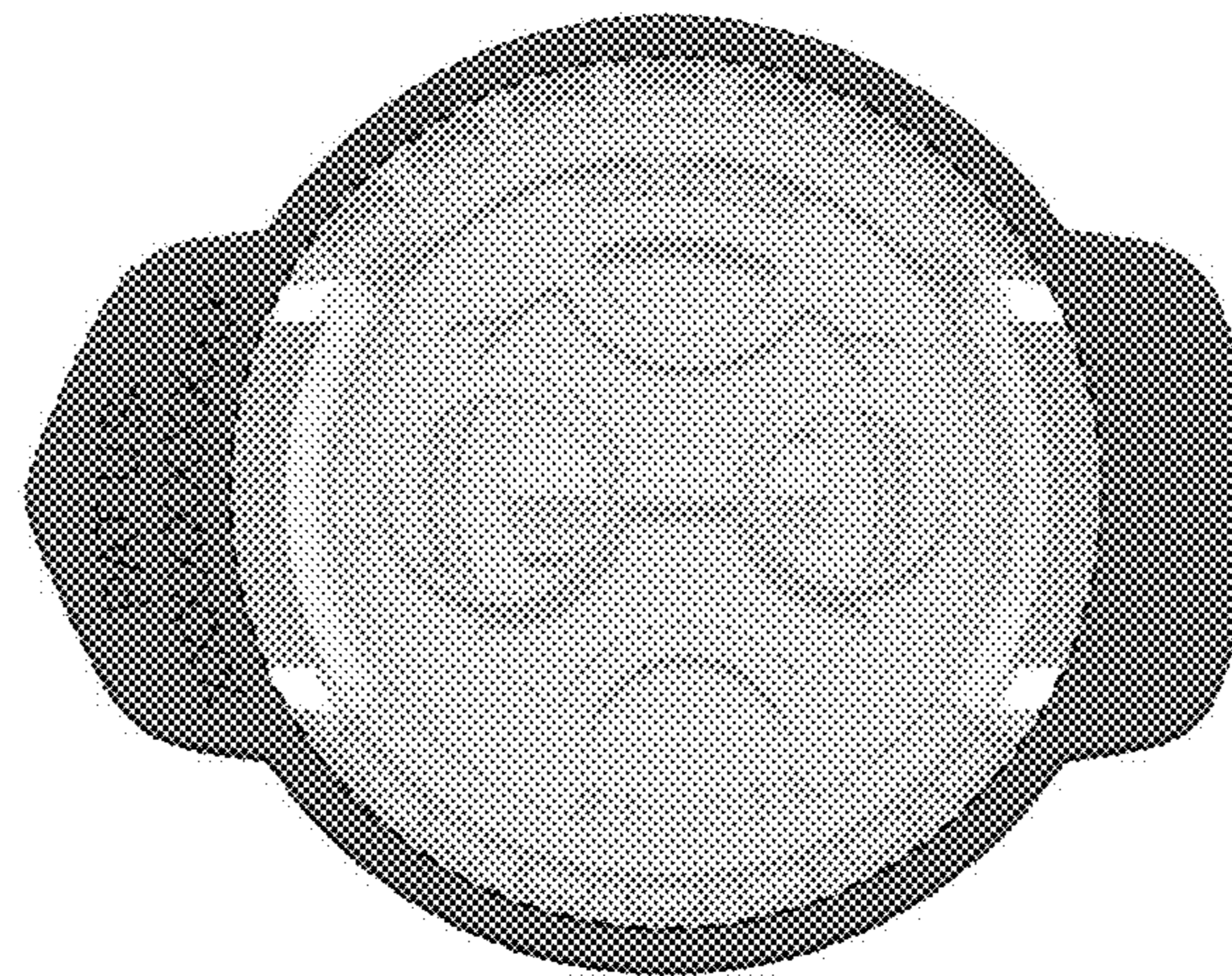

FIG. 7