



US00D611045S

(12) **United States Design Patent**  
**Andre et al.**

(10) **Patent No.:** **US D611,045 S**  
(45) **Date of Patent:** **\*\* Mar. 2, 2010**

(54) **PORTABLE COMPUTER**

(75) Inventors: **Bartley K. Andre**, Menlo Park, CA (US); **Daniel J. Coster**, San Francisco, CA (US); **Daniele De Iuliis**, San Francisco, CA (US); **Evans Hankey**, San Francisco, CA (US); **Richard P. Howarth**, San Francisco, CA (US); **Jonathan P. Ive**, San Francisco, CA (US); **Steve Jobs**, Palo Alto, CA (US); **Duncan Robert Kerr**, San Francisco, CA (US); **Shin Nishibori**, Portola Valley, CA (US); **Matthew Dean Rohrbach**, San Francisco, CA (US); **Peter Russell-Clarke**, San Francisco, CA (US); **Douglas B. Satzger**, Menlo Park, CA (US); **Christopher J. Stringer**, Woodside, CA (US); **Eugene Antony Whang**, San Francisco, CA (US); **Rico Zorkendorfer**, San Francisco, CA (US)

(73) Assignee: **Apple Inc.**, Cupertino, CA (US)

(\*\*) Term: **14 Years**

(21) Appl. No.: **29/342,664**

(22) Filed: **Aug. 28, 2009**

**Related U.S. Application Data**

(60) Division of application No. 29/326,540, filed on Oct. 20, 2008, which is a continuation of application No. 29/326,082, filed on Oct. 10, 2008.

(51) **LOC (9) Cl.** ..... **14-02**

(52) **U.S. Cl.** ..... **D14/327**

(58) **Field of Classification Search** ..... D14/315-328;  
D18/1, 2, 7, 11; 235/145 A, 145 R; 341/22,  
341/23; 455/566; 345/168, 169, 173, 87,  
345/901-905; 361/679.09, 679.27; 718/783;  
400/486, 489

See application file for complete search history.

(56) **References Cited**

U.S. PATENT DOCUMENTS

6,067,224	A *	5/2000	Nobuchi	.....	361/679.27
D431,821	S *	10/2000	Mizuno	.....	D14/318
D463,797	S	10/2002	Andre et al.		
D491,177	S	6/2004	Andre et al.		
D493,785	S	8/2004	Andre et al.		
D504,889	S	5/2005	Andre et al.		
D517,063	S *	3/2006	Nakajima et al.	.....	D14/318
D523,429	S *	6/2006	Lin	.....	D14/318
D524,306	S *	7/2006	Yun et al.	.....	D14/315
D526,999	S *	8/2006	Tago	.....	D14/327
D533,550	S *	12/2006	Yamada	.....	D14/318
D558,752	S	1/2008	Andre et al.		
D558,753	S	1/2008	Andre et al.		
D571,364	S	6/2008	Andre et al.		
D572,246	S *	7/2008	Andre et al.	.....	D14/315
D572,247	S *	7/2008	Andre et al.	.....	D14/315
D574,378	S *	8/2008	Andre et al.	.....	D14/315
2005/0018396	A1 *	1/2005	Nakajima et al.	.....	361/683
2005/0041378	A1 *	2/2005	Hamada et al.	.....	361/680

OTHER PUBLICATIONS

Photographs of Sony VAIO PCG-4G1L, available at least as early as May 8, 2006.

Apple MacBook Air, available Jan. 15, 2008, [http://images.apple.com/macbookair/images/design\\_gal01\\_20080115.jpg](http://images.apple.com/macbookair/images/design_gal01_20080115.jpg).

Apple MacBook Air, available Jan. 15, 2008, [http://images.apple.com/macbookair/images/design\\_gal02\\_20080115.jpg](http://images.apple.com/macbookair/images/design_gal02_20080115.jpg).

Apple MacBook Air, available Jan. 15, 2008, [http://images.apple.com/macbookair/images/design\\_gal03\\_20080115.jpg](http://images.apple.com/macbookair/images/design_gal03_20080115.jpg).

Apple MacBook Air, available Jan. 15, 2008, [http://images.apple.com/macbookair/images/design\\_gal04\\_20080115.jpg](http://images.apple.com/macbookair/images/design_gal04_20080115.jpg).

Apple MacBook Air, available Jan. 15, 2008, [http://images.apple.com/macbookair/images/design\\_thinair20080115.jpg](http://images.apple.com/macbookair/images/design_thinair20080115.jpg).

Apple MacBook Air, available Jan. 15, 2008, [http://images.apple.com/macbookair/images/design\\_displayair20080115.jpg](http://images.apple.com/macbookair/images/design_displayair20080115.jpg).

Apple MacBook Air, available Jan. 15, 2008, [http://images.apple.com/macbookair/images/design\\_keyboardair20080115.jpg](http://images.apple.com/macbookair/images/design_keyboardair20080115.jpg).

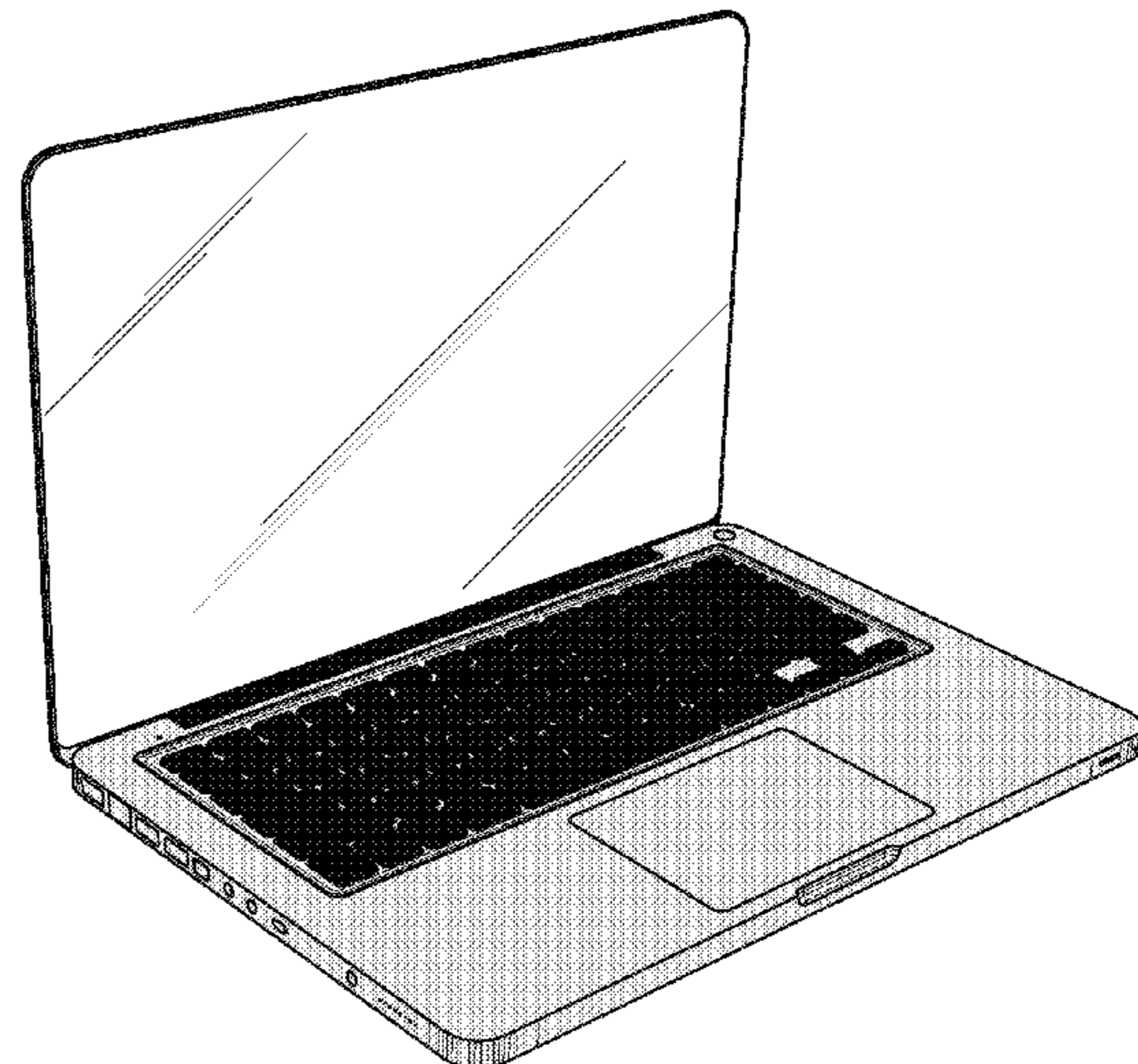
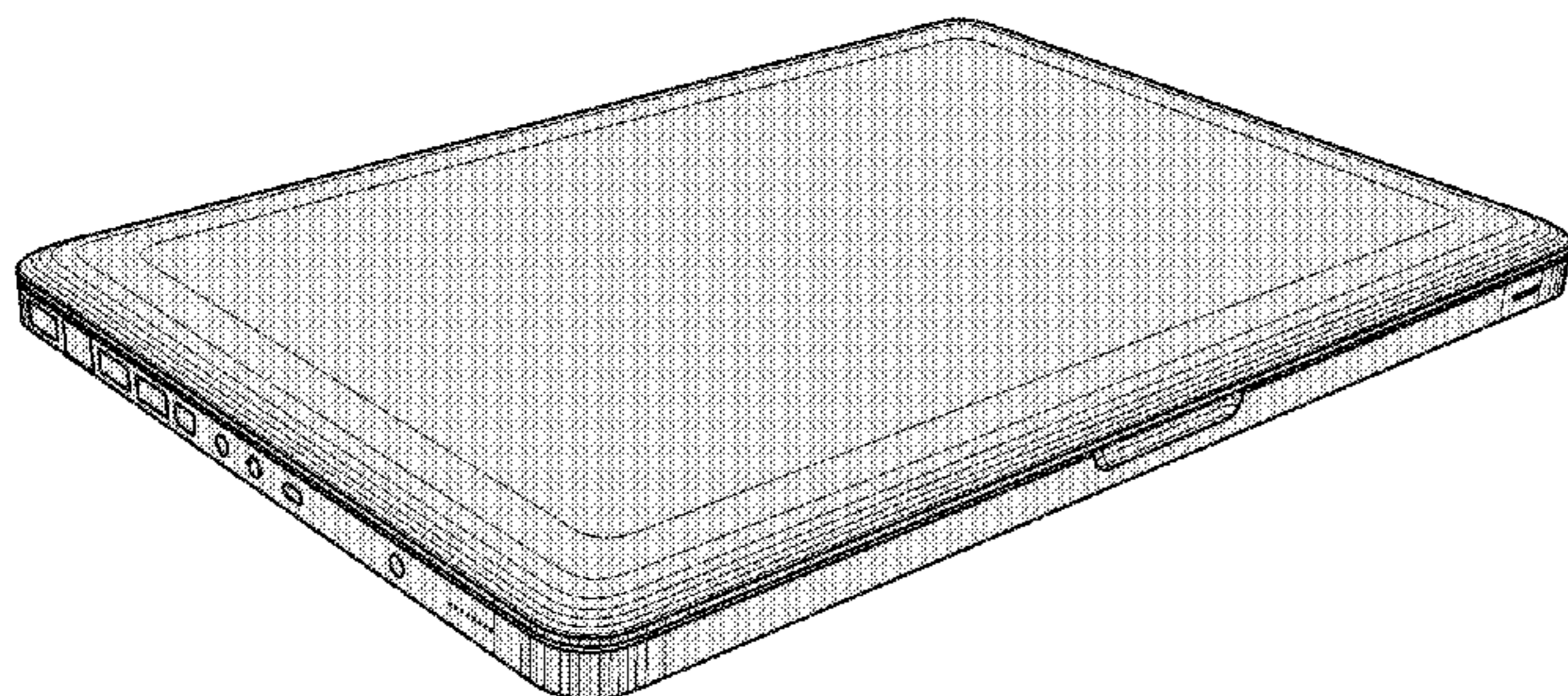

Apple MacBook Air, available Jan. 15, 2008, [http://images.apple.com/macbookair/images/design\\_gal08\\_20080115.jpg](http://images.apple.com/macbookair/images/design_gal08_20080115.jpg).

\* cited by examiner

*Primary Examiner*—Freda S Nunn  
*(74) Attorney, Agent, or Firm*—Saidman DesignLaw Group

(57) **CLAIM**

The ornamental design for a portable computer, as shown and described.

**DESCRIPTION**

FIG. 1 is a front, top perspective view of a first embodiment of a portable computer showing our new design;

FIG. 2 is front view thereof;

FIG. 3 is a rear view thereof;

FIG. 4 is a left side view thereof;

FIG. 5 is a right side view thereof;

FIG. 6 is a top view thereof;

FIG. 7 is a bottom view thereof;

FIG. 8 is a bottom front perspective view thereof;

FIG. 9 is a second bottom front perspective view thereof with a latch in an open position;

FIG. 10 is a front, top perspective view thereof, with the portable computer shown in an open position;

FIG. 11 is a front view thereof;

FIG. 12 is a left rear view thereof;

FIG. 13 is a left side view thereof;

FIG. 14 is a right side view thereof;

FIG. 15 is a top view thereof;

FIG. 16 is a bottom view thereof;

FIG. 17 is a front, bottom perspective view thereof;

FIG. 18 is a front, top perspective view of a second embodiment showing our new design;

FIG. 19 is front view thereof;

FIG. 20 is a rear view thereof;

FIG. 21 is a left side view thereof;

FIG. 22 is a right side view thereof;

FIG. 23 is a top view thereof;

FIG. 24 is a bottom view thereof;

FIG. 25 is a bottom, front perspective view thereof;

FIG. 26 is a front, top perspective view thereof, with the portable computer shown in an open position;

FIG. 27 is a front view thereof;

FIG. 28 is a left rear view thereof;

FIG. 29 is a left side view thereof;

FIG. 30 is a right side view thereof;

FIG. 31 is a top view thereof;

FIG. 32 is a bottom view thereof;

FIG. 33 is a front, bottom perspective view thereof;

FIG. 34 is a front, top perspective view of a third embodiment showing our new design;

FIG. 35 is front view thereof;

FIG. 36 is a rear view thereof;

FIG. 37 is a left side view thereof;

FIG. 38 is a right side view thereof;

FIG. 39 is a top view thereof;

FIG. 40 is a bottom view thereof;

FIG. 41 is a bottom, front perspective view thereof;

FIG. 42 is a front, top perspective view thereof, with the portable computer shown in an open position;

FIG. 43 is a front view thereof;

FIG. 44 is a left rear view thereof;

FIG. 45 is a left side view thereof;

FIG. 46 is a right side view thereof;

FIG. 47 is a top view thereof;

FIG. 48 is a bottom view thereof; and,

FIG. 49 is a front, bottom perspective view thereof.

The claimed design is shown in relatively bold lines. In some embodiments, certain portions of the design, such as the hinge, keys and feet, may be black. The portion of the portable computer shown in gray shading represents a metallic-looking surface that preferably contrasts with the black portions. The relatively thin shade lines show contour and not surface ornamentation. The parallel diagonal shade lines represent a translucent surface. All broken lines represent environmental subject matter that forms no part of the claimed design.

**1 Claim, 40 Drawing Sheets**

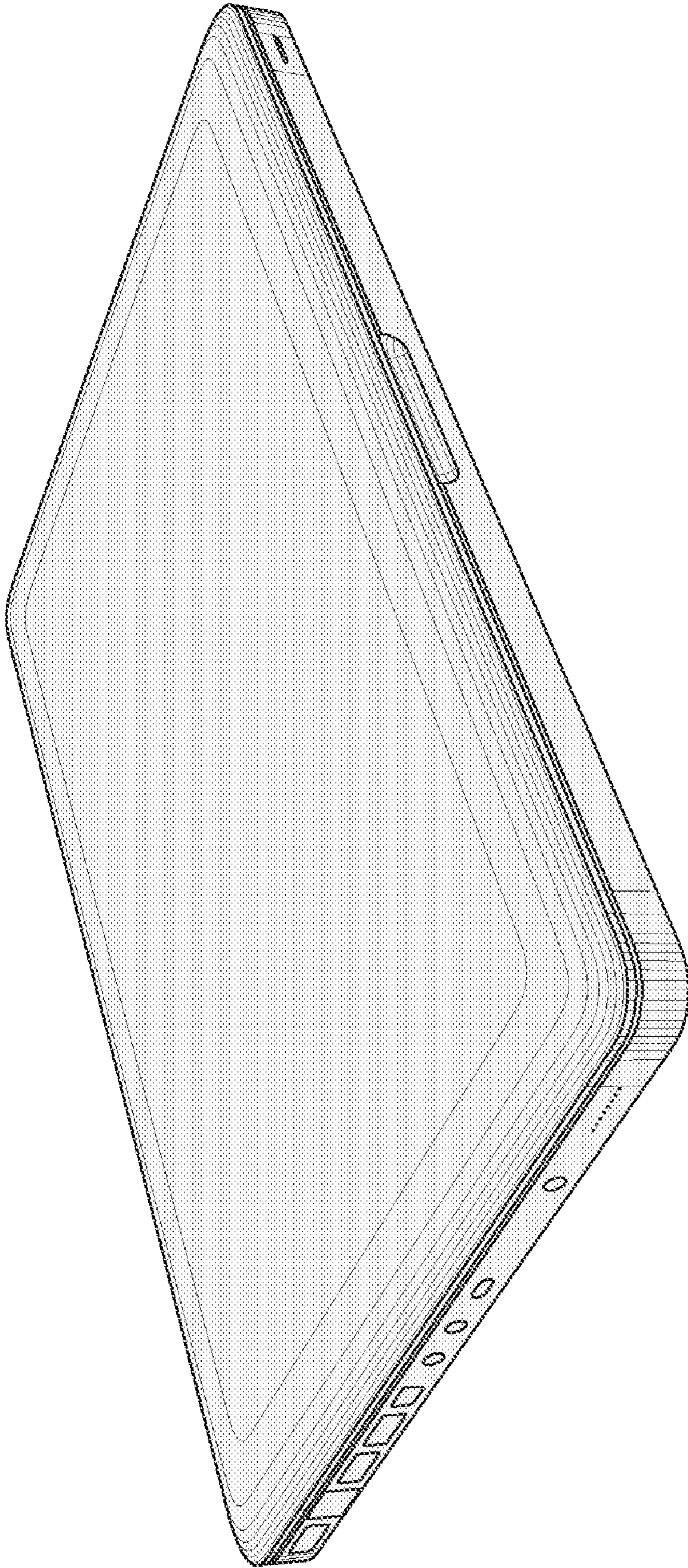
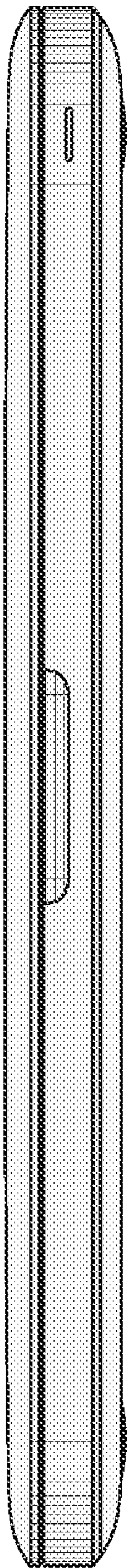
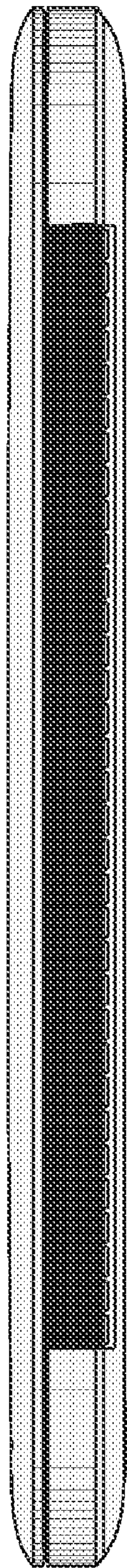

Fig. 1



**Fig. 2**



**Fig. 3**

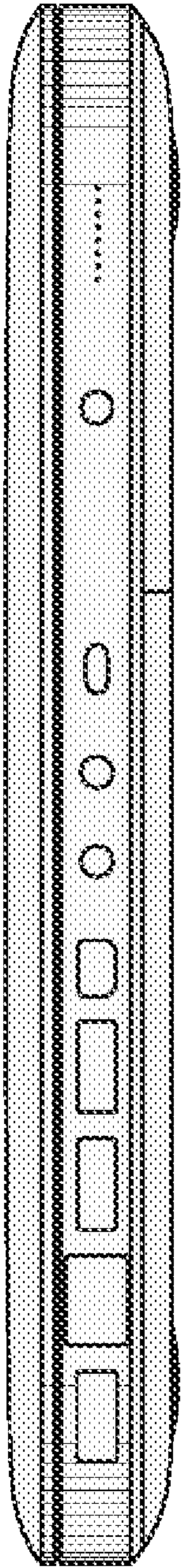

*Fig. 4*

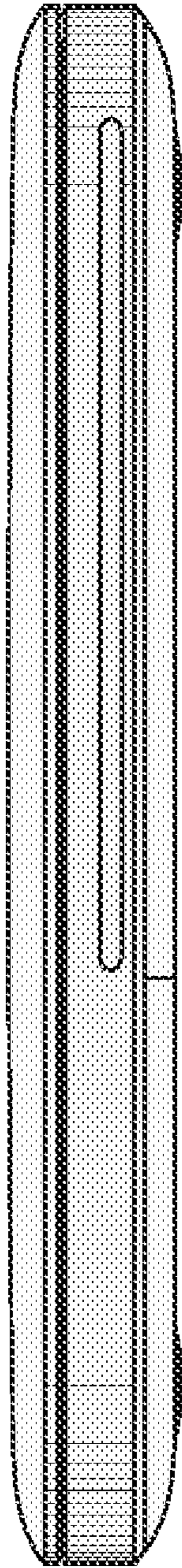

*Fig. 5*

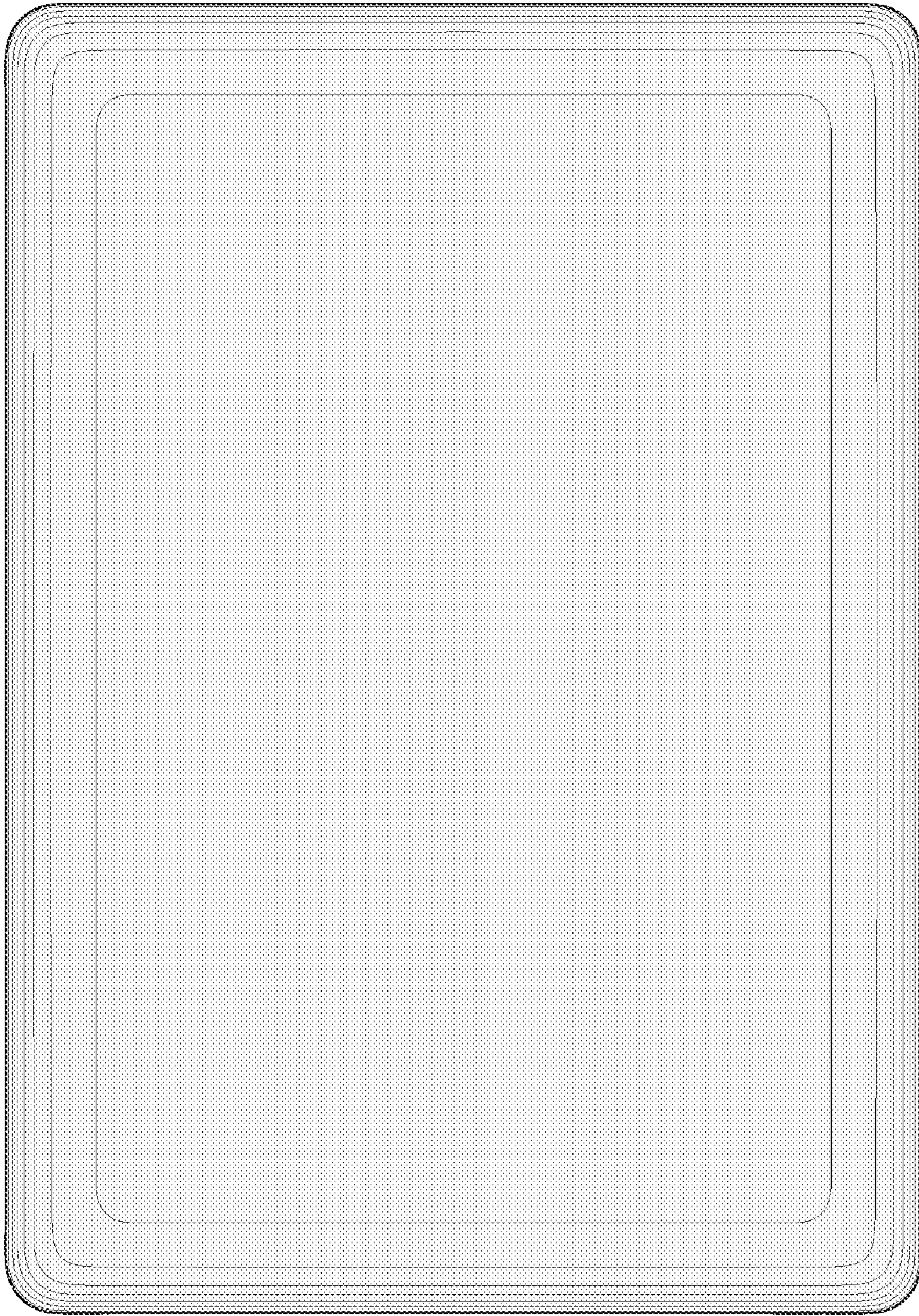

Fig. 6

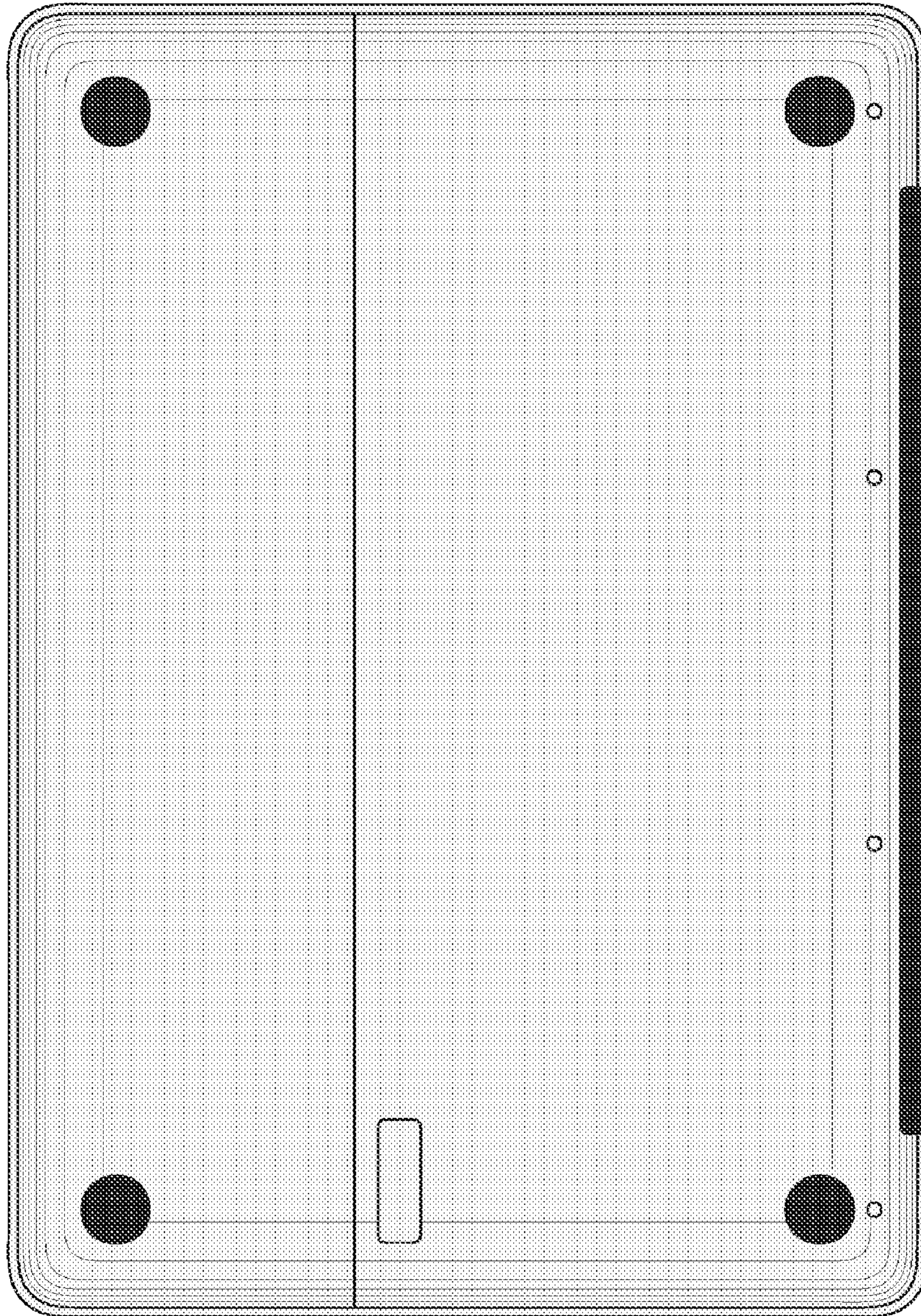

Fig. 7

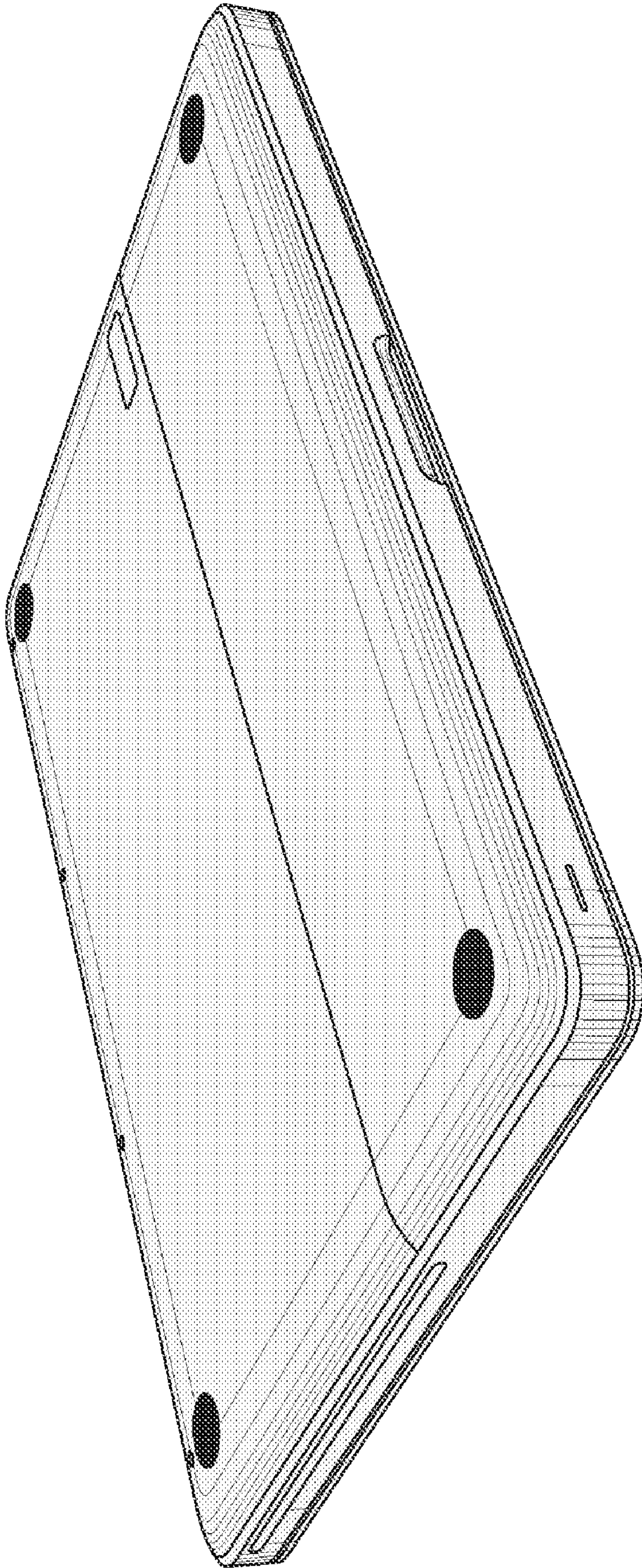

Fig. 8



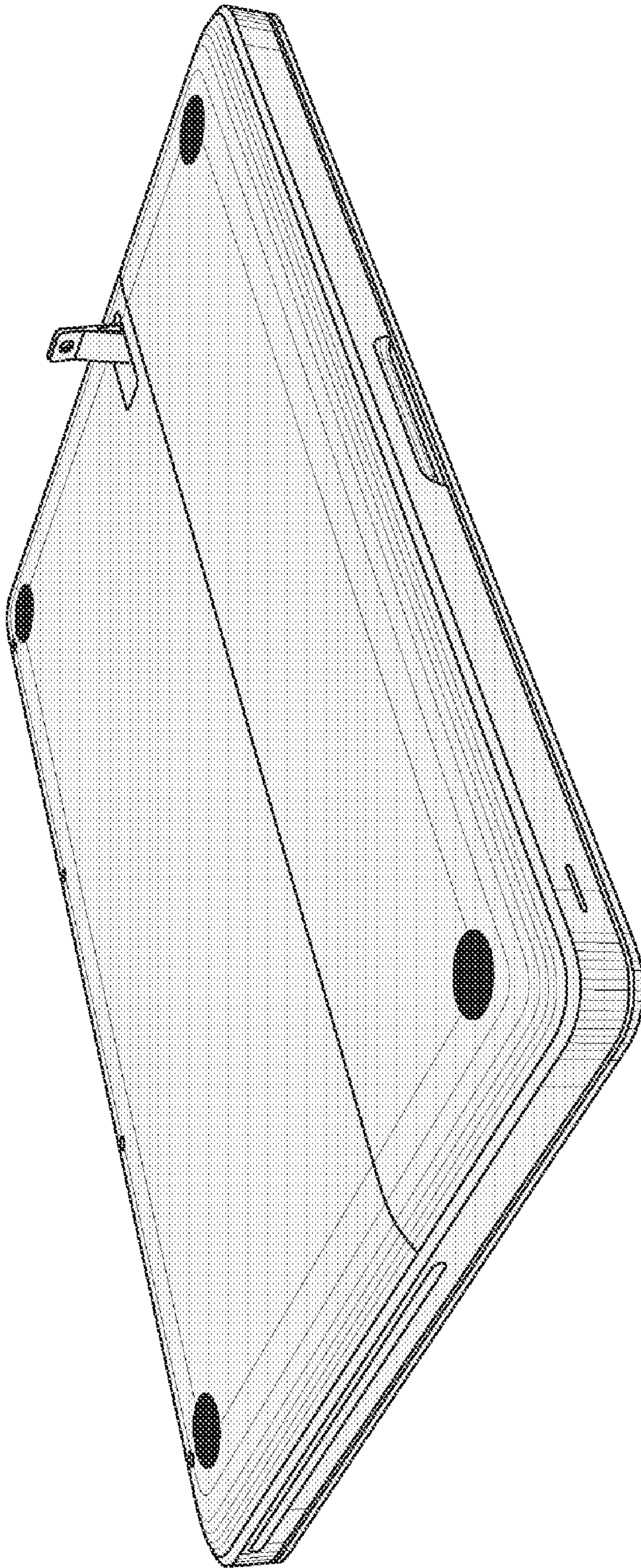

Fig. 9

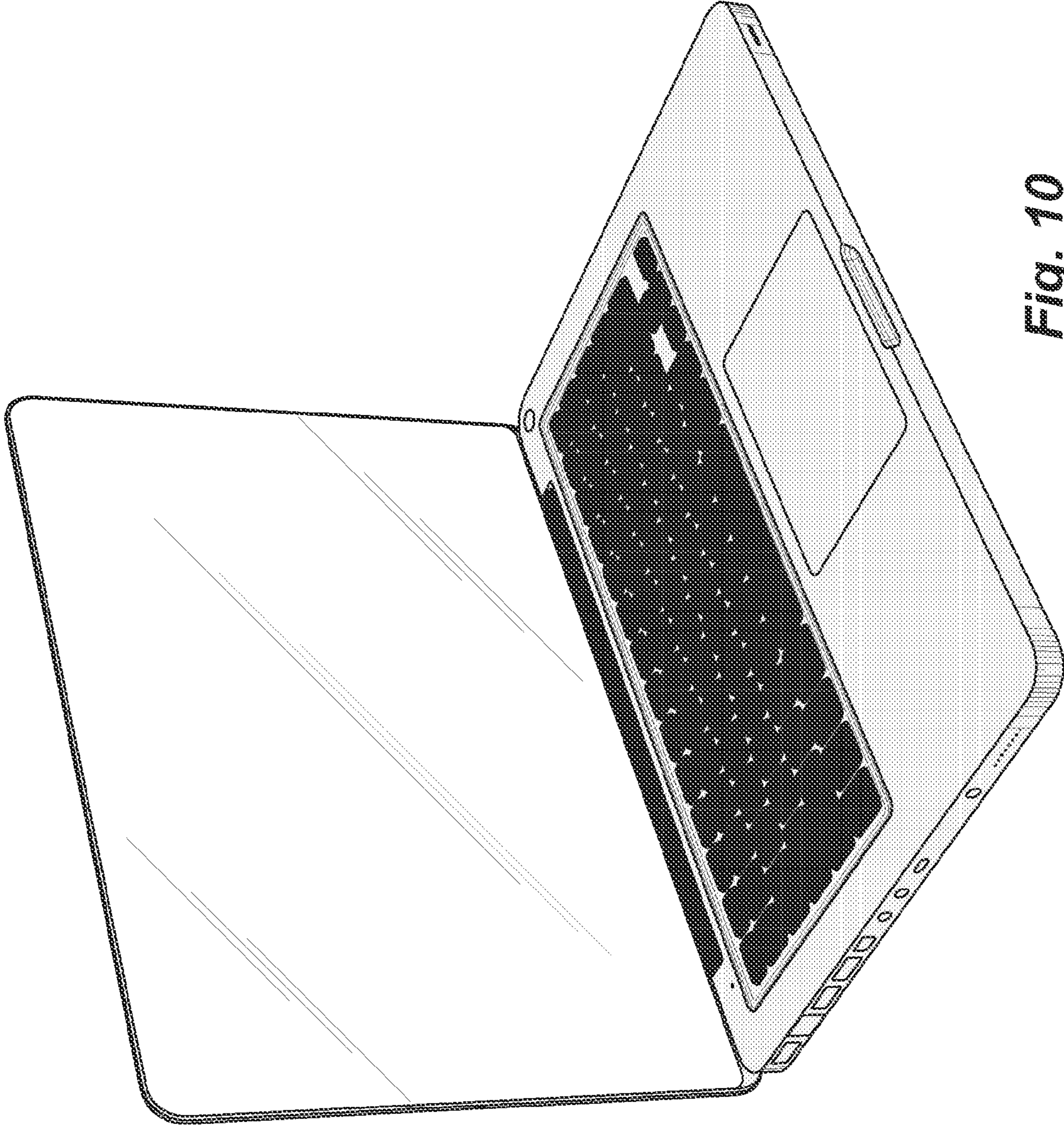
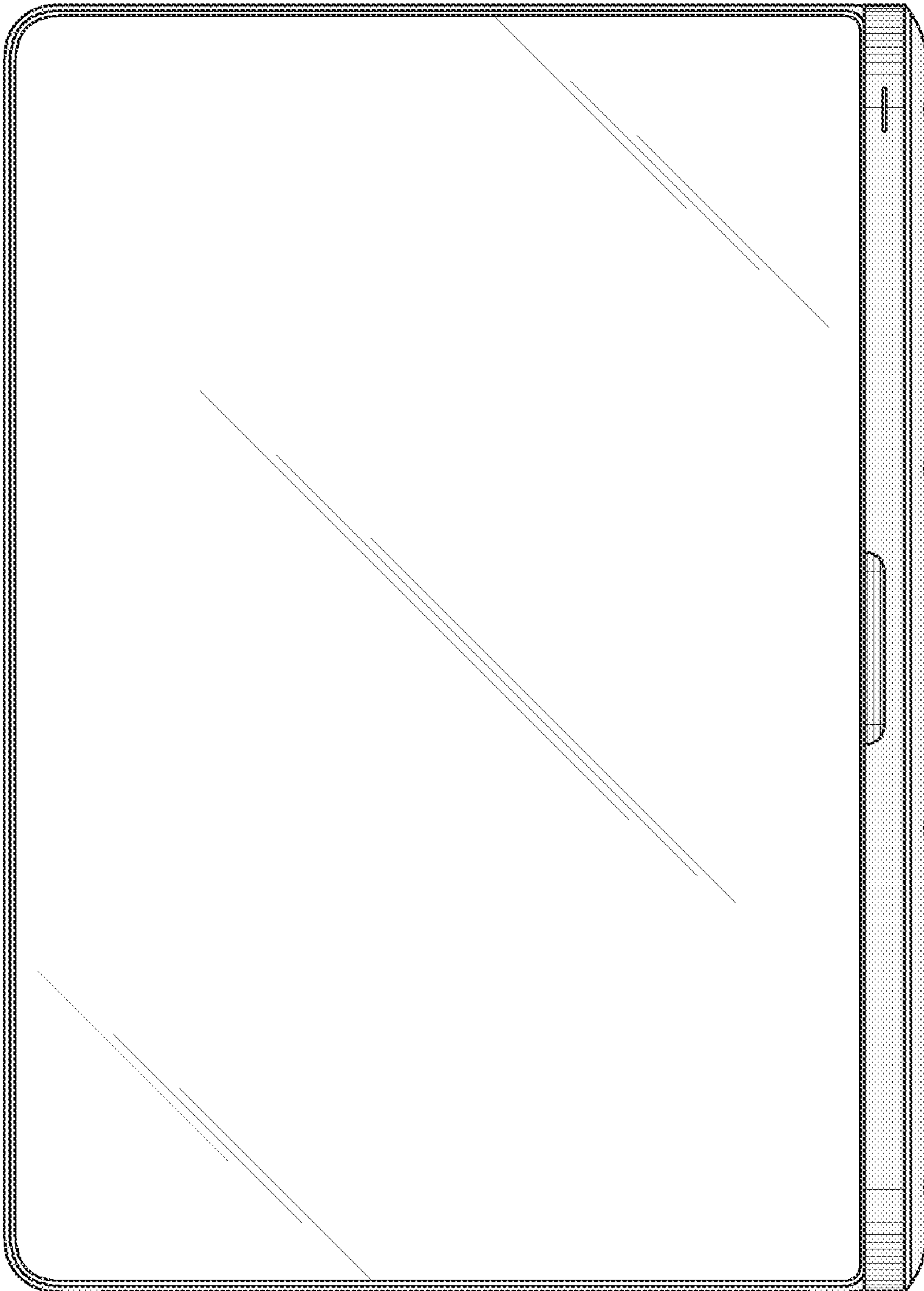
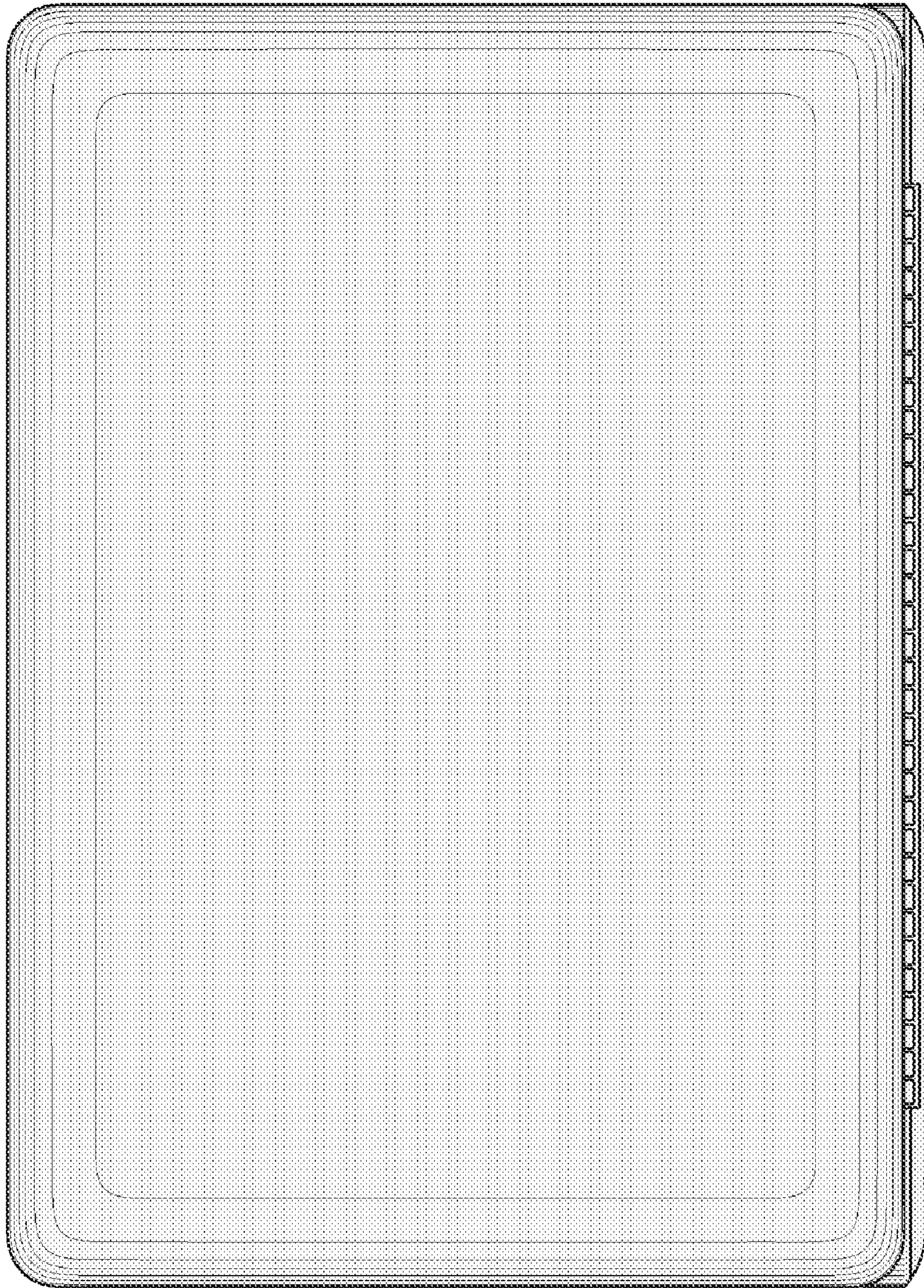

Fig. 10



**Fig. 11**



**Fig. 12**

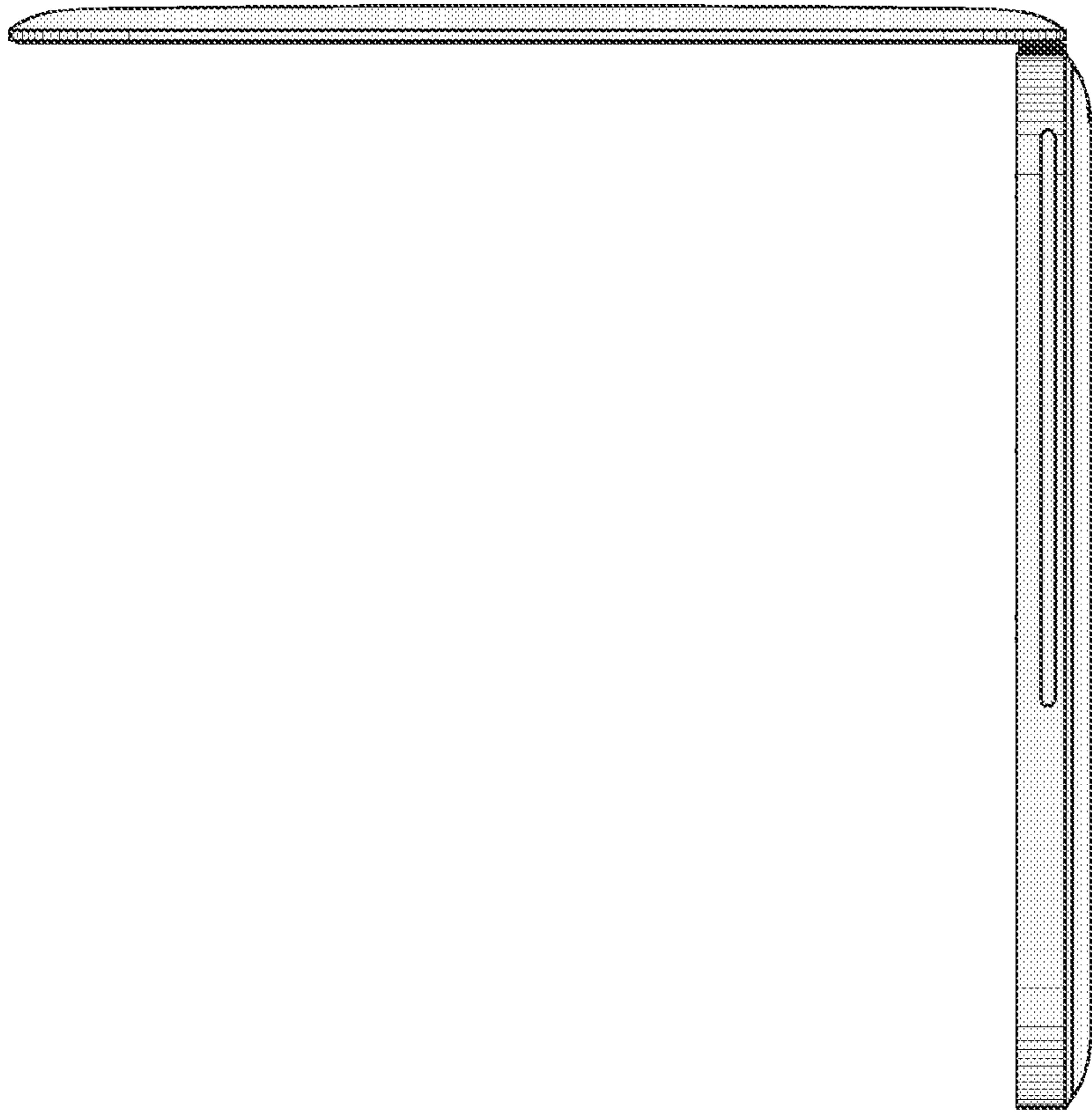

Fig. 14

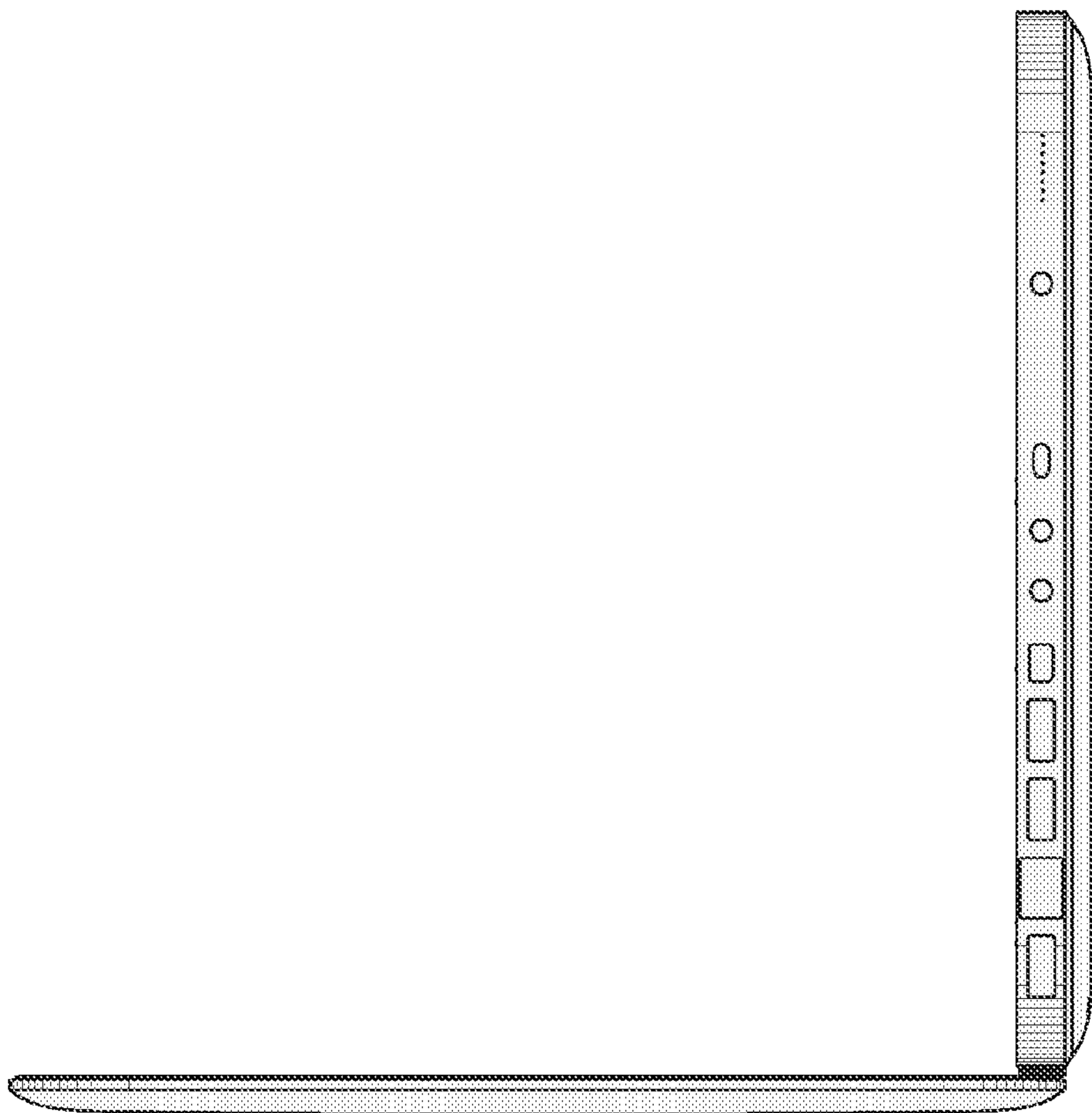

Fig. 13

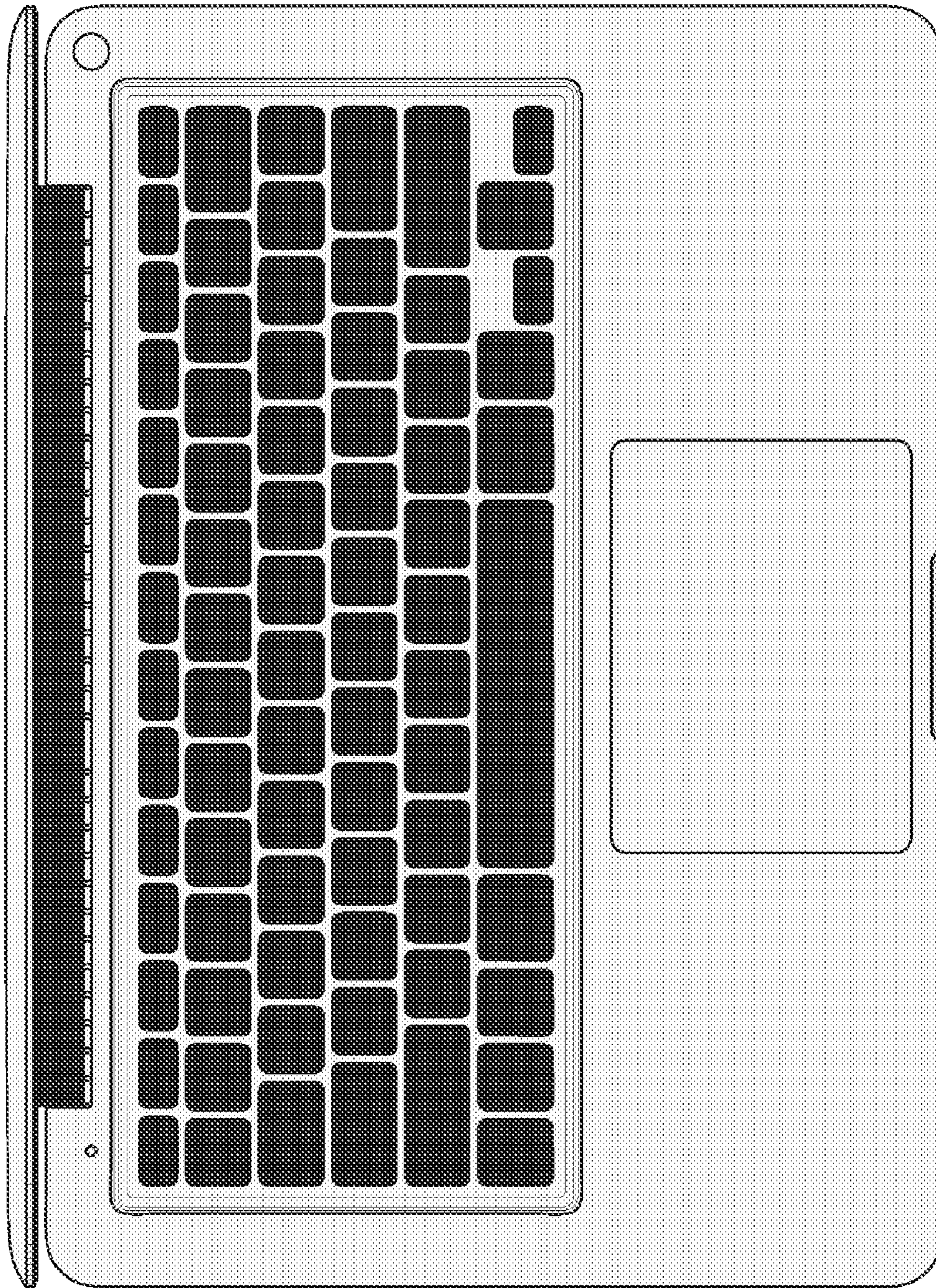

Fig. 15

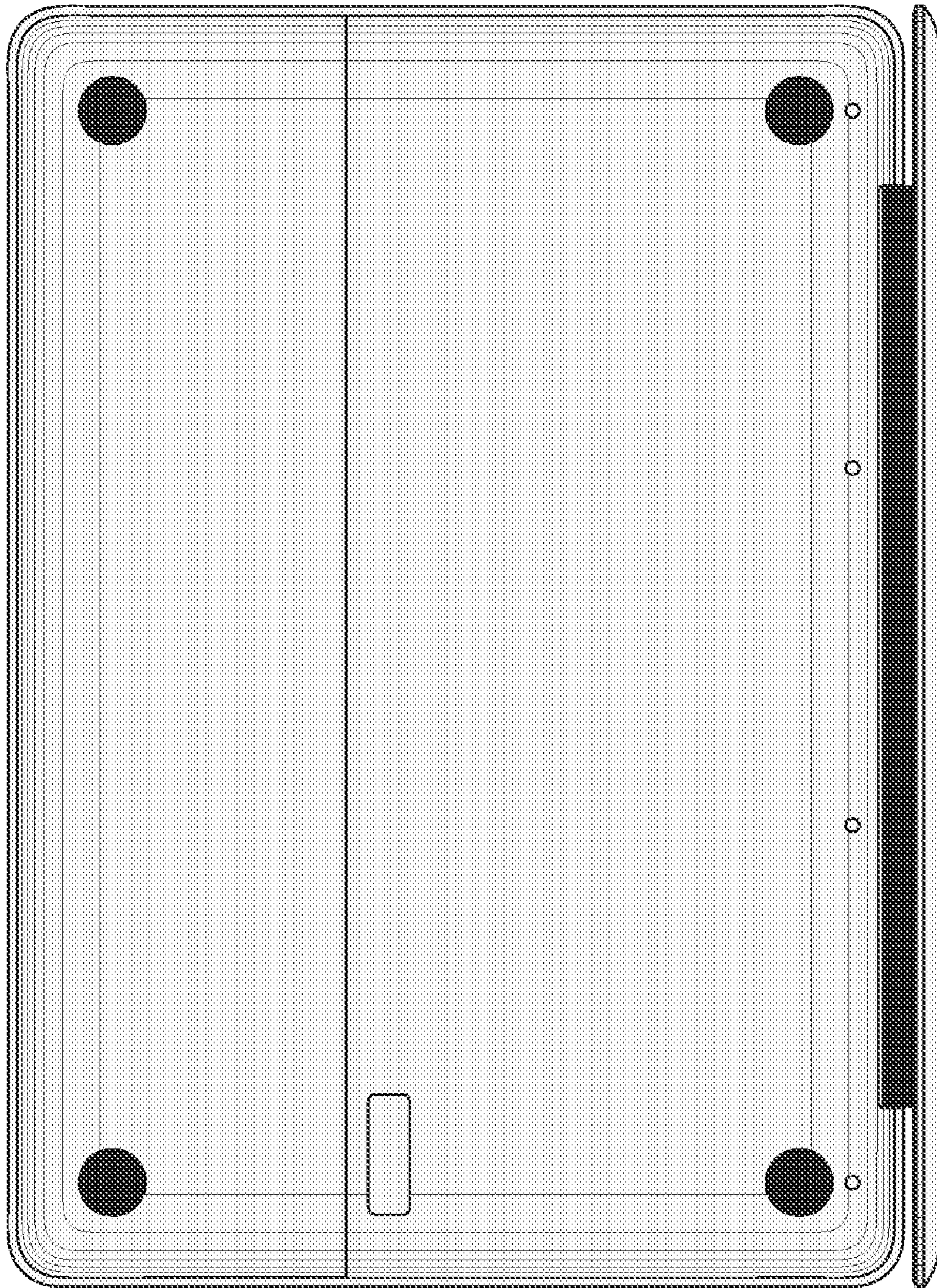

Fig. 16

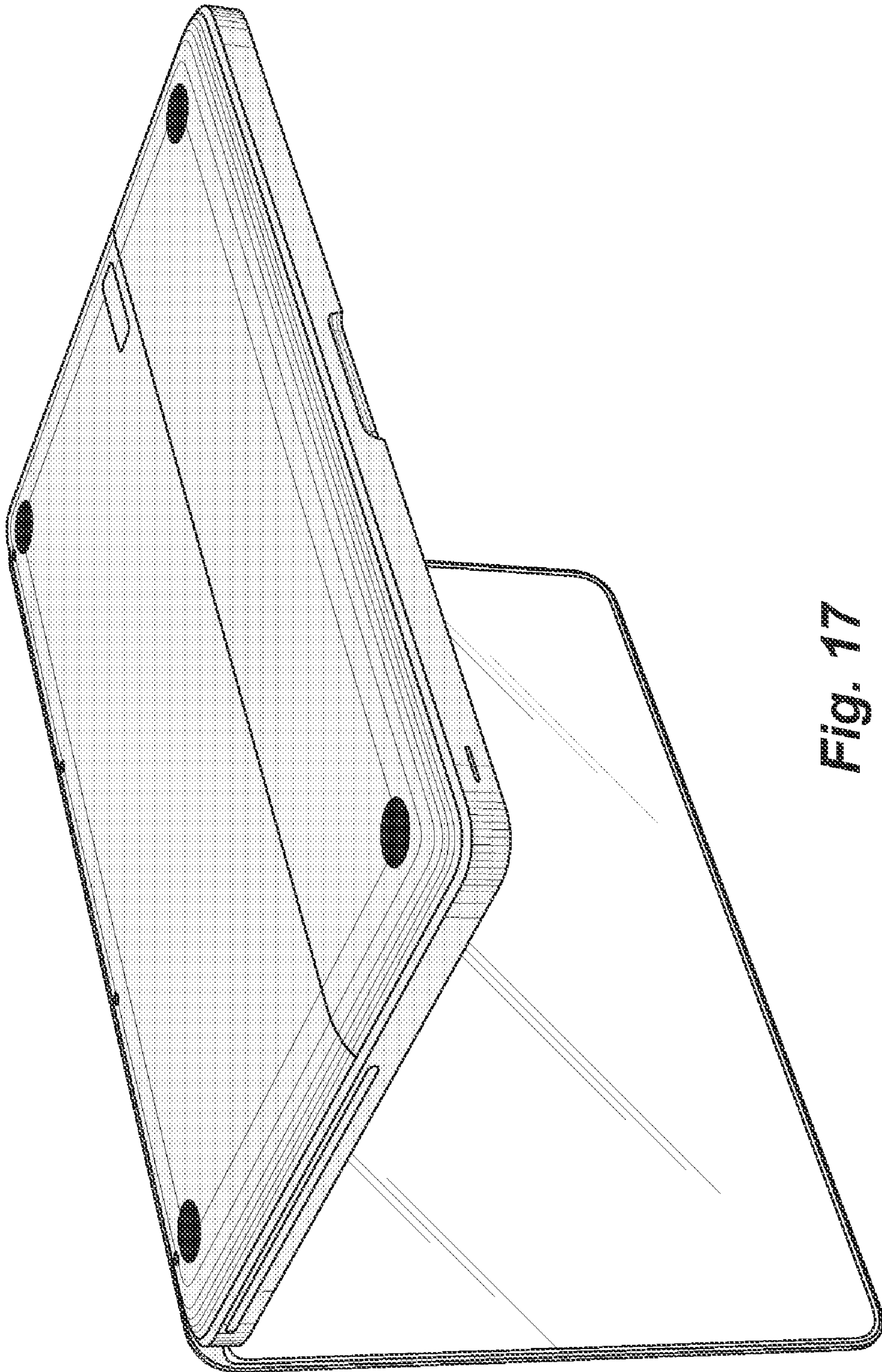

Fig. 17



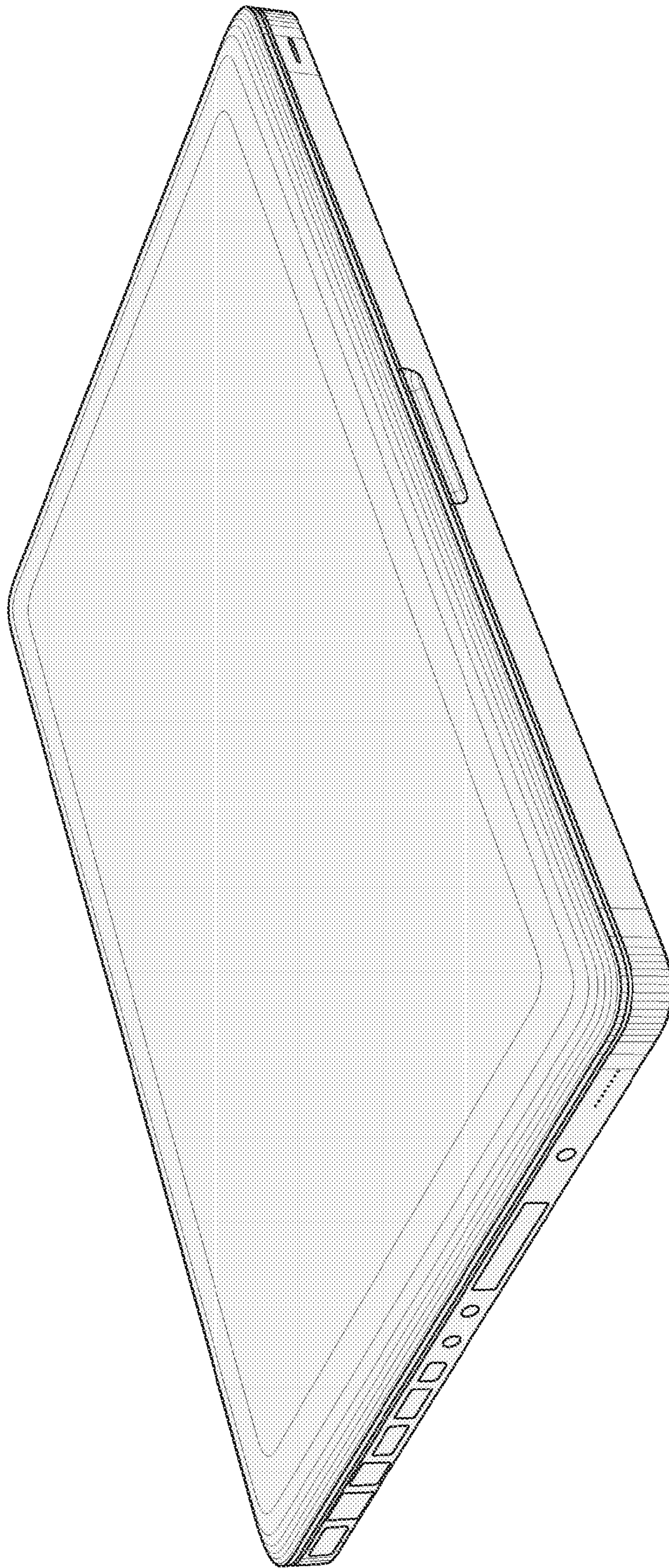
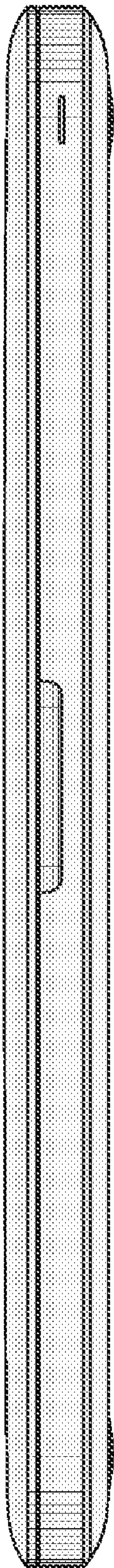
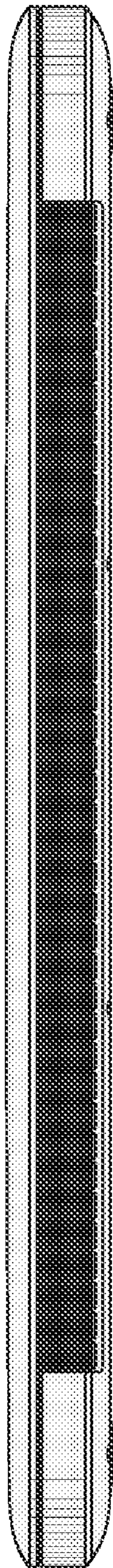

Fig. 18



*Fig. 19*



*Fig. 20*

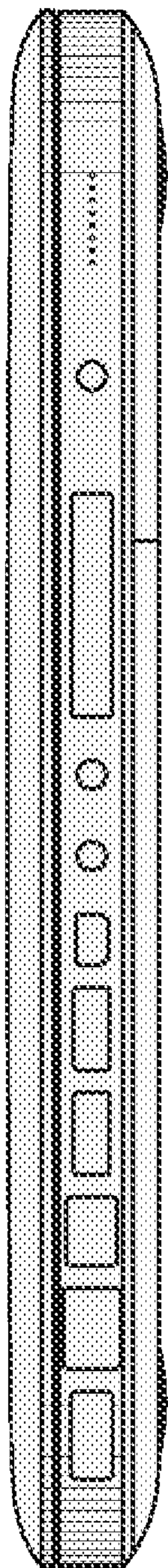

**Fig. 21**

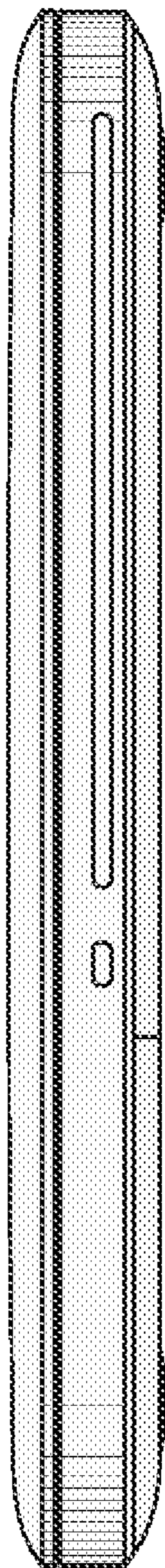

**Fig. 22**

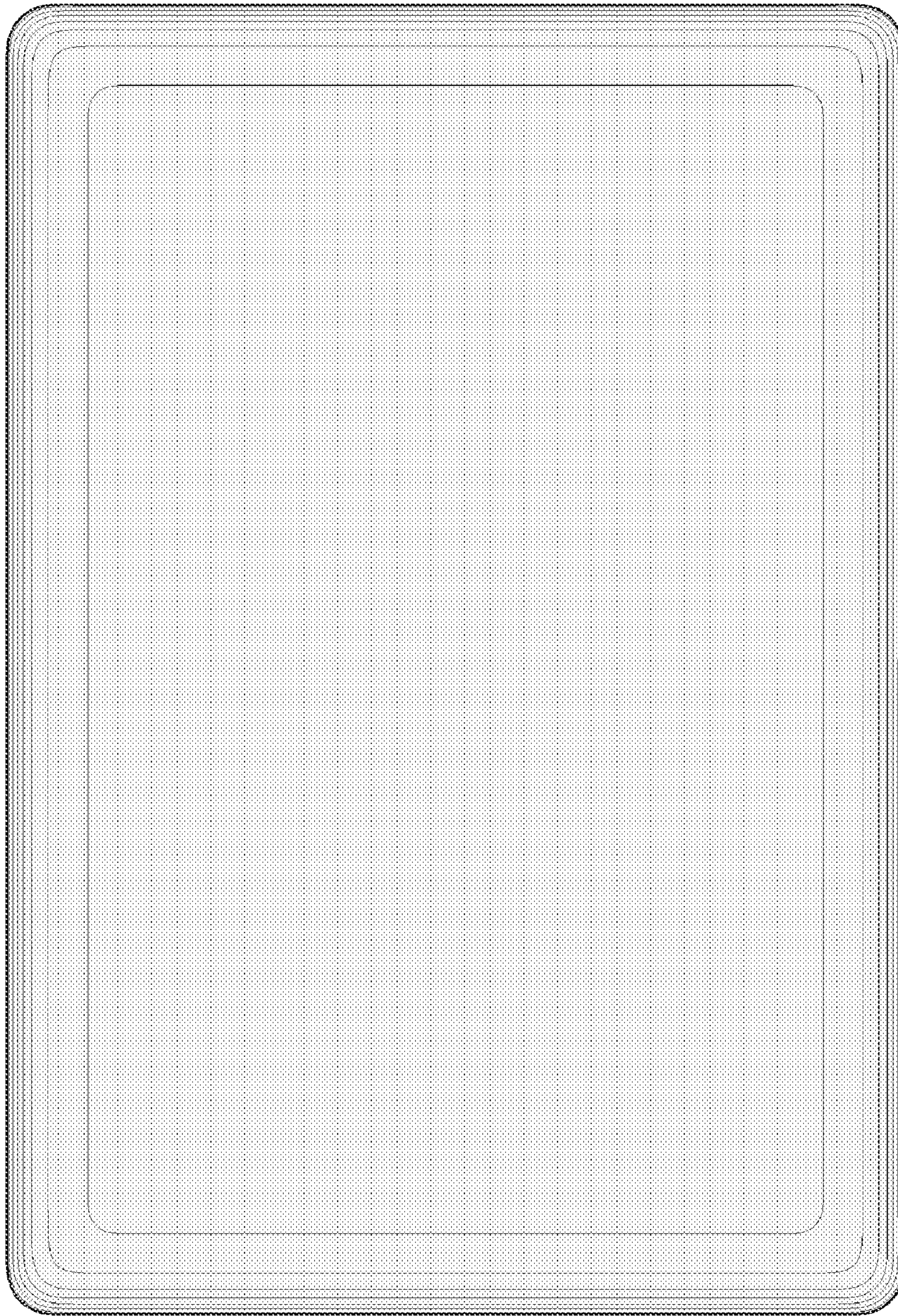

**Fig. 23**

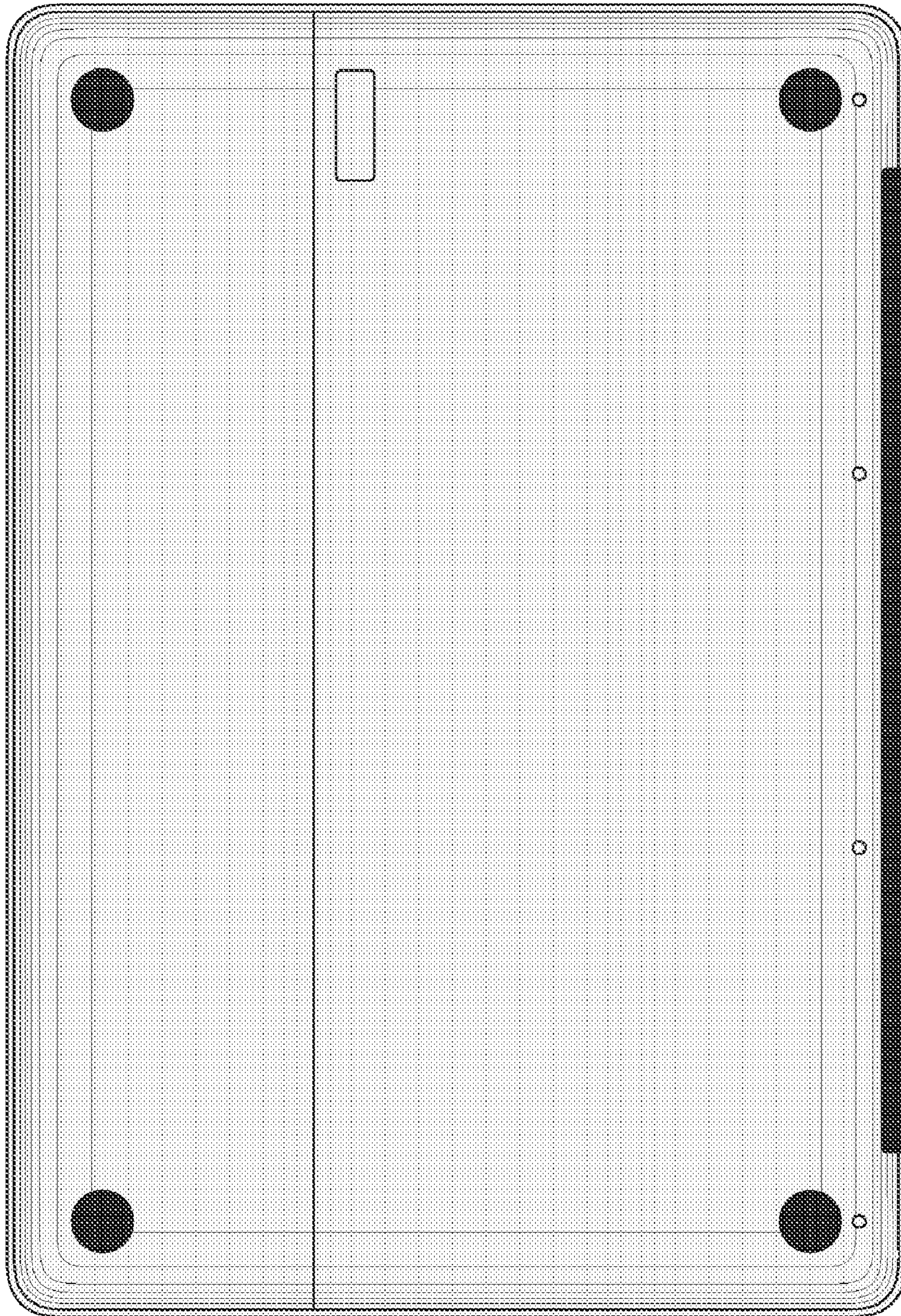

Fig. 24

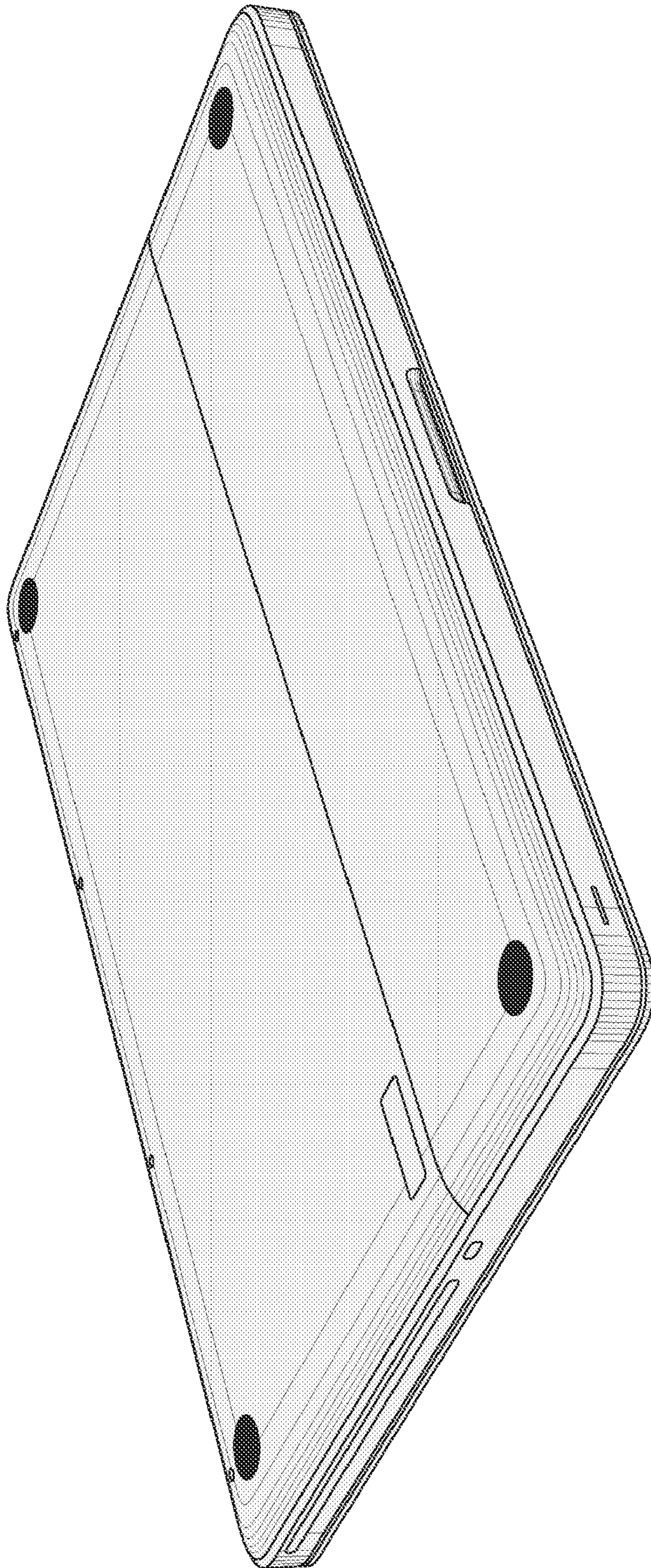

Fig. 25

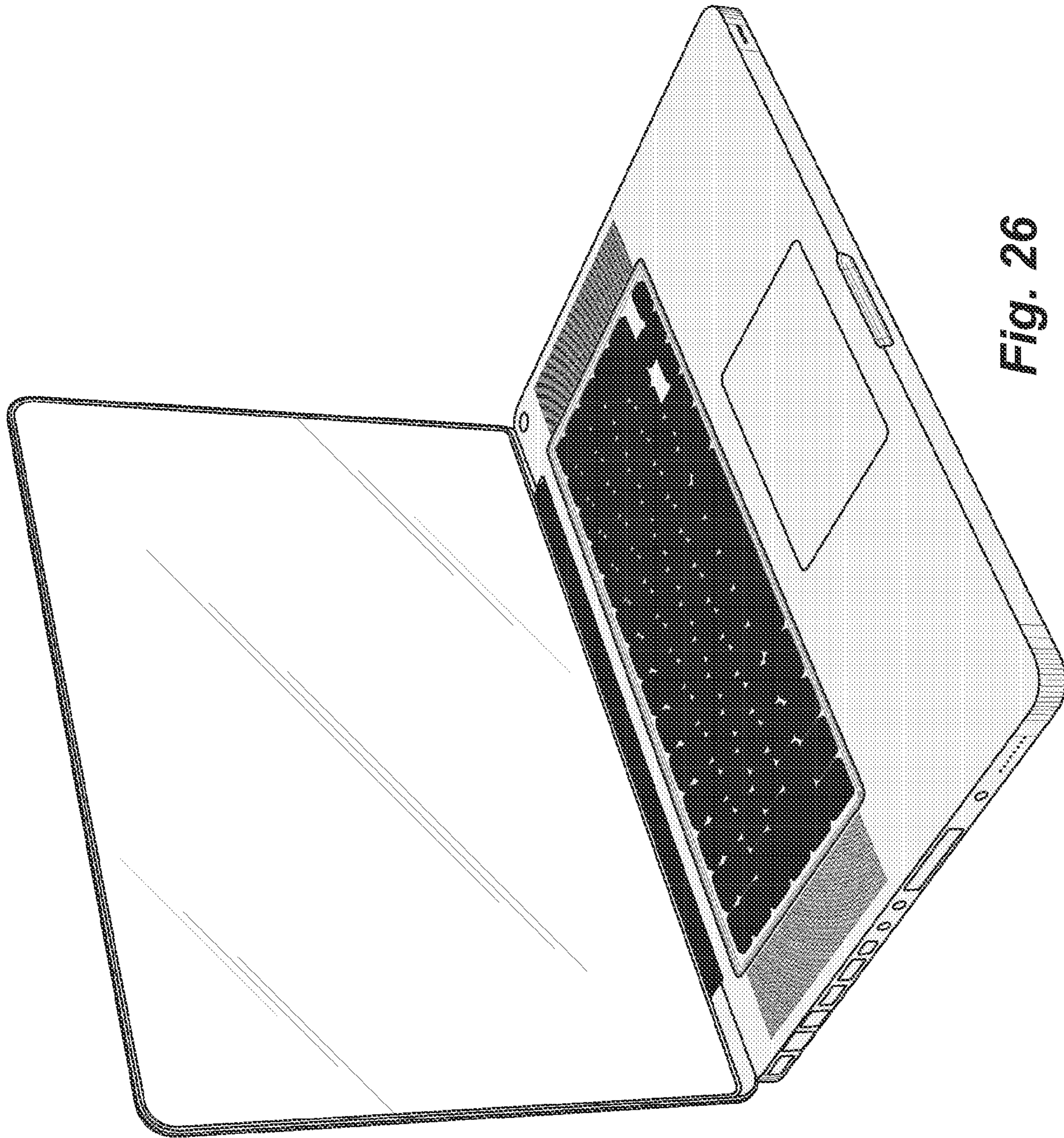

Fig. 26

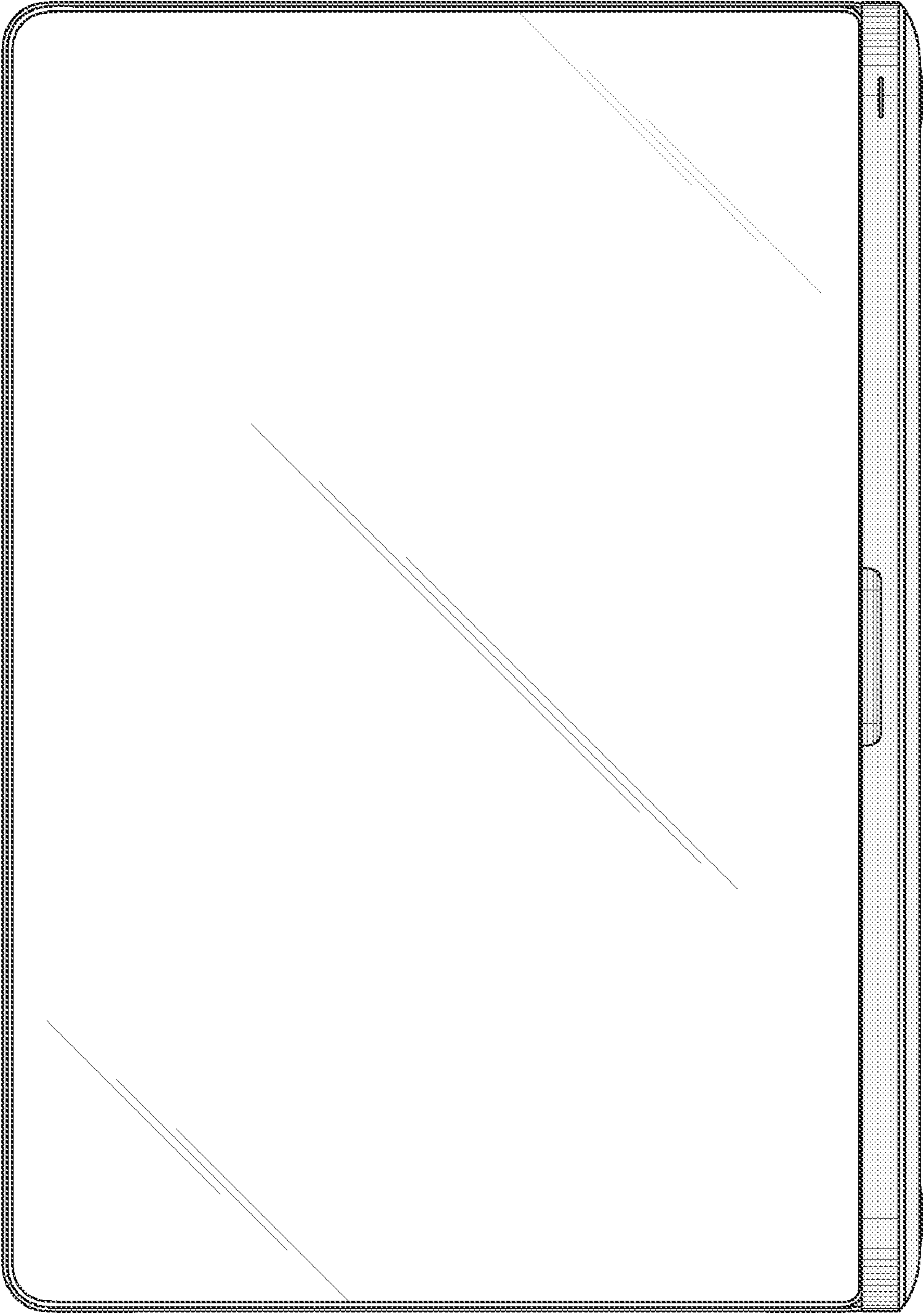
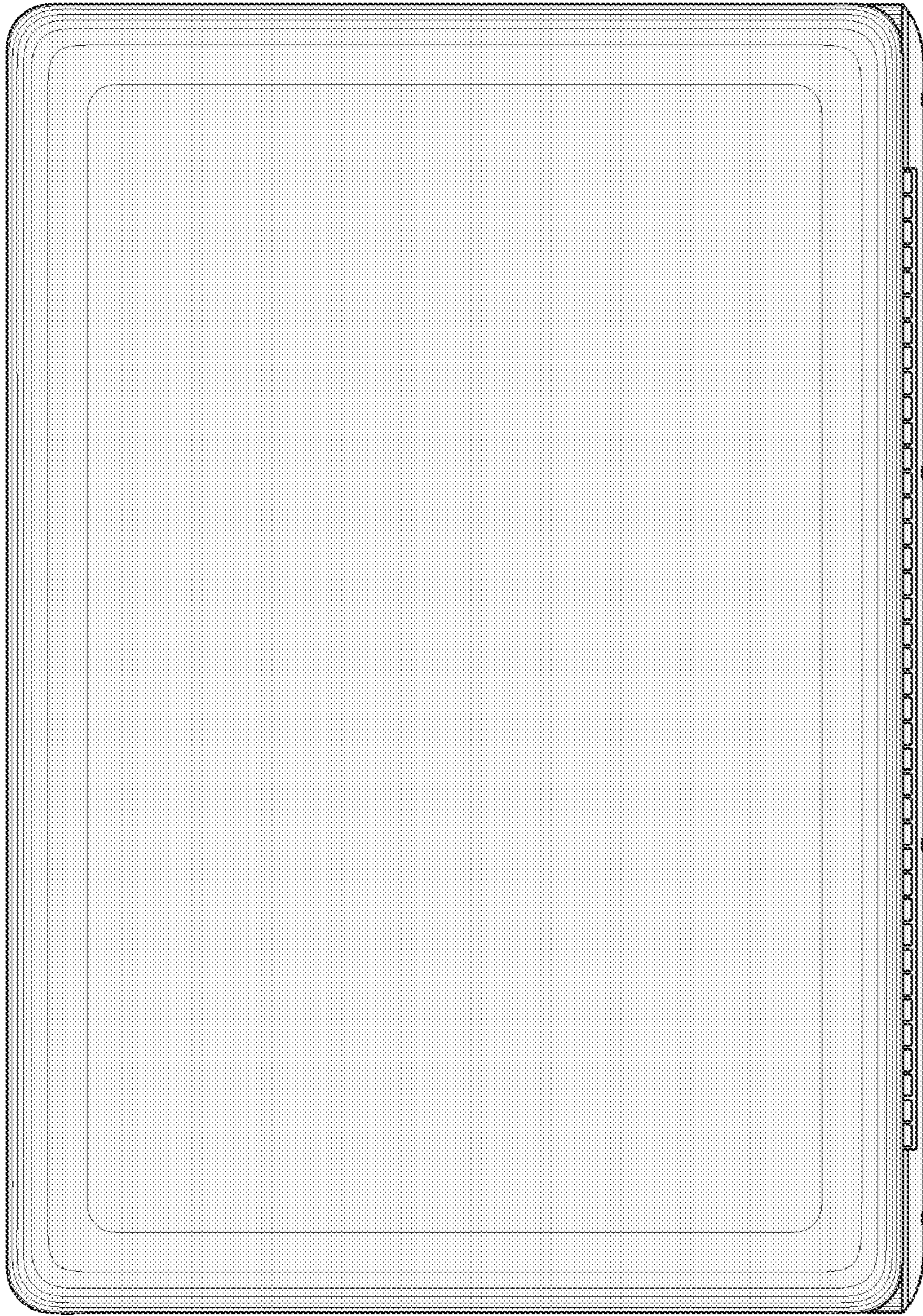

Fig. 27





**Fig. 28**

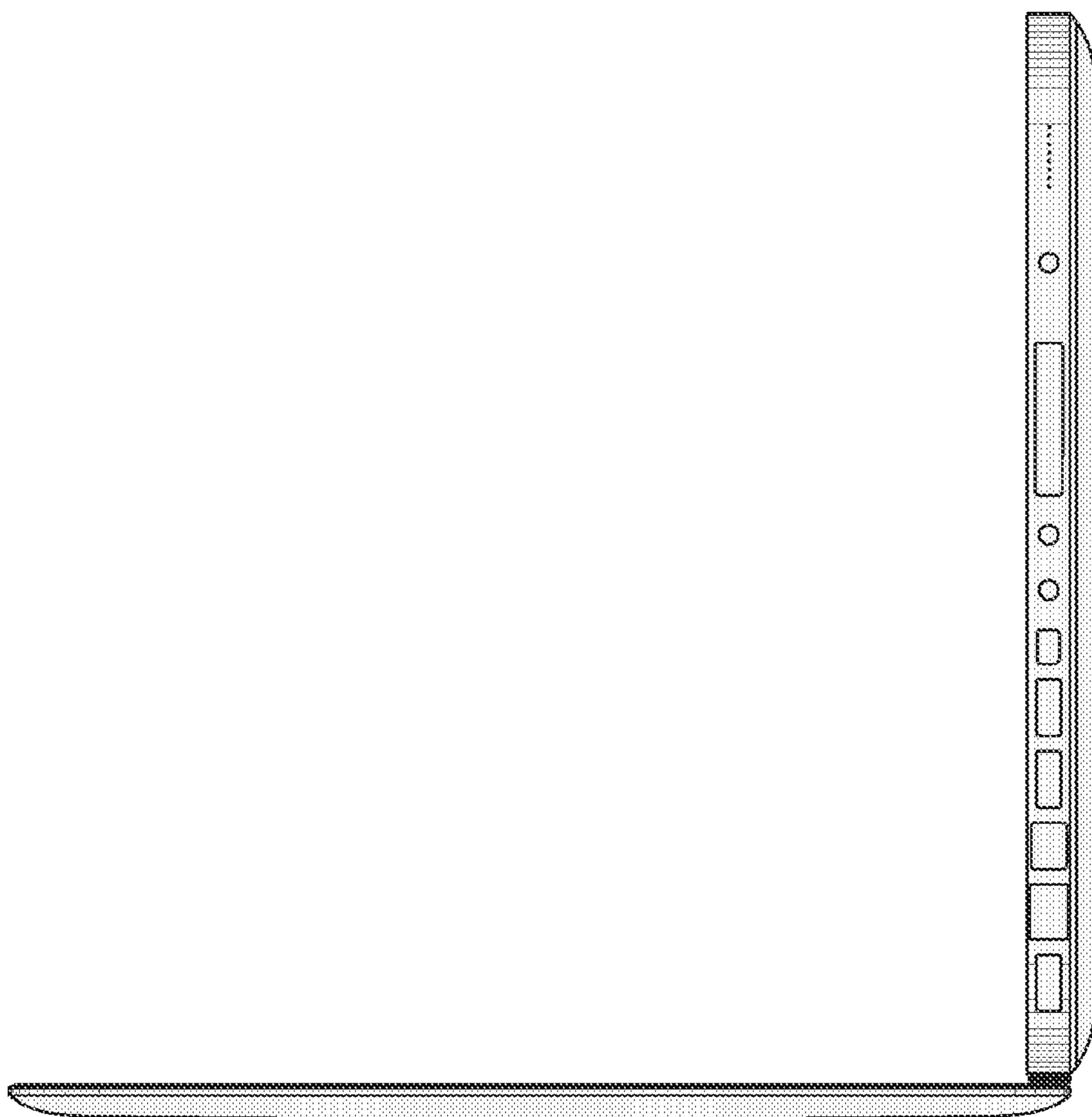

Fig. 29

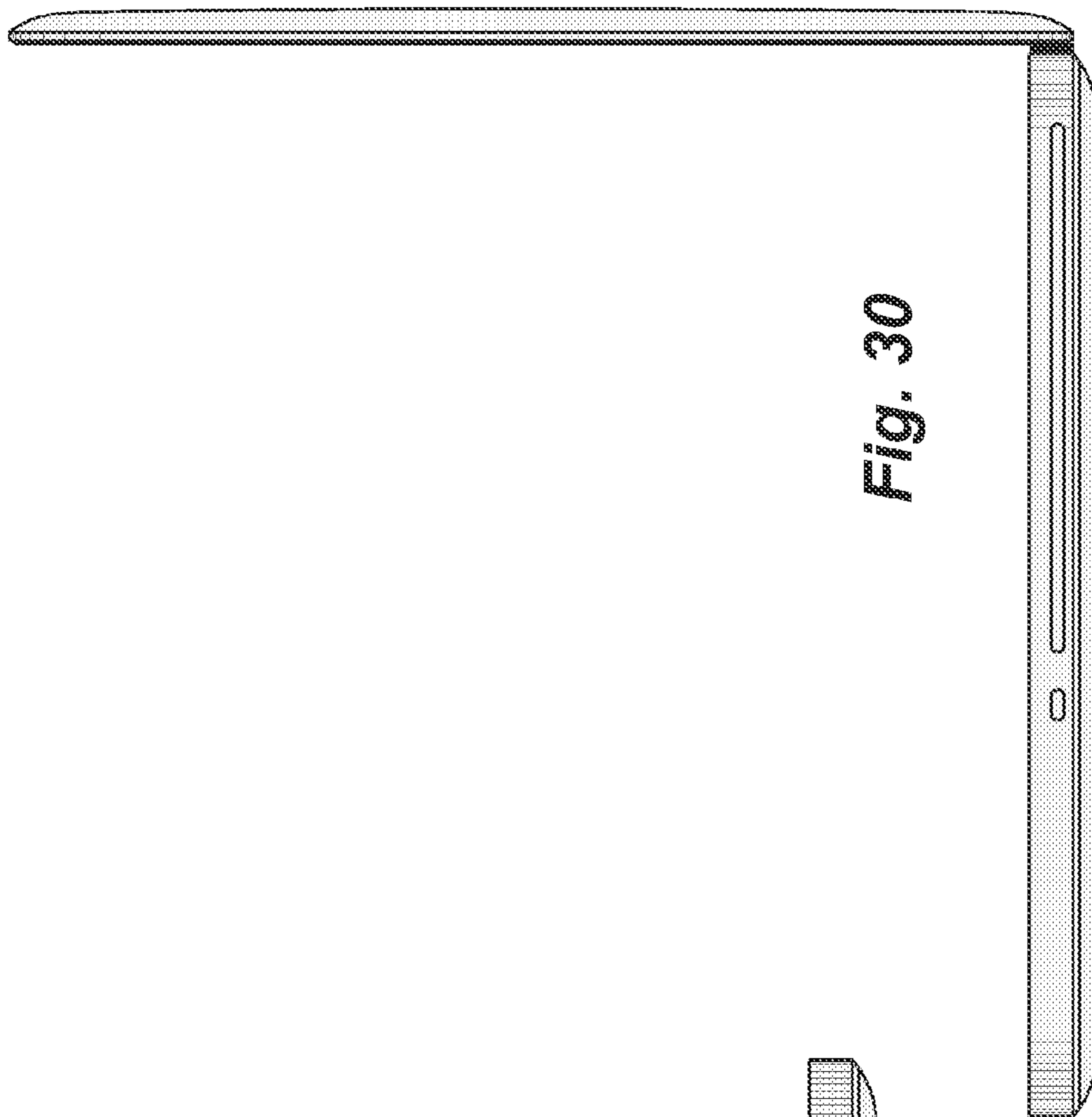

Fig. 30

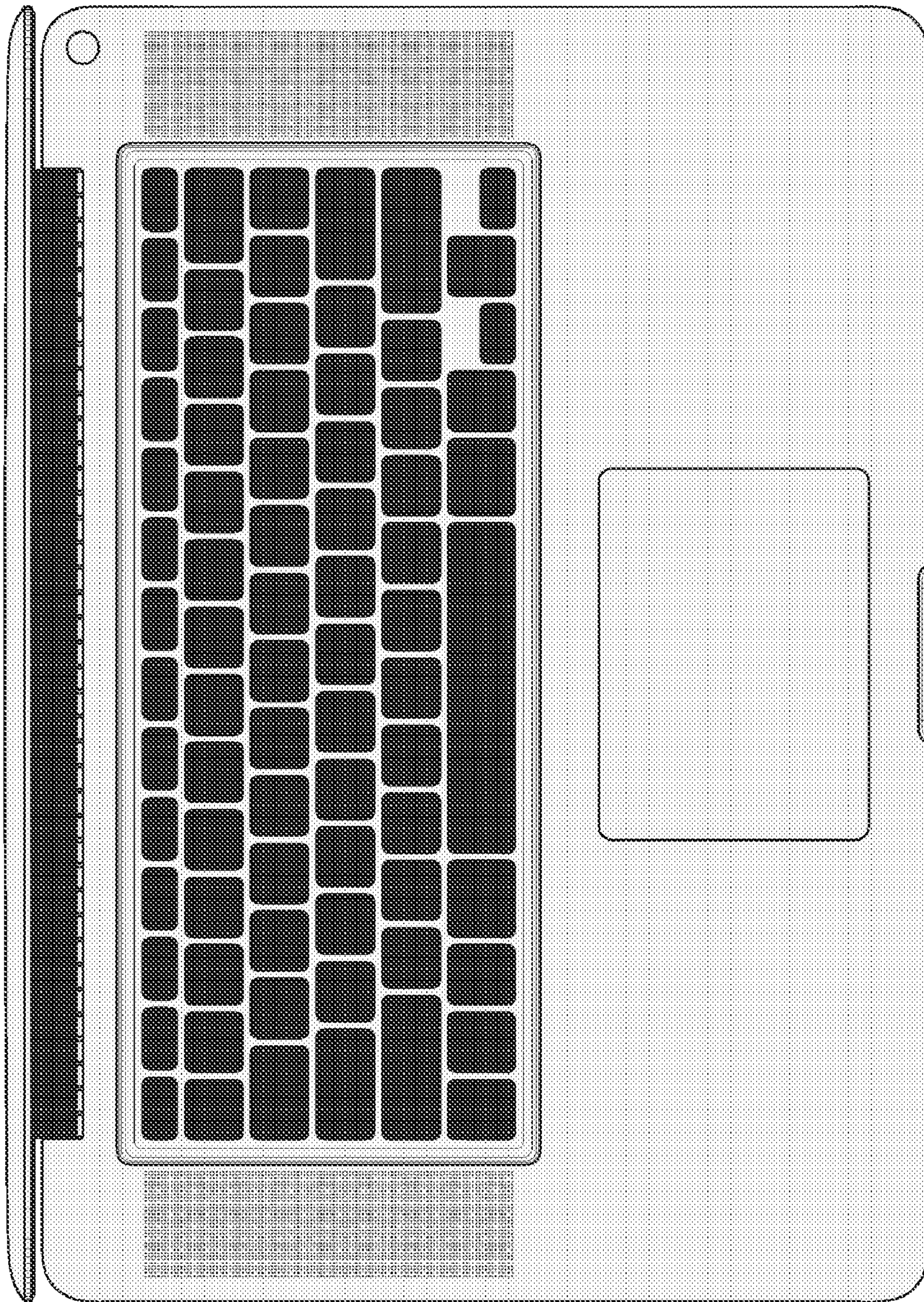

Fig. 31



Fig. 32

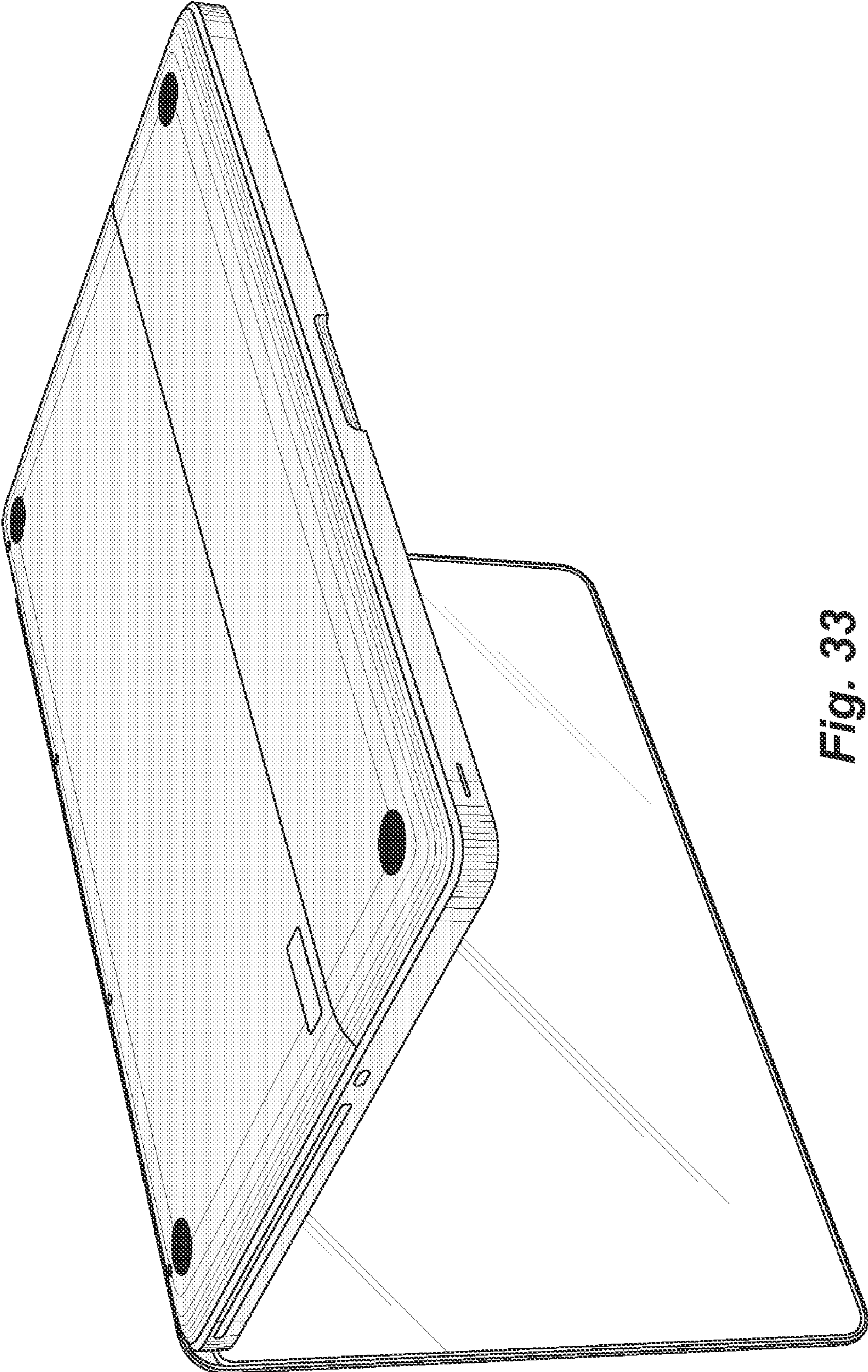

Fig. 33

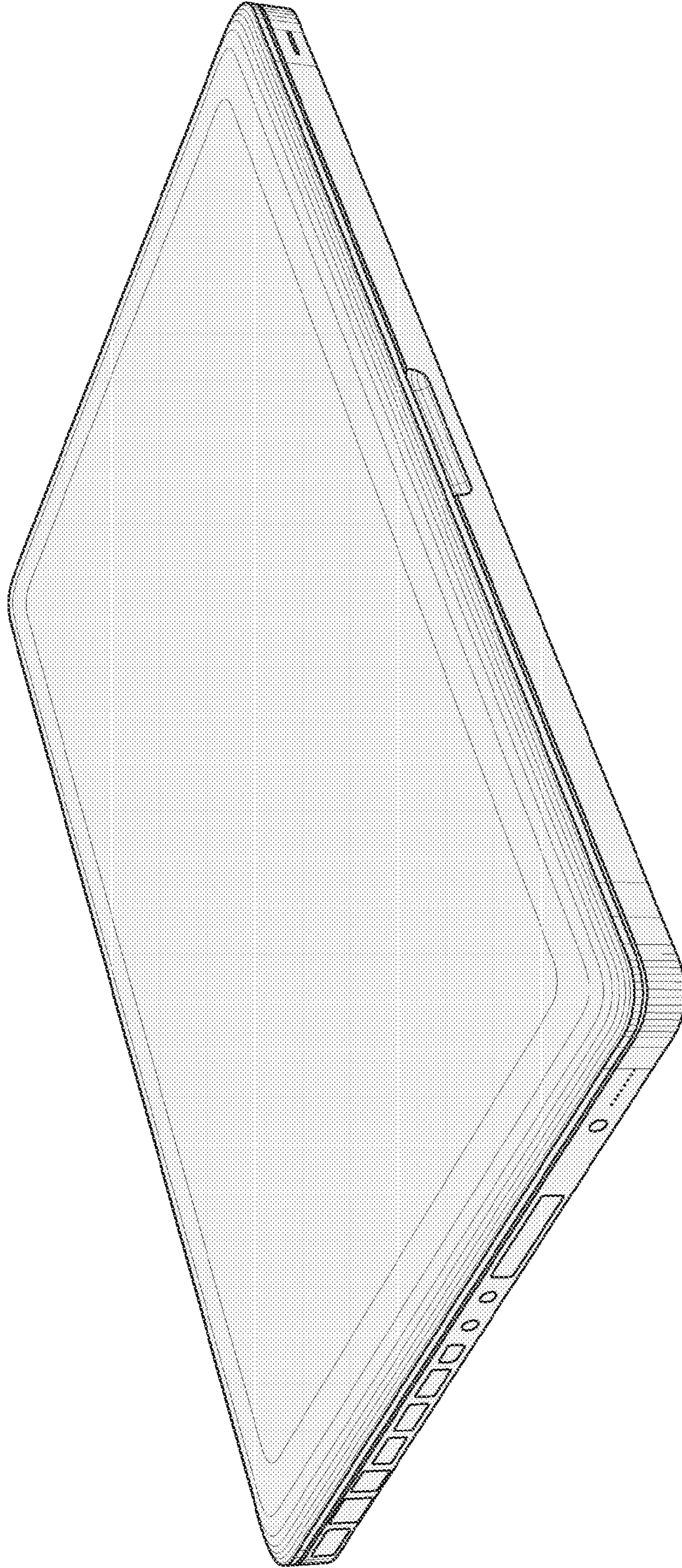
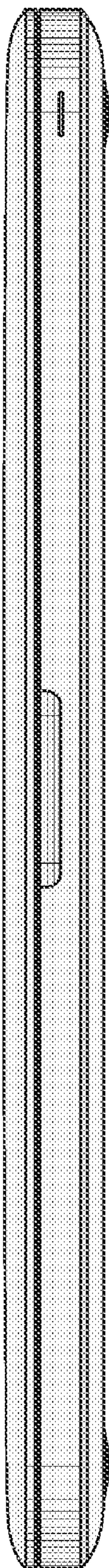
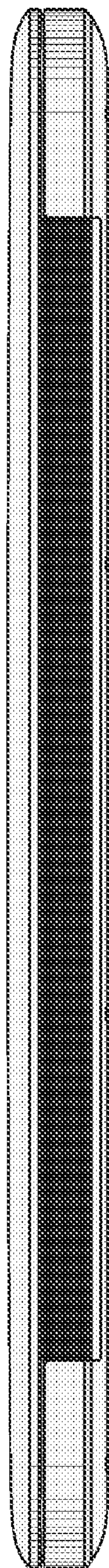

Fig. 34



*Fig. 35*



*Fig. 36*

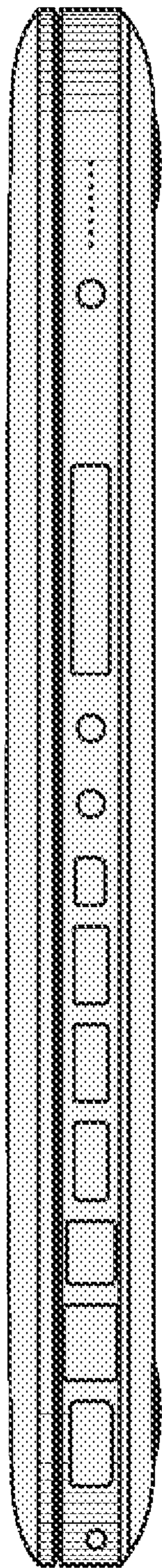

**Fig. 37**

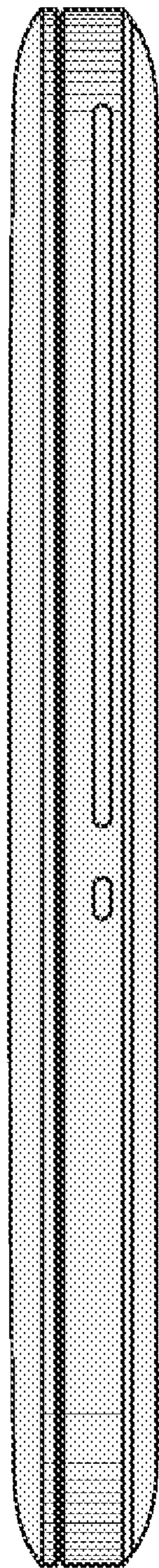

**Fig. 38**



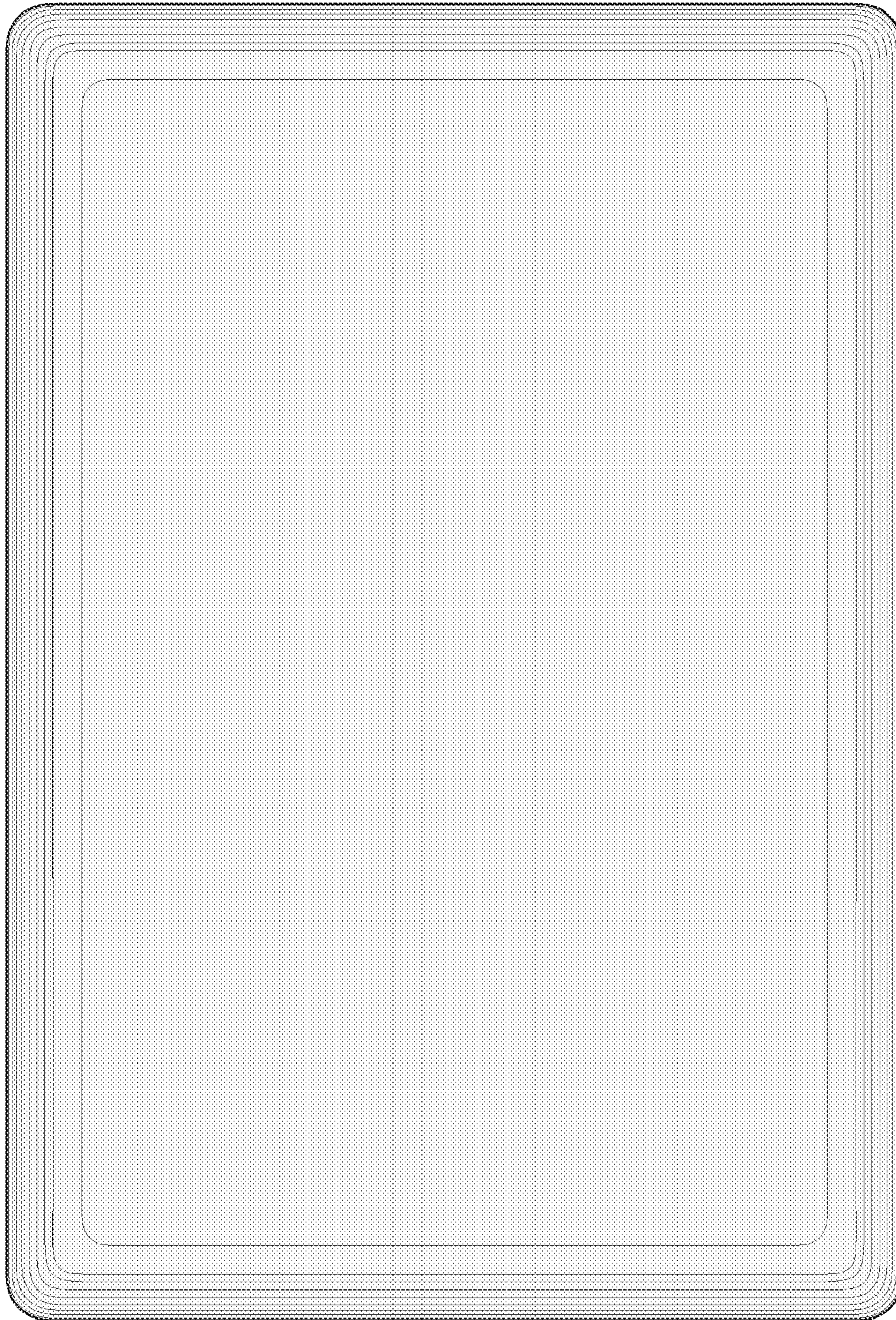
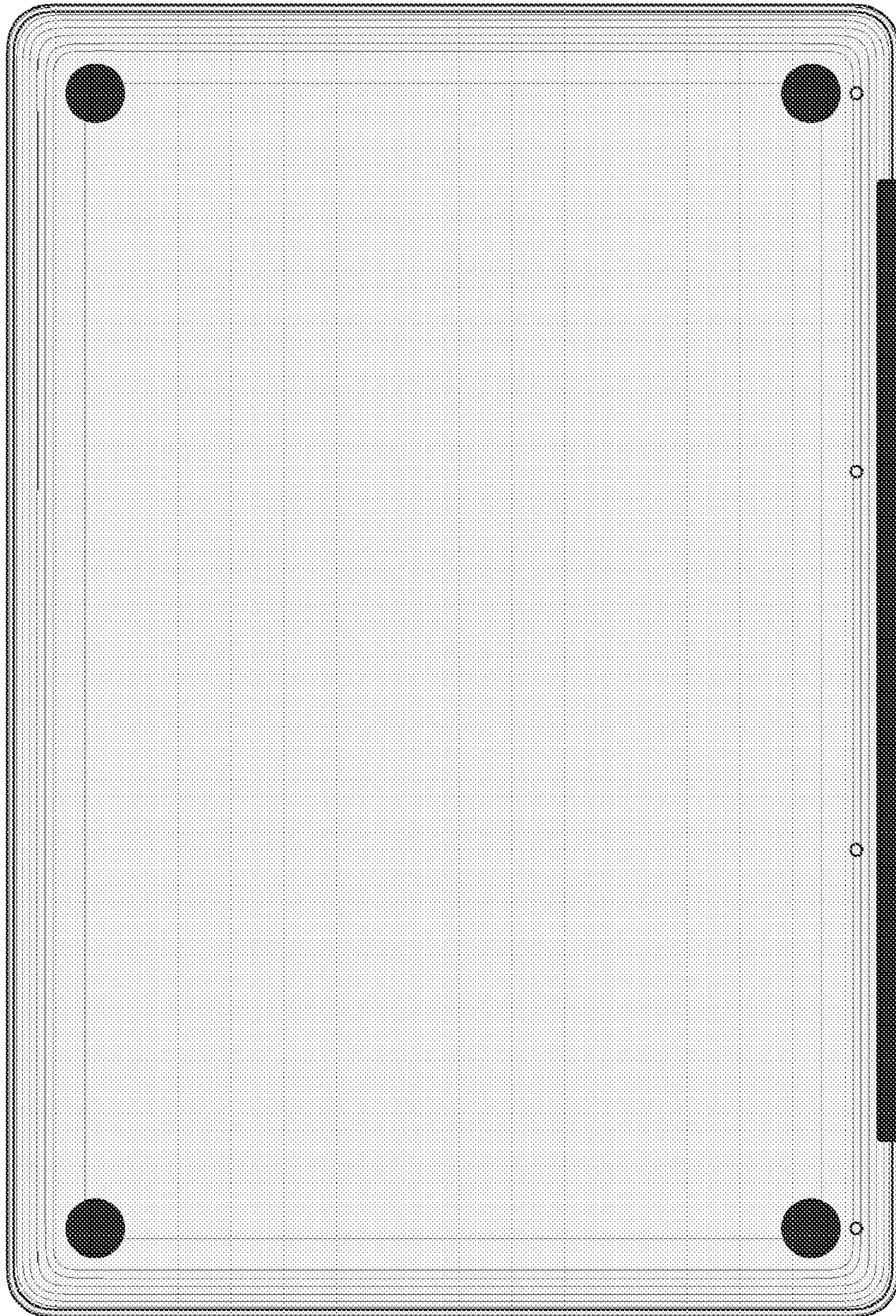

Fig. 39



*Fig. 40*

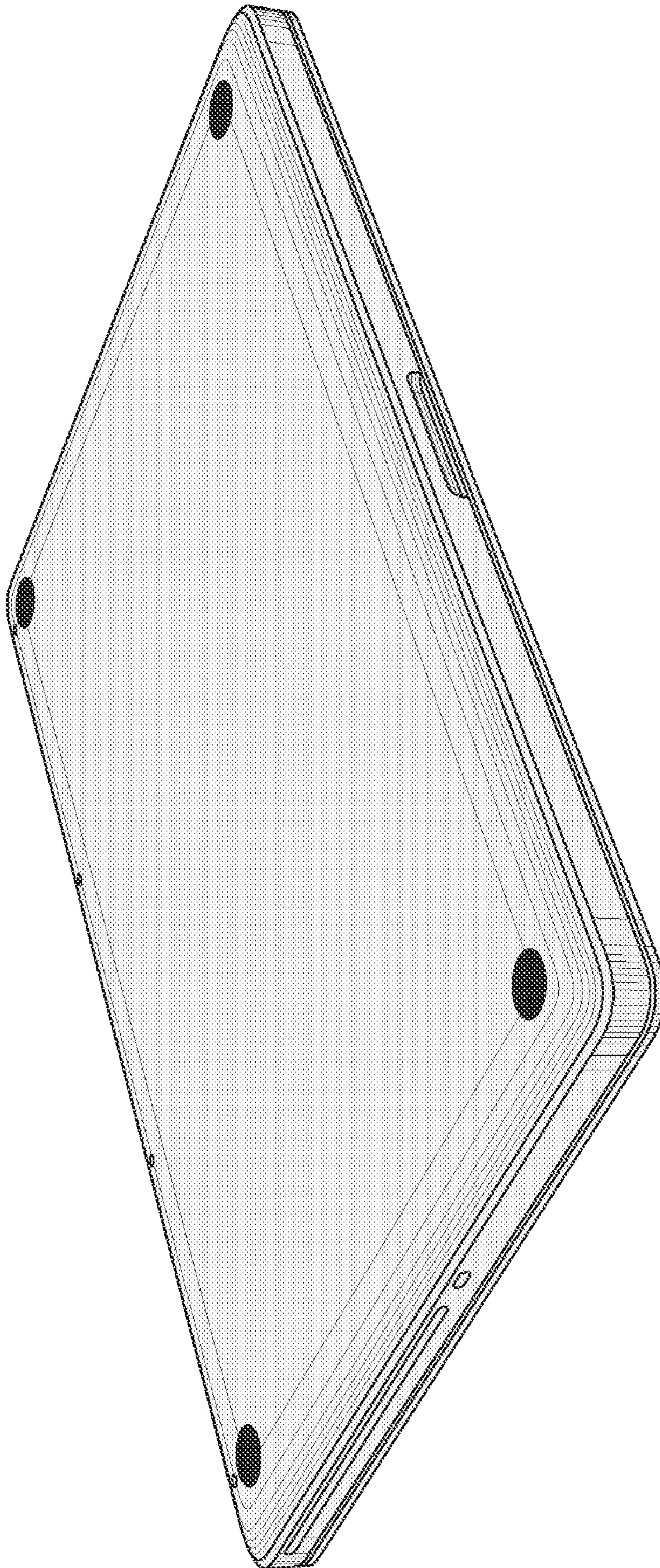

Fig. 41

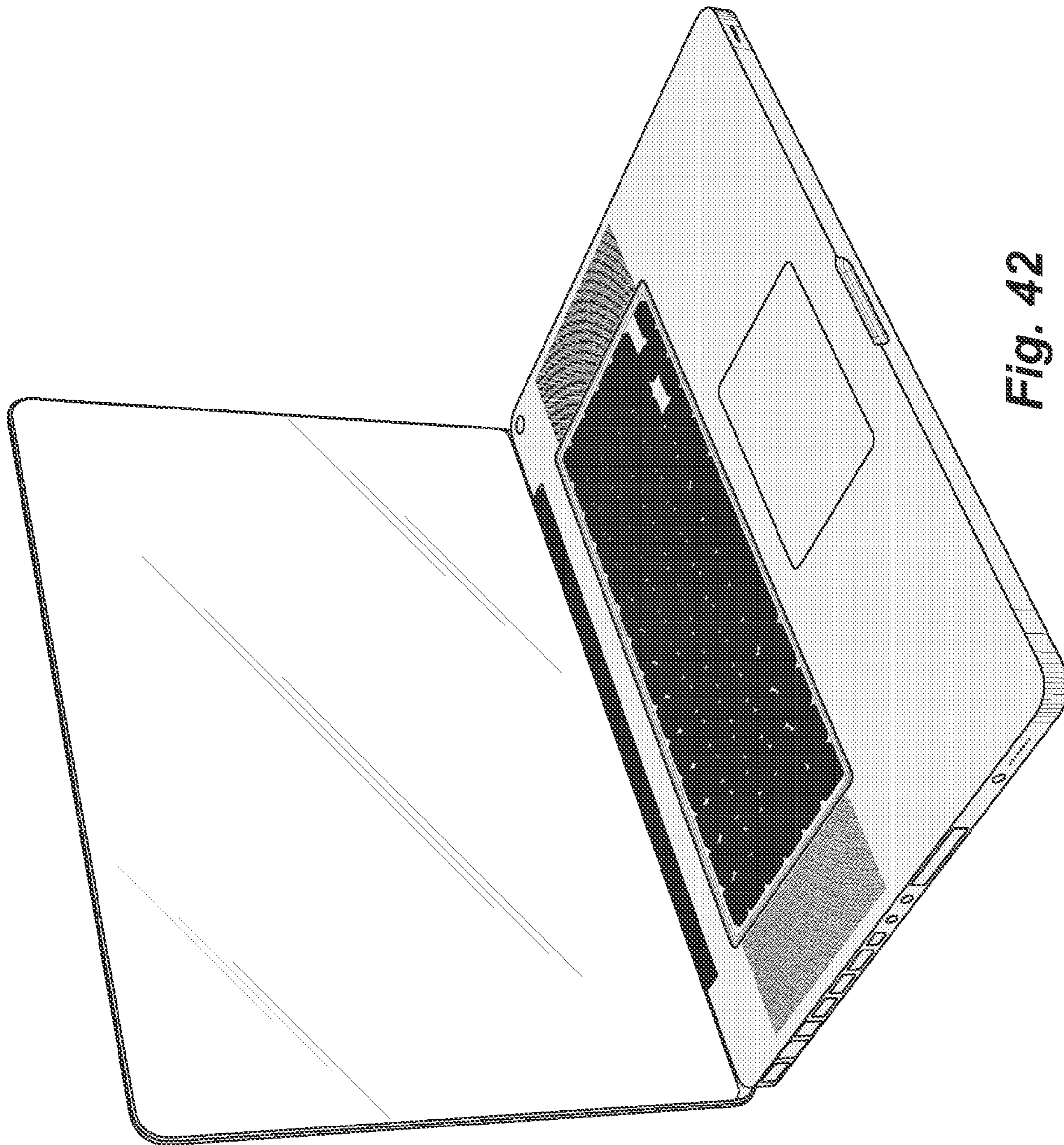

Fig. 42

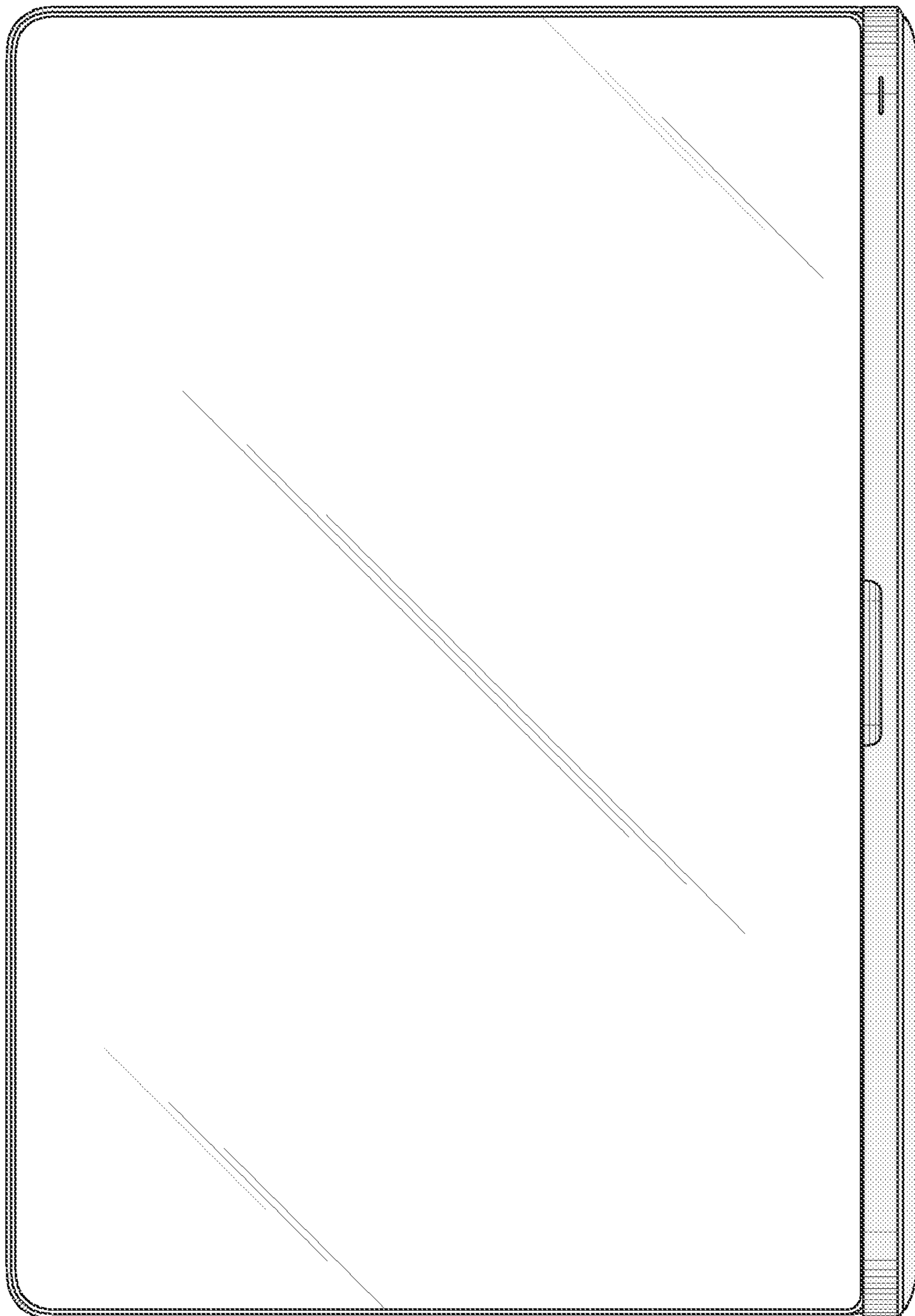
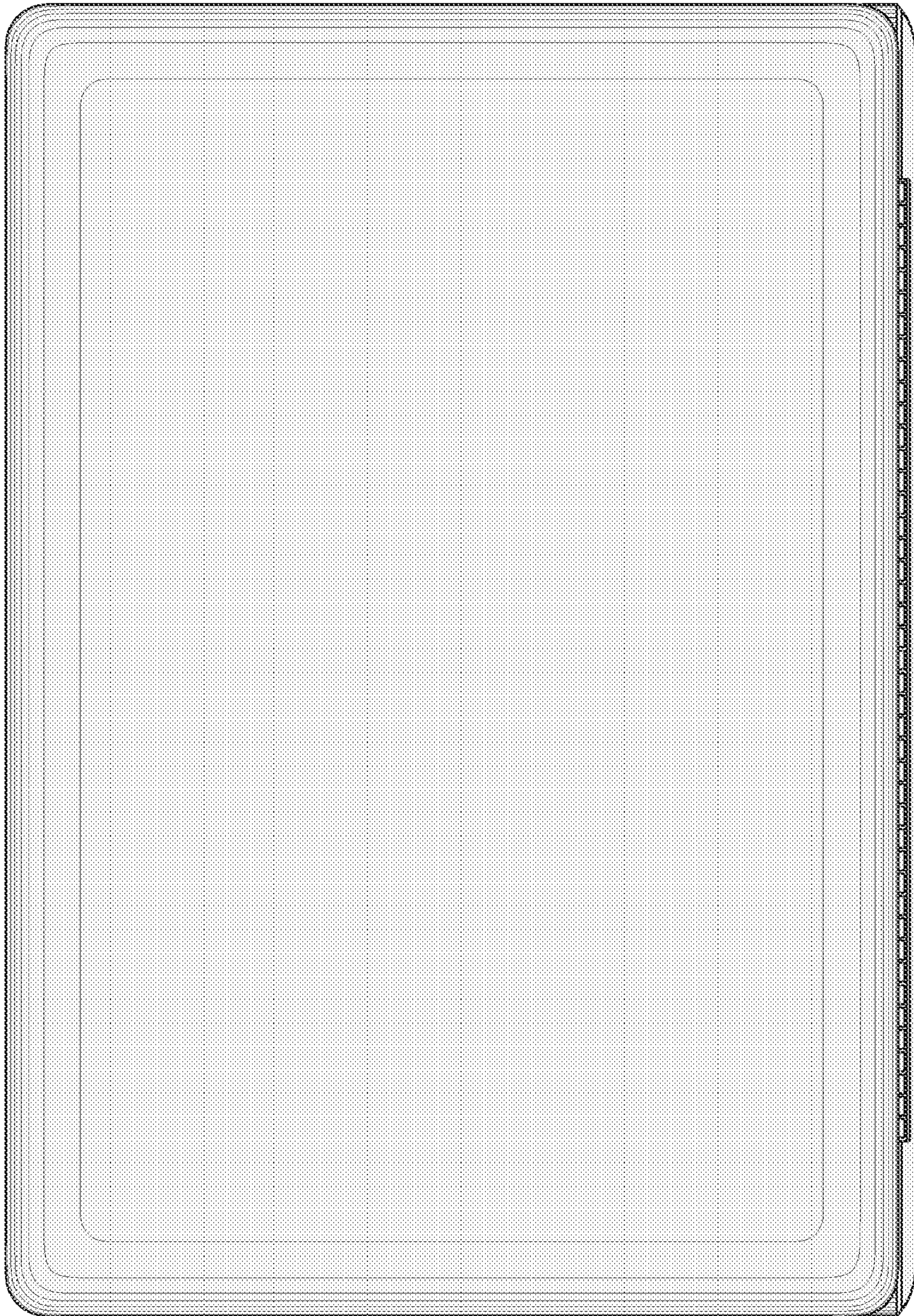

Fig. 43



*Fig. 44*

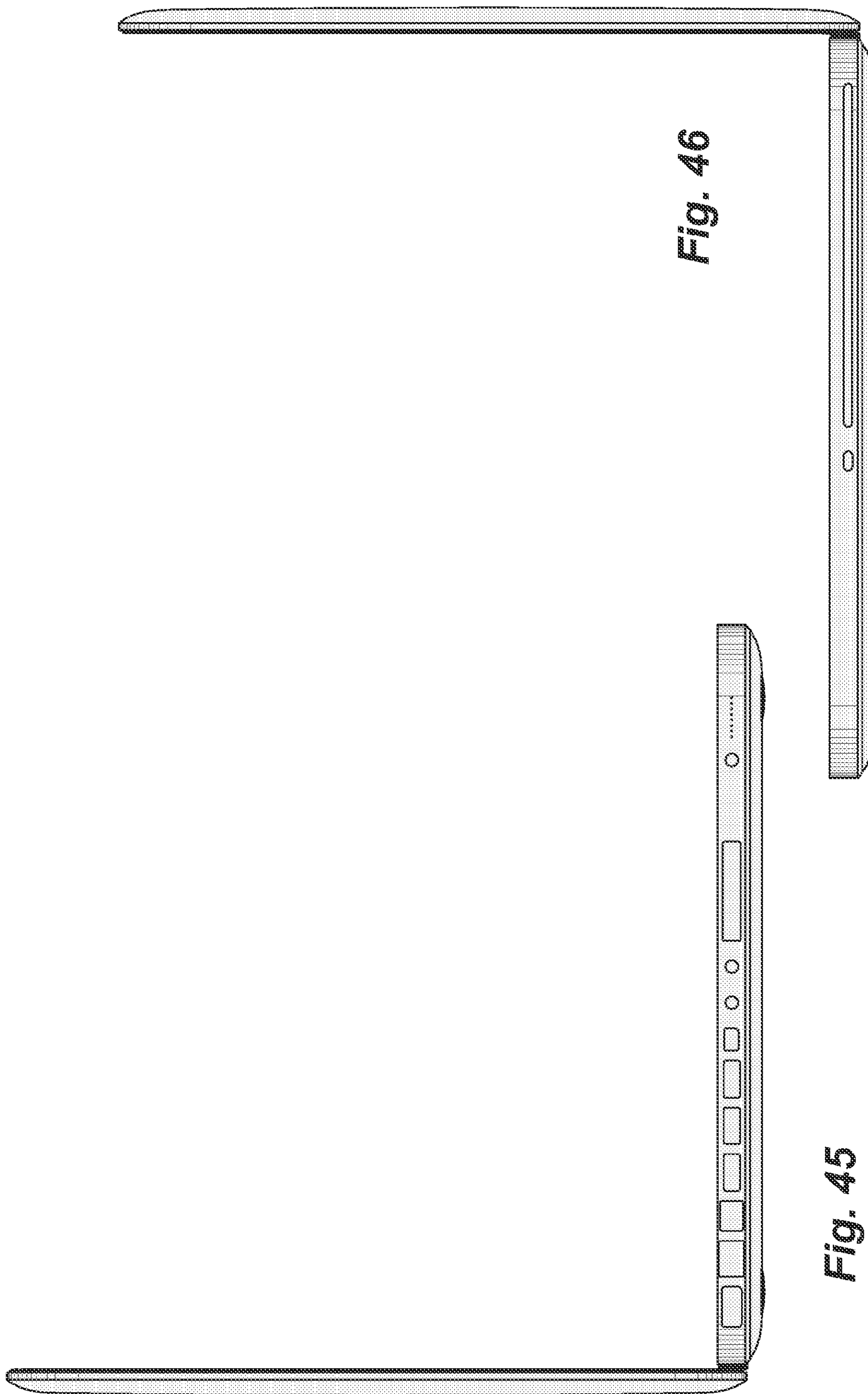
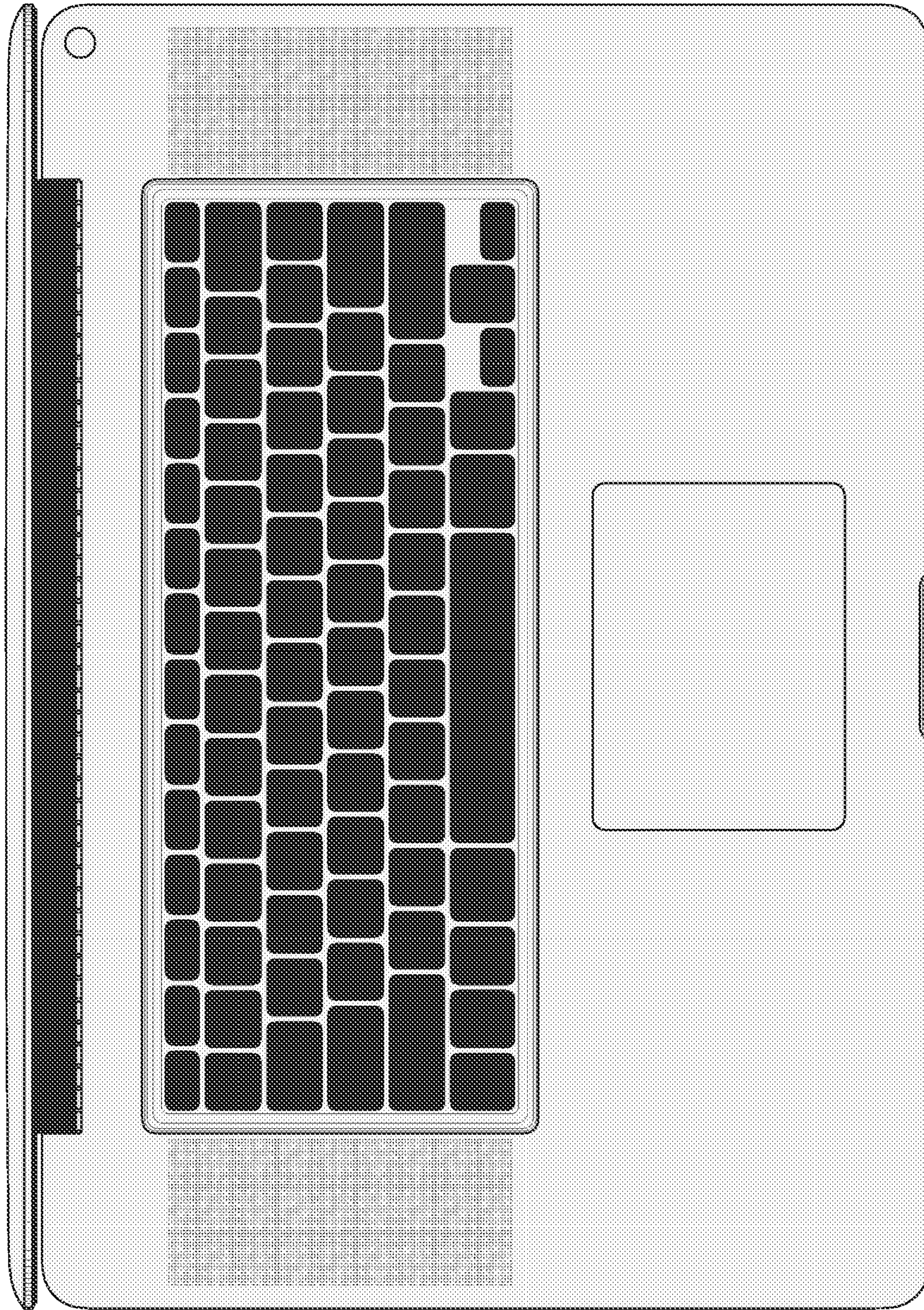

Fig. 46

Fig. 45



*Fig. 47*



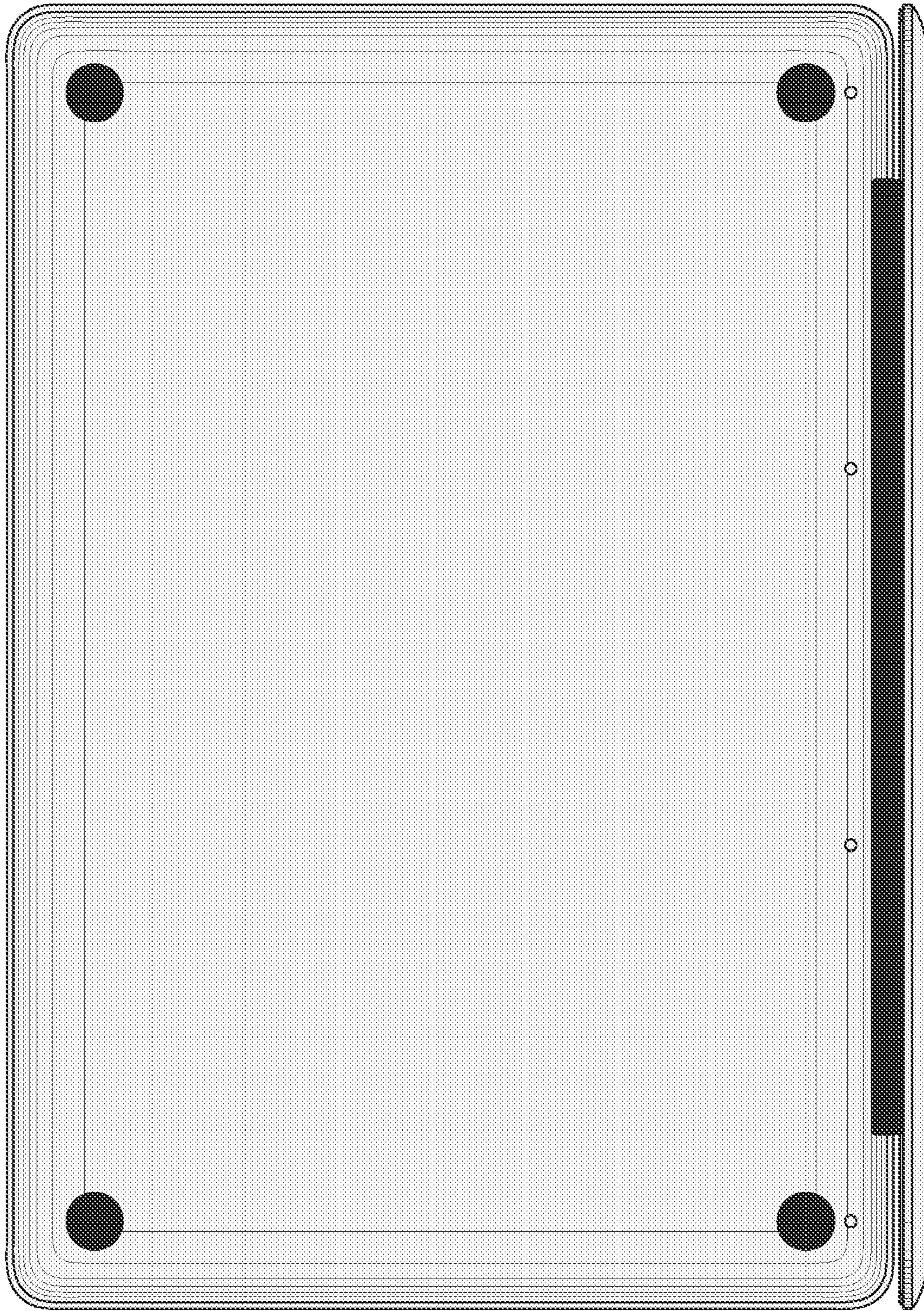

*Fig. 48*

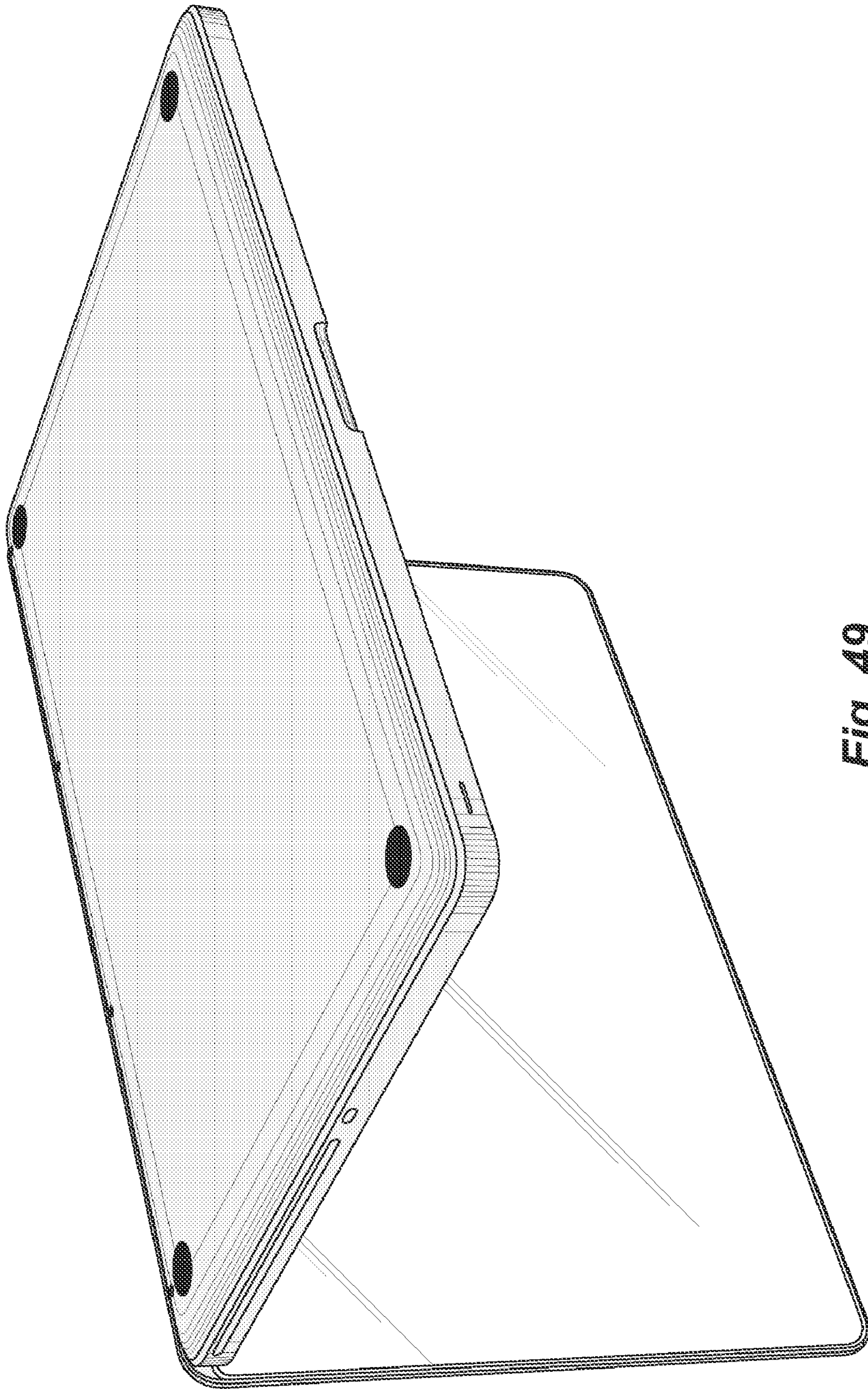

Fig. 49