



US00D611032S

(12) **United States Design Patent**
Kim

(10) **Patent No.:** **US D611,032 S**
(45) **Date of Patent:** **** Mar. 2, 2010**

(54) **RECEIVER**

(75) Inventor: **Jae Hyung Kim**, Kyungki-do (KR)

(73) Assignee: **Samsung Electronics Co., Ltd.**, Suwon (KR)

(**) Term: **14 Years**

(21) Appl. No.: **29/332,467**

(22) Filed: **Feb. 17, 2009**

(51) **LOC (9) Cl.** **14-03**

(52) **U.S. Cl.** **D14/188; D14/126**

(58) **Field of Classification Search** D14/126,
D14/133, 142, 149, 155, 157, 188, 193–198,
D14/203.1–203.8, 217, 251, 253, 432–435.1,
D14/447, 451, 474, 480.1–480.7, 496, 498,
D14/500, 502; 381/1, 2, 86, 120; 455/556.1–556.2,
455/557, 344–351

See application file for complete search history.

(56) **References Cited**

U.S. PATENT DOCUMENTS

D244,215 S * 5/1977 Ross D14/217

D372,474 S * 8/1996 Ford et al. D14/149
D413,593 S * 9/1999 Suzuki et al. D13/184
D581,393 S * 11/2008 Rodrigues D14/188
D597,103 S * 7/2009 Xiao et al. D14/500

* cited by examiner

Primary Examiner—Stella M Reid

Assistant Examiner—Keli L Hill

(74) *Attorney, Agent, or Firm*—Ladas and Parry LLP

(57) **CLAIM**

The ornamental design for a receiver, as shown and described.

DESCRIPTION

FIG. 1 is a top, front, right side perspective view of a receiver, showing my new design;

FIG. 2 is a front-side elevational view thereof;

FIG. 3 is a rear-side elevational view thereof;

FIG. 4 is a left-side elevational view thereof;

FIG. 5 is a right-side elevational view thereof;

FIG. 6 is a top-side elevational view thereof; and,

FIG. 7 is a bottom-side elevational view thereof.

1 Claim, 4 Drawing Sheets

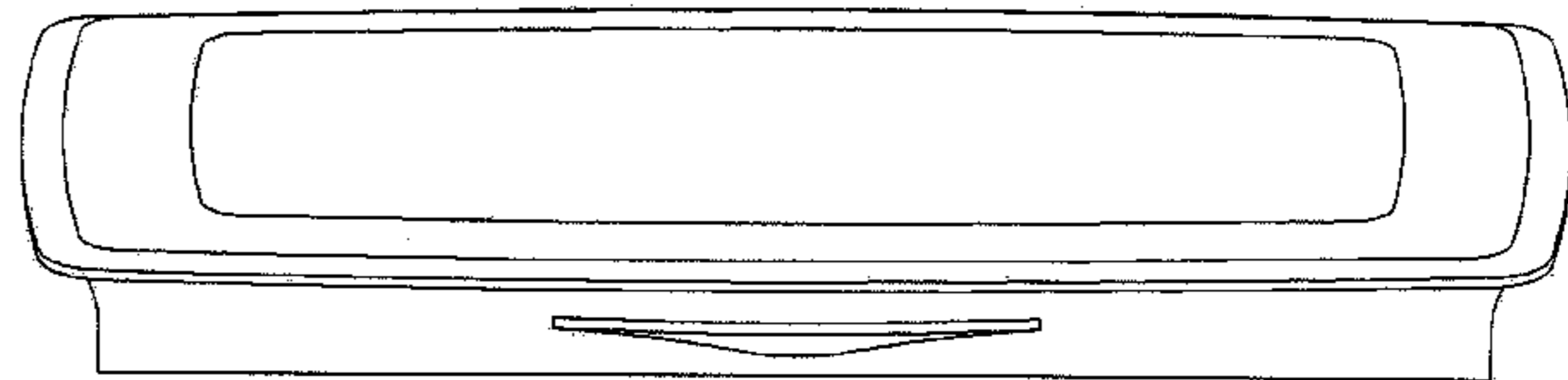
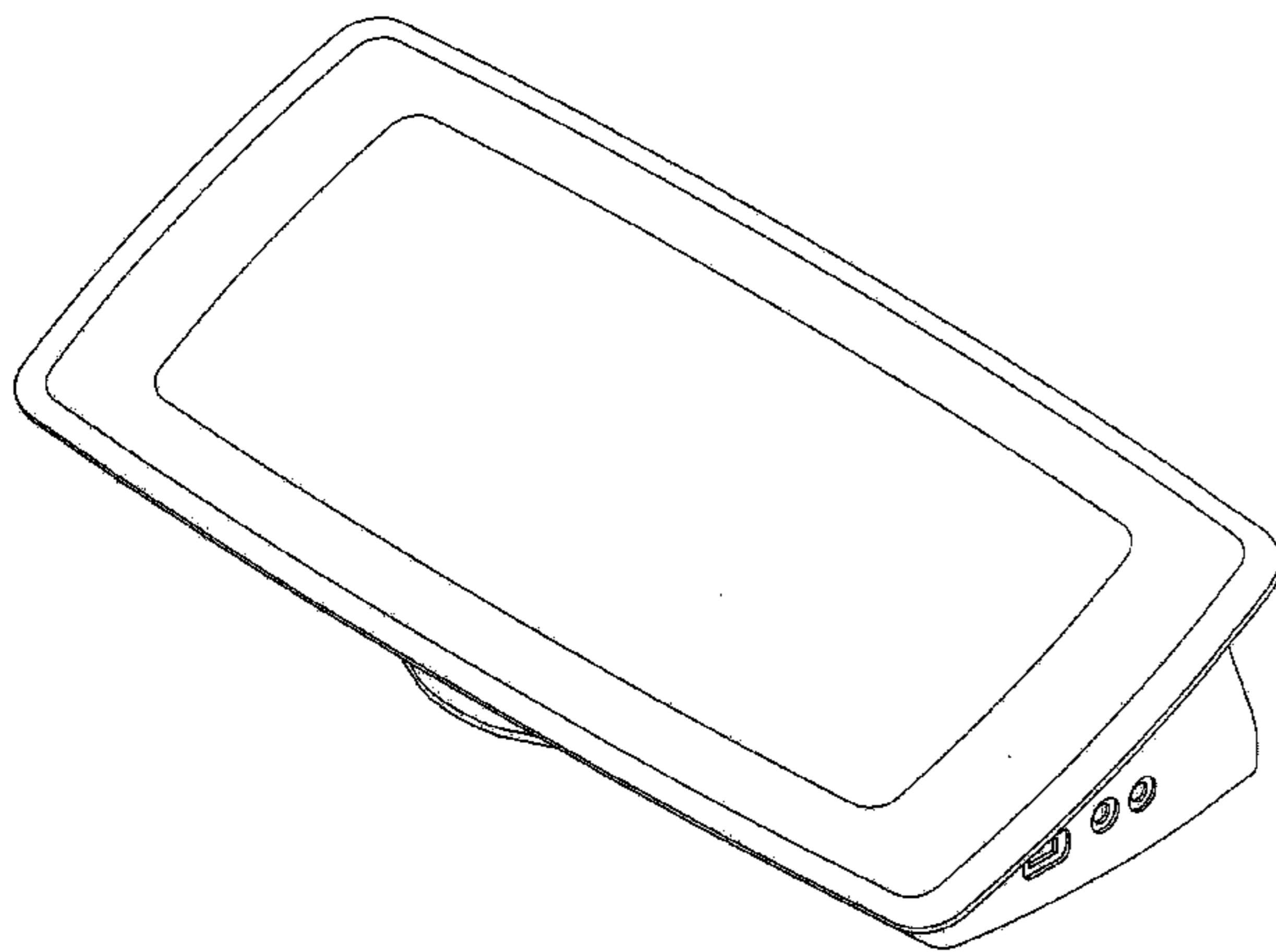

FIG. 1

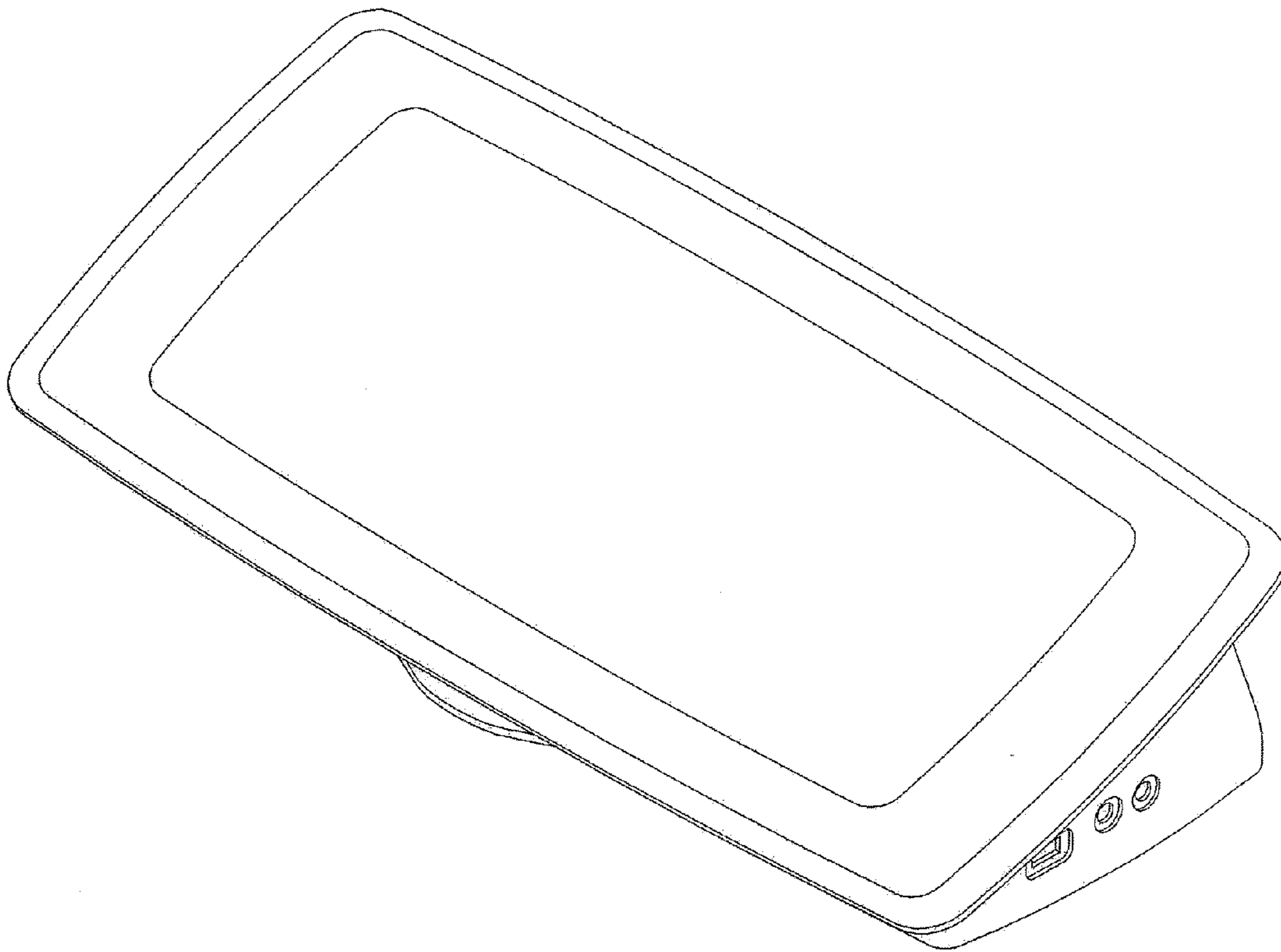

FIG. 2

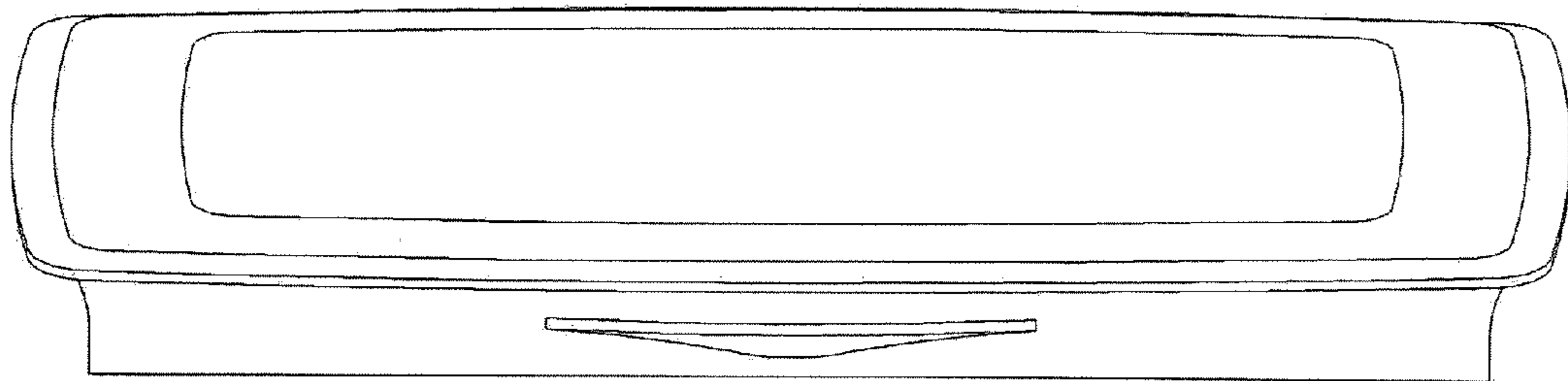

FIG. 3

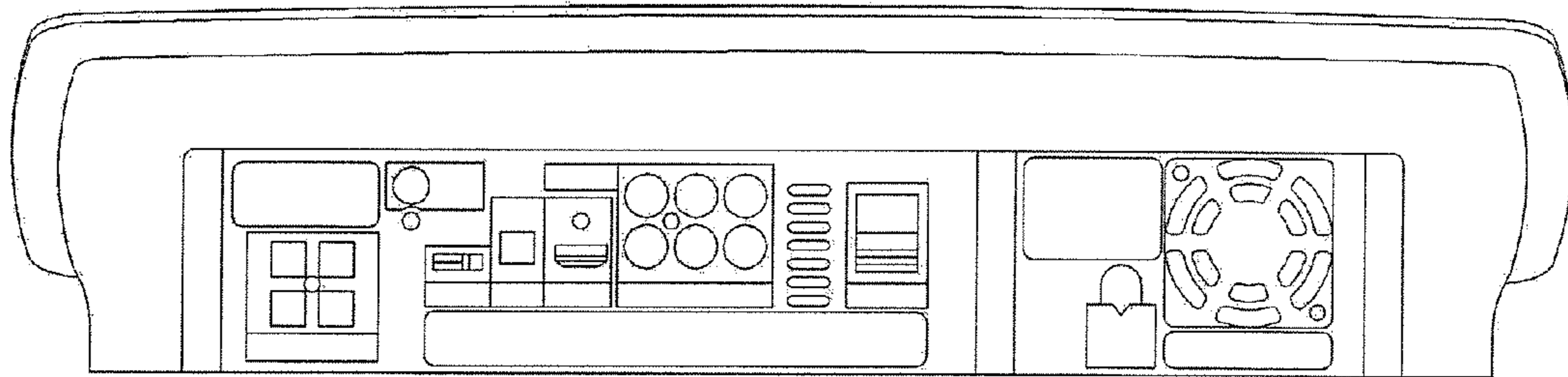

FIG. 4

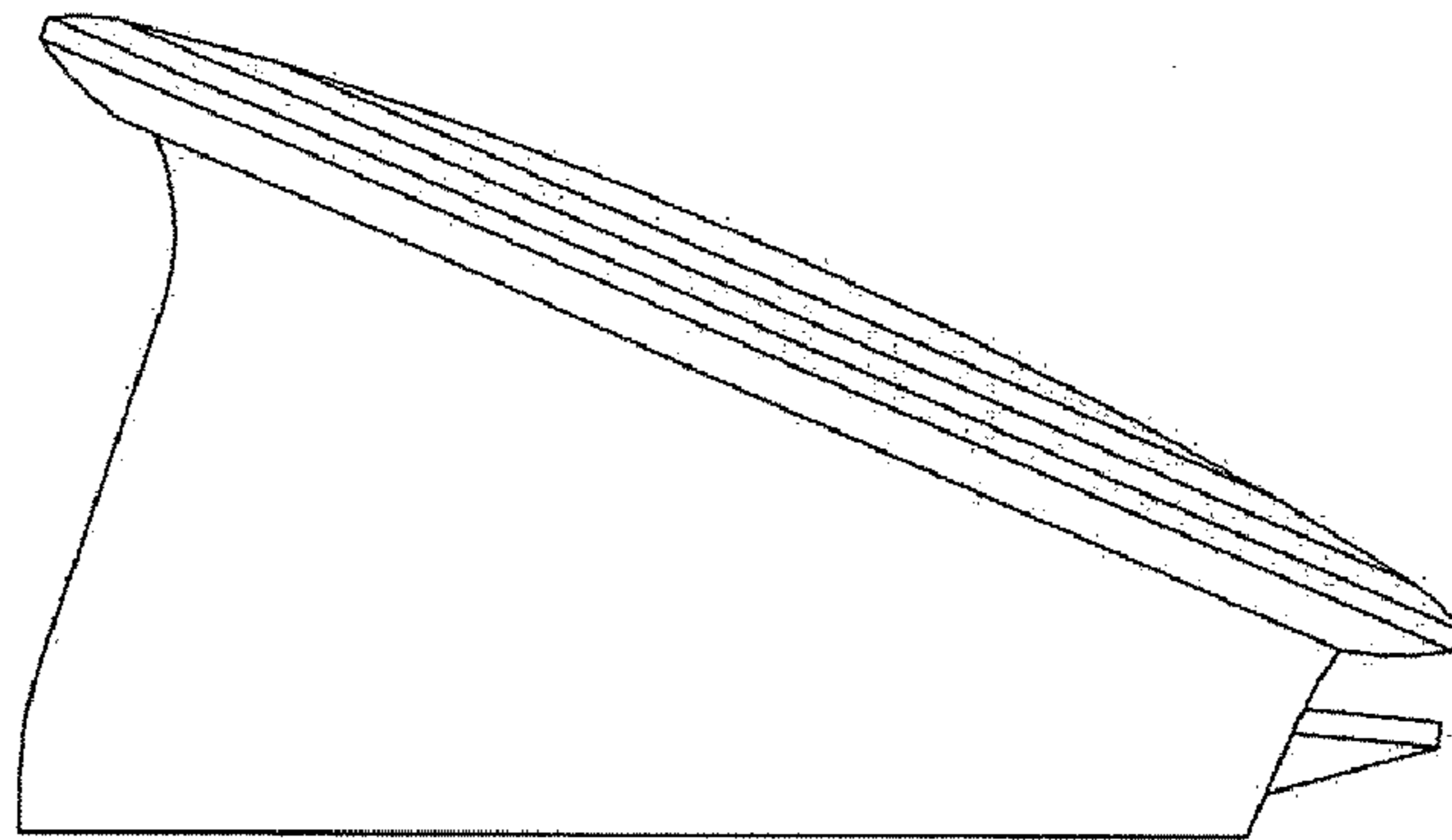

FIG. 5

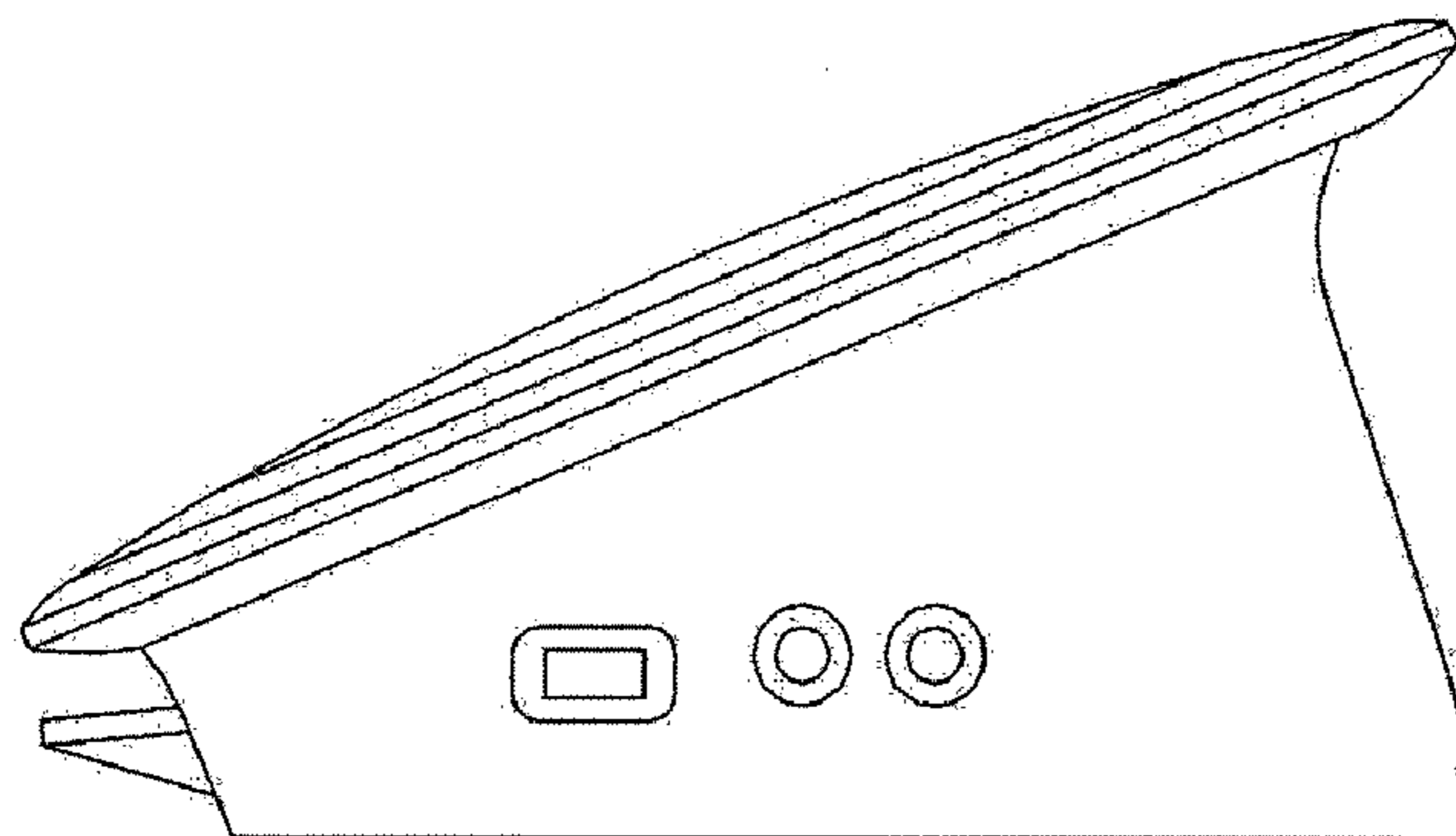

FIG. 6

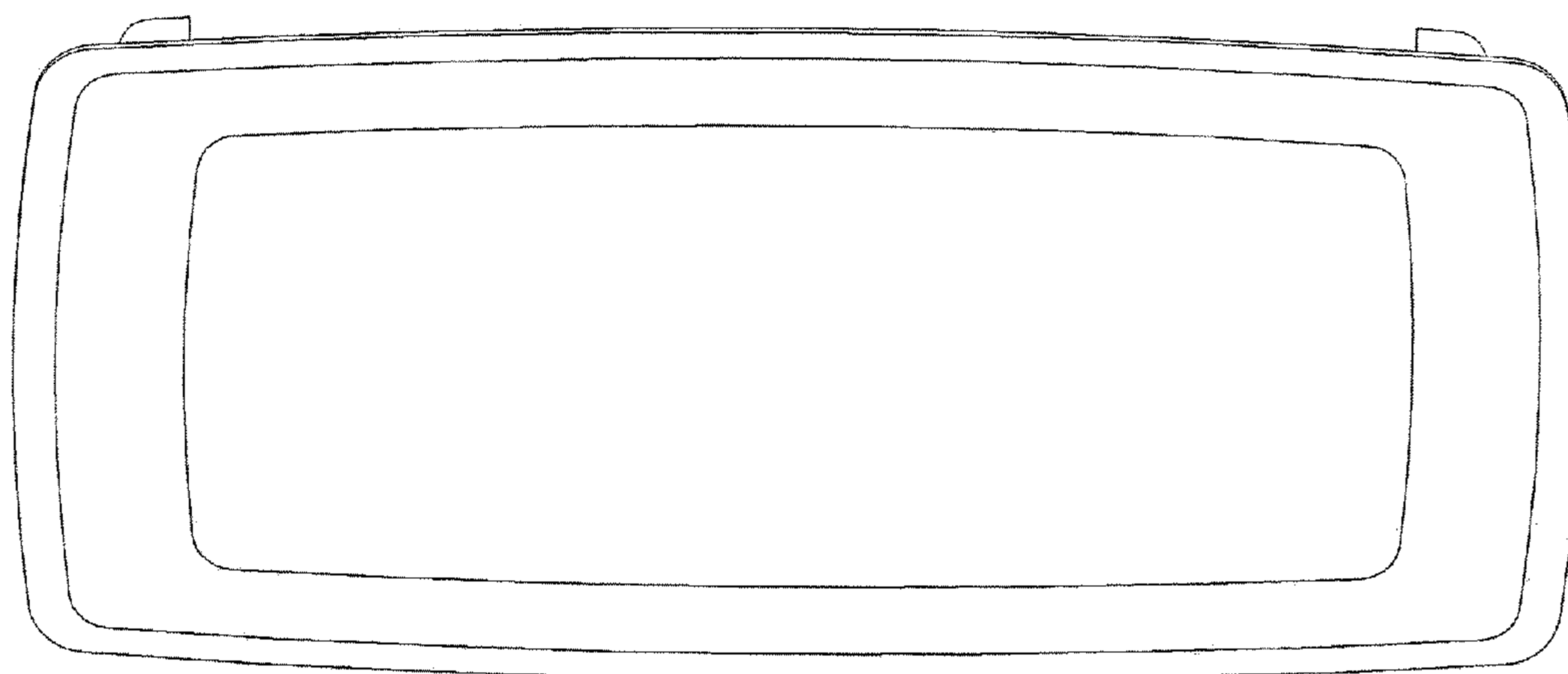

FIG. 7

