



US00D610839S

(12) **United States Design Patent**
Kinoshita et al.

(10) **Patent No.:** **US D610,839 S**
(45) **Date of Patent:** **** Mar. 2, 2010**

(54) **DESK**

(75) Inventors: **Yojiro Kinoshita**, Osaka (JP);
Yoshimasa Kato, Osaka (JP); **Hiromi Iwamuro**, Osaka (JP); **Hisashi Ejima**, Osaka (JP); **Takuya Kitamura**, Osaka (JP)

(73) Assignee: **Kokuyo Co., Ltd.**, Osaka (JP)

(**) Term: **14 Years**

(21) Appl. No.: **29/321,341**

(22) Filed: **Jul. 15, 2008**

(30) **Foreign Application Priority Data**

Jan. 15, 2008 (JP) 2008-000601

(51) **LOC (9) Cl.** **06-03**

(52) **U.S. Cl.** **D6/484**

(58) **Field of Classification Search** D6/480-489,
D6/495-499, 439-431, 422, 423, 425, 427,
D6/428, 477-479; 108/150, 153.1, 155,
108/156, 161, 115, 118, 131, 129, 132, 120,
108/50.01, 50.02, 152; 248/188, 188.1, 188.8;
312/194, 195

See application file for complete search history.

(56) **References Cited**

U.S. PATENT DOCUMENTS

D183,361 S * 8/1958 McCarthy D6/426
3,366,431 A * 1/1968 Hanson 312/208.1
D225,046 S * 11/1972 Nance D6/423
D275,352 S * 9/1984 Foyle D6/482
D294,440 S * 3/1988 Werner D6/422
D370,571 S * 6/1996 Newhouse et al. D6/429
D379,887 S * 6/1997 Muller-Deisig et al. D6/484
D399,077 S * 10/1998 Lepper et al. D6/484
D405,991 S * 2/1999 Kramer et al. D6/484
D526,812 S * 8/2006 Chen D6/425

D539,059 S * 3/2007 Vander Park D6/484
D539,568 S * 4/2007 Vander Park D6/484

* cited by examiner

Primary Examiner—Janice E Seeger

(74) *Attorney, Agent, or Firm*—Dennis R. Haszko; Eaton Peabody Patent Group, LLC

(57) **CLAIM**

The ornamental design for a desk, is shown and described.

DESCRIPTION

FIG. 1 is a front perspective view of the desk showing the design;

FIG. 2 is a front elevation view thereof;

FIG. 3 is a sectional view taken along the section line 3—3 of FIG. 2;

FIG. 4 is a sectional view taken along the section line 4—4 of FIG. 2;

FIG. 5 is a sectional view taken along the section line 5—5 of FIG. 2;

FIG. 6 is a rear elevation view thereof;

FIG. 7 is a top plan view thereof;

FIG. 8 is a bottom plan view thereof;

FIG. 9 is a right elevation view thereof, the left elevation view being a mirror image in a standard configuration;

FIG. 10 is a sectional view taken along the section line 10—10 of FIG. 9, in which only the sectioned components are shown;

FIG. 11 is an expanded partial view of the desk;

FIG. 12 is a top plan view showing the desk in a modified arrangement, in which the side table is in an alternate position to that shown in FIGS. 1 to 11; and,

FIG. 13 is a top plan view showing the desk in a modified arrangement, in which the side table is in an alternate position to that shown in FIGS. 1 to 11.

The broken lines are for environmental purposes only and form no part of the claimed design.

1 Claim, 10 Drawing Sheets

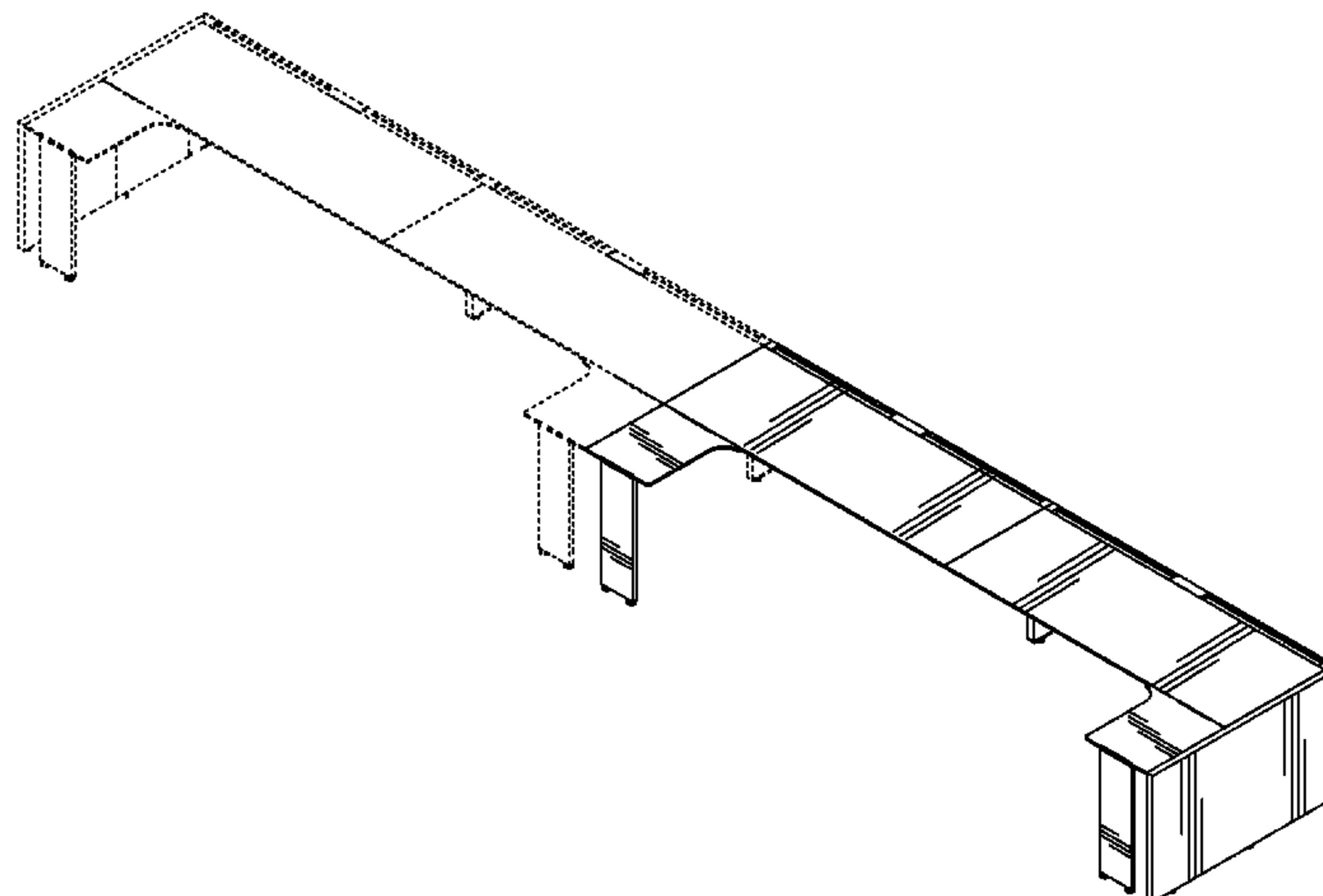

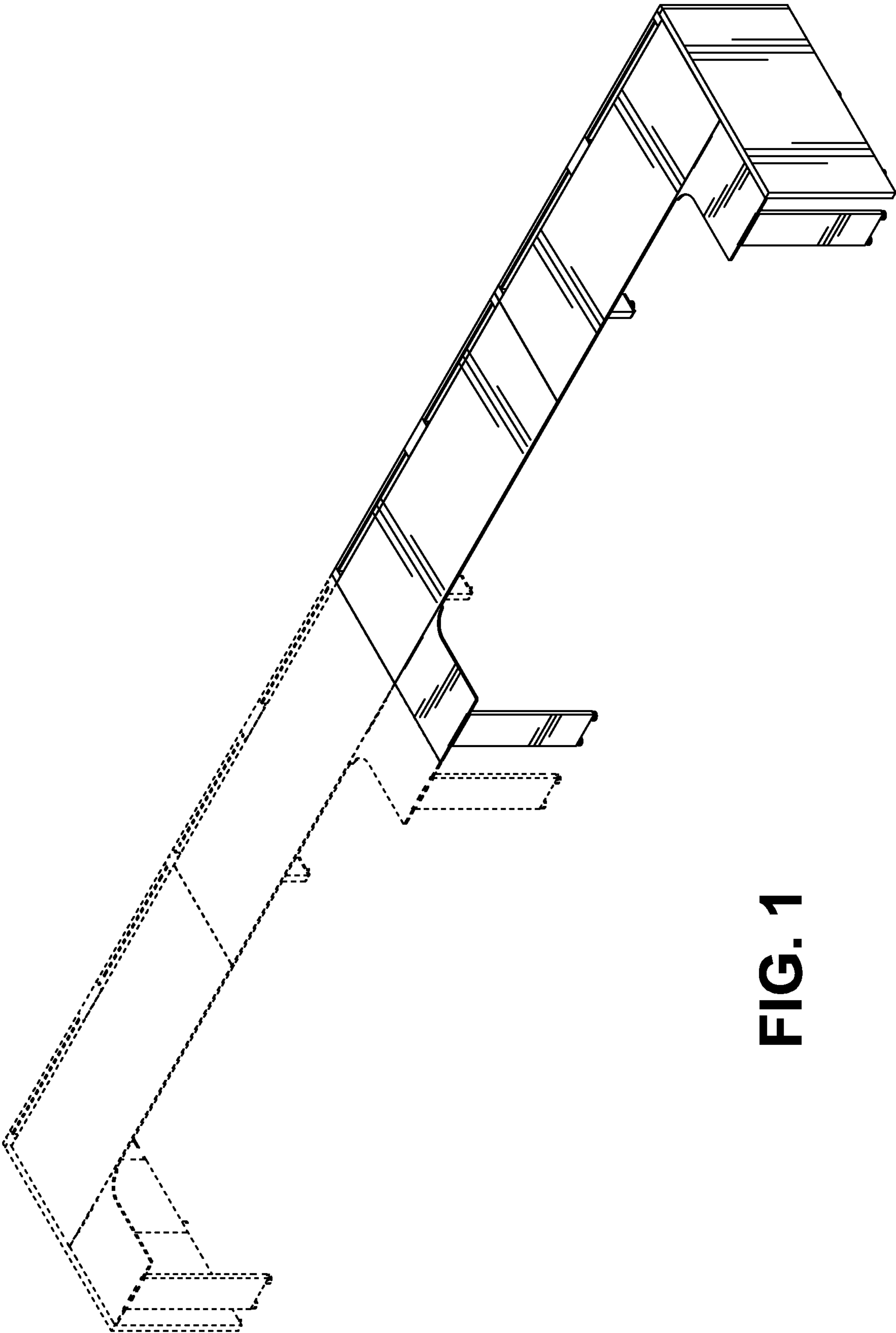

FIG. 1

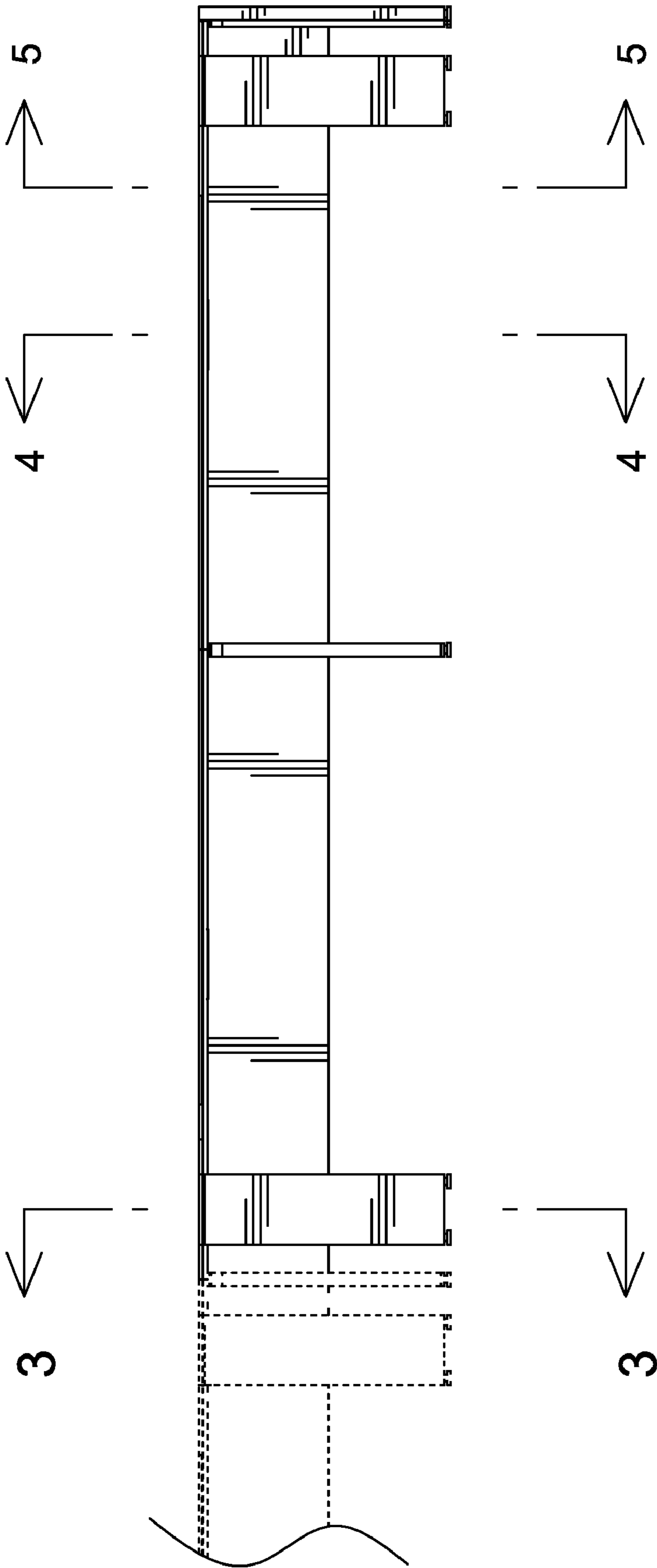

FIG. 2

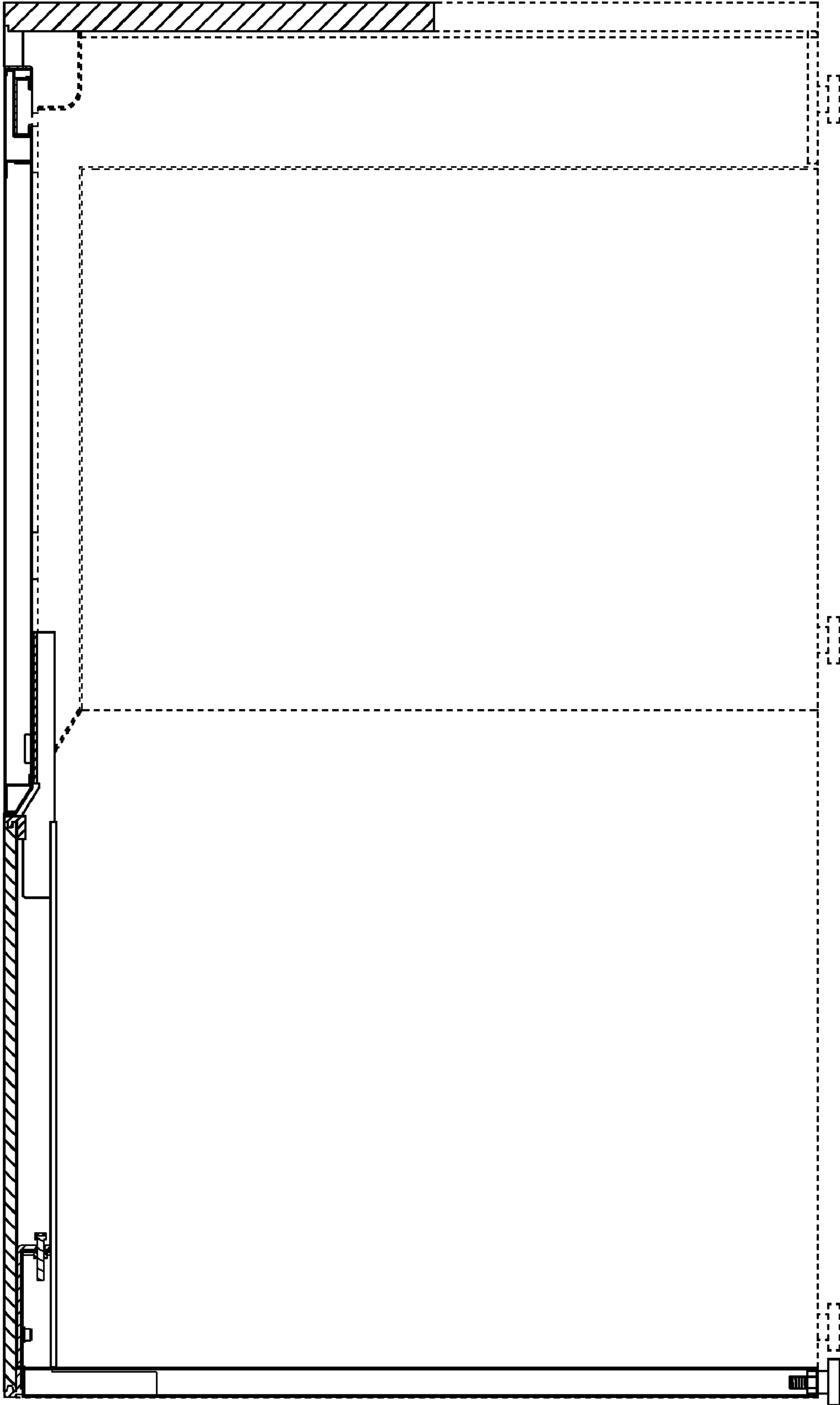

FIG. 3

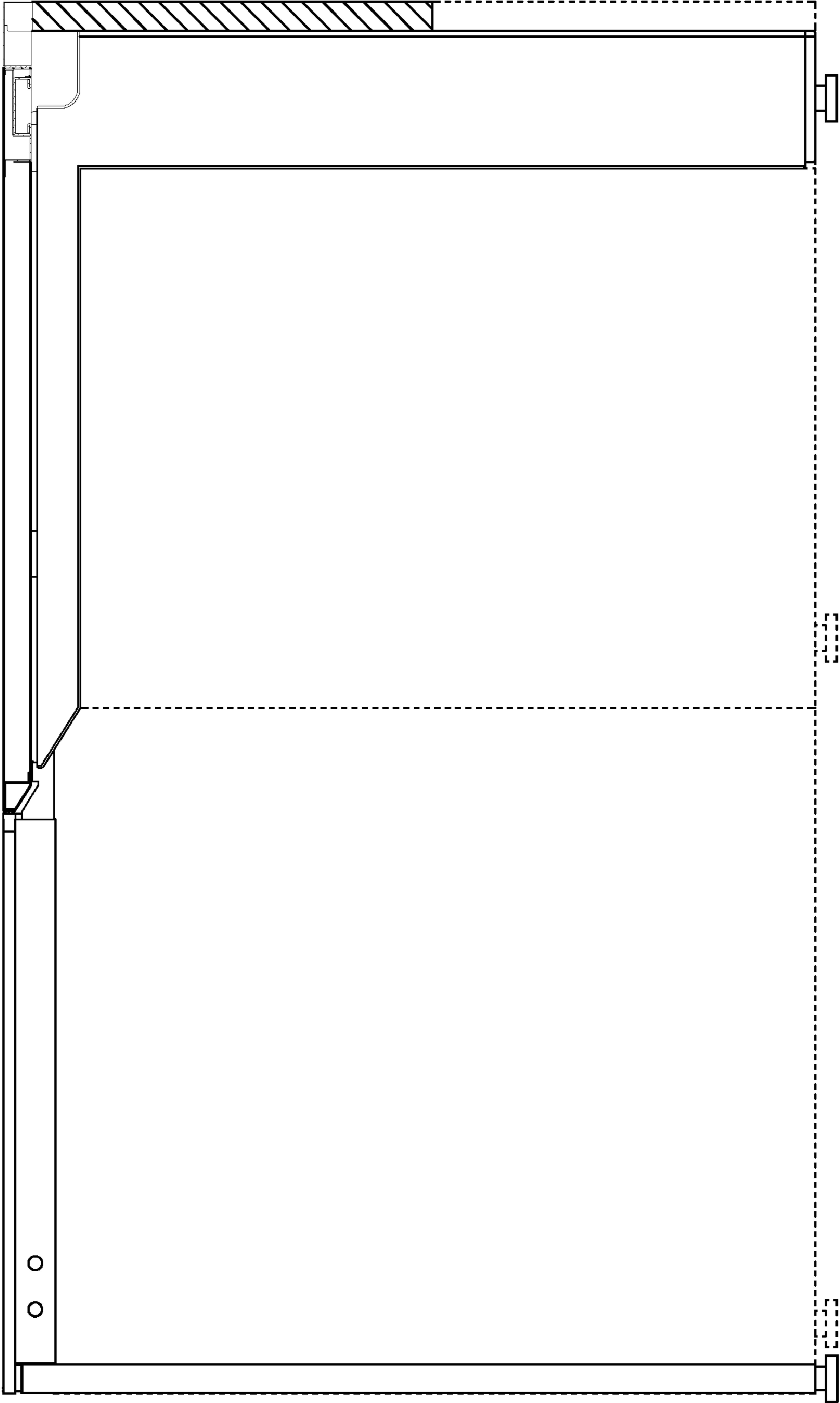

FIG. 4

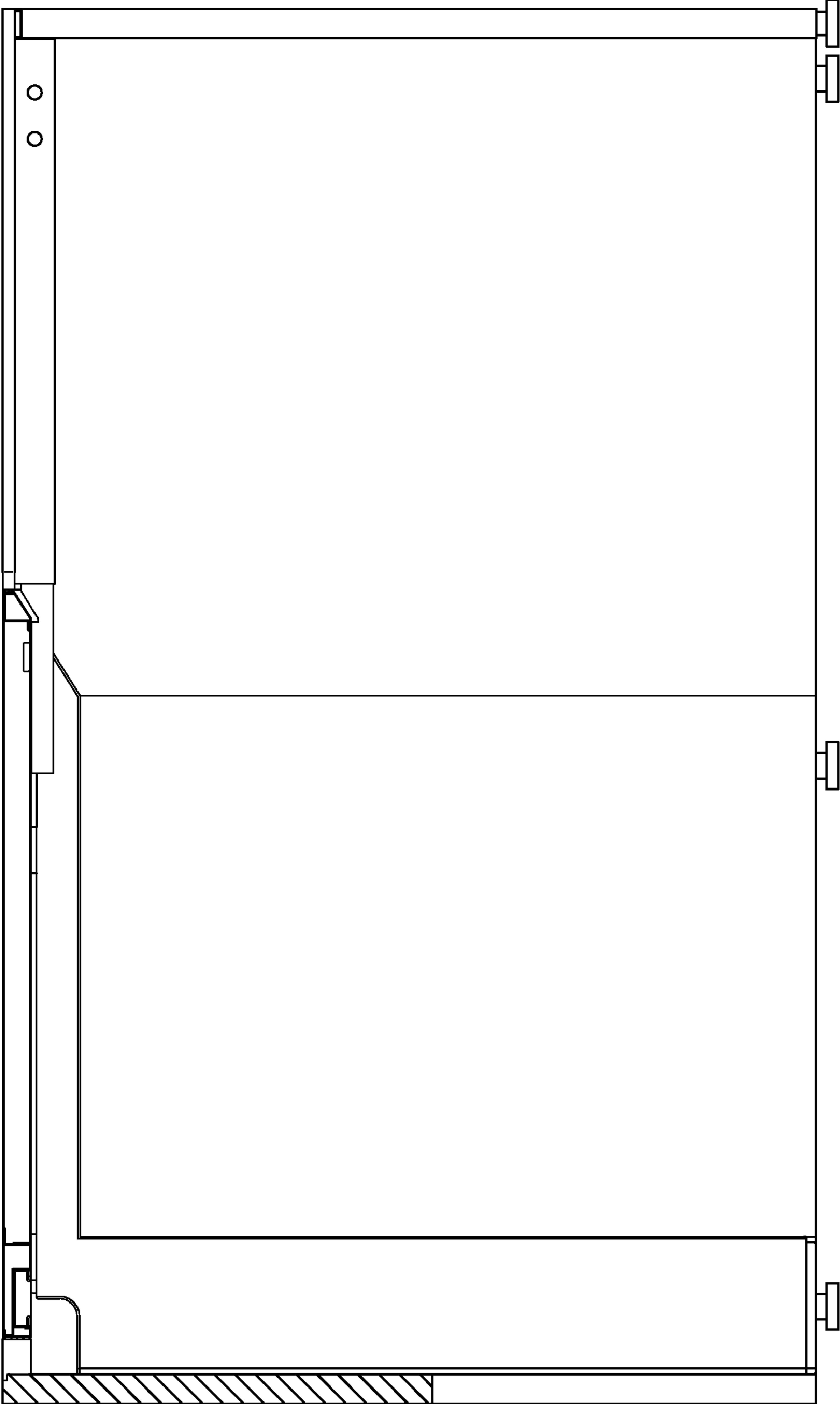

FIG. 5

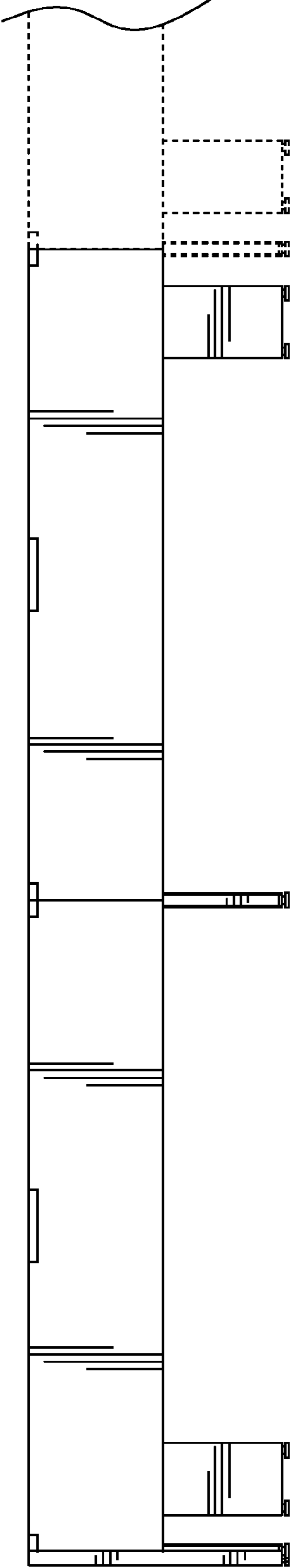

FIG. 6

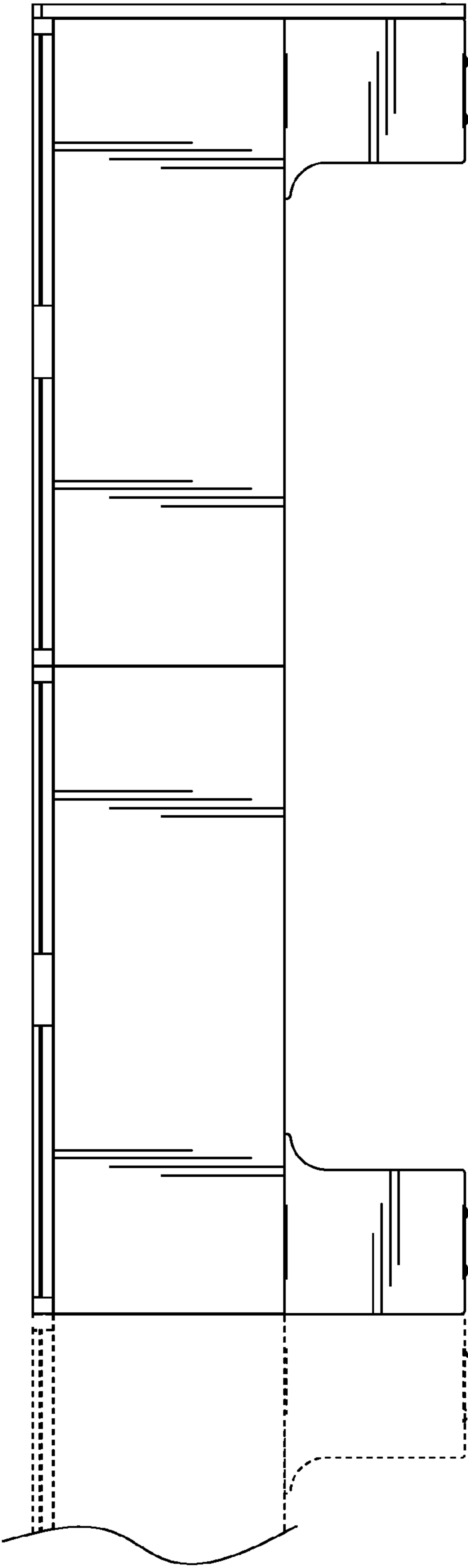

FIG. 7

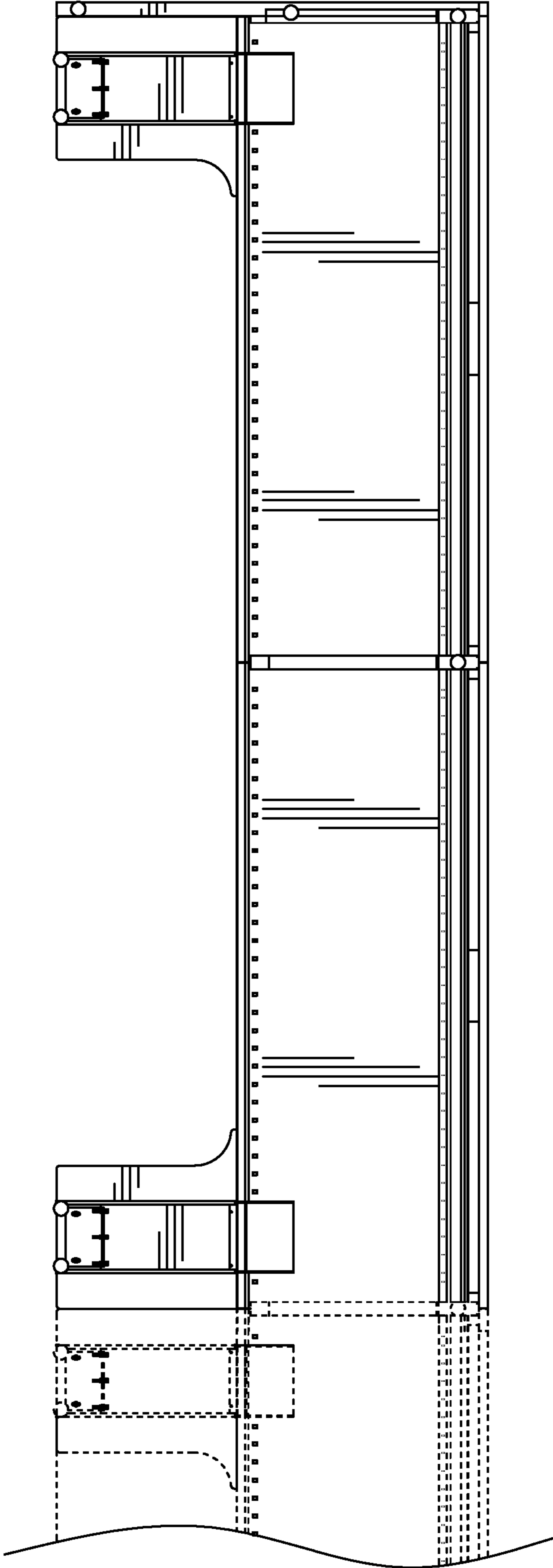

FIG. 8

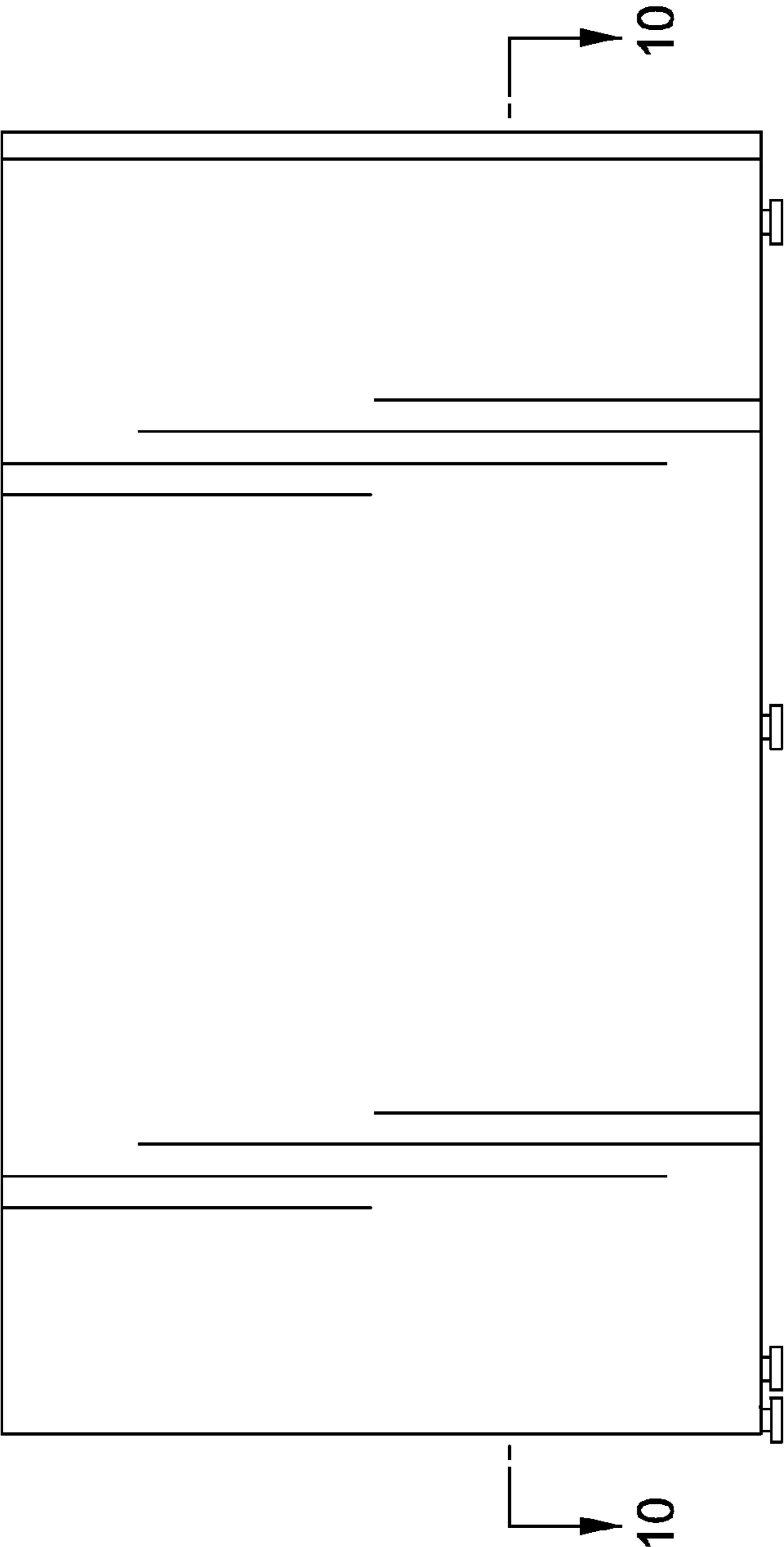

FIG. 9

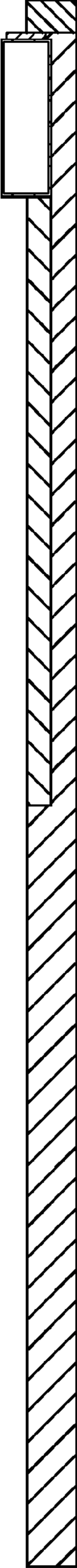

FIG. 10

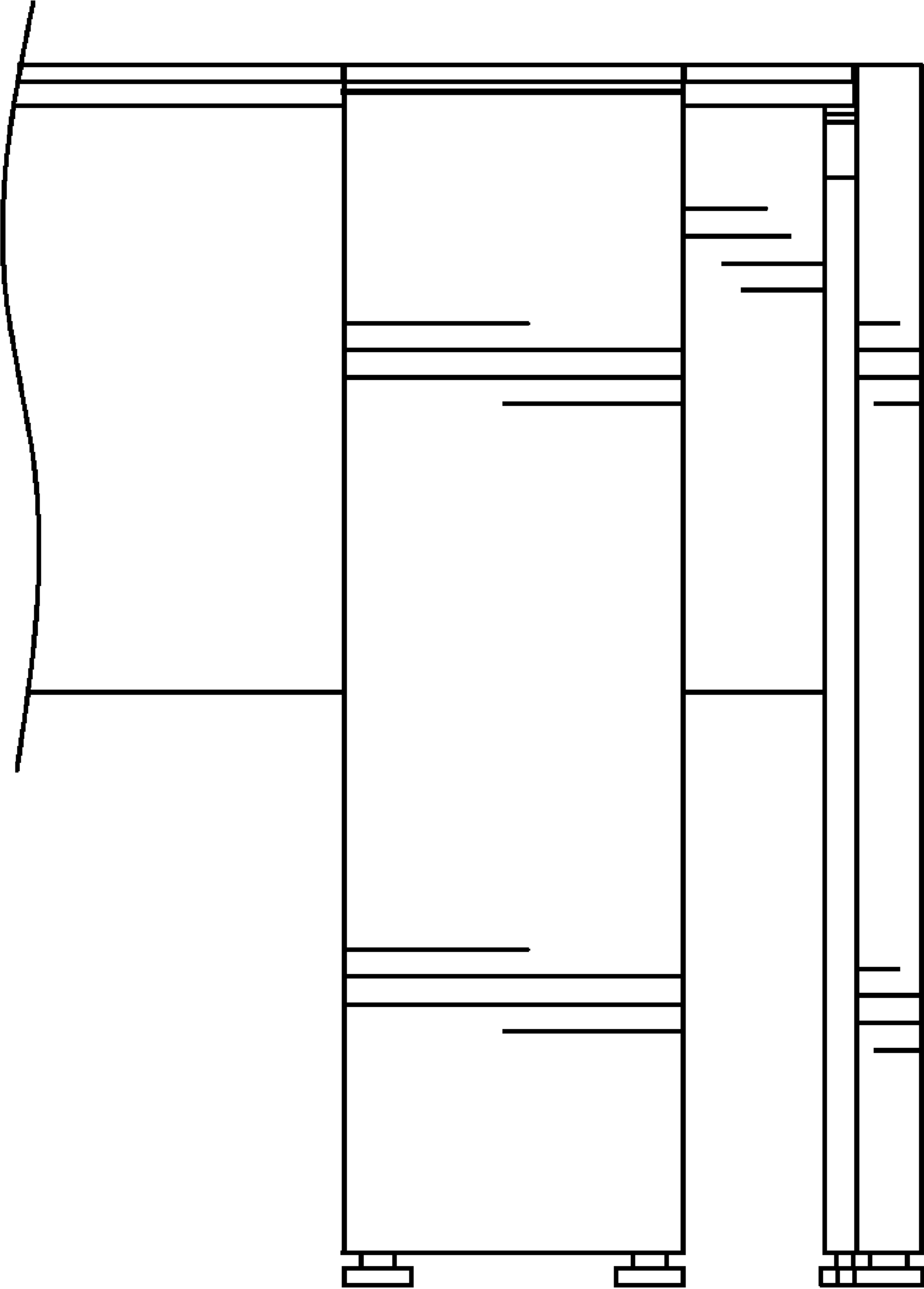

FIG. 11

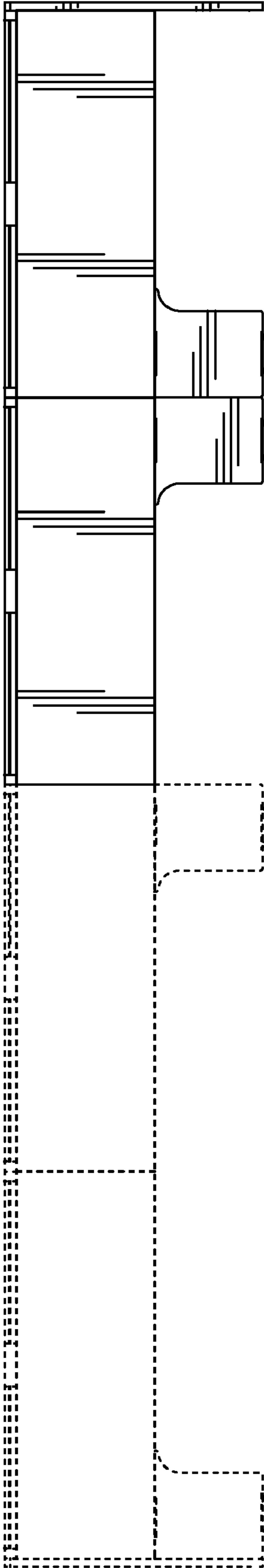

FIG. 12

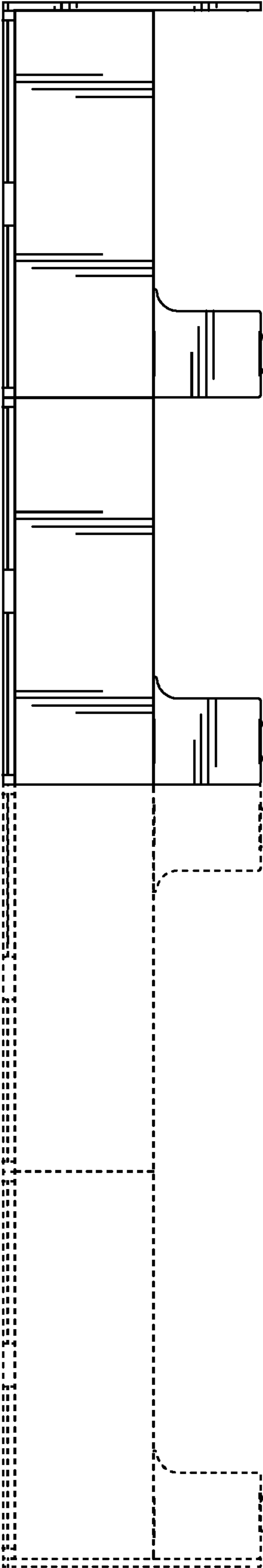

FIG. 13