



US00D610829S

(12) **United States Design Patent**
Nelsen et al.

(10) **Patent No.:** **US D610,829 S**
(45) **Date of Patent:** **** Mar. 2, 2010**

(54) **FOOD SERVICE CREDENZA**

(75) Inventors: **Randall P. Nelsen**, Alto, MI (US);
Brandon J. Walch, Grand Rapids, MI (US); **Robert J. Bockheim**, Grand Rapids, MI (US)

(73) Assignee: **Nucraft Furniture Company**, Comstock Park, MI (US)

(**) Term: **14 Years**

(21) Appl. No.: **29/338,442**

(22) Filed: **Jun. 11, 2009**

(51) **LOC (9) Cl.** **06-04**

(52) **U.S. Cl.** **D6/396; D6/466**

(58) **Field of Classification Search** D6/396,
D6/432-448, 422-428; 312/204, 257, 194-196
See application file for complete search history.

(56) **References Cited**

U.S. PATENT DOCUMENTS

D292,152 S	*	10/1987	Meyers	D6/450
D312,738 S	*	12/1990	Newhouse	D6/446
D343,072 S	*	1/1994	Schulman et al.	D6/425
D414,628 S	*	10/1999	Gager et al.	D6/445
D477,474 S	*	7/2003	Milligan	D6/446
D575,549 S	*	8/2008	Woods	D6/422
D591,979 S	*	5/2009	Singler et al.	D6/449
D592,887 S	*	5/2009	Mischkulnig	D6/436

* cited by examiner

Primary Examiner—Philip S Hyder

Assistant Examiner—Sydney R Buffalow

(74) *Attorney, Agent, or Firm*—Van Dyke, Gardner, Linn & Burkhardt LLP

(57) **CLAIM**

The ornamental design for the food service credenza, as shown and described.

DESCRIPTION

FIG. 1 is a front perspective view of a food service credenza in accordance with the present invention, shown in a closed state;

FIG. 2 is a rear perspective view of the food service credenza of FIG. 1;

FIG. 3 is a front elevation of the food service credenza of FIG. 1;

FIG. 4 is a rear elevation of the food service credenza of FIG. 1;

FIG. 5 is a side elevation of the food service credenza of FIG. 1;

FIG. 6 is an opposite side elevation of the food service credenza of FIG. 1;

FIG. 7 is a top plan view of the food service credenza of FIG. 1;

FIG. 8 is a bottom plan view of the food service credenza of FIG. 1;

FIG. 9 is a front perspective view of the food service credenza, shown in an opened state;

FIG. 10 is a rear perspective view of the food service credenza of FIG. 9;

FIG. 11 is a front elevation of the food service credenza of FIG. 9;

FIG. 12 is a rear elevation of the food service credenza of FIG. 9;

FIG. 13 is a side elevation of the food service credenza of FIG. 9;

FIG. 14 is an opposite side elevation of the food service credenza of FIG. 9;

FIG. 15 is a top plan view of the food service credenza of FIG. 9; and,

FIG. 16 is a bottom plan view of the food service credenza of FIG. 9.

The broken lines in the drawings are for illustrative purposes only and form no part of the claimed design.

1 Claim, 14 Drawing Sheets

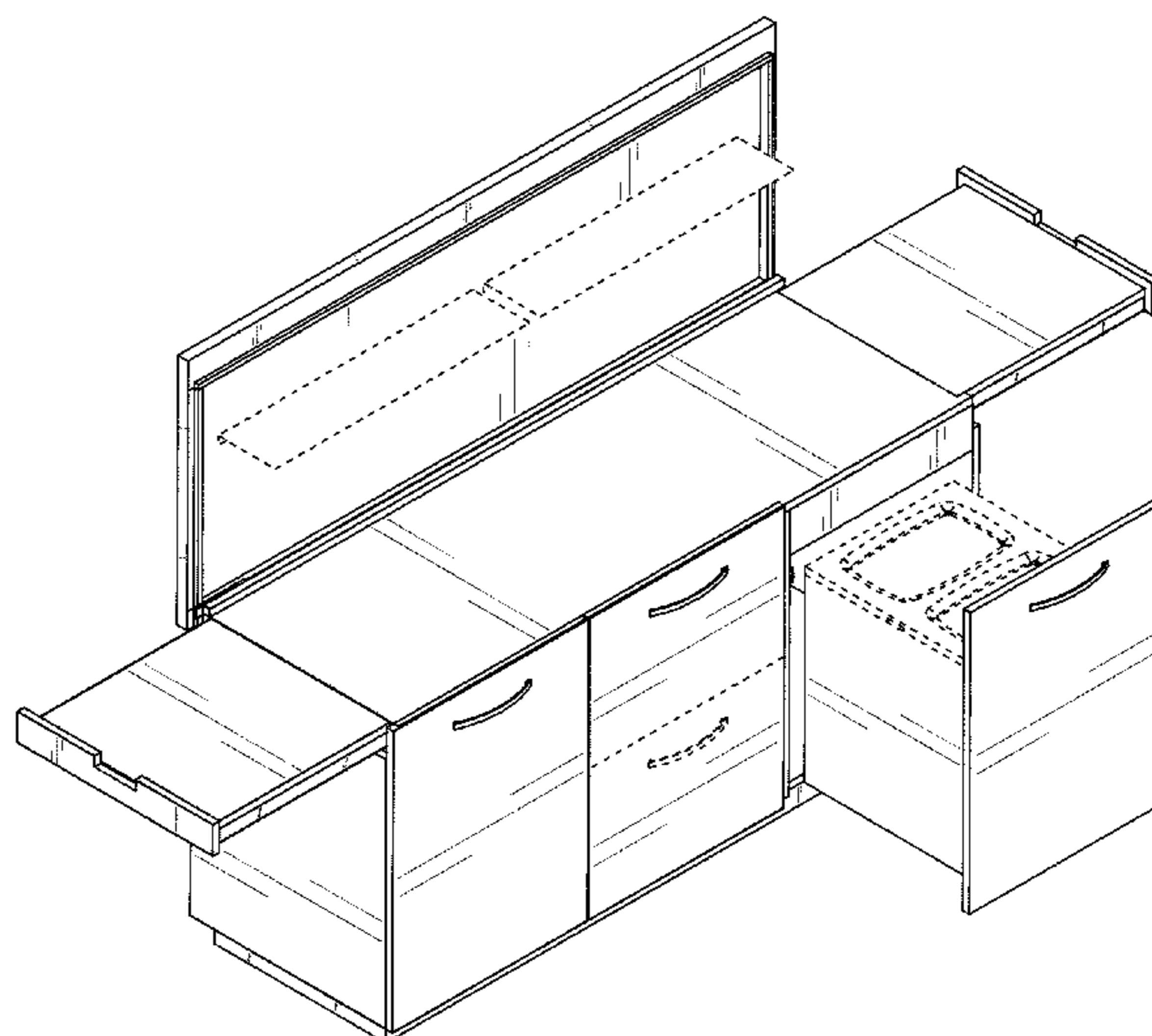
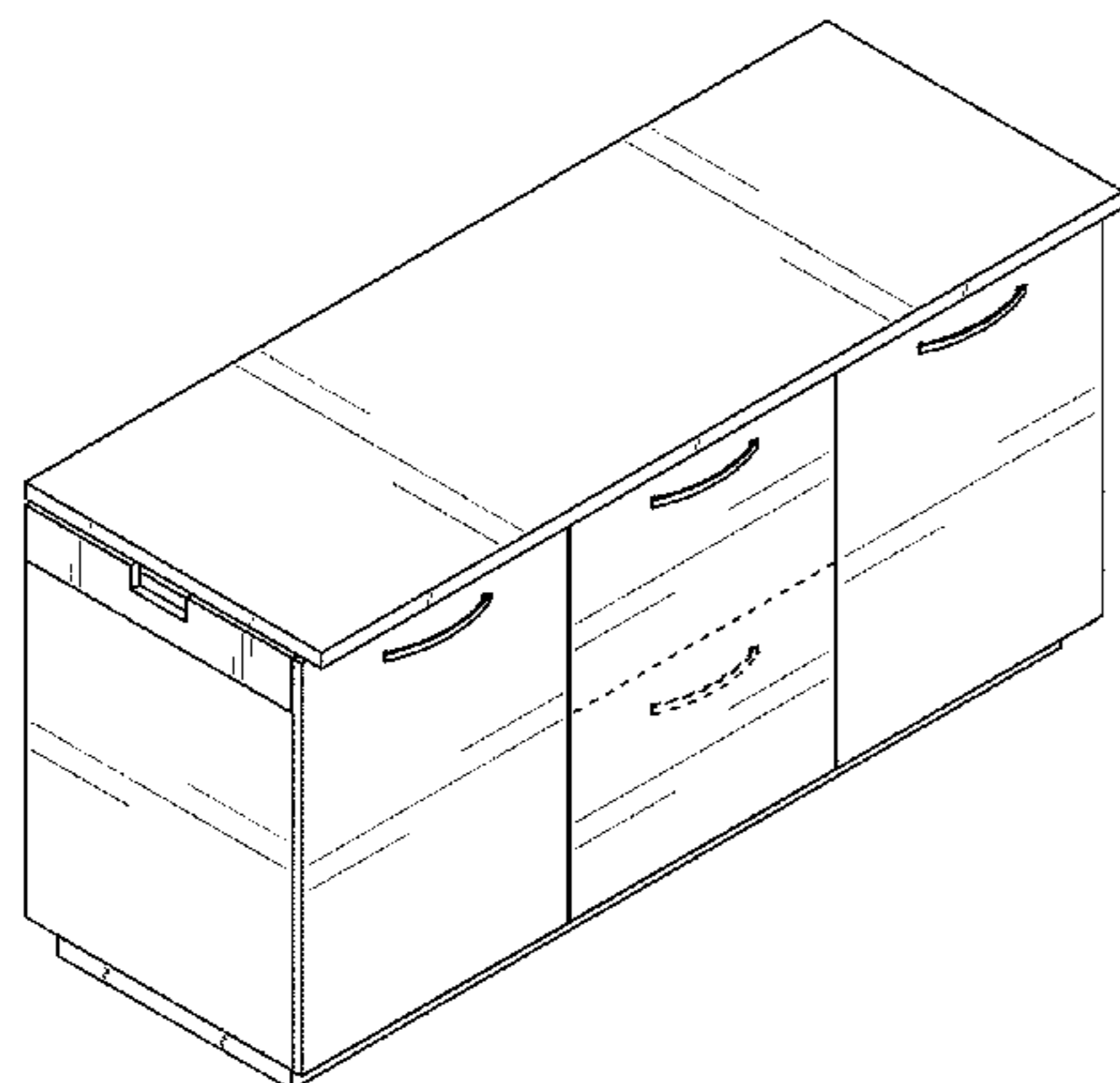

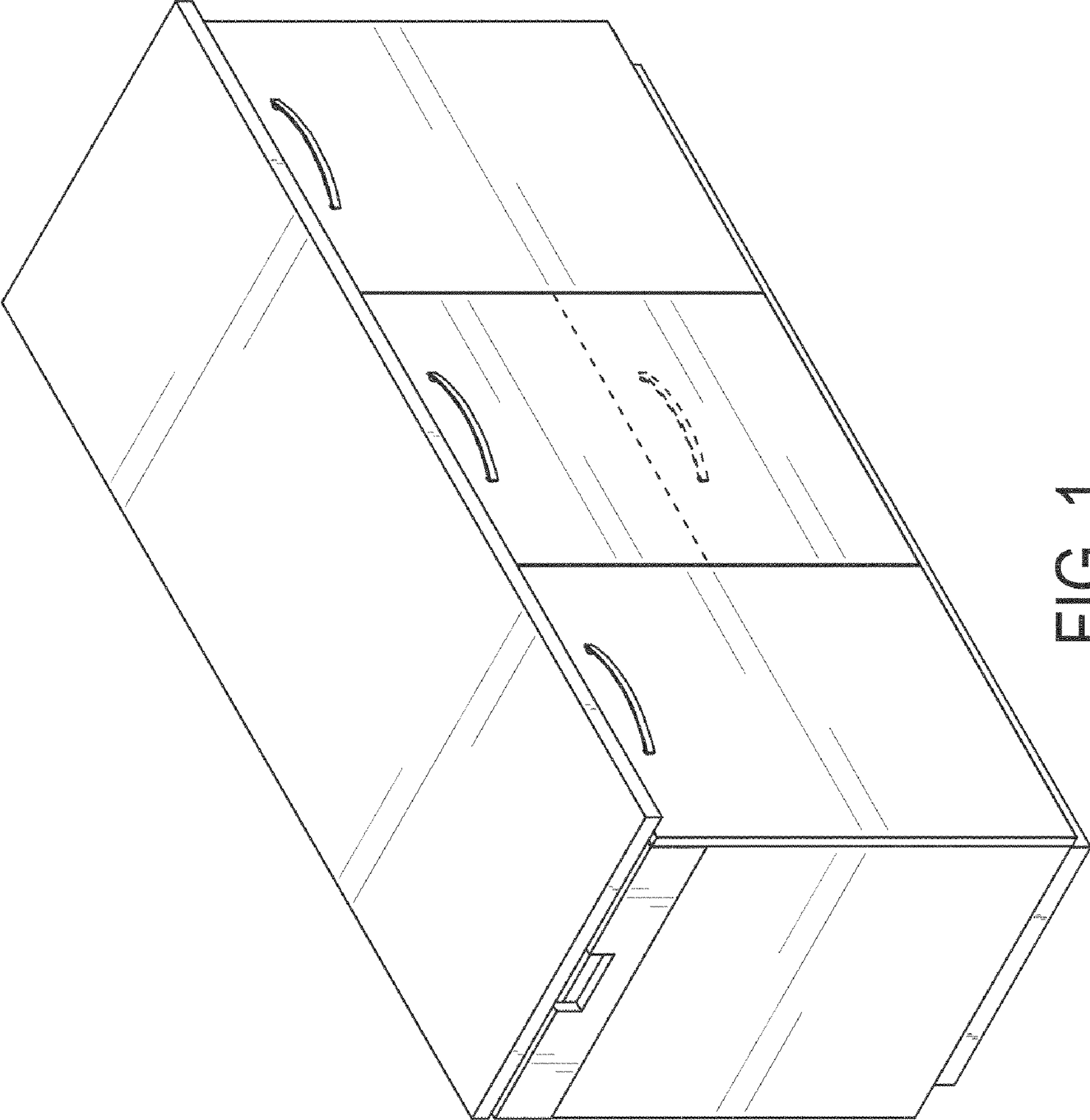

FIG. 1

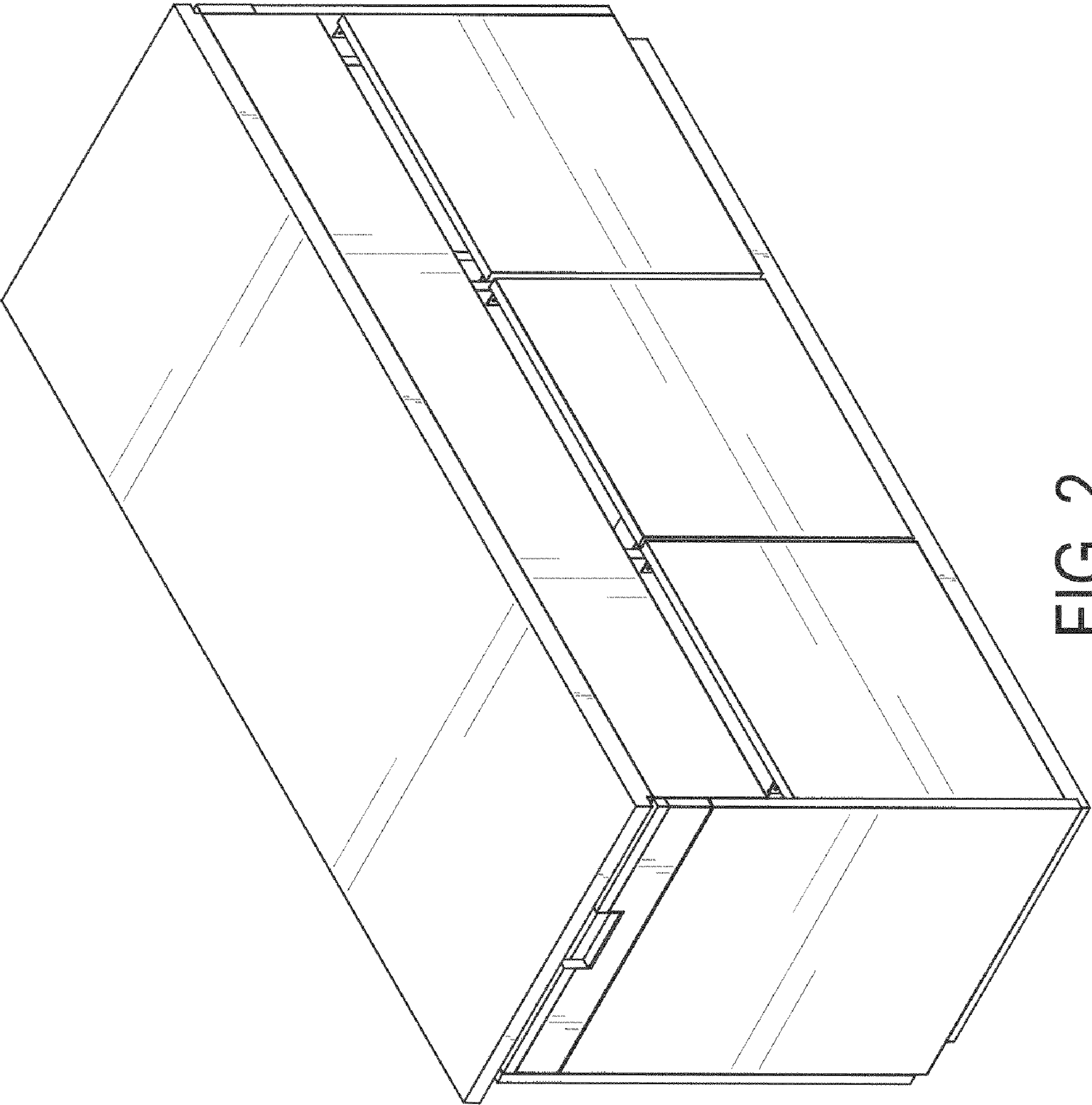

FIG. 2

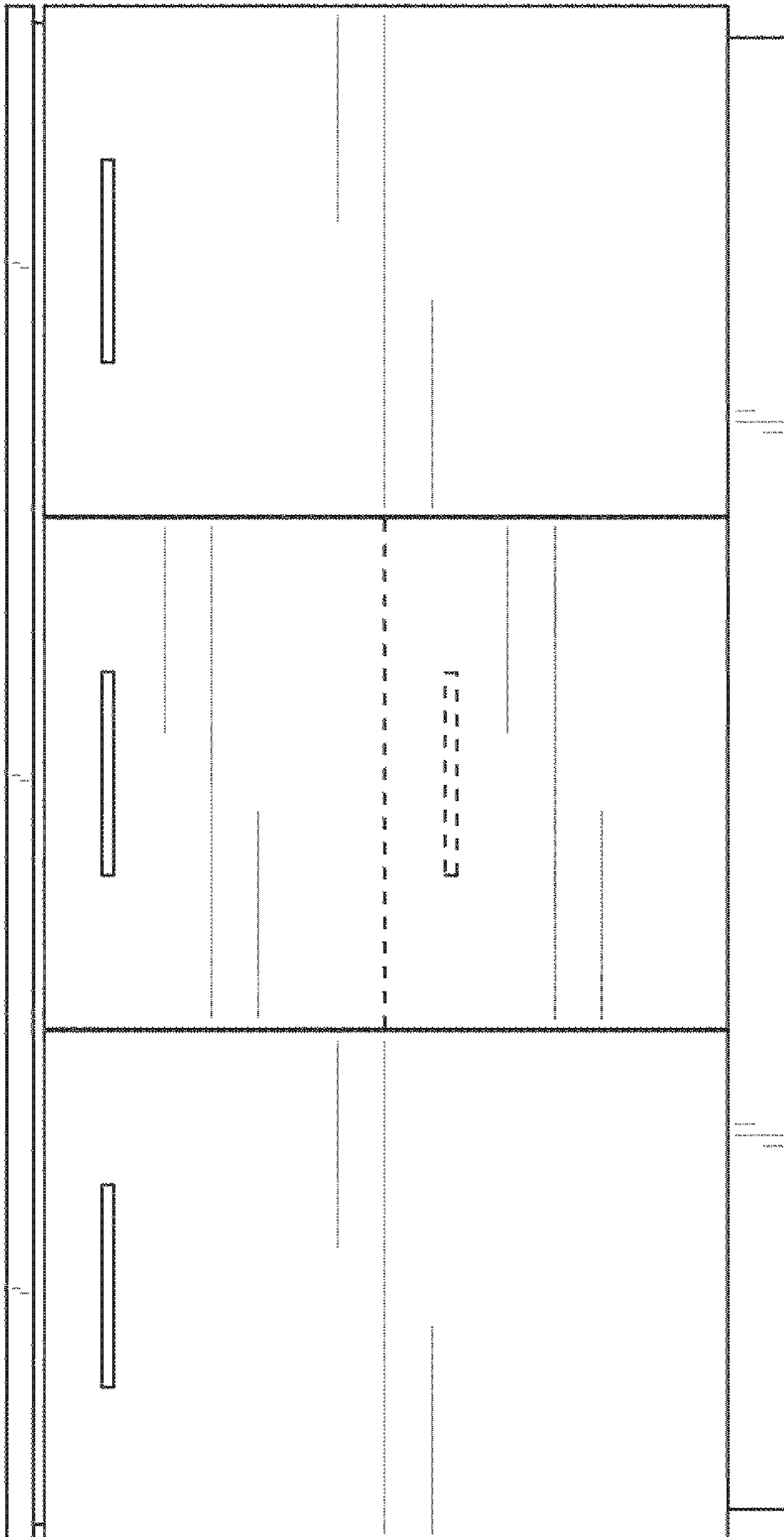

FIG. 3

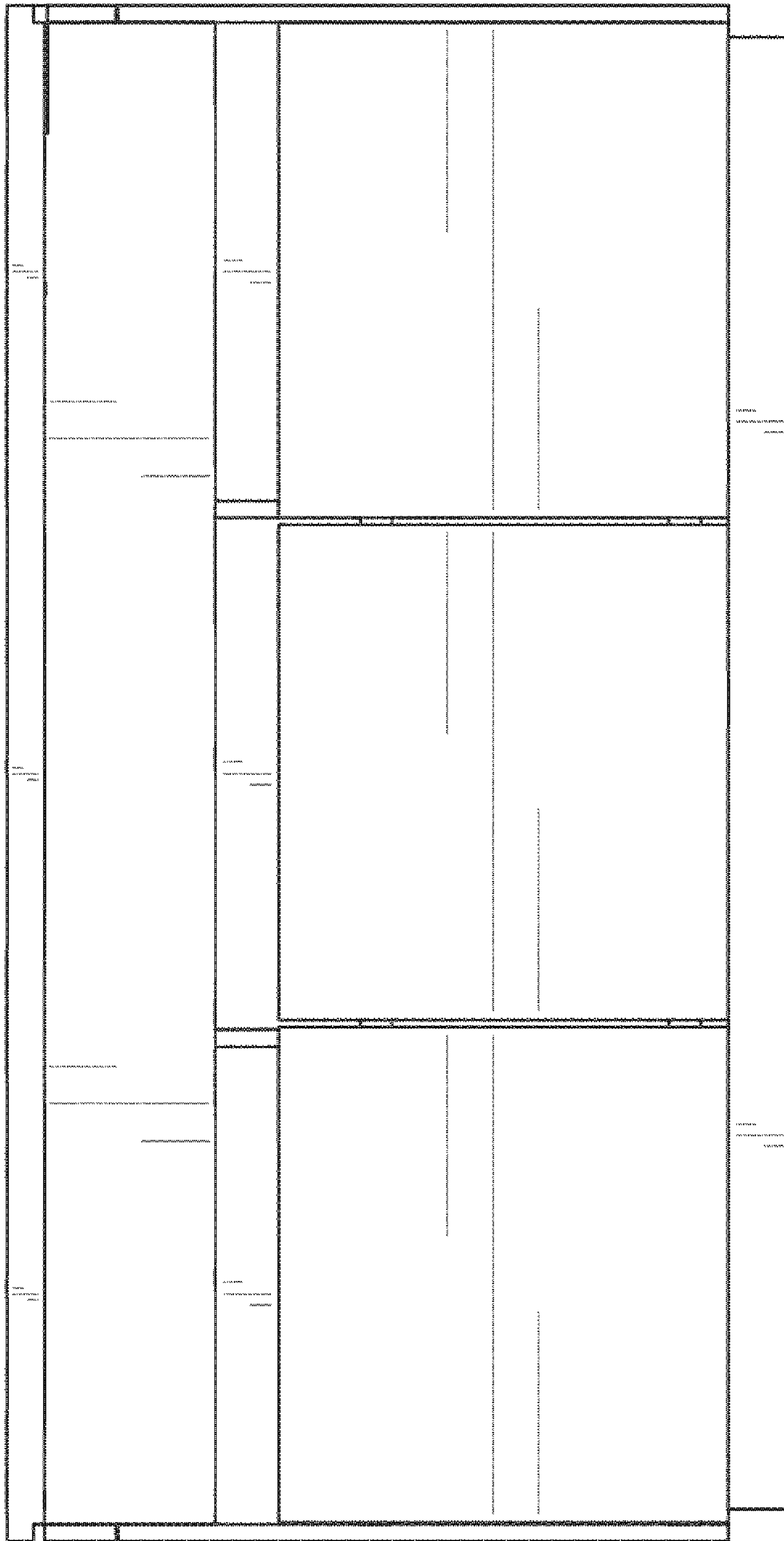

FIG. 4

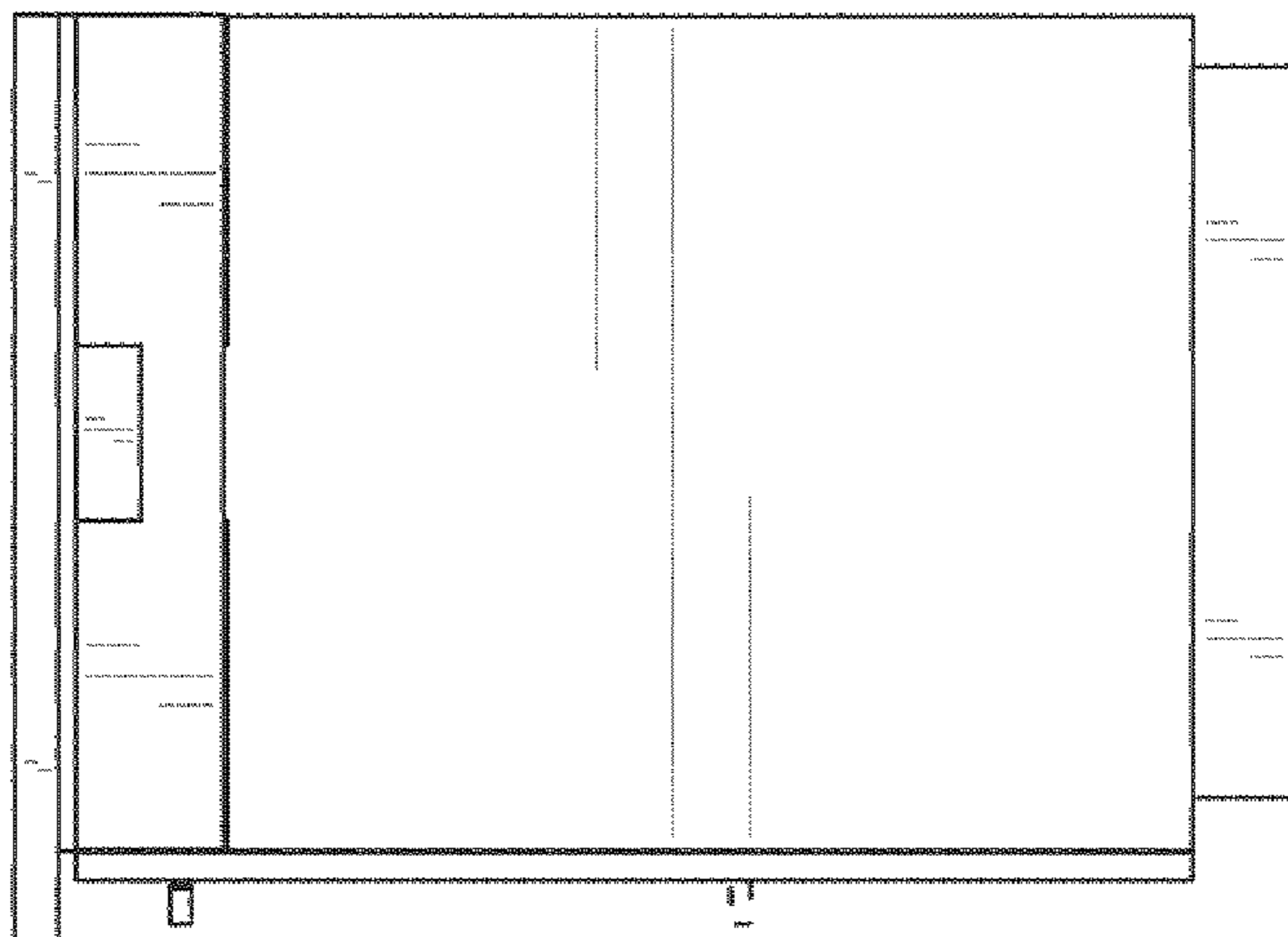

FIG. 5

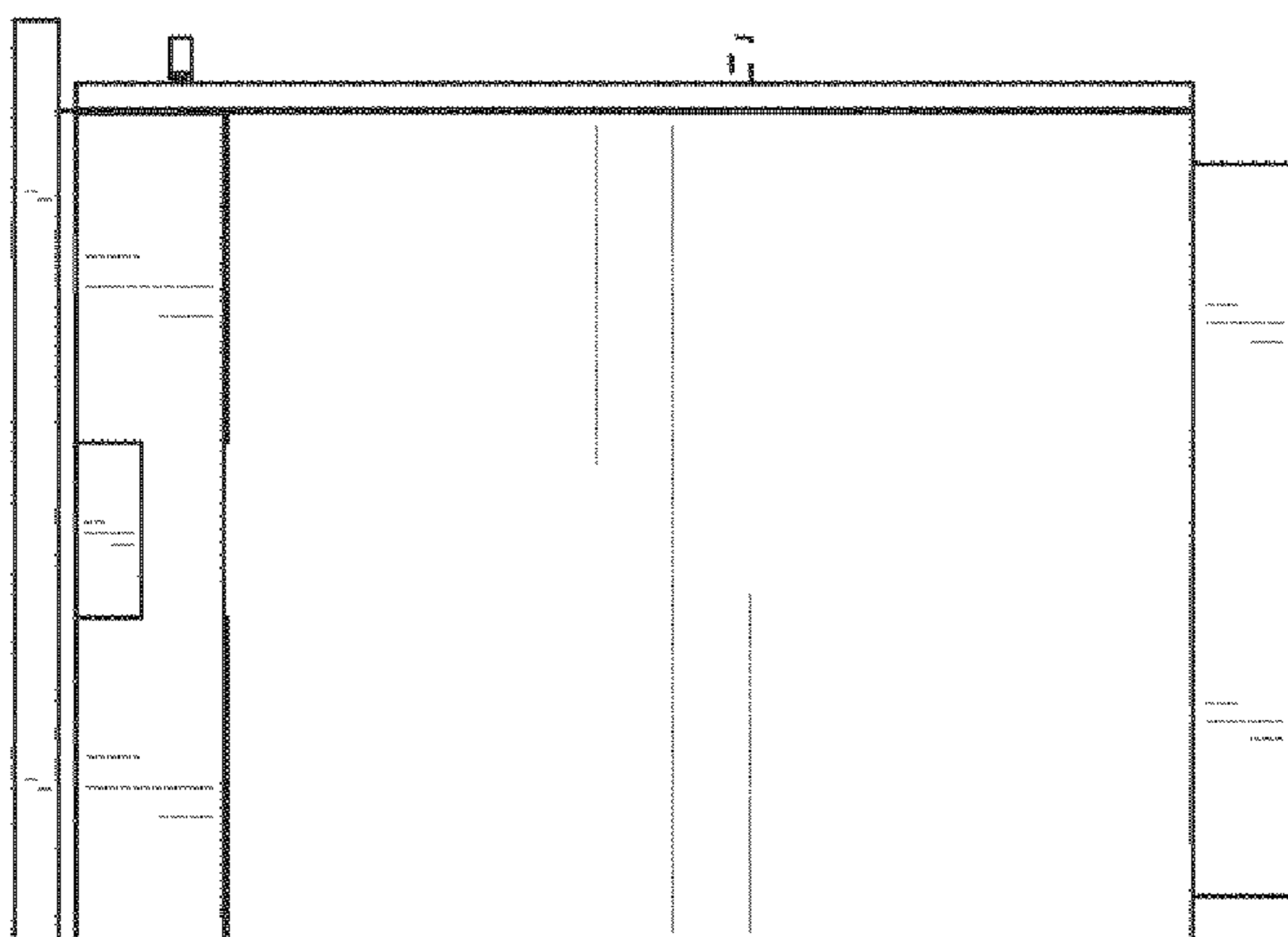

FIG. 6

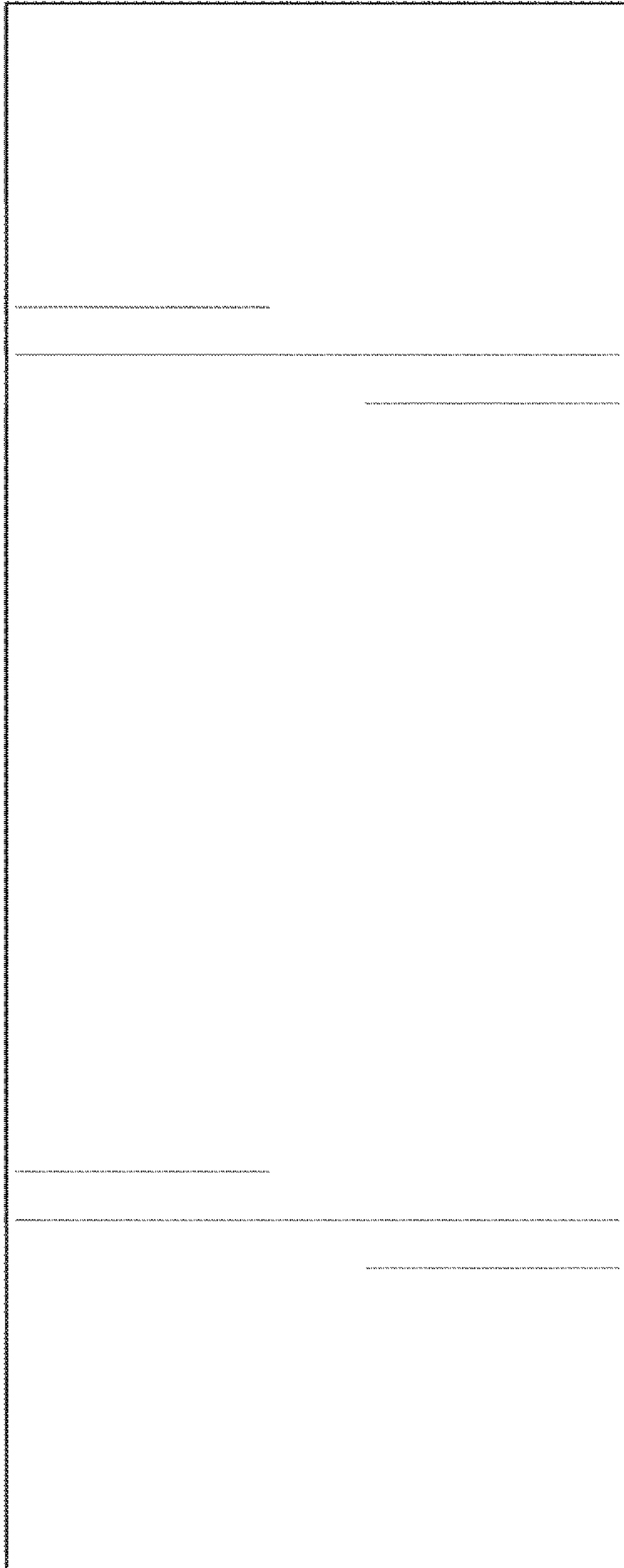

FIG. 7

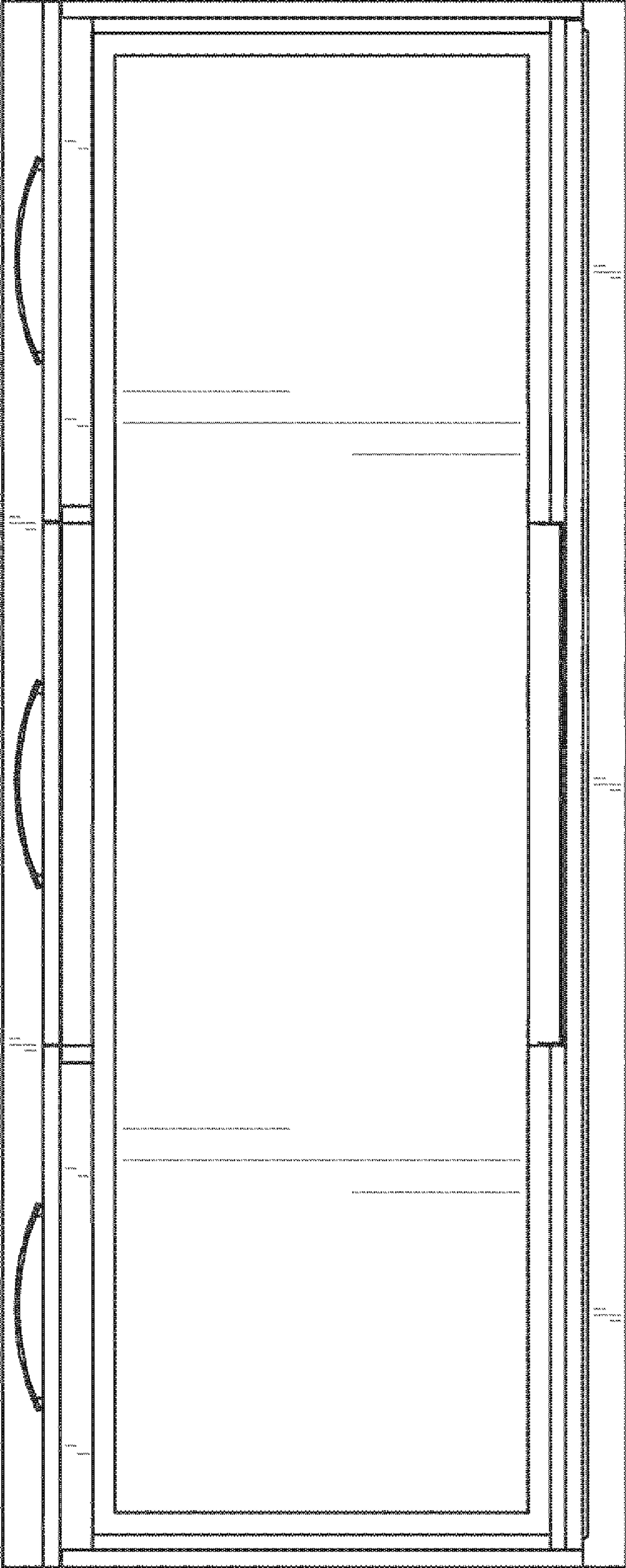

FIG. 8

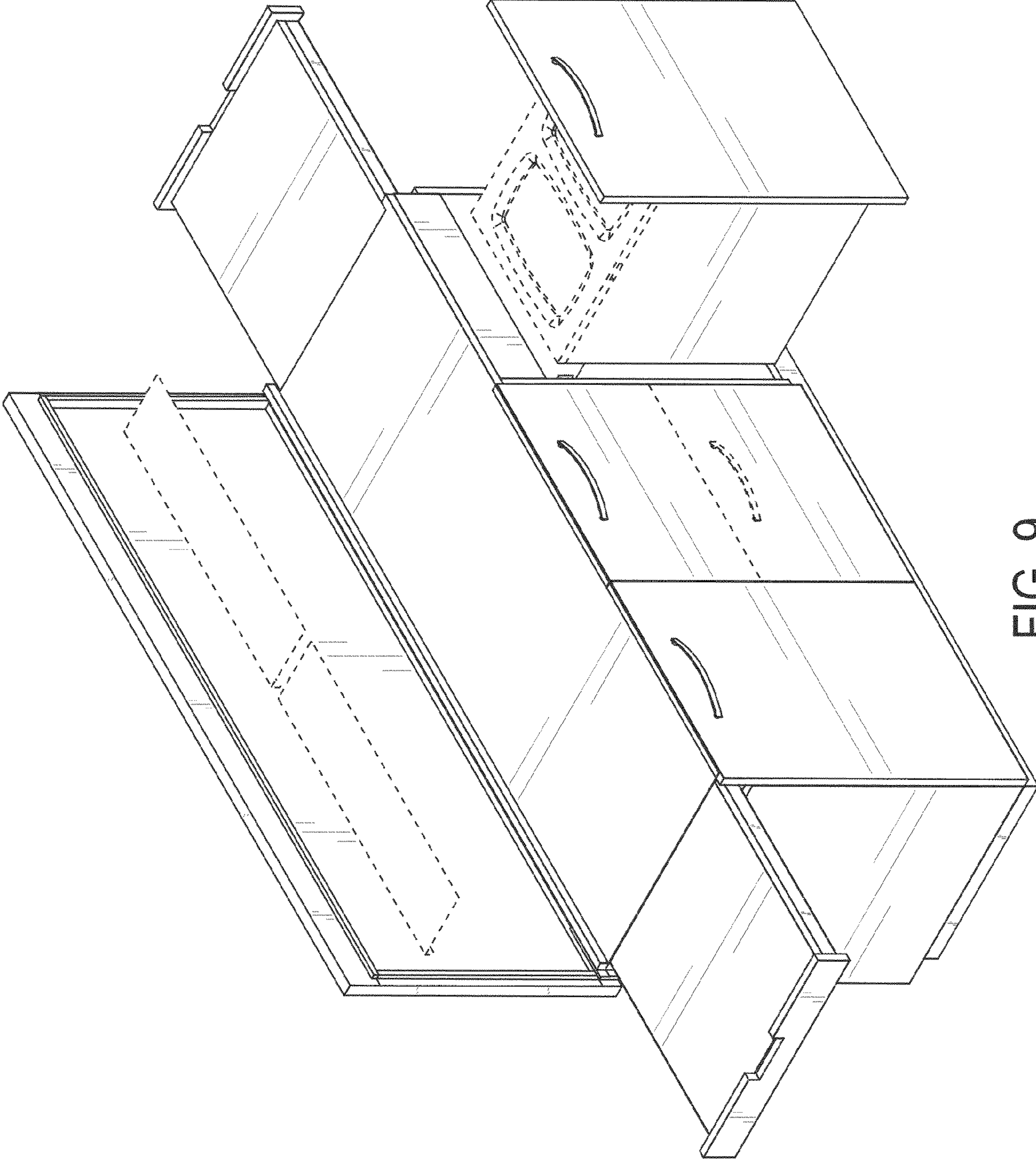

FIG. 9

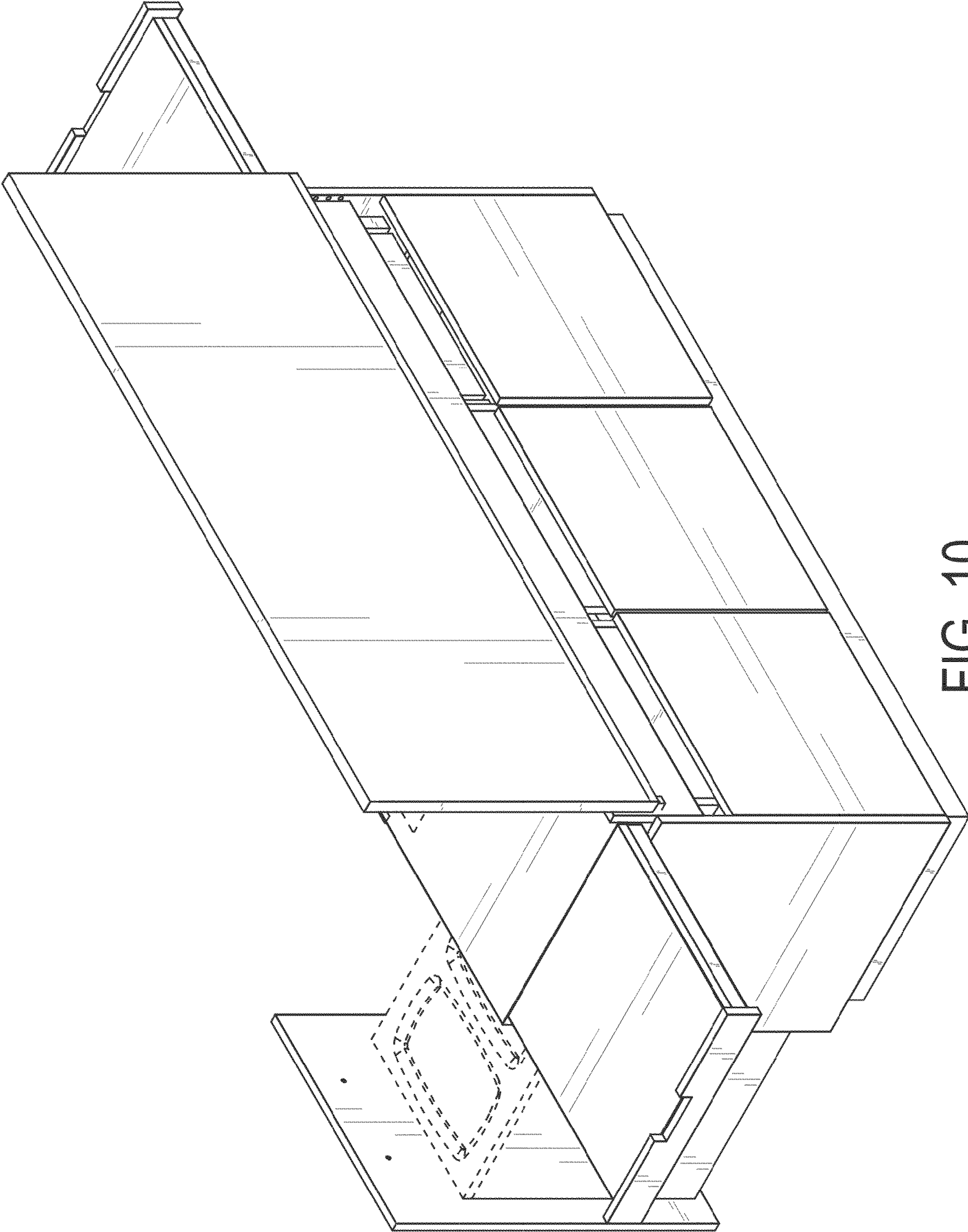

FIG. 10

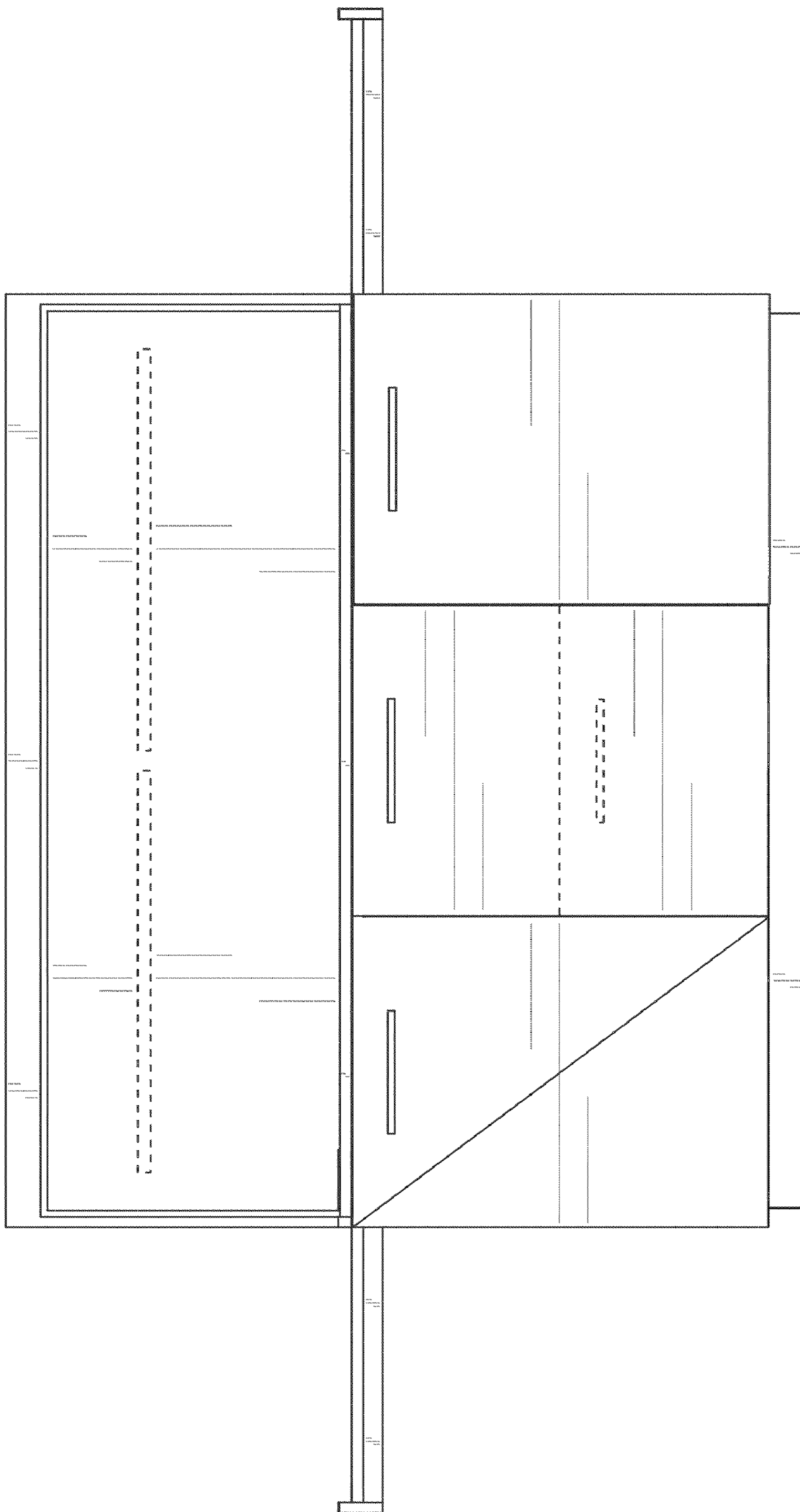

FIG. 11

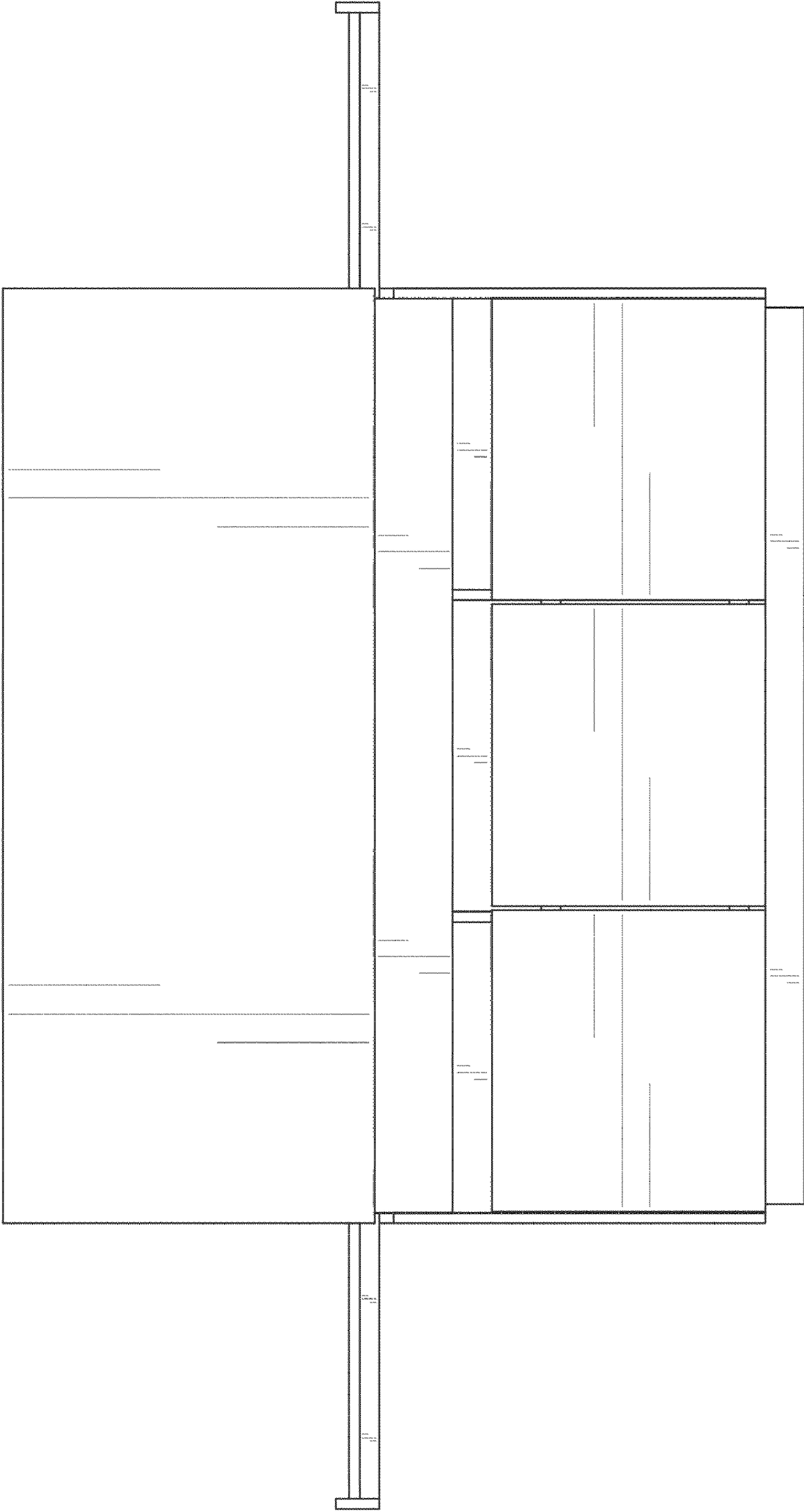

FIG. 12

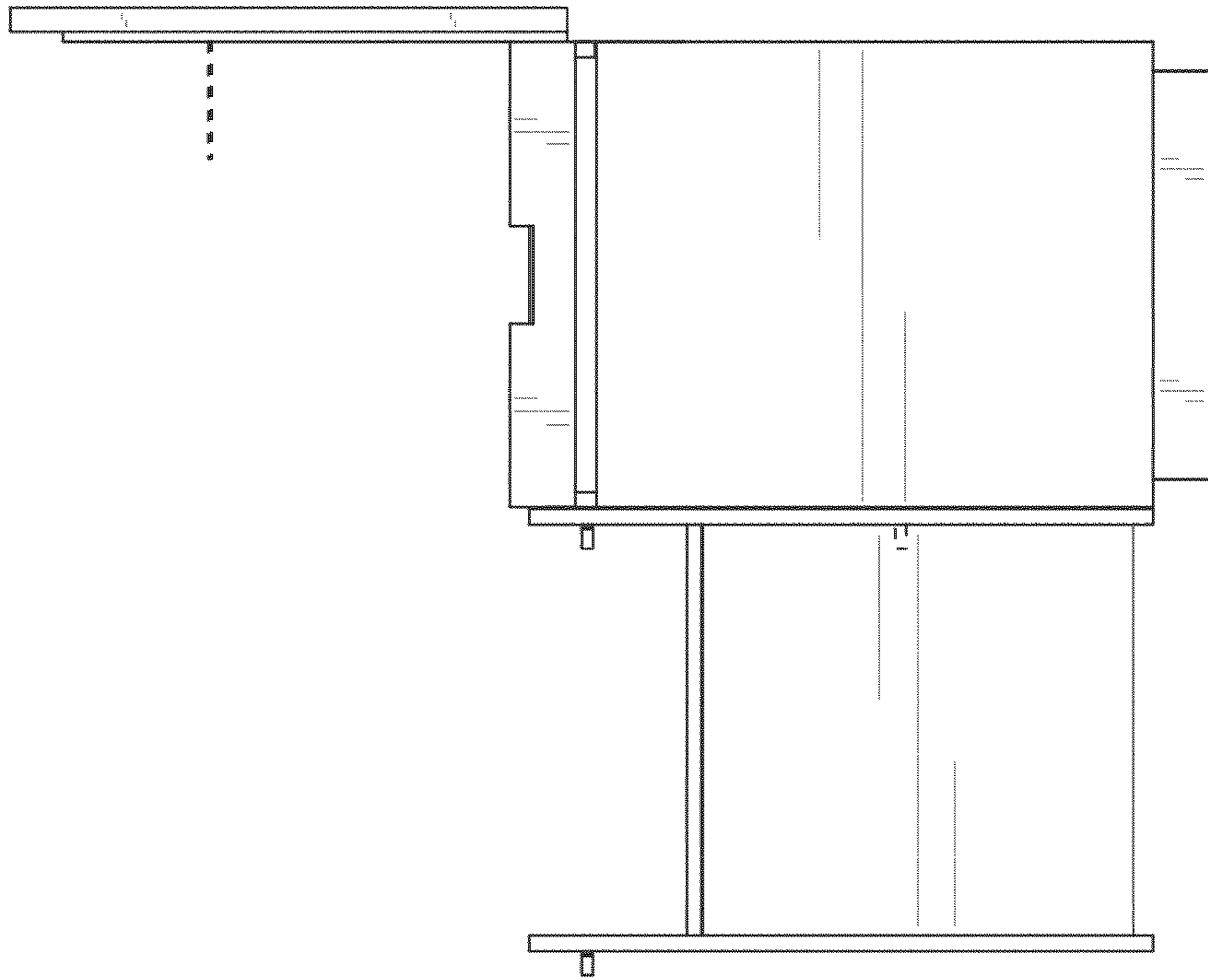

FIG. 14

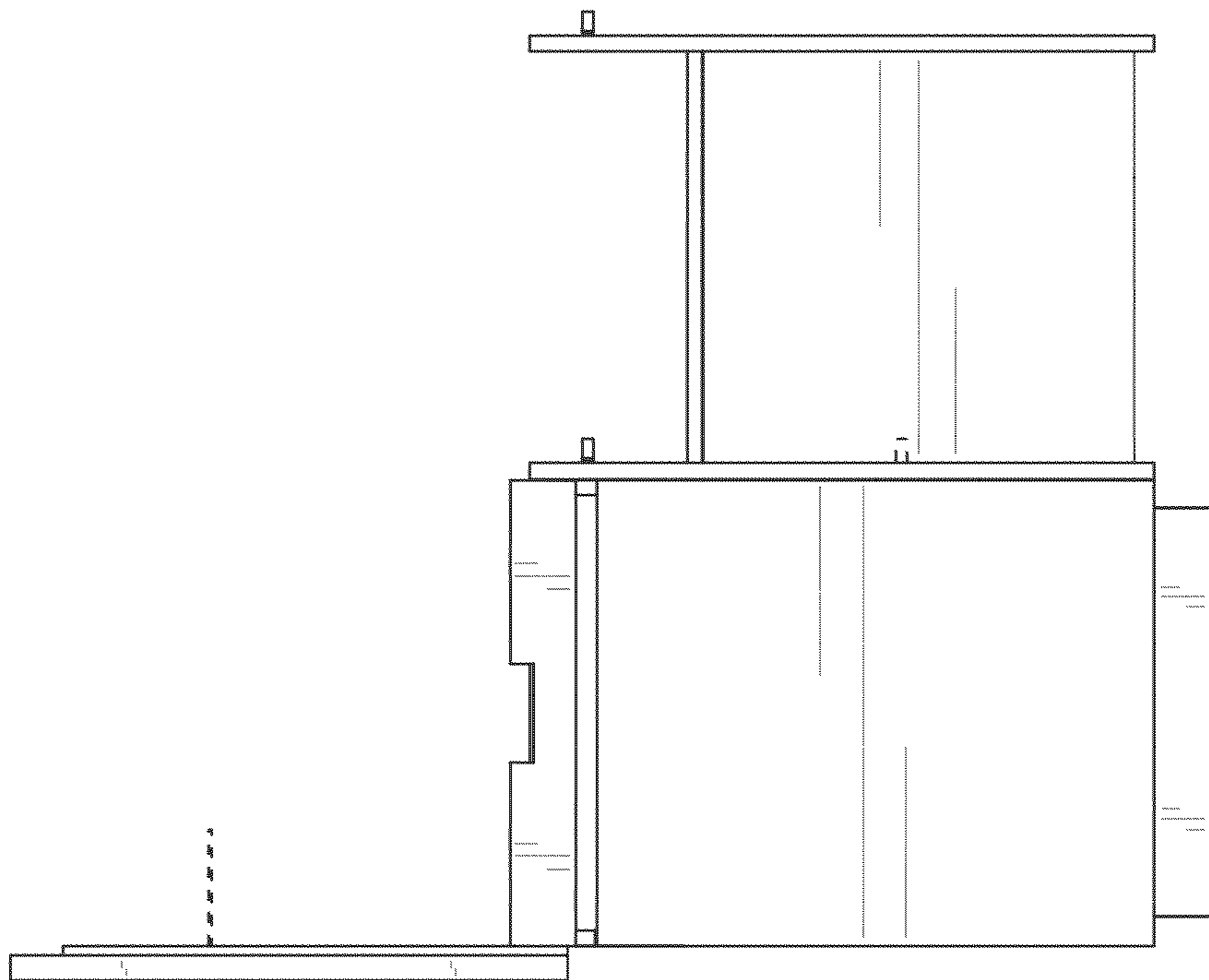

FIG. 13

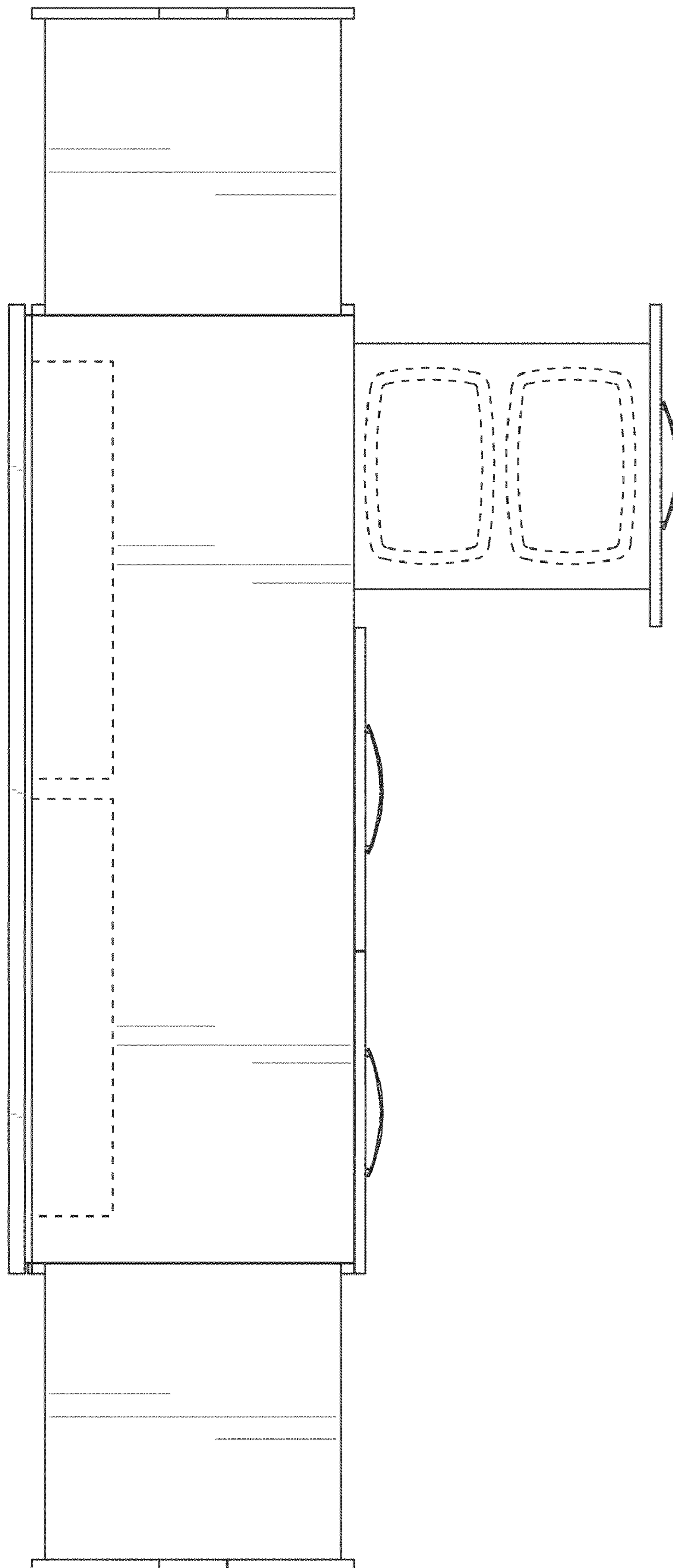

FIG. 15

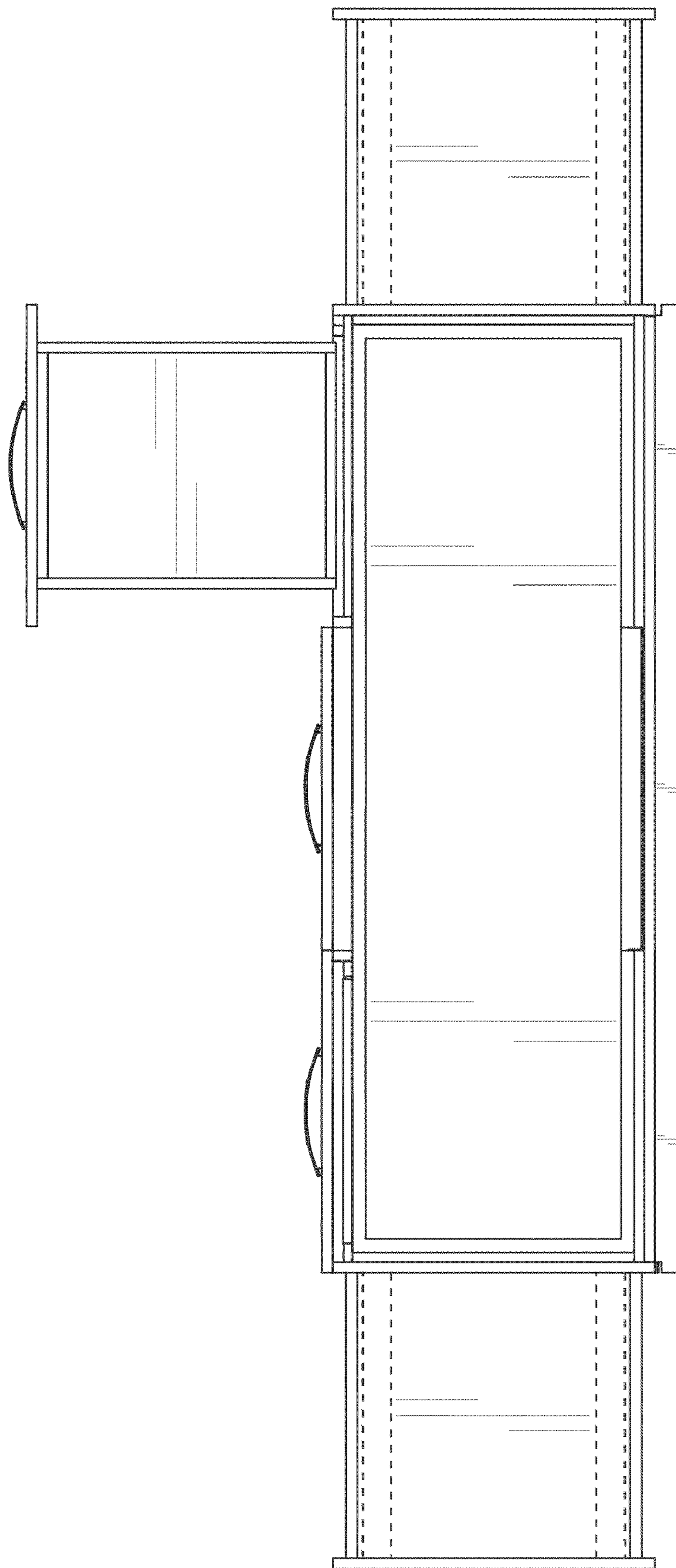

FIG. 16