



US00D610796S

(12) **United States Design Patent**  
**Siegel**

(10) **Patent No.:** **US D610,796 S**

(45) **Date of Patent:** **\*\* Mar. 2, 2010**

(54) **MEDICATION DISPENSER**

*Primary Examiner*—Catherine R Oliver  
(74) *Attorney, Agent, or Firm*—Myron Amer PC

(76) **Inventor:** **Frederic S. Siegel**, 3265 Lawson Blvd.,  
Oceanside, NY (US) 11572

(57) **CLAIM**

(\*\*) **Term:** **14 Years**

The ornamental design for a medication dispenser, as shown and described.

(21) **Appl. No.:** **29/315,249**

(22) **Filed:** **Jun. 9, 2009**

(51) **LOC (9) Cl.** ..... **03-01**

(52) **U.S. Cl.** ..... **D3/203.2**

(58) **Field of Classification Search** ..... D3/203.2,  
D3/203.1, 203.3, 203.4, 201, 205, 294; D9/730-731,  
D9/449, 428, 339, 416-421; 206/530-540,  
206/581

See application file for complete search history.

**DESCRIPTION**

FIG. 1 is a perspective view of a medication dispenser showing my new design;

FIG. 2 is a top view thereof;

FIG. 3 is a bottom view thereof;

FIG. 4 is a right side elevational view thereof, the left side elevational view being a mirror image thereof;

FIG. 5 is a front elevational view thereof; and,

FIG. 6 is a rear elevational view thereof.

The broken line showing of environment in the drawings is included for the purpose of illustrating only and forms no part of the claimed design.

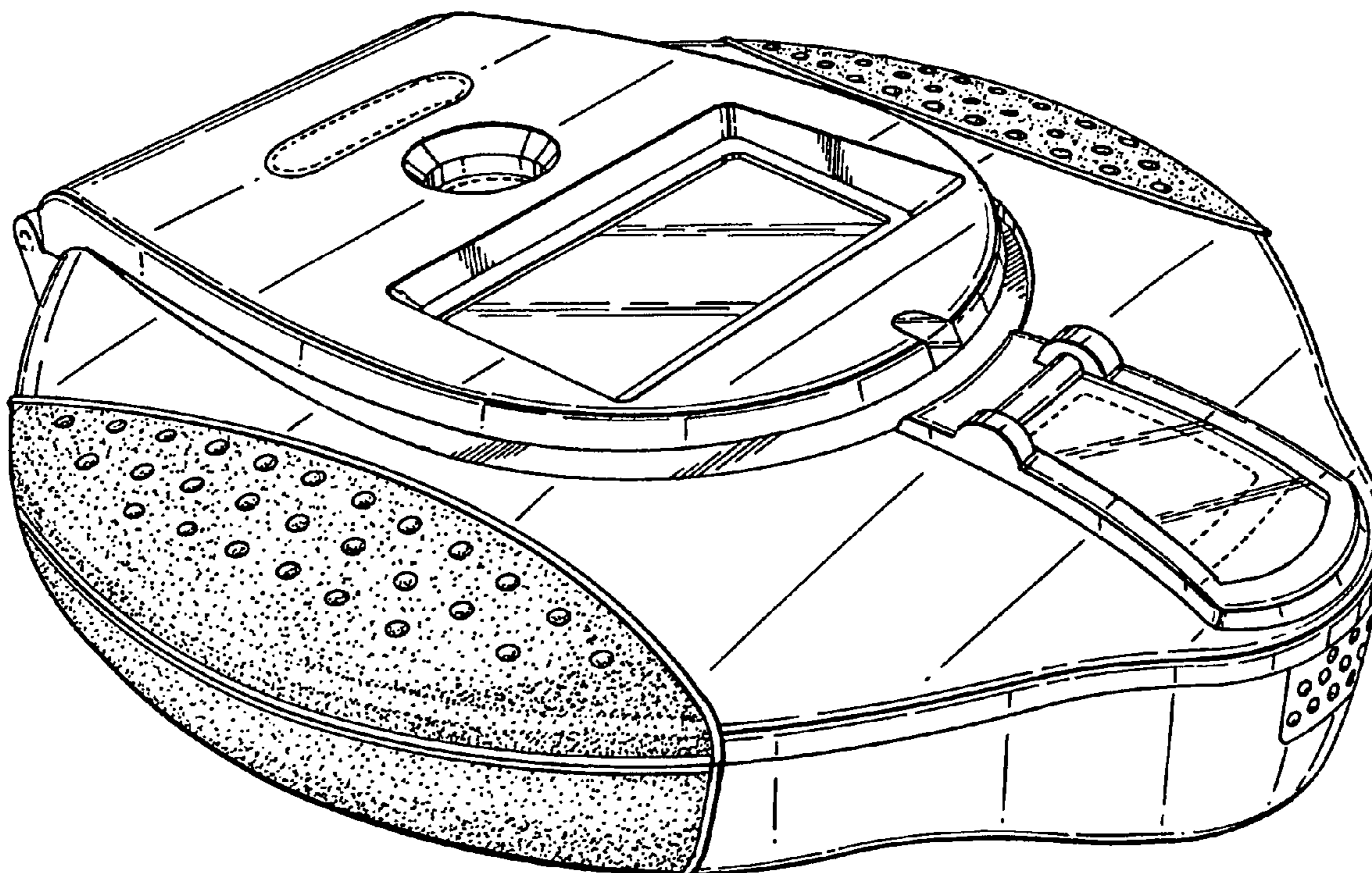
(56) **References Cited**

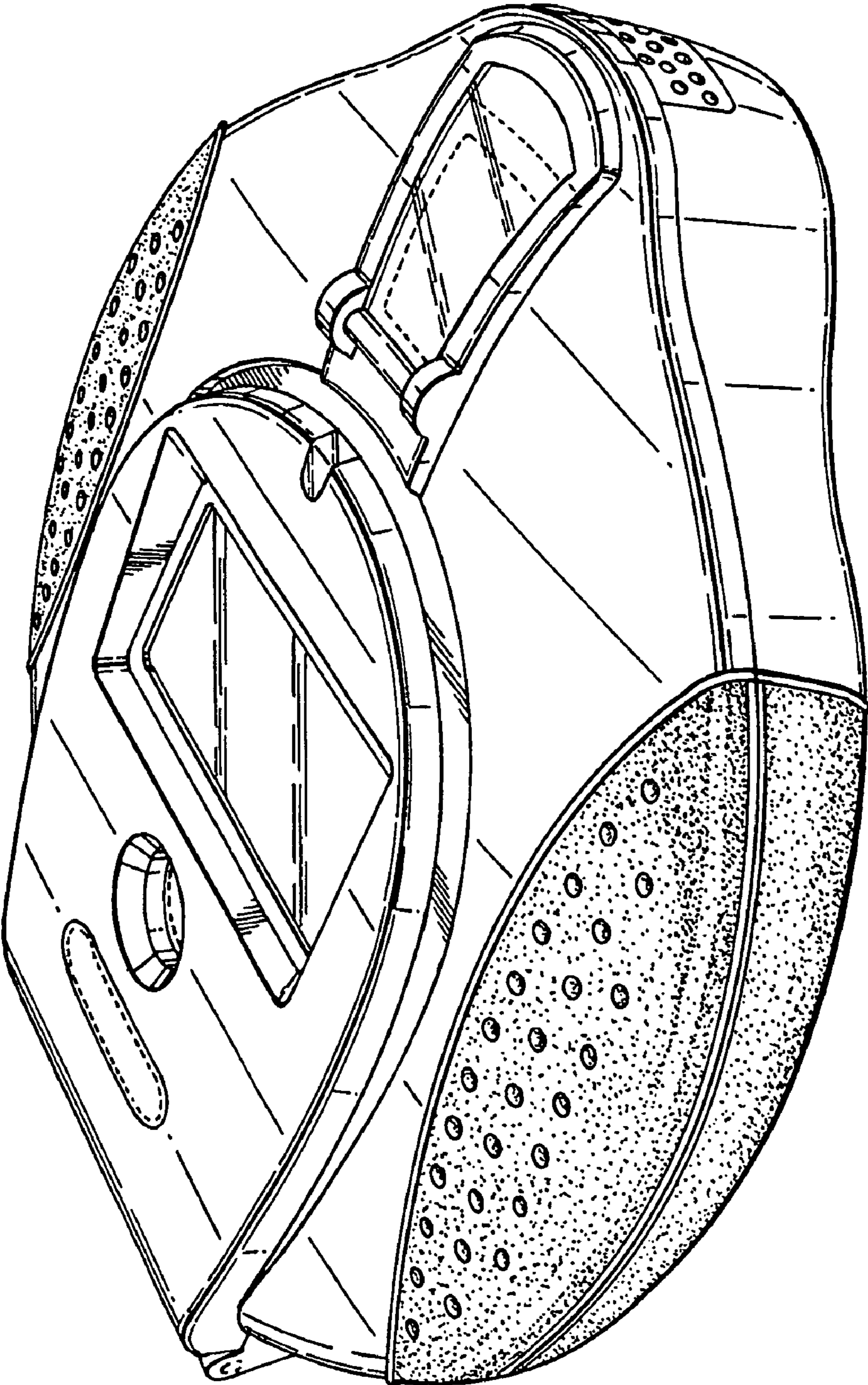
**U.S. PATENT DOCUMENTS**

D540,038 S *	4/2007	Hussaini et al.	.....	D3/294
D547,940 S *	8/2007	Sandy	.....	D3/203.2
D570,595 S *	6/2008	Chue	.....	D3/203.3
D602,245 S *	10/2009	Christie et al.	.....	D3/205

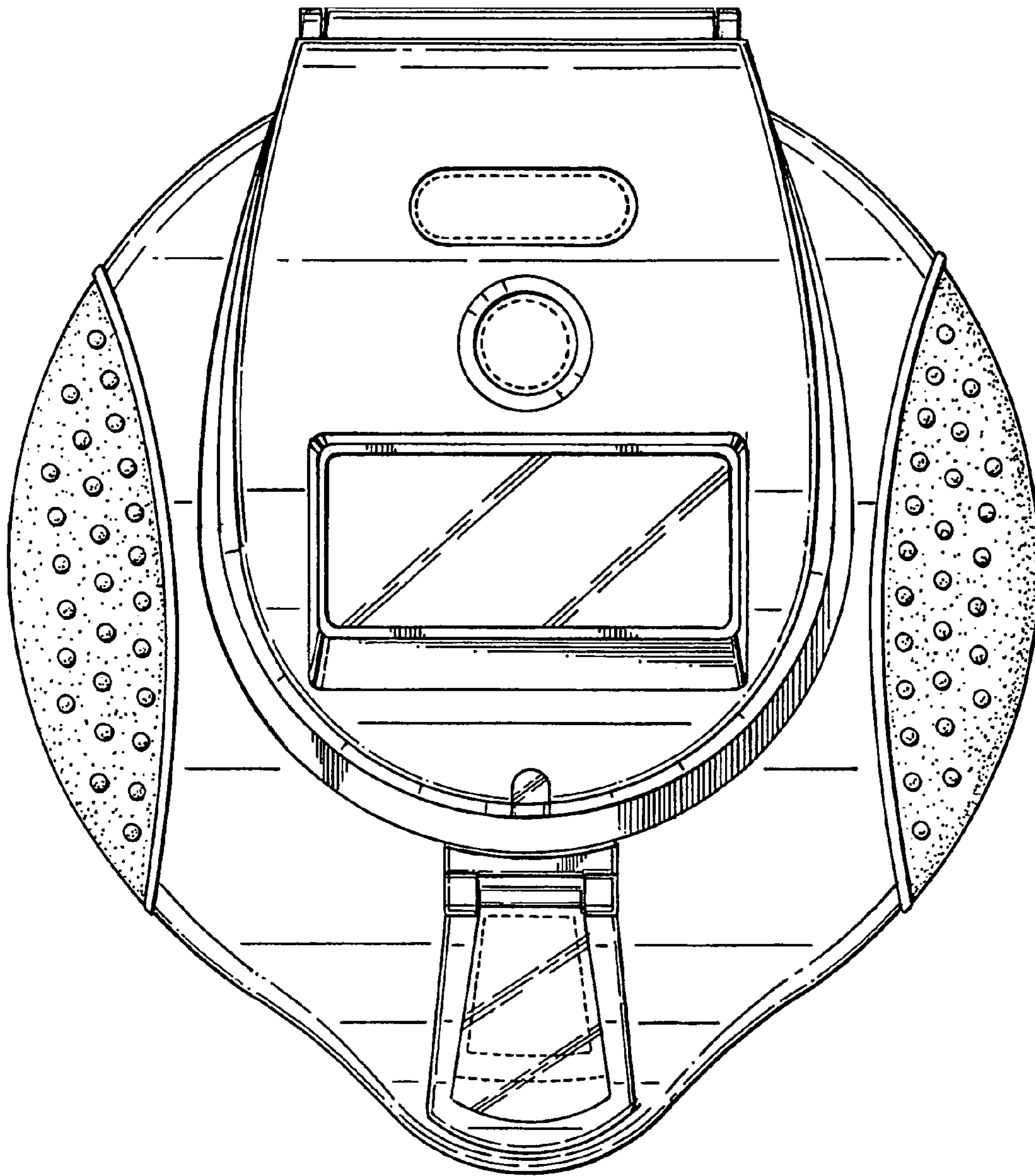
\* cited by examiner

**1 Claim, 5 Drawing Sheets**

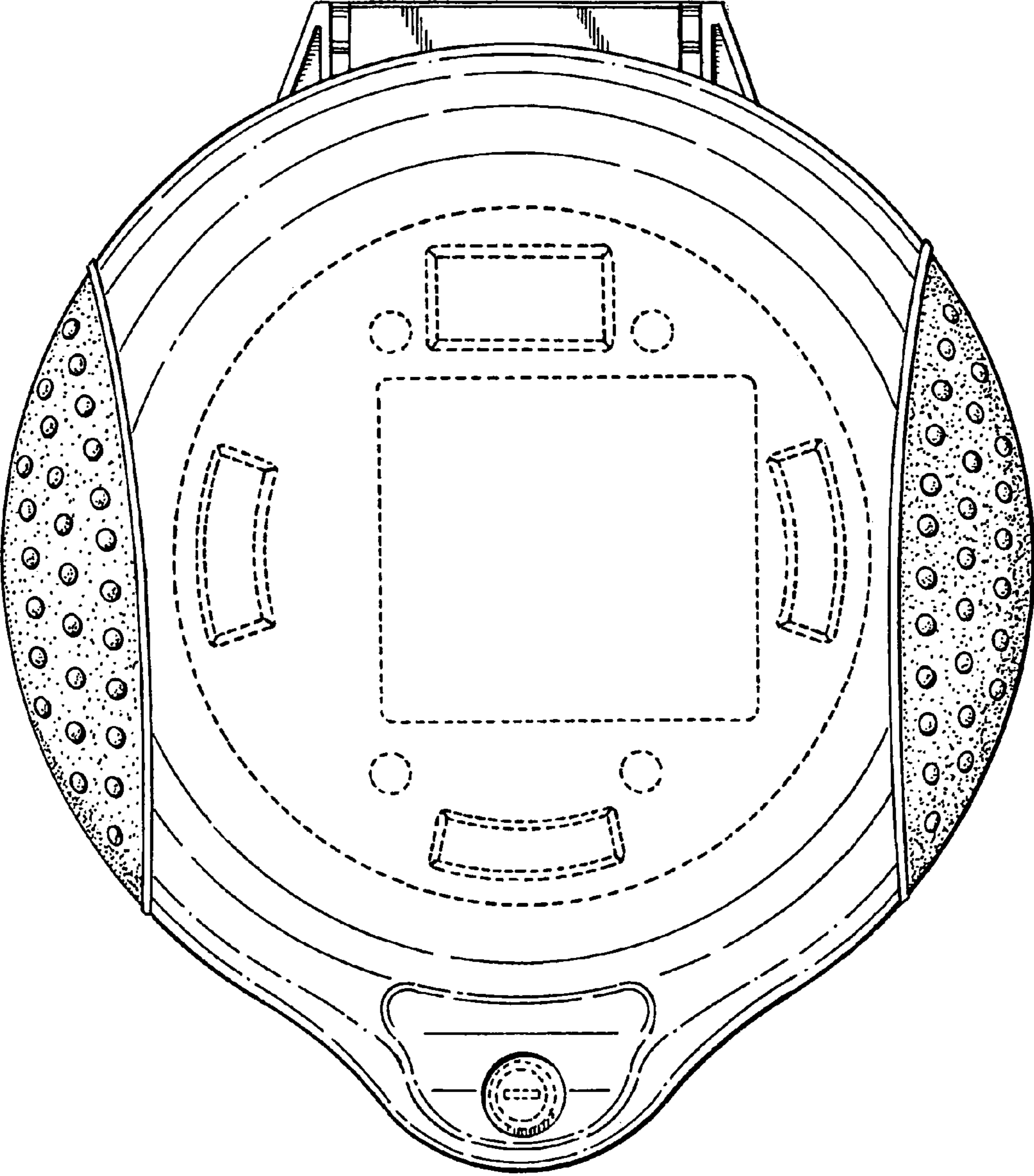




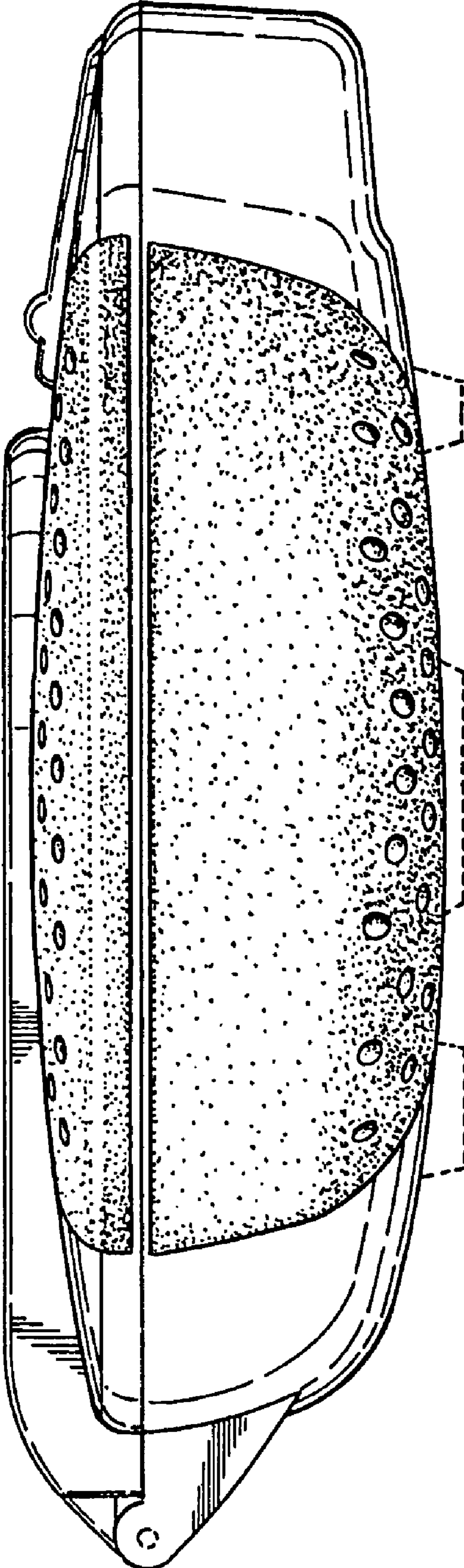
**Fig. 1**



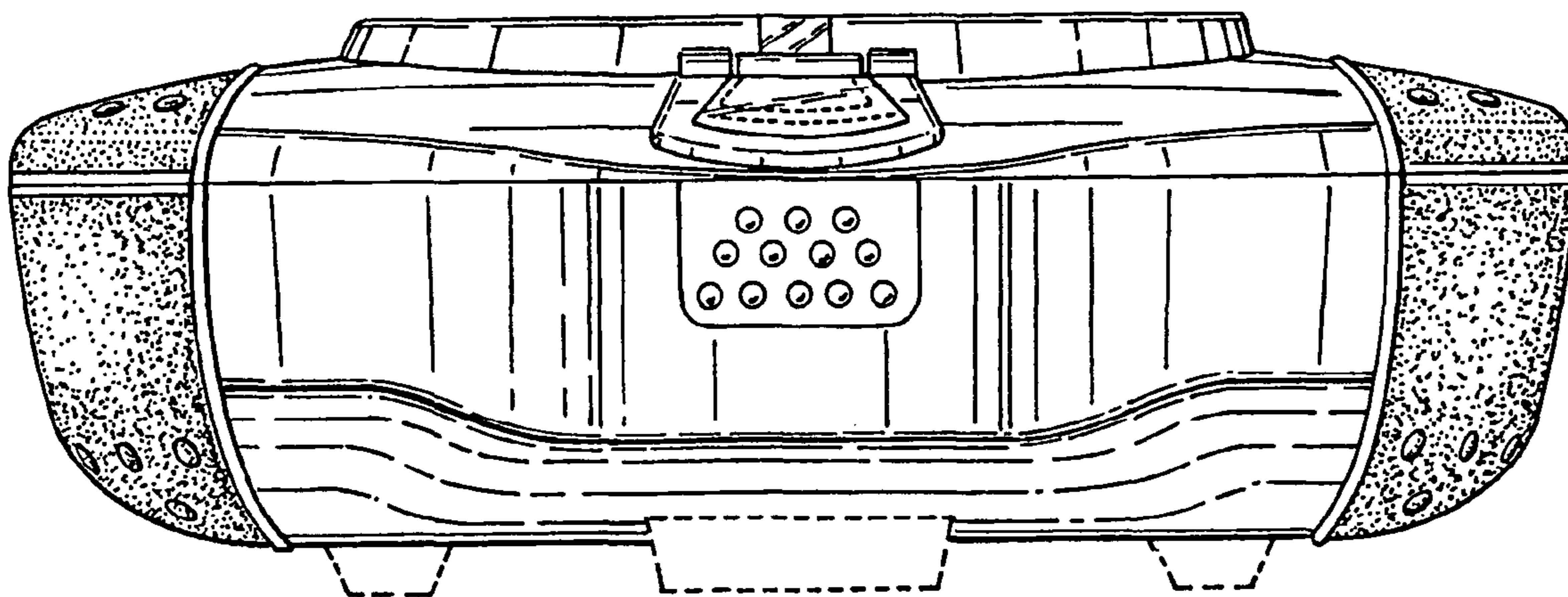
**Fig. 2**



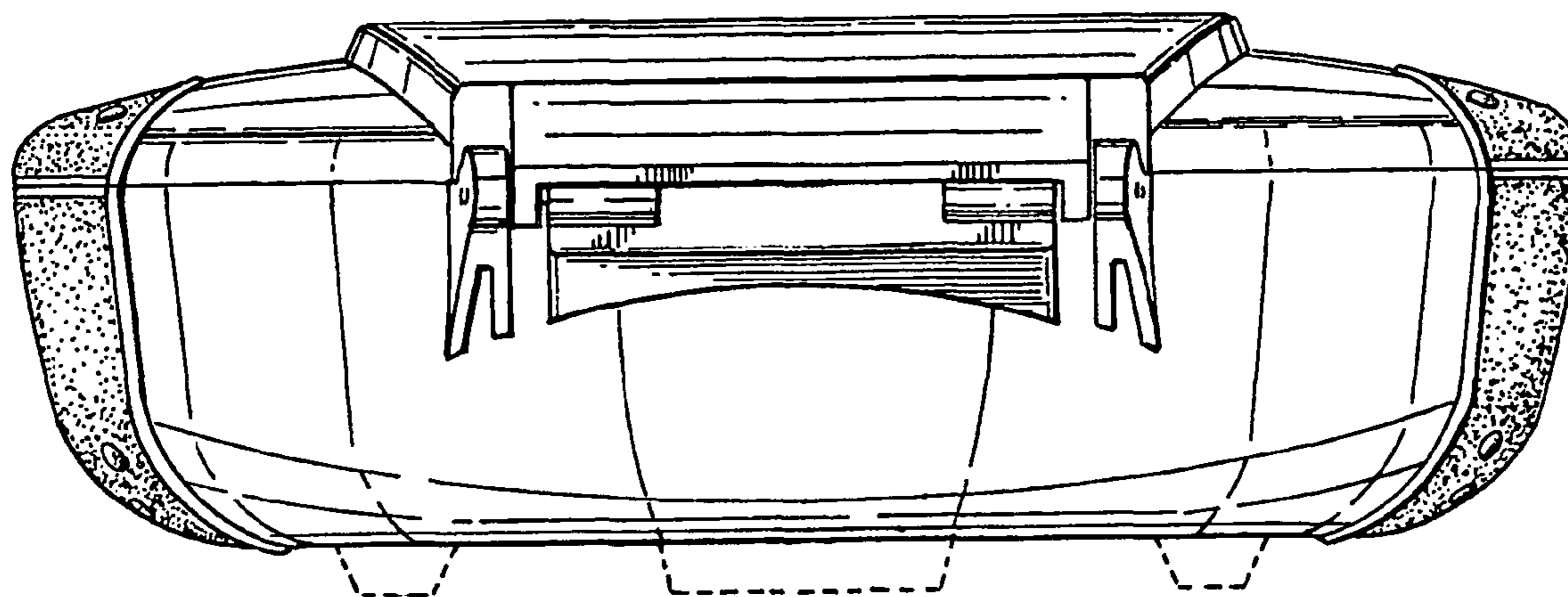
**Fig. 3**



**Fig. 4**



**Fig. 5**



**Fig. 6**