



US00D610789S

(12) **United States Design Patent**
Ng

(10) **Patent No.:** **US D610,789 S**
(45) **Date of Patent:** **** Mar. 2, 2010**

(54) **FOOTWEAR UPPER**

- (75) Inventor: **Natalie Ng**, Santa Barbara, CA (US)
- (73) Assignee: **Deckers Outdoor Corporation**, Goleta, CA (US)
- (**) Term: **14 Years**
- (21) Appl. No.: **29/342,884**
- (22) Filed: **Sep. 2, 2009**
- (51) **LOC (9) Cl.** **02-99**
- (52) **U.S. Cl.** **D2/970; D2/910**
- (58) **Field of Classification Search** D2/896,
D2/900, 902, 909-913, 946, 969, 970, 972-974;
36/45, 50.1, 77 M, 77 R, 83, 88, 113, 114,
36/126-181

See application file for complete search history.

(56) **References Cited**

U.S. PATENT DOCUMENTS

D46,548 S	10/1914	Saunders	
1,978,140 A	10/1934	Miller	
D238,909 S *	2/1976	Gustav D2/911
D370,114 S	5/1996	Vance et al.	
D410,322 S *	6/1999	Davidowitz et al. D2/910
D500,583 S *	1/2005	Belley et al. D2/970
D538,014 S *	3/2007	Choi D2/910
D579,646 S *	11/2008	Andersen et al. D2/970
D584,039 S *	1/2009	Horne et al. D2/970
D584,499 S	1/2009	Ringholz	

* cited by examiner

Primary Examiner—Robert M Spear
Assistant Examiner—Rashida C McCoy
(74) *Attorney, Agent, or Firm*—Greer, Burns & Crain, Ltd.

(57) **CLAIM**

The ornamental design for a footwear upper, as shown and described.

DESCRIPTION

FIG. 1 is a perspective view of a footwear upper showing my new design in a first position;
 FIG. 2 is a side elevational view thereof;
 FIG. 3 is an opposite side elevational view thereof;
 FIG. 4 is a front elevational view thereof;
 FIG. 5 is a rear elevational view thereof;
 FIG. 6 is a top plan view thereof; and
 FIG. 7 is a bottom plan view thereof.
 FIG. 8 is a perspective view of a footwear upper showing my new design in an alternate position;
 FIG. 9 is a side elevational view thereof in the alternate position;
 FIG. 10 is an opposite side elevational view thereof in the alternate position;
 FIG. 11 is a front elevational view thereof in the alternate position;
 FIG. 12 is a rear elevational view thereof in the alternate position;
 FIG. 13 is a top plan view thereof in the alternate position; and,
 FIG. 14 is a bottom plan view thereof in the alternate position.
 The broken lines in FIGS. 1-14 represent portions of the footwear that form no part of the claimed design. The broken line in FIGS. 6 and 13 define the bounds of the claimed design and forms no part thereof.

1 Claim, 10 Drawing Sheets

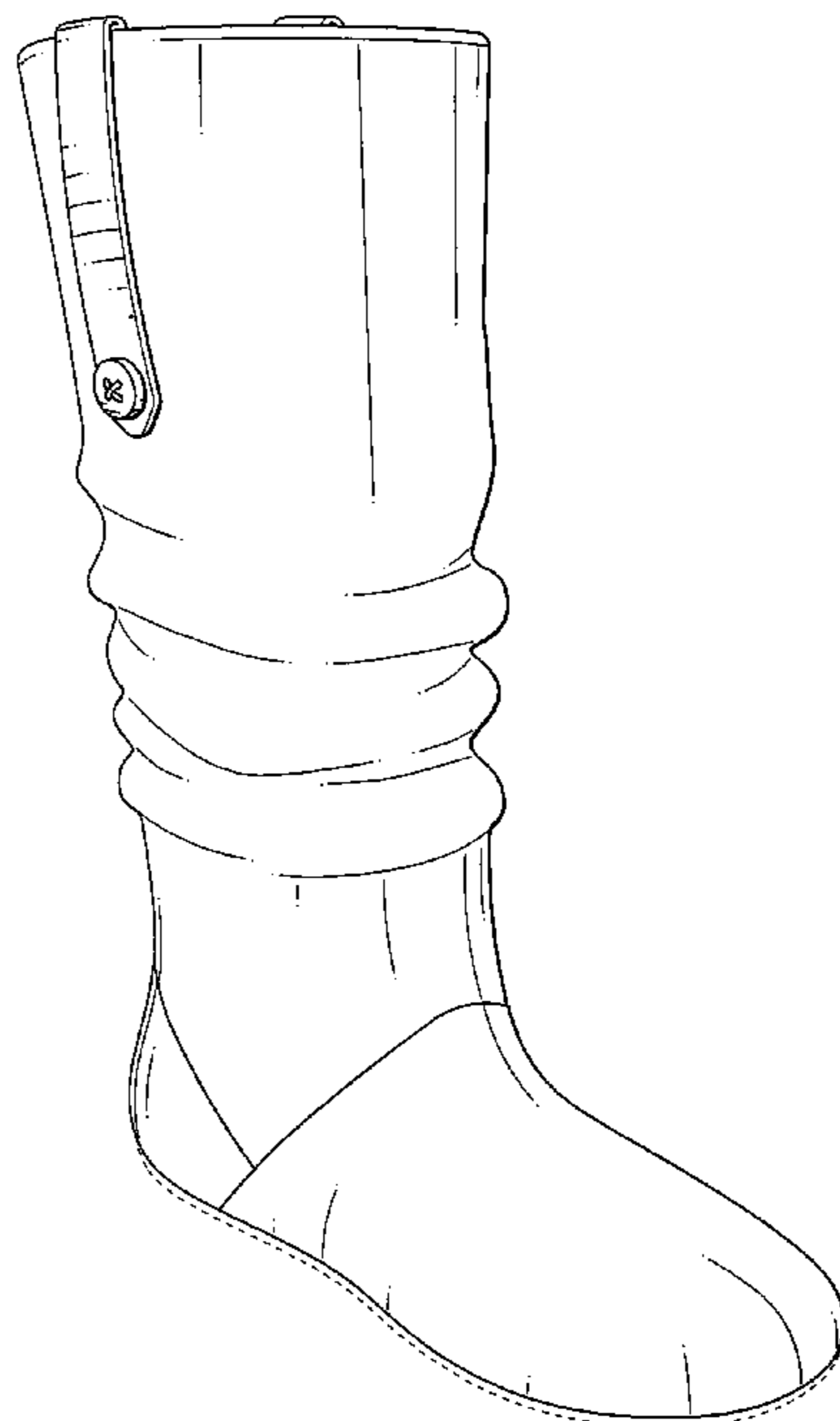

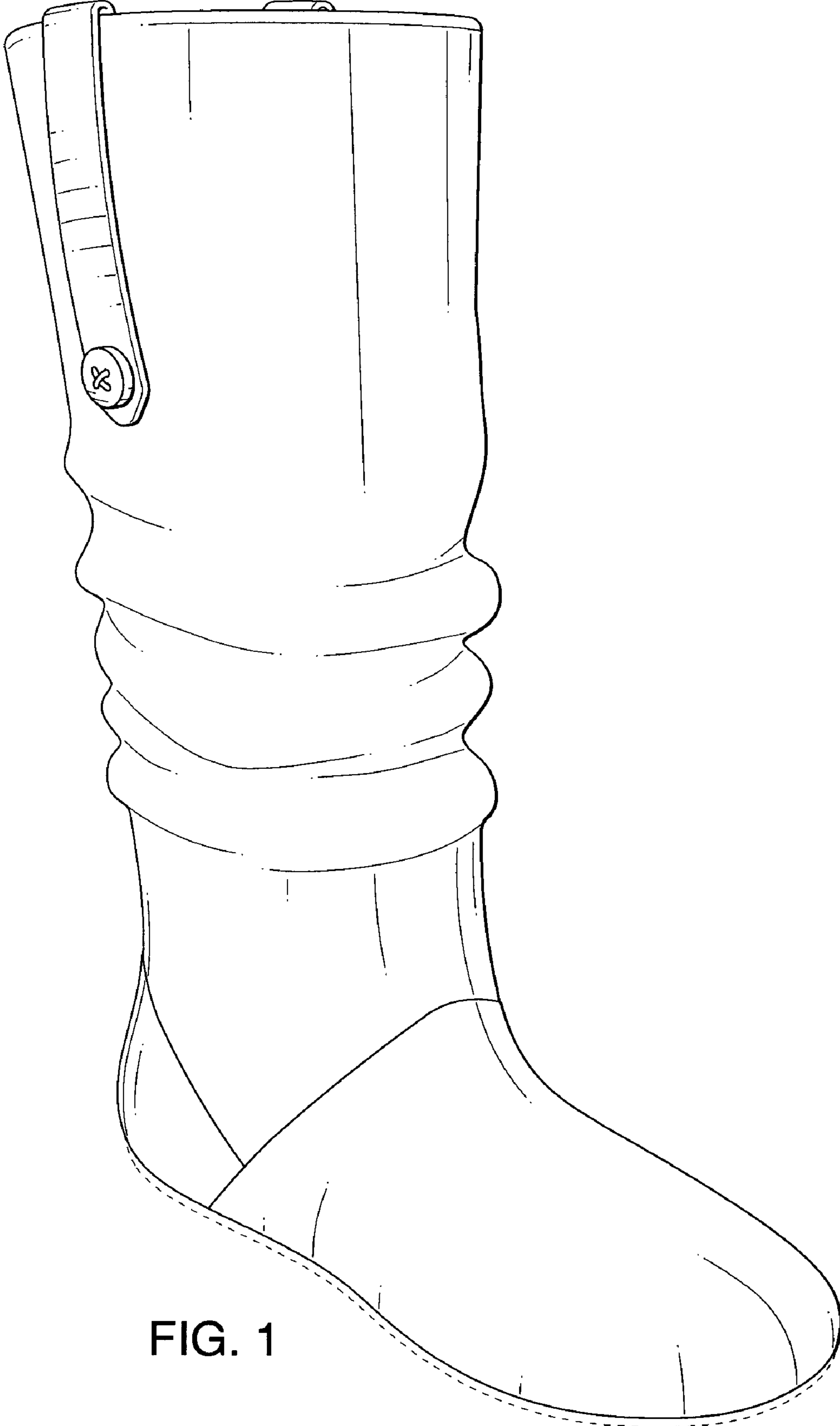

FIG. 1

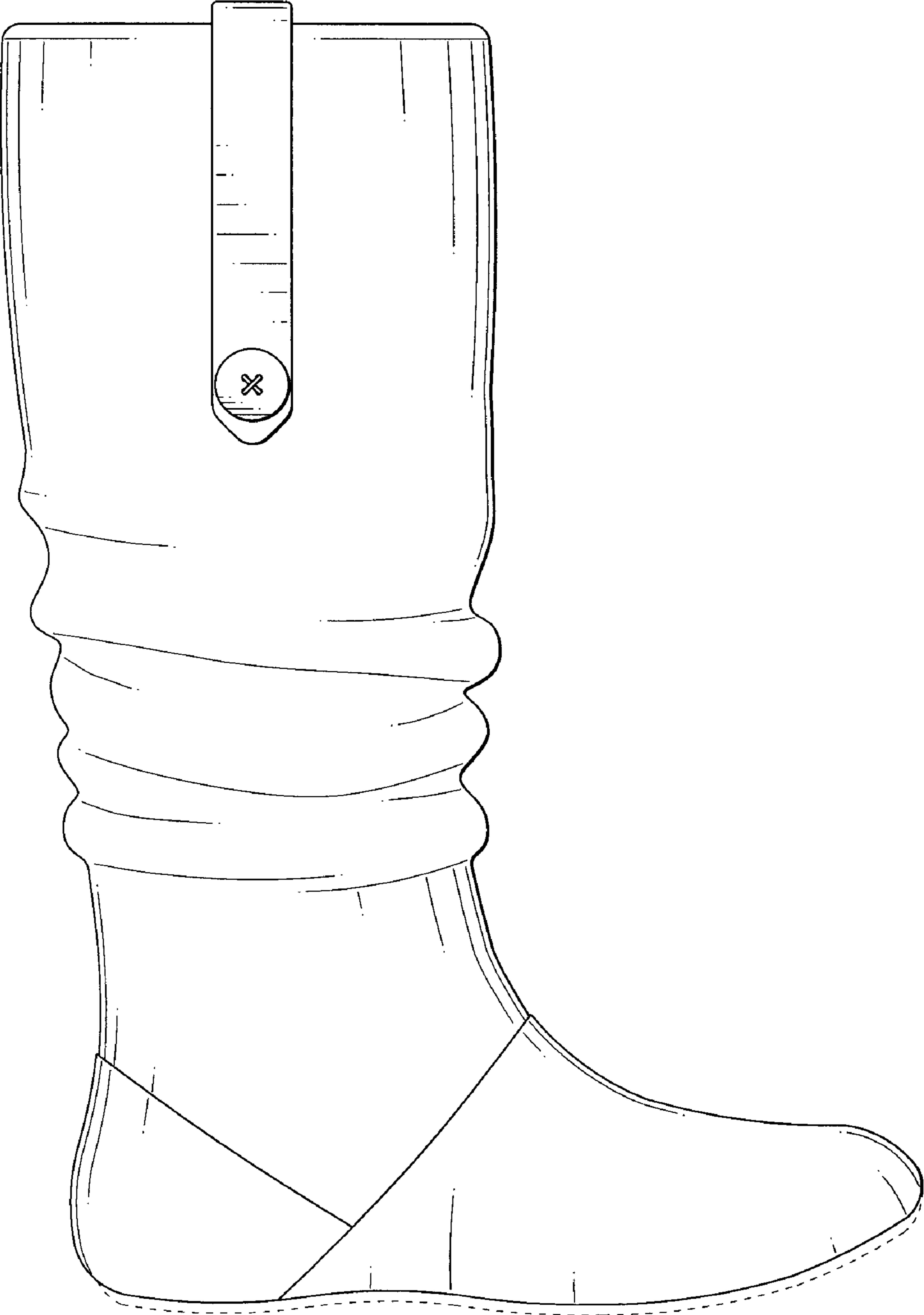

FIG. 2

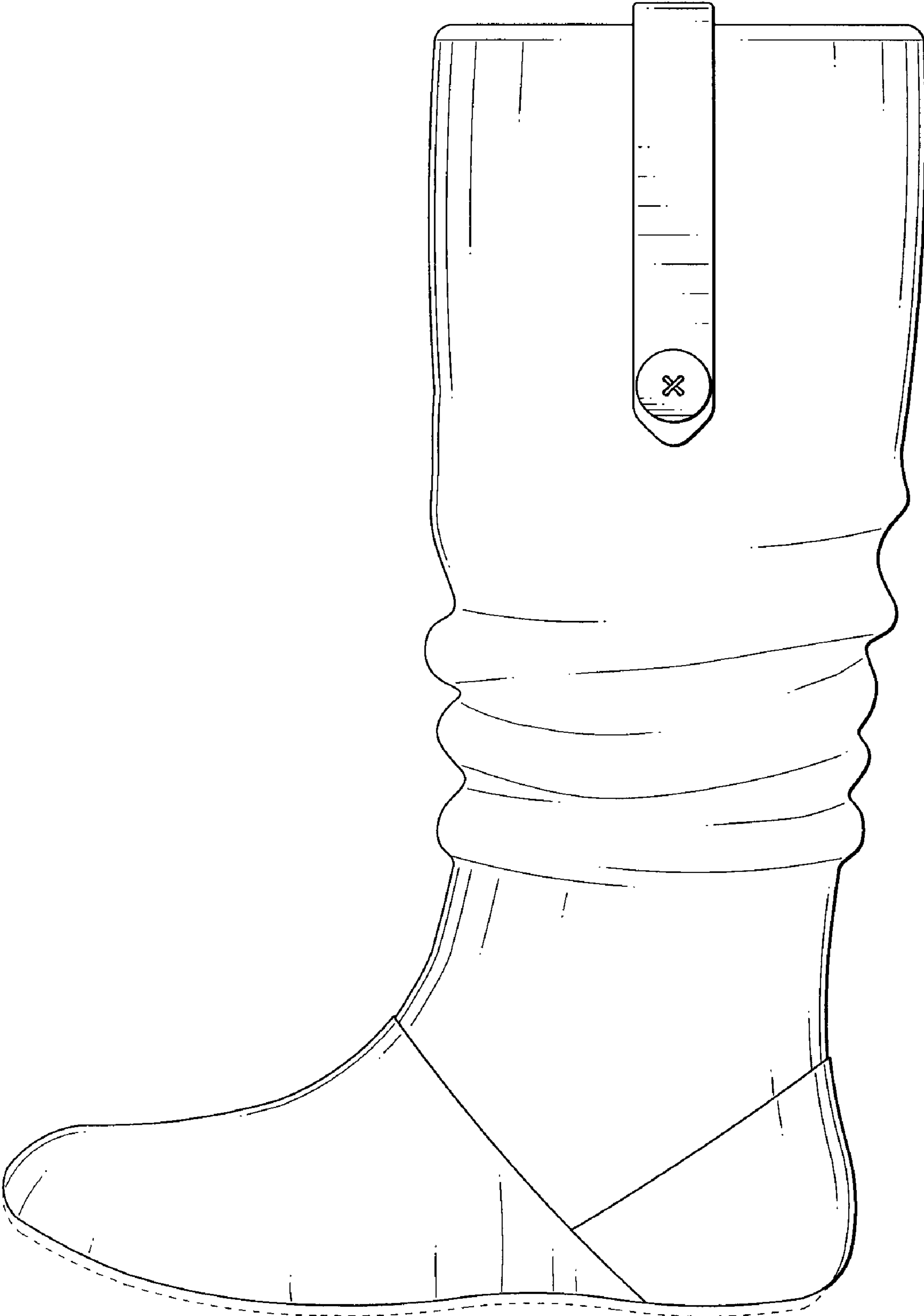

FIG. 3

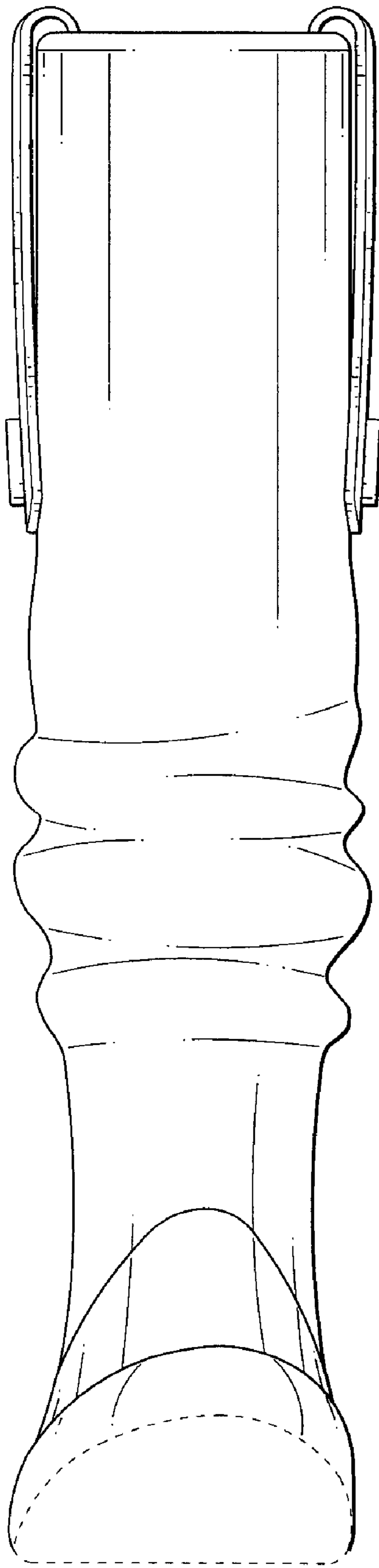

FIG. 4

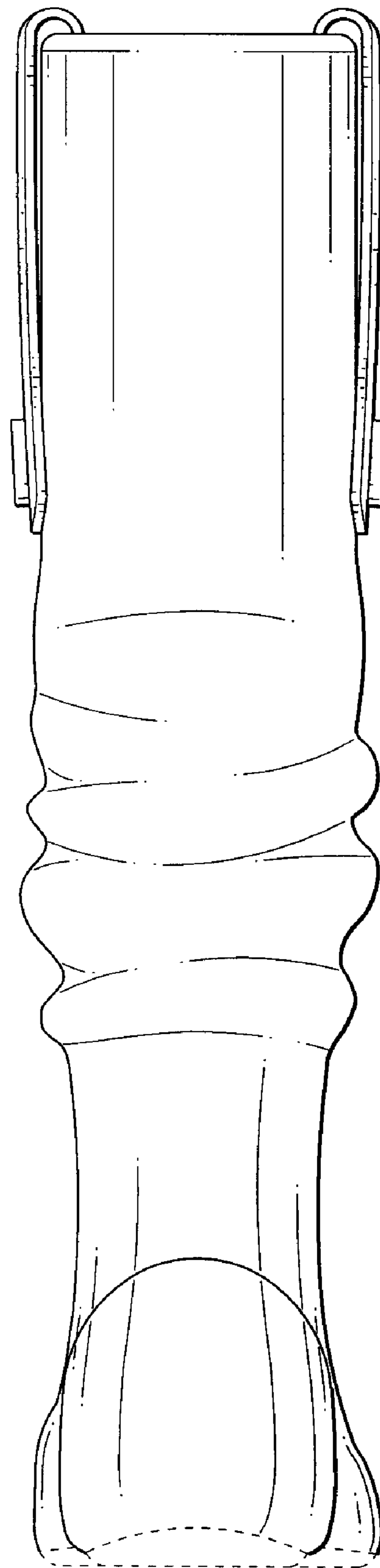

FIG. 5

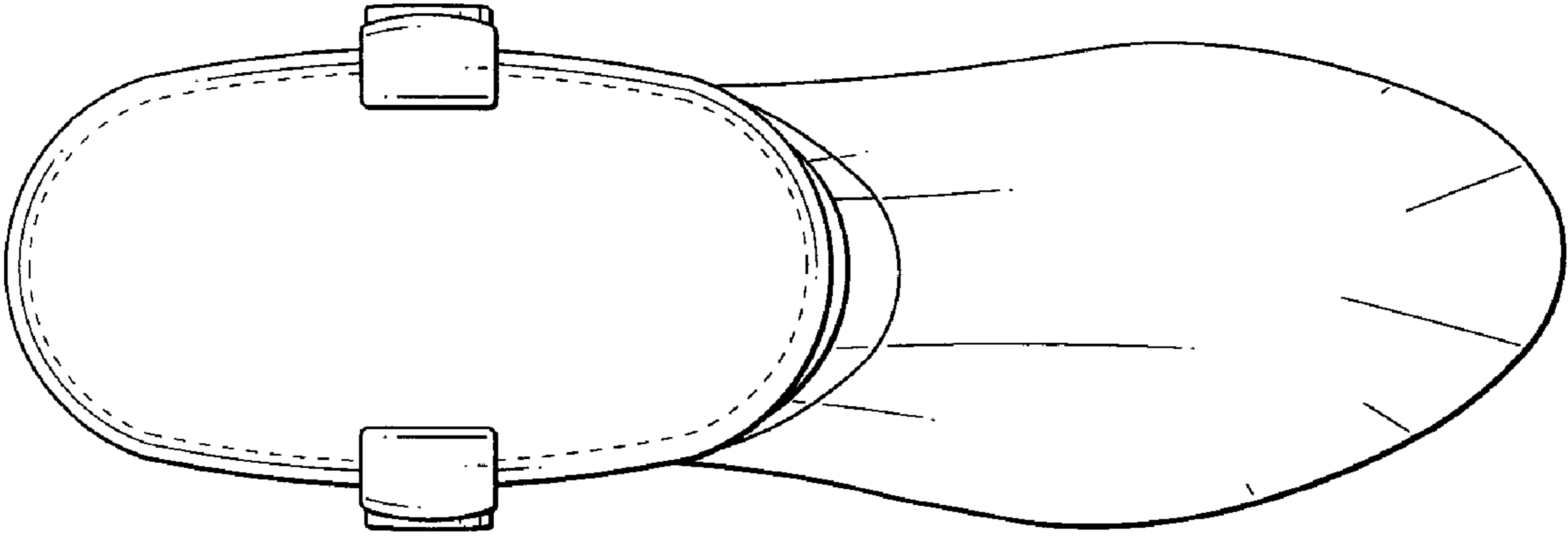

FIG. 6

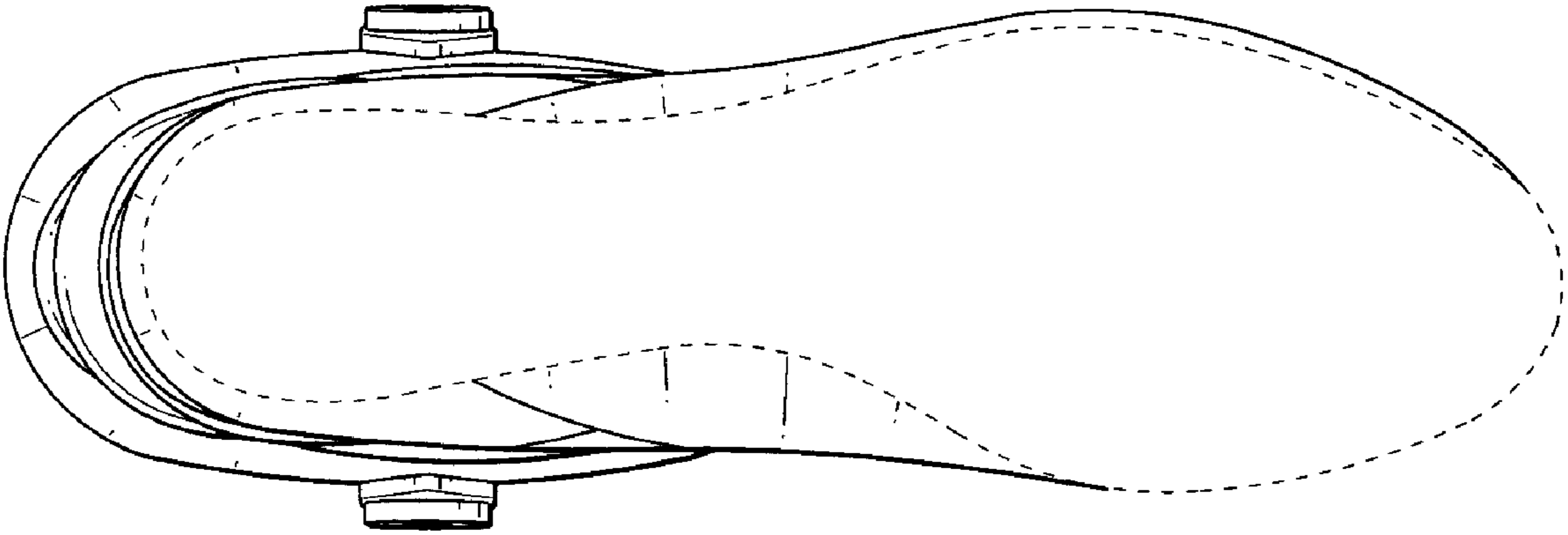

FIG. 7

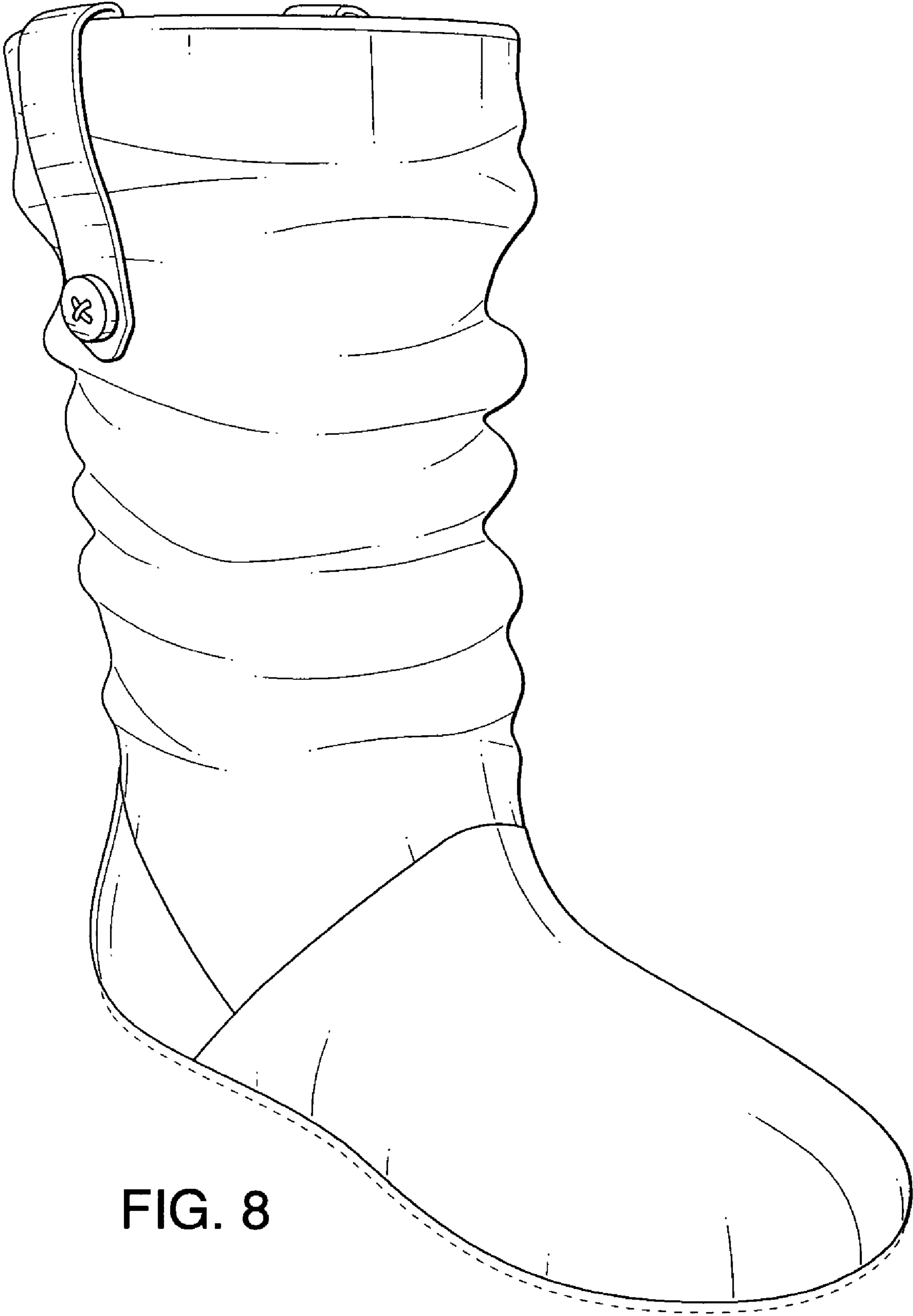

FIG. 8

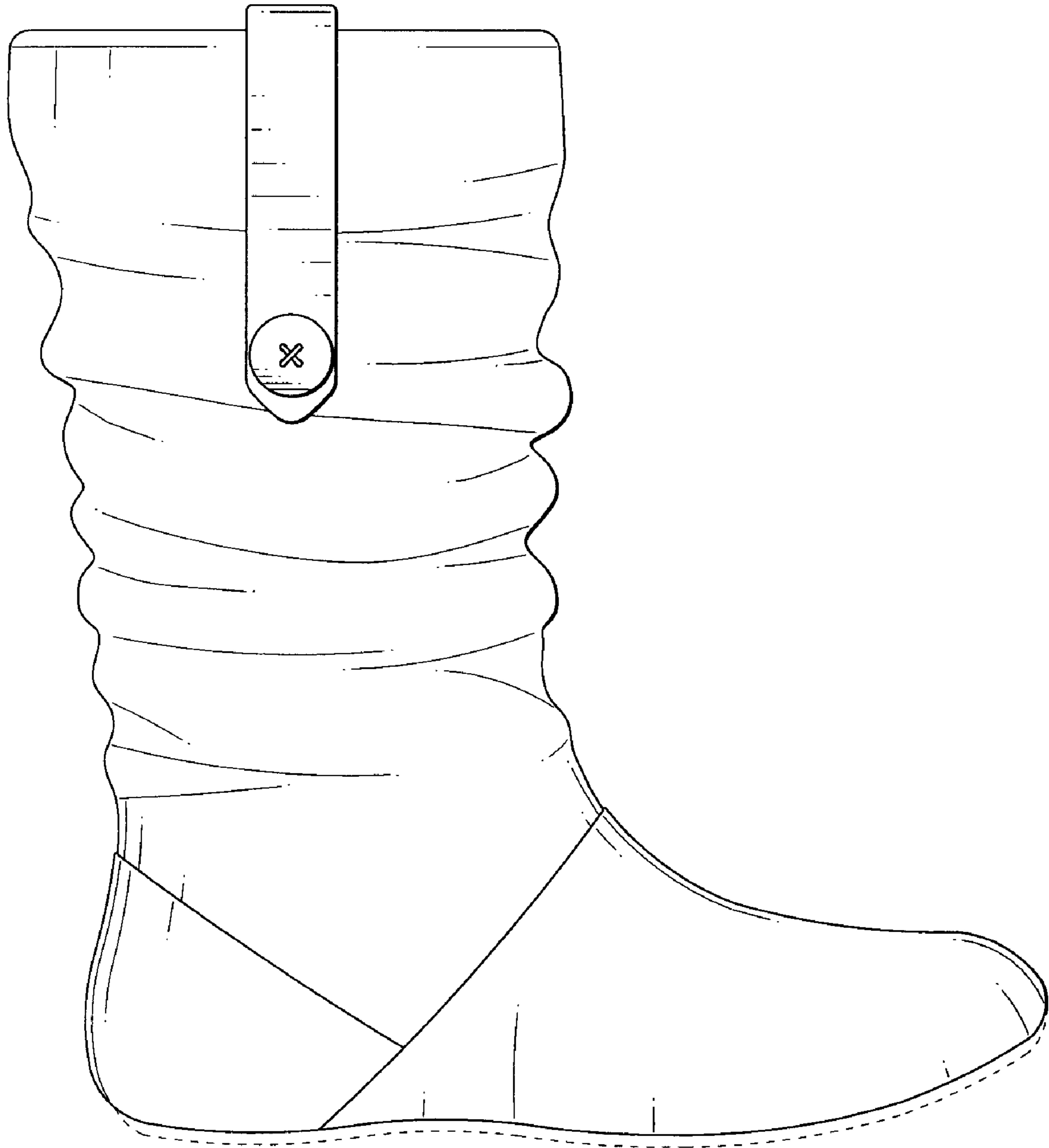

FIG. 9

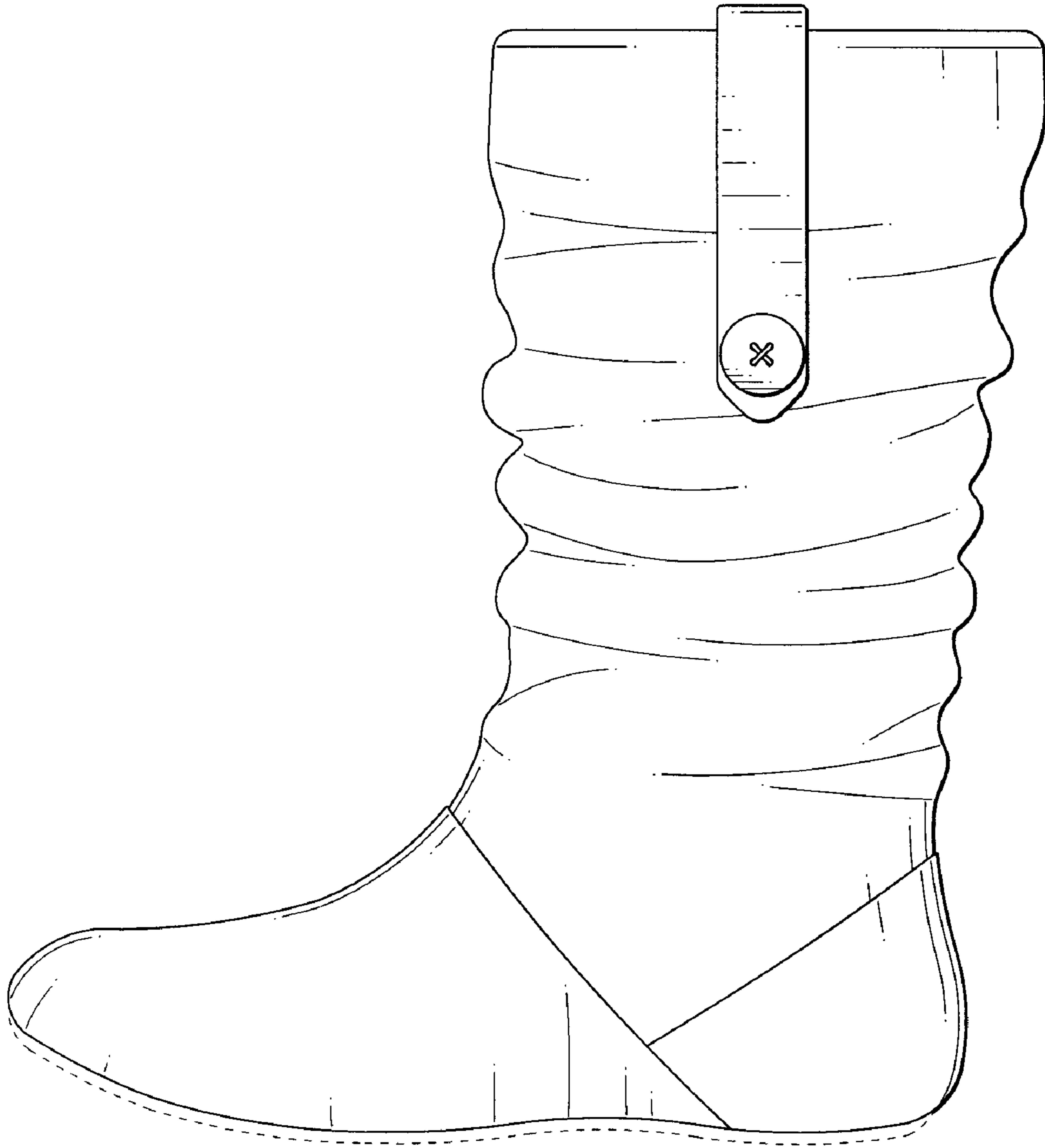

FIG. 10

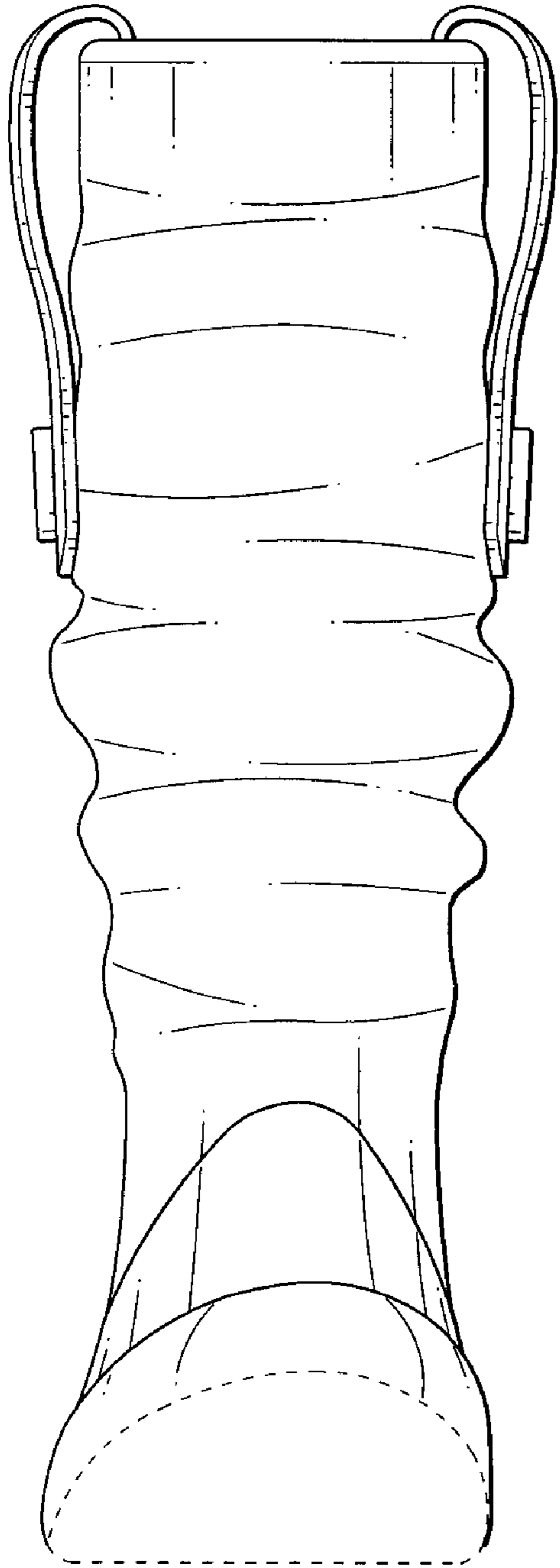

FIG. 11

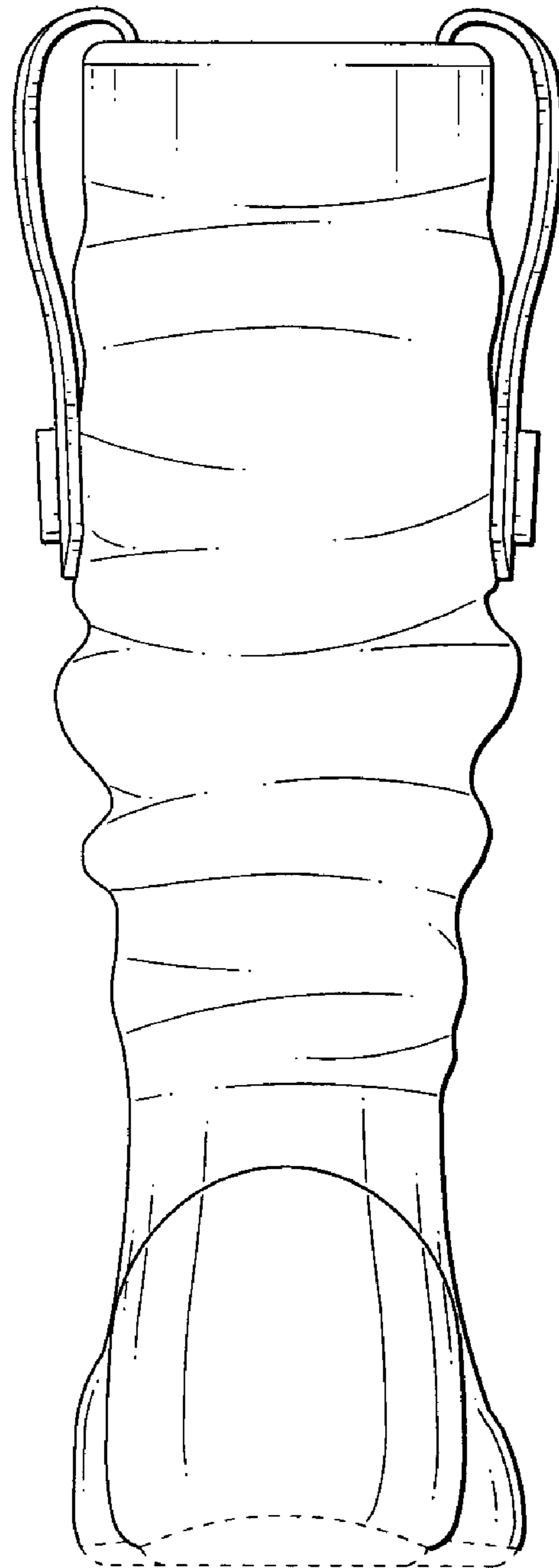

FIG. 12

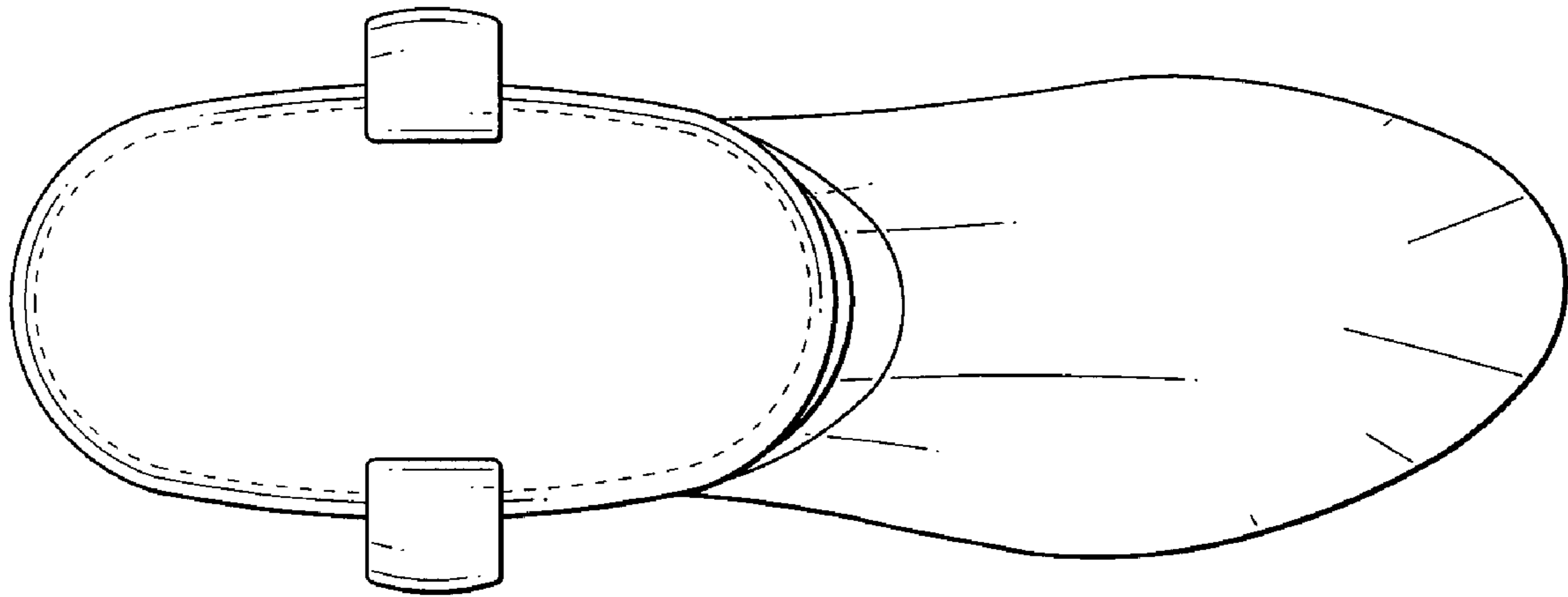

FIG. 13

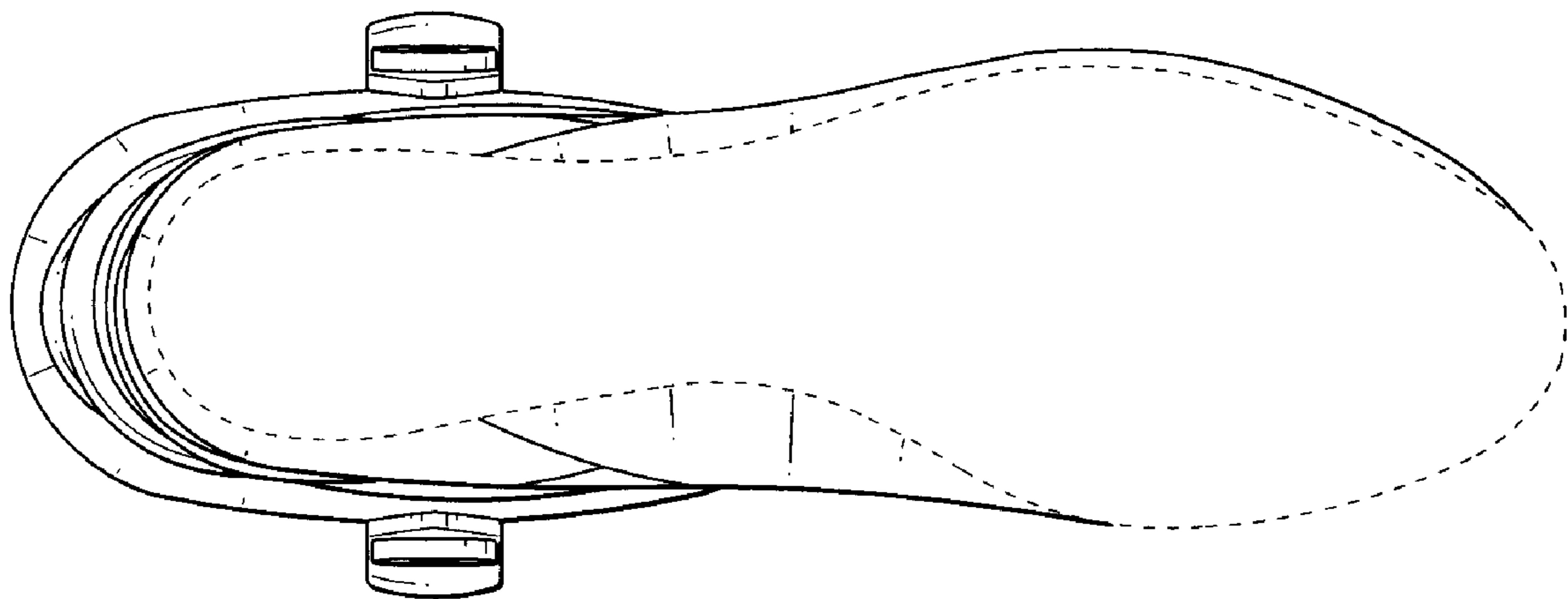

FIG. 14