



US00D610745S

(12) **United States Design Patent**
Keong

(10) **Patent No.:** **US D610,745 S**

(45) **Date of Patent:** **** Feb. 23, 2010**

(54) **HAIR DRYER**

(75) Inventor: **Wai Ho Michael Keong**, New Territories (HK)

(73) Assignee: **Kenford Industrial Co. Ltd.**, New Territories (HK)

(**) Term: **14 Years**

(21) Appl. No.: **29/331,191**

(22) Filed: **Jan. 21, 2009**

(30) **Foreign Application Priority Data**

Jul. 24, 2008 (CN) 2008 3 0211329

(51) **LOC (9) Cl.** **28-03**

(52) **U.S. Cl.** **D28/13**

(58) **Field of Classification Search** D28/12-19;
34/96-101; 392/380-385; 219/222

See application file for complete search history.

(56) **References Cited**

U.S. PATENT DOCUMENTS

- D254,833 S * 4/1980 Cooper D32/18
- D425,243 S * 5/2000 Mattis D28/13
- D429,028 S * 8/2000 Muller et al. D28/13
- D433,181 S * 10/2000 Chu D28/13
- D436,227 S * 1/2001 Smal et al. D28/13

- D468,862 S * 1/2003 Barski D28/13
- D525,389 S * 7/2006 Yu D28/13
- D541,982 S * 5/2007 Choi D28/13
- D580,594 S * 11/2008 Leung D28/13

* cited by examiner

Primary Examiner—Janice E Seeger

Assistant Examiner—Zenia I Bennett

(74) *Attorney, Agent, or Firm*—Intellectual Property Law Group LLP; Juneko Jackson; Otto O. Lee

(57) **CLAIM**

The ornamental design for a hair dryer, as shown and described.

DESCRIPTION

FIG. 1 is a perspective view of a hair dryer, embodying my new design;

FIG. 2 is a left side elevational view thereof;

FIG. 3 is a right side elevational view thereof;

FIG. 4 is a front elevational view thereof; the rear elevational view being a mirror image thereof;

FIG. 5 is a top plan view thereof; and,

FIG. 6 is a bottom plan view thereof.

The broken lines are for environmental purposes only and form no part of the claimed design.

1 Claim, 2 Drawing Sheets

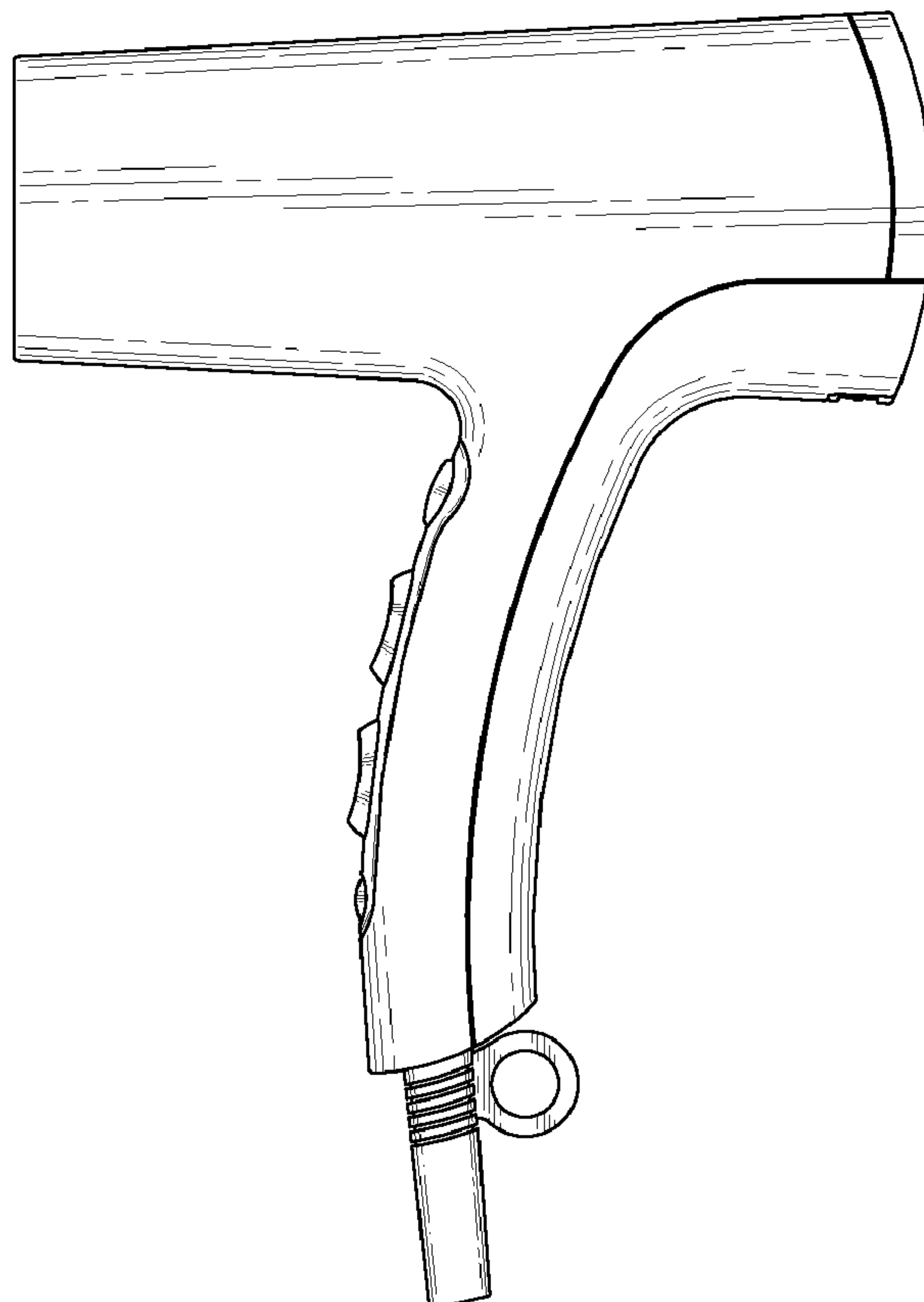

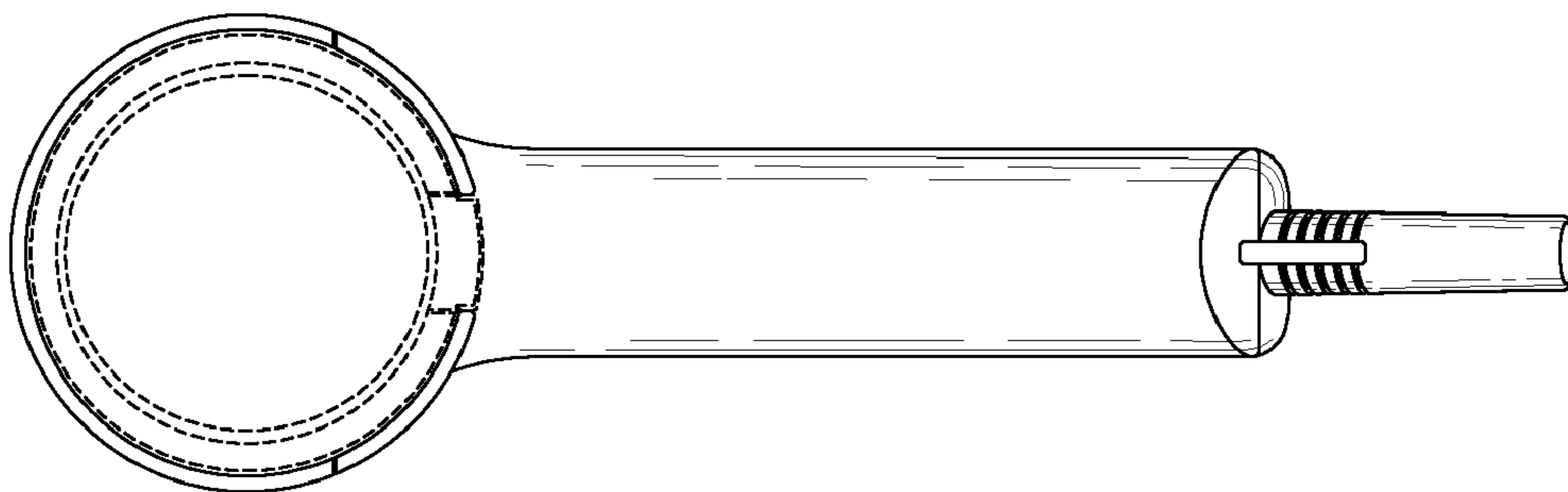

FIG. 3

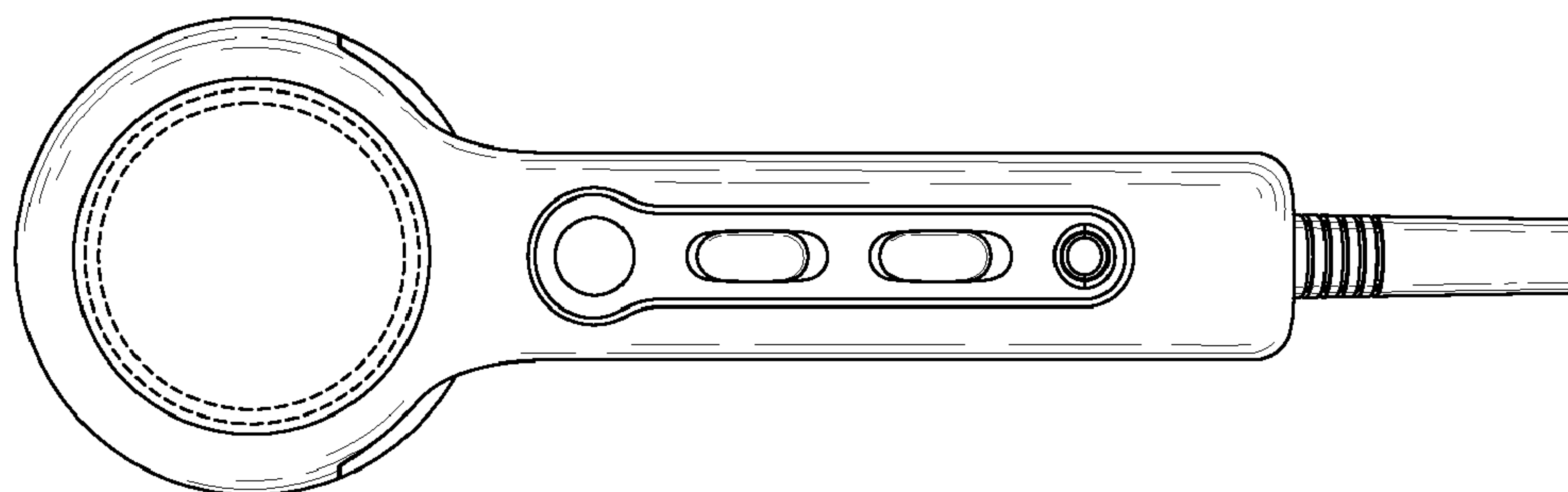

FIG. 2

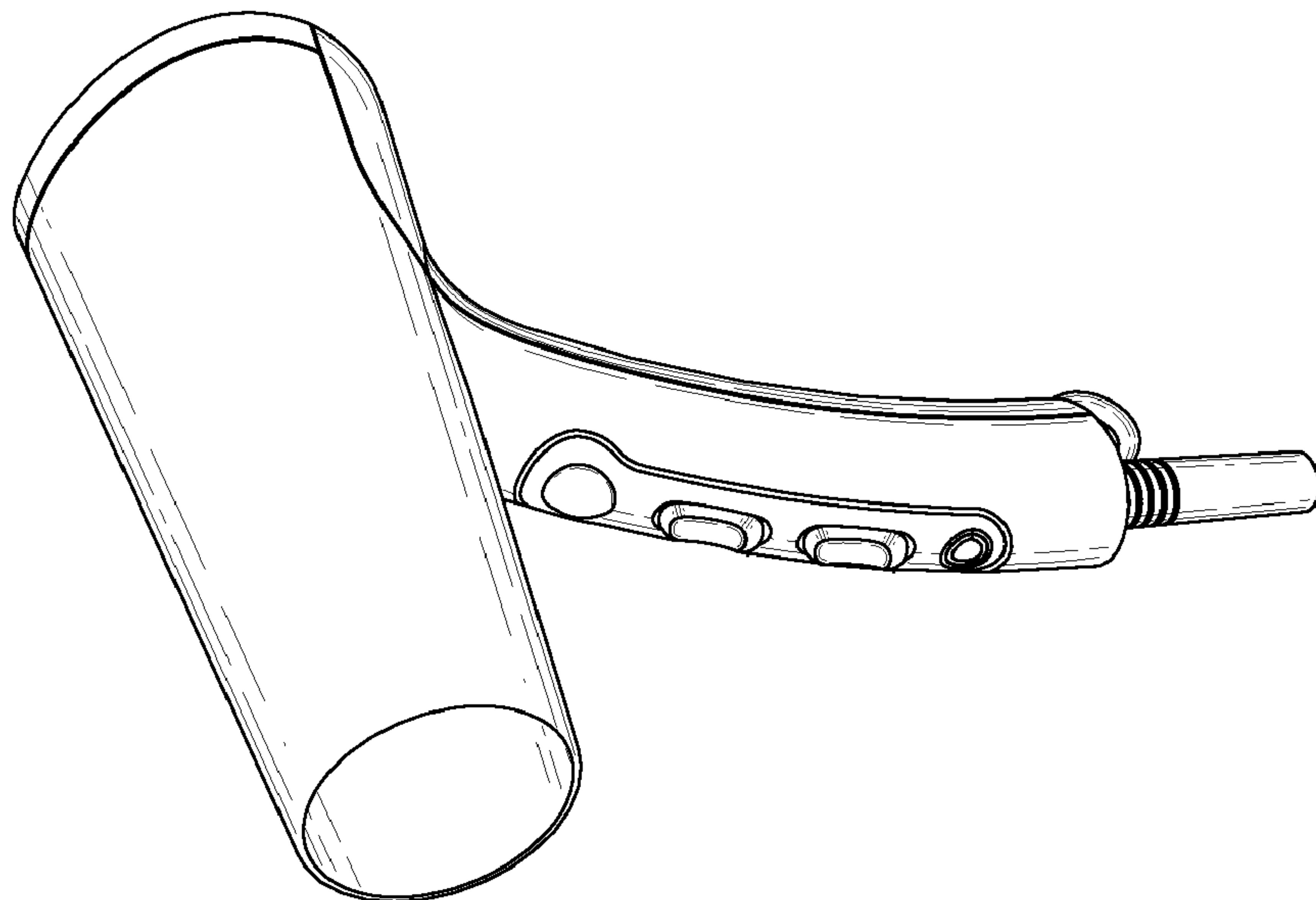

FIG. 1

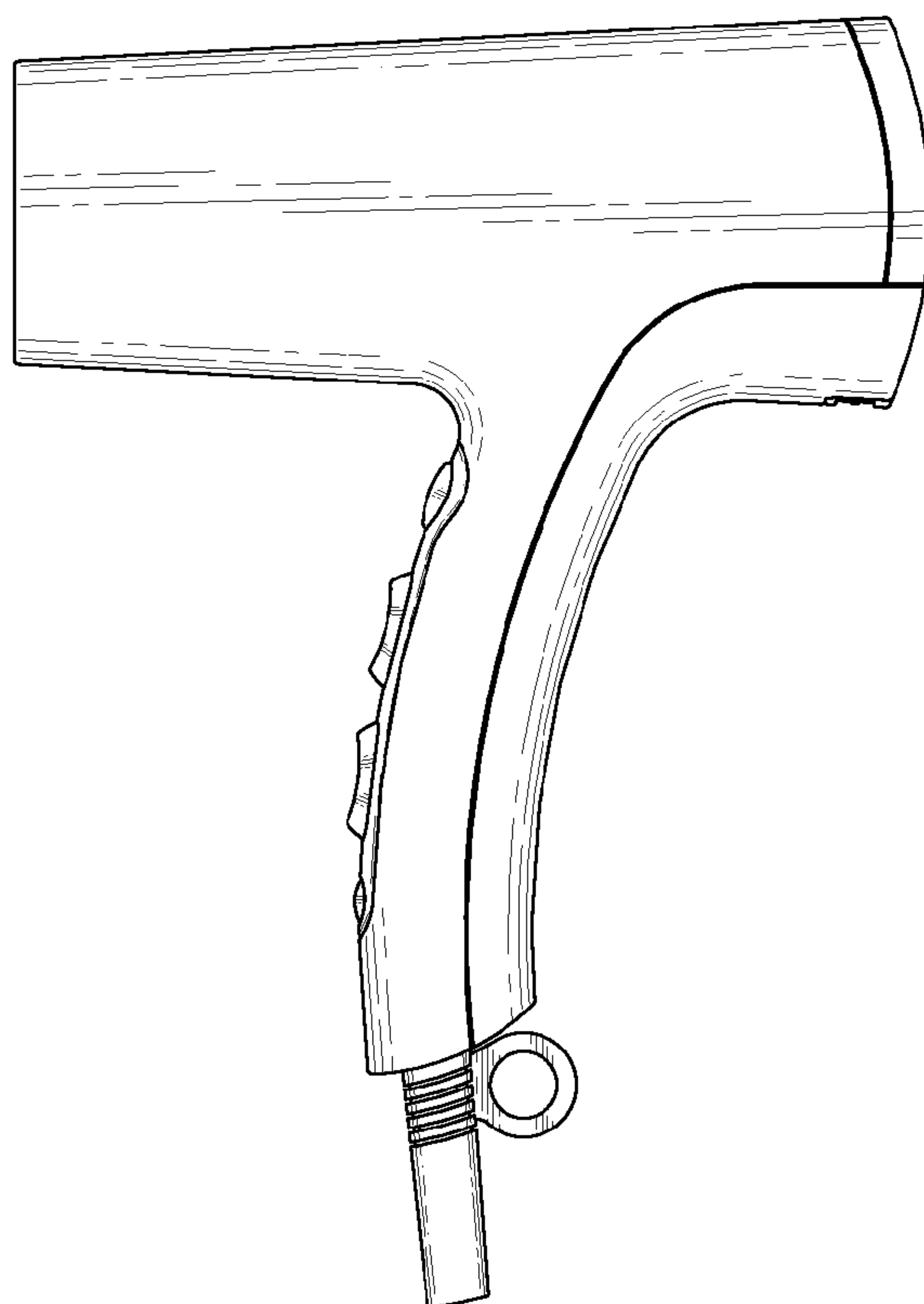

FIG. 4

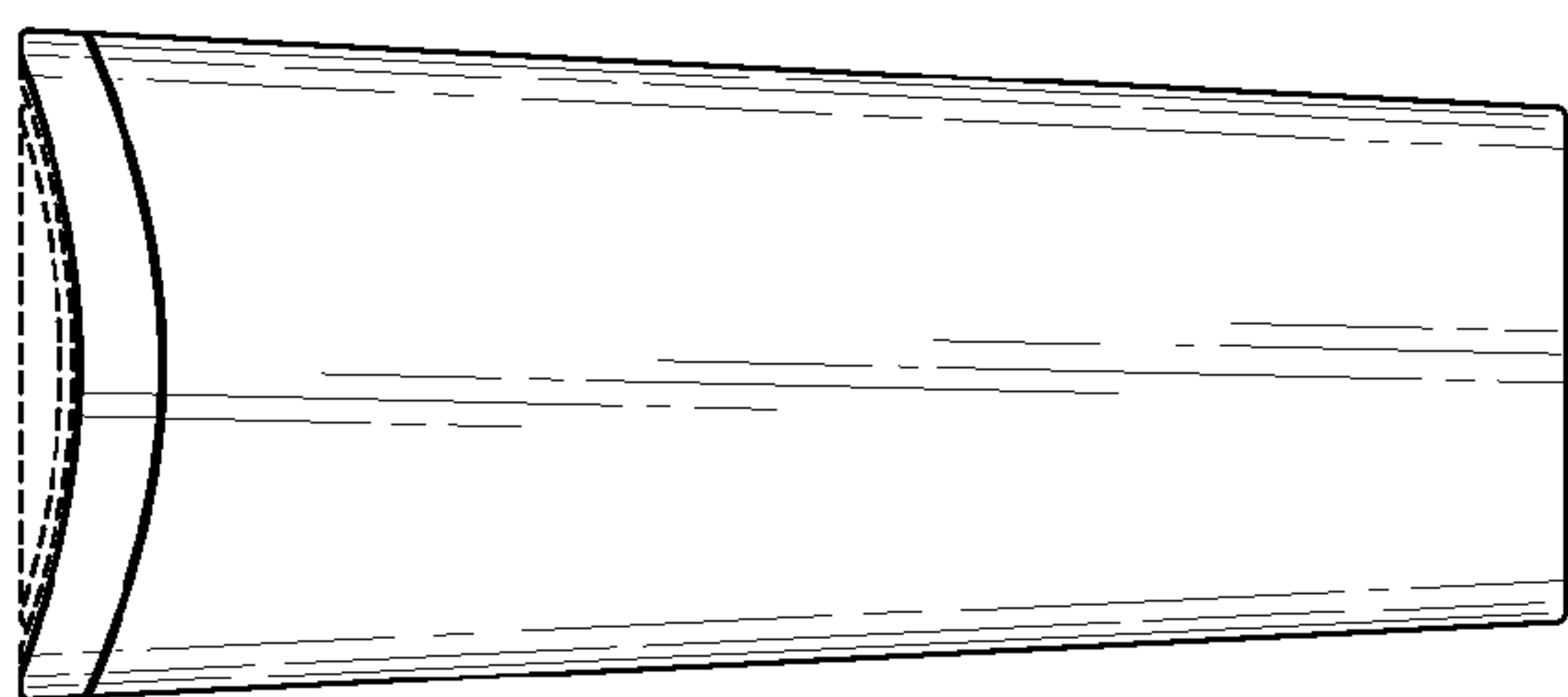

FIG. 5

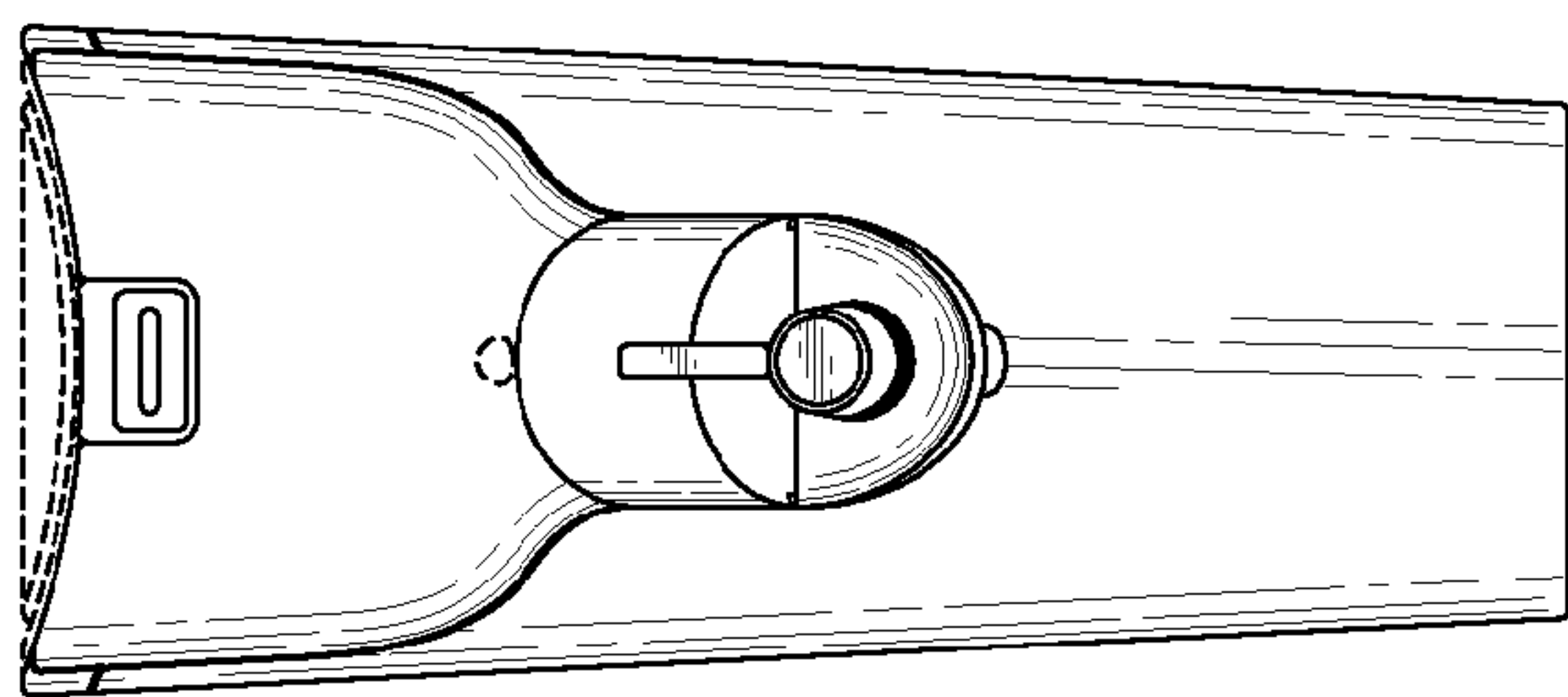

FIG. 6