



US00D610666S

(12) **United States Design Patent**  
**Furner et al.**

(10) **Patent No.:** **US D610,666 S**  
(45) **Date of Patent:** **\*\* Feb. 23, 2010**

(54) **VOLATILE DISPENSER**

(57) **CLAIM**

(75) Inventors: **Paul E. Furner**, Racine, WI (US); **Anne Kitzmiller**, San Francisco, CA (US); **Christopher Kuh**, Dusseldorf (DE)

The ornamental design for a volatile dispenser, as shown and described.

(73) Assignee: **S.C. Johnson & Son, Inc.**, Racine, WI (US)

**DESCRIPTION**

(\*\*) Term: **14 Years**

(21) Appl. No.: **29/340,483**

(22) Filed: **Jul. 20, 2009**

(51) **LOC (9) Cl.** ..... **28-99**

(52) **U.S. Cl.** ..... **D23/366**

(58) **Field of Classification Search** ..... D23/355-369;  
D28/5, 6; 261/DIG. 17, DIG. 42, DIG. 65,  
261/DIG. 88, DIG. 89; 392/386, 390, 391,  
392/392, 394, 395, 389, 393; 239/34, 35,  
239/43-45, 53, 56, 57, 60, 326, 42, 50, 55

See application file for complete search history.

FIG. 1 is a left, top, frontal perspective view of a volatile dispenser embodying our new design;  
FIG. 2 is a front elevational view thereof;  
FIG. 3 is a left side elevational view thereof;  
FIG. 4 is a right side elevational view thereof;  
FIG. 5 is a rear elevational view thereof;  
FIG. 6 is a top plan view thereof;  
FIG. 7 is a bottom plan view thereof;  
FIG. 8 is a left, top, frontal perspective view of a second embodiment of our new design;  
FIG. 9 is a front elevational view thereof;  
FIG. 10 is a left side elevational view thereof;  
FIG. 11 is a right side elevational view thereof;  
FIG. 12 is a rear elevational view thereof;  
FIG. 13 is a top plan view thereof;  
FIG. 14 is a bottom plan view thereof;  
FIG. 15 is a left, top, frontal perspective view of a third embodiment of our new design;  
FIG. 16 is a front elevational view thereof;  
FIG. 17 is a left side elevational view thereof;  
FIG. 18 is a right side elevational view thereof;  
FIG. 19 is a rear elevational view thereof;  
FIG. 20 is a top plan view thereof; and,  
FIG. 21 is a bottom plan view thereof.

(56) **References Cited**

**U.S. PATENT DOCUMENTS**

D393,901 S	4/1998	Henrikus et al.	
5,899,382 A	5/1999	Hayes et al.	
6,371,450 B1	4/2002	Davis et al.	
D561,193 S	2/2006	Caserta et al.	
D532,506 S *	11/2006	Caserta et al.	D23/366
D544,953 S *	6/2007	Kee	D23/368
D546,431 S *	7/2007	Quinn et al.	D23/359
D551,750 S *	9/2007	Wefler	D23/366
D553,233 S	10/2007	Hatch et al.	
D565,164 S	3/2008	Duston et al.	

**FOREIGN PATENT DOCUMENTS**

EM	000142492-0001	6/2004
EM	000842778-0003	2/2008
EM	000842778-0004	2/2008

\* cited by examiner

The broken line representations of front vents in FIGS. 8-11, 13-18, and 20-21, side and bottom vents in FIGS. 8, 10-12, 15, 17-19, and 21, a raised section in FIGS. 8-11, 13, 15-18, and 20, an on/off switch in FIGS. 8, 9, 11-16, and 18-21, mating lines in FIGS. 8, 10-15, and 17-21, and a clip in FIGS. 15, and 17-21 are for purposes of illustration only and form no part of the claimed design.

Primary Examiner—Sandra Snapp

**1 Claim, 15 Drawing Sheets**

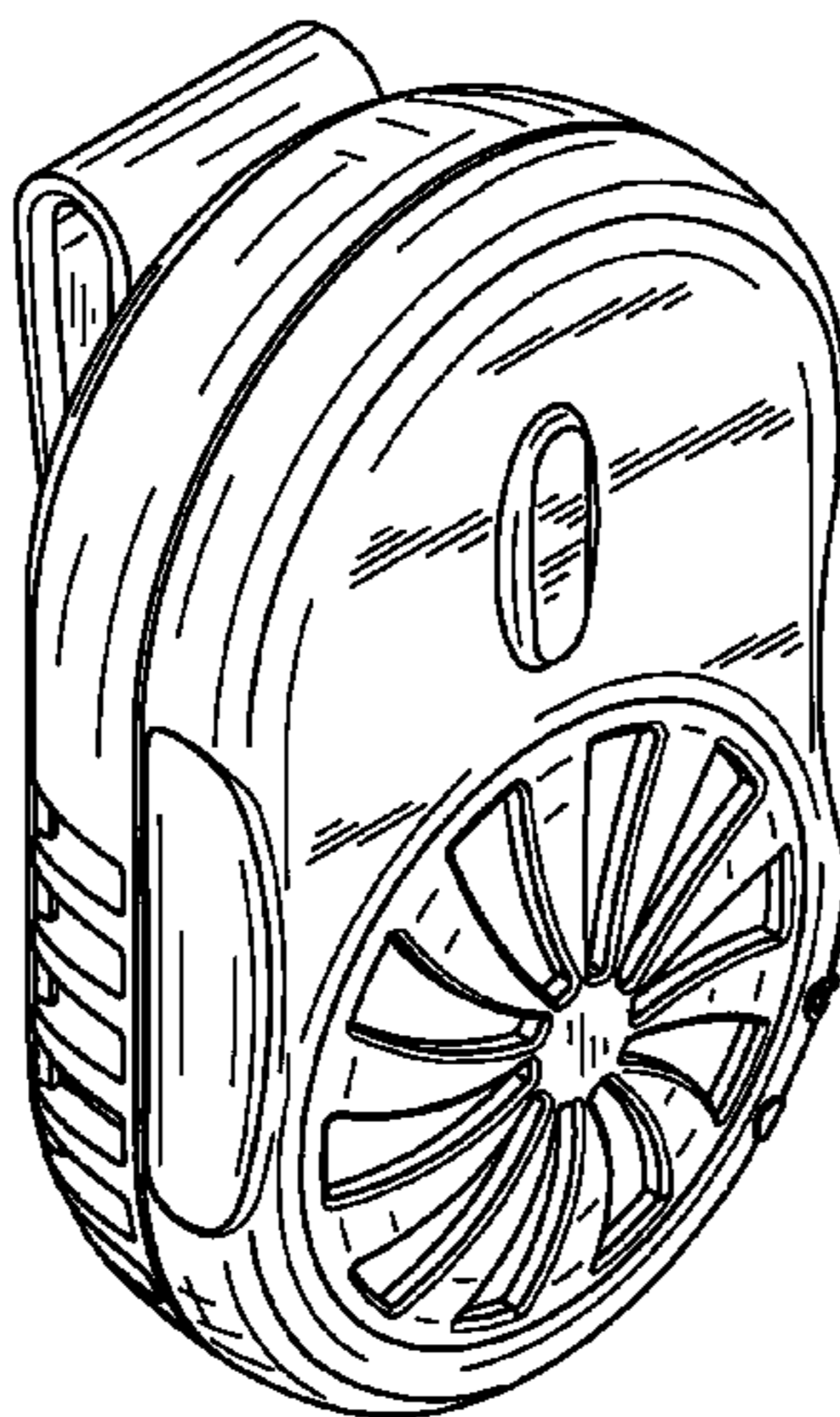

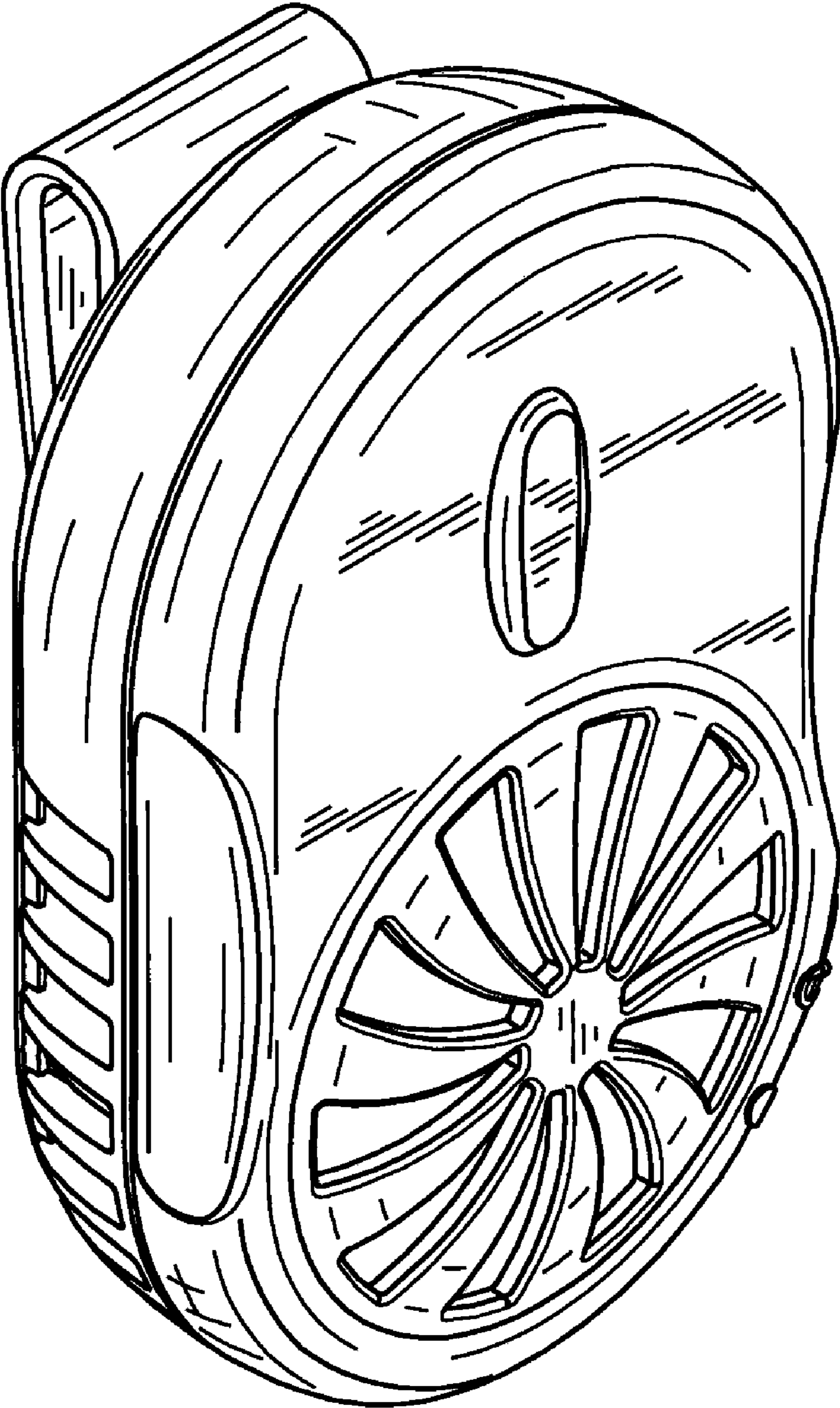

FIG. 1

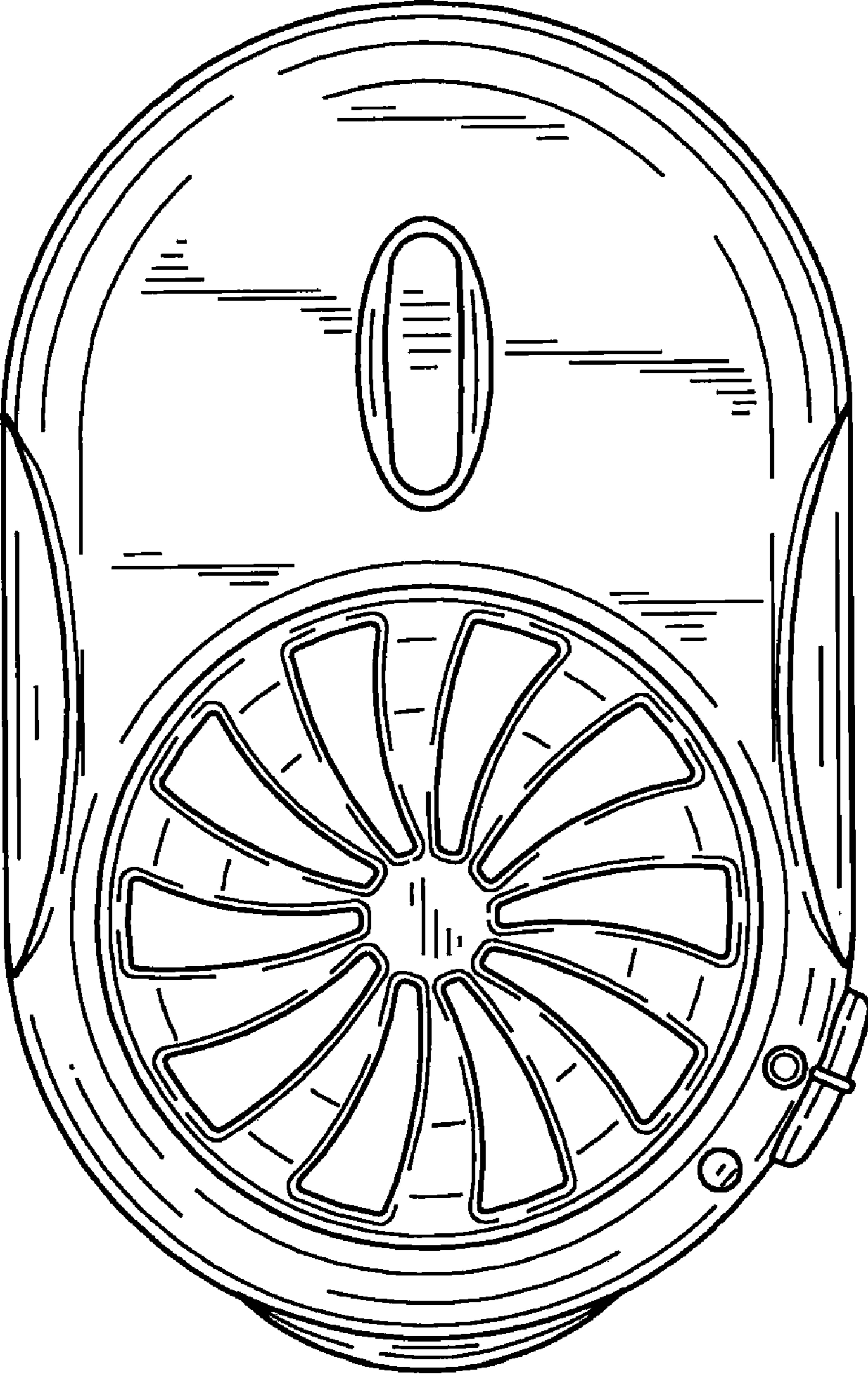

FIG. 2

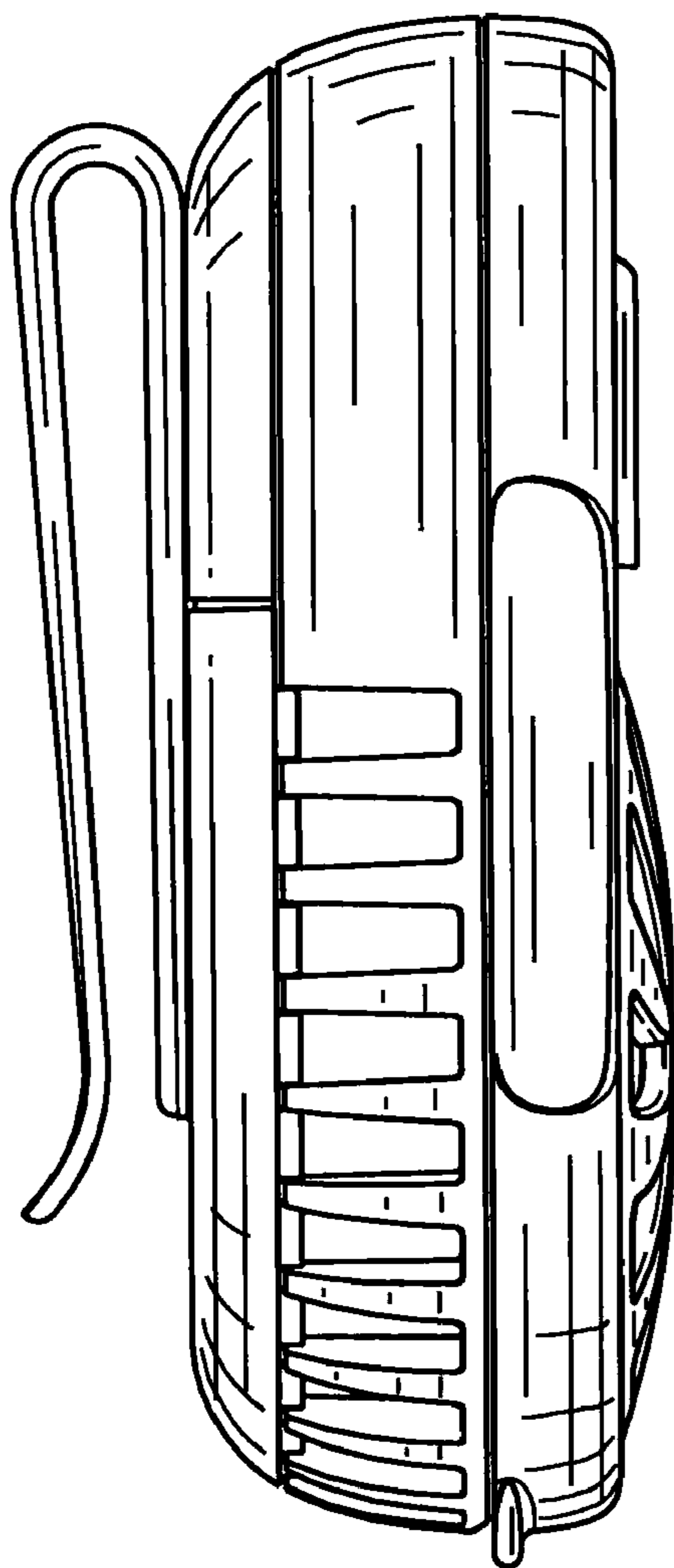

FIG. 3

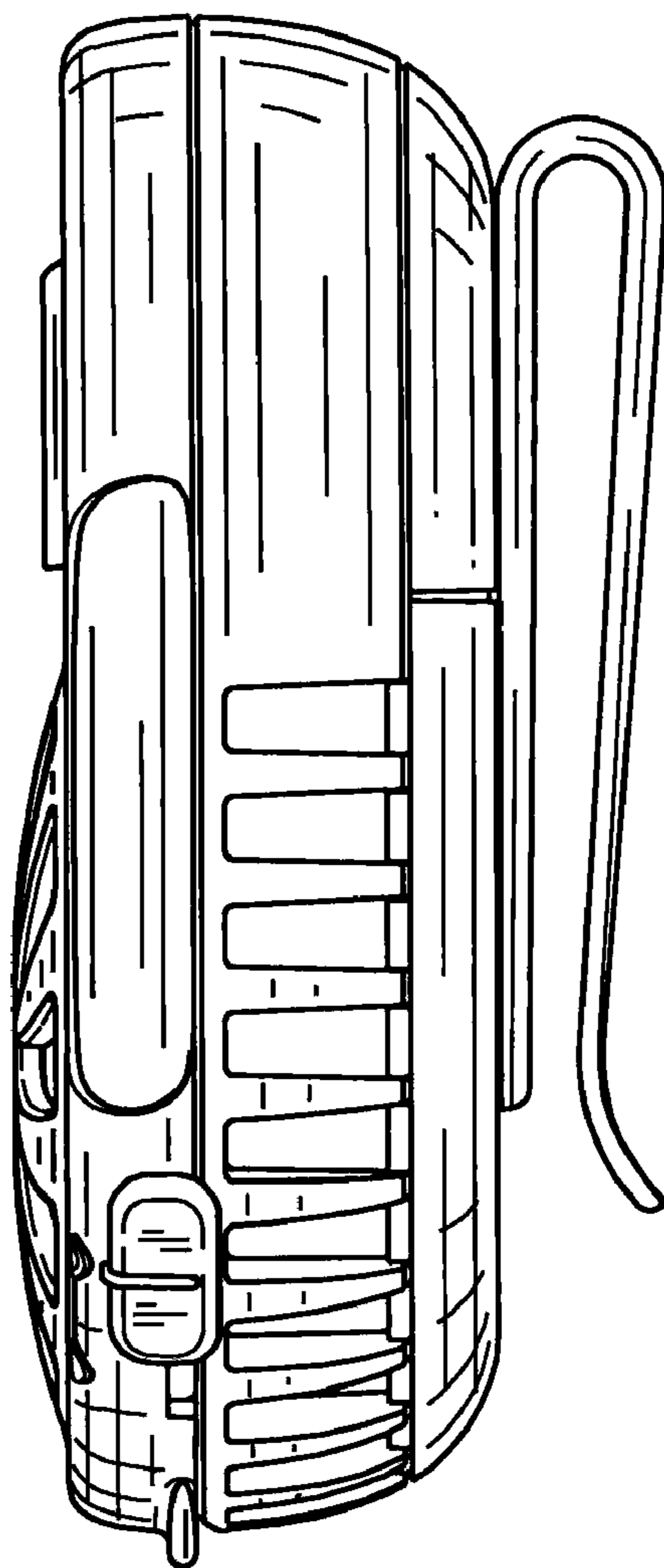

FIG. 4



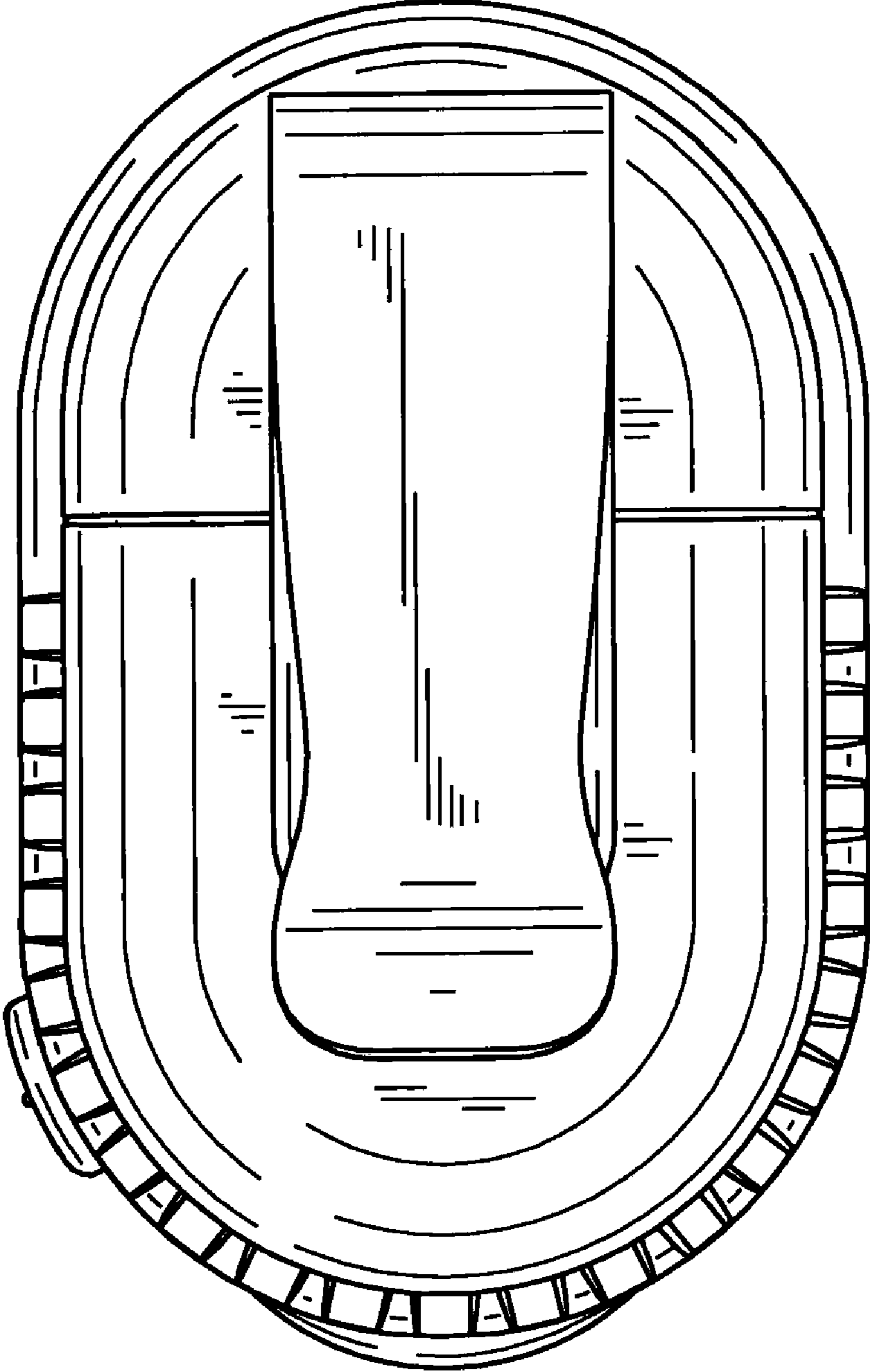

FIG. 5

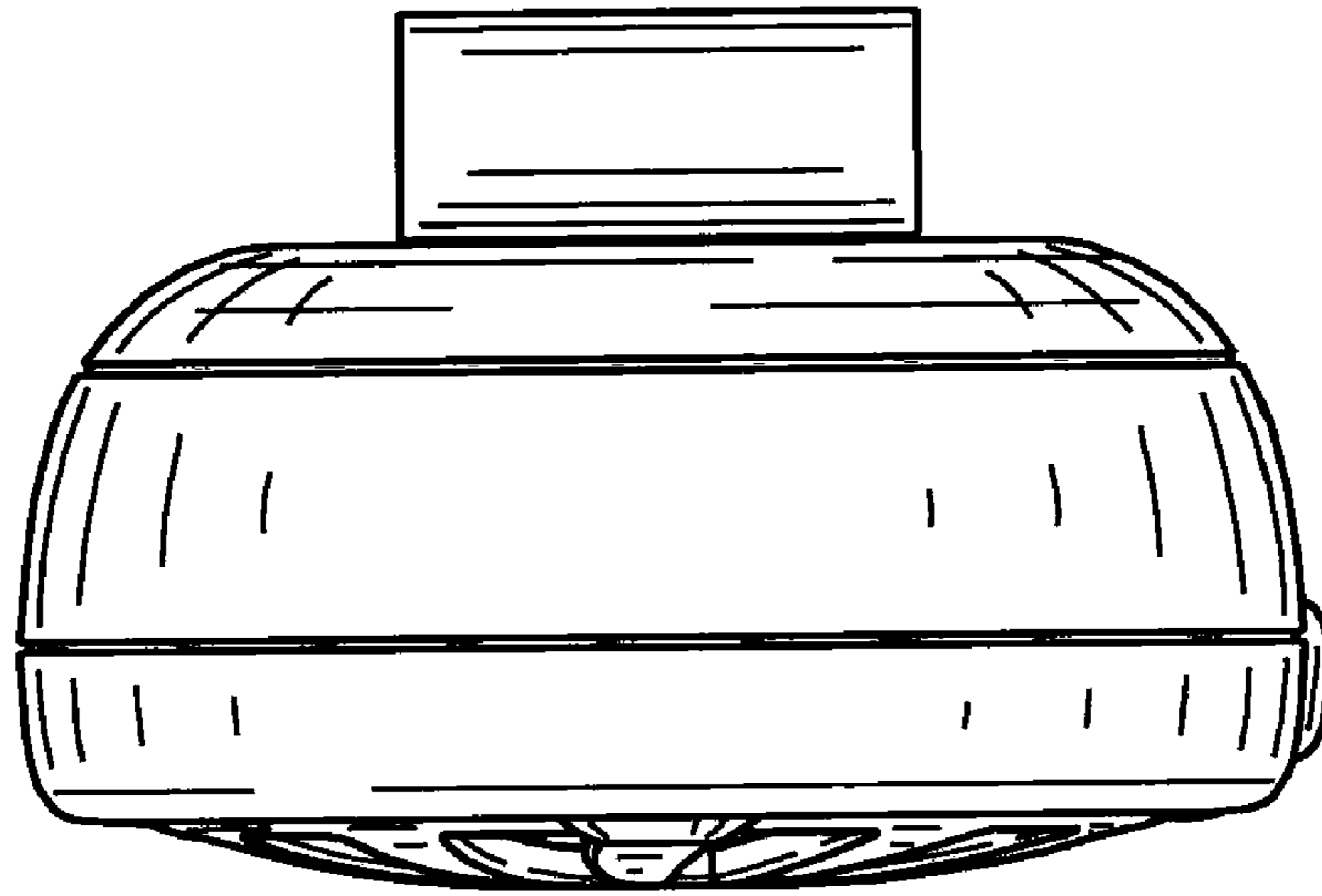

FIG. 6

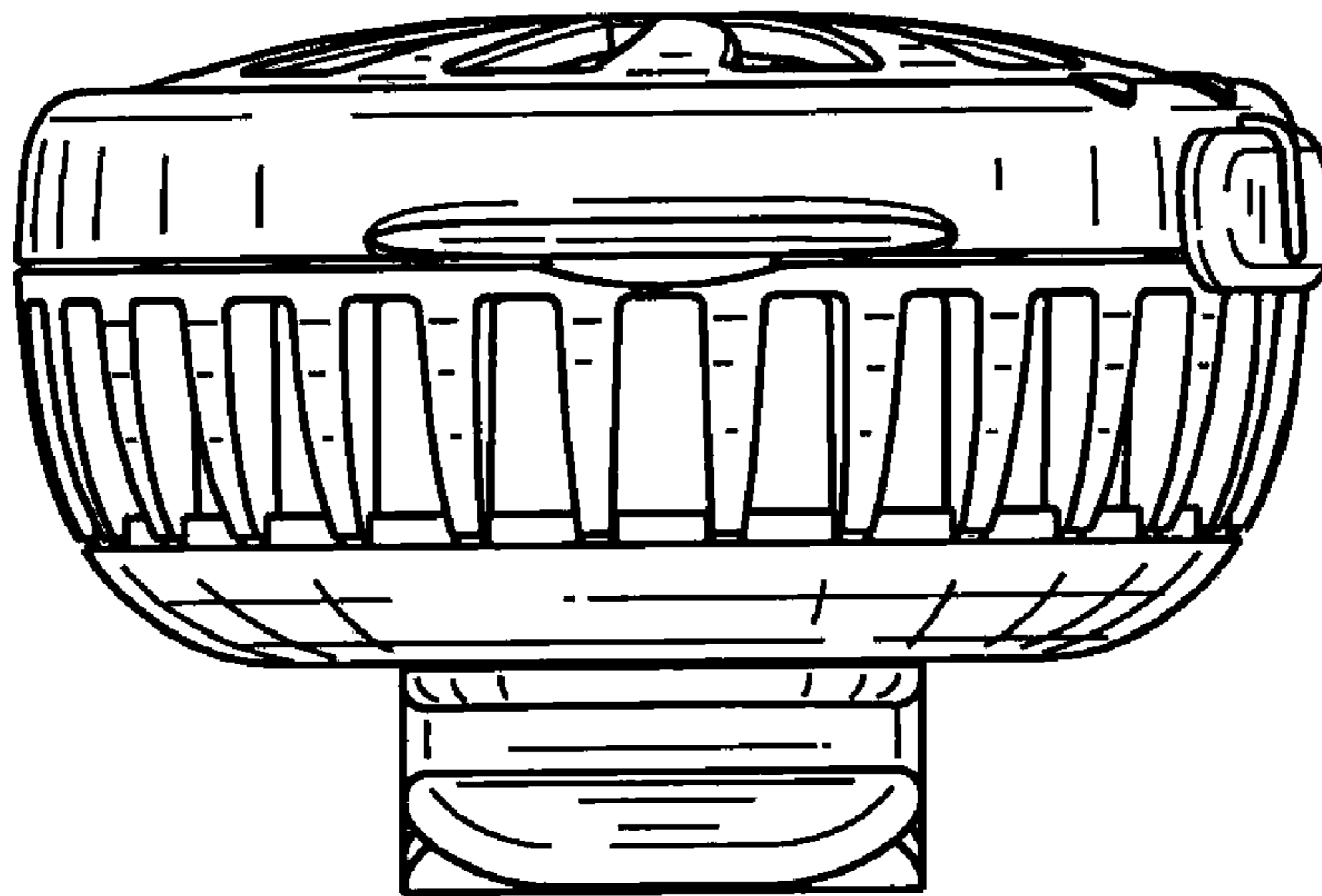

FIG. 7

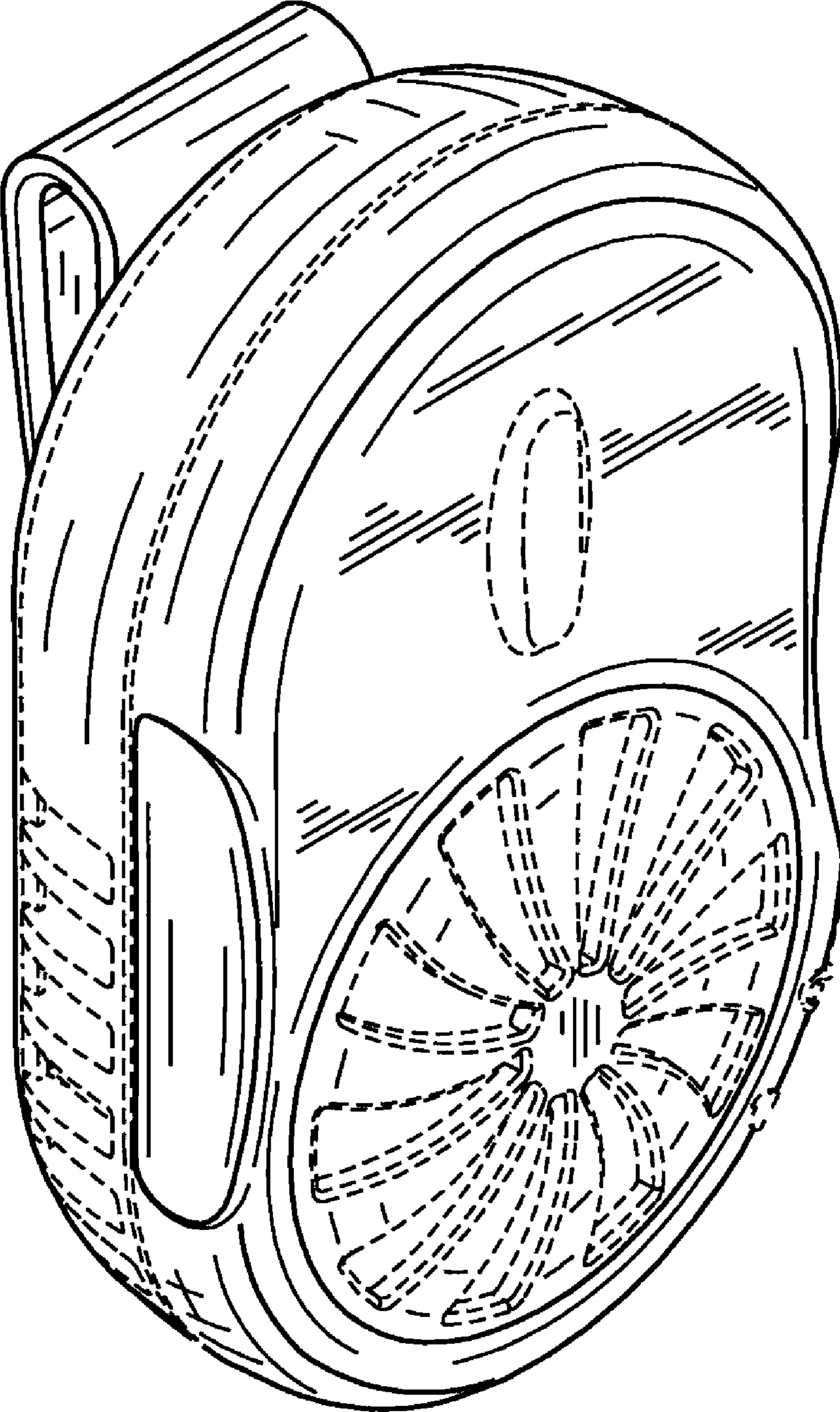

FIG. 8

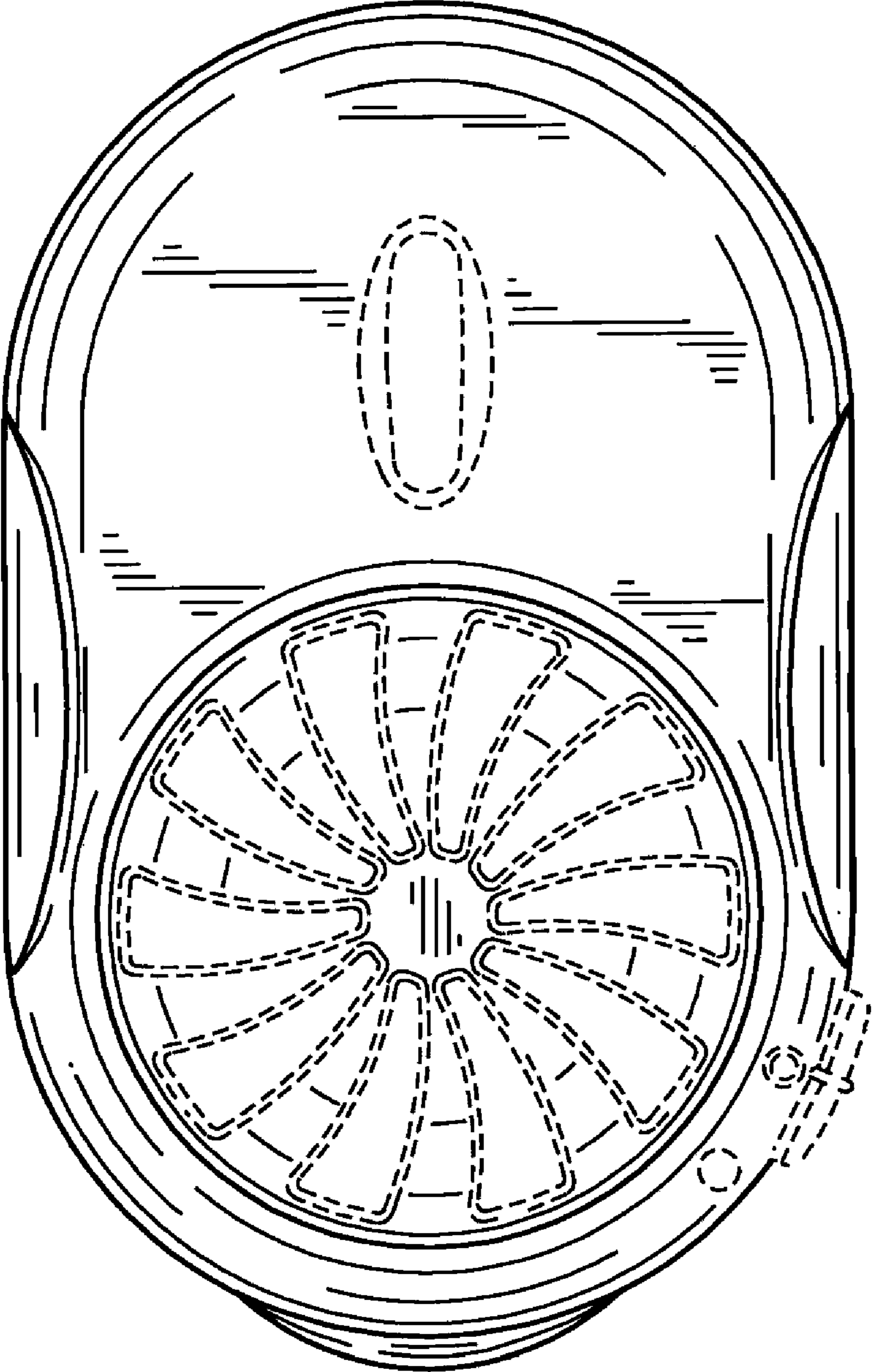

FIG. 9



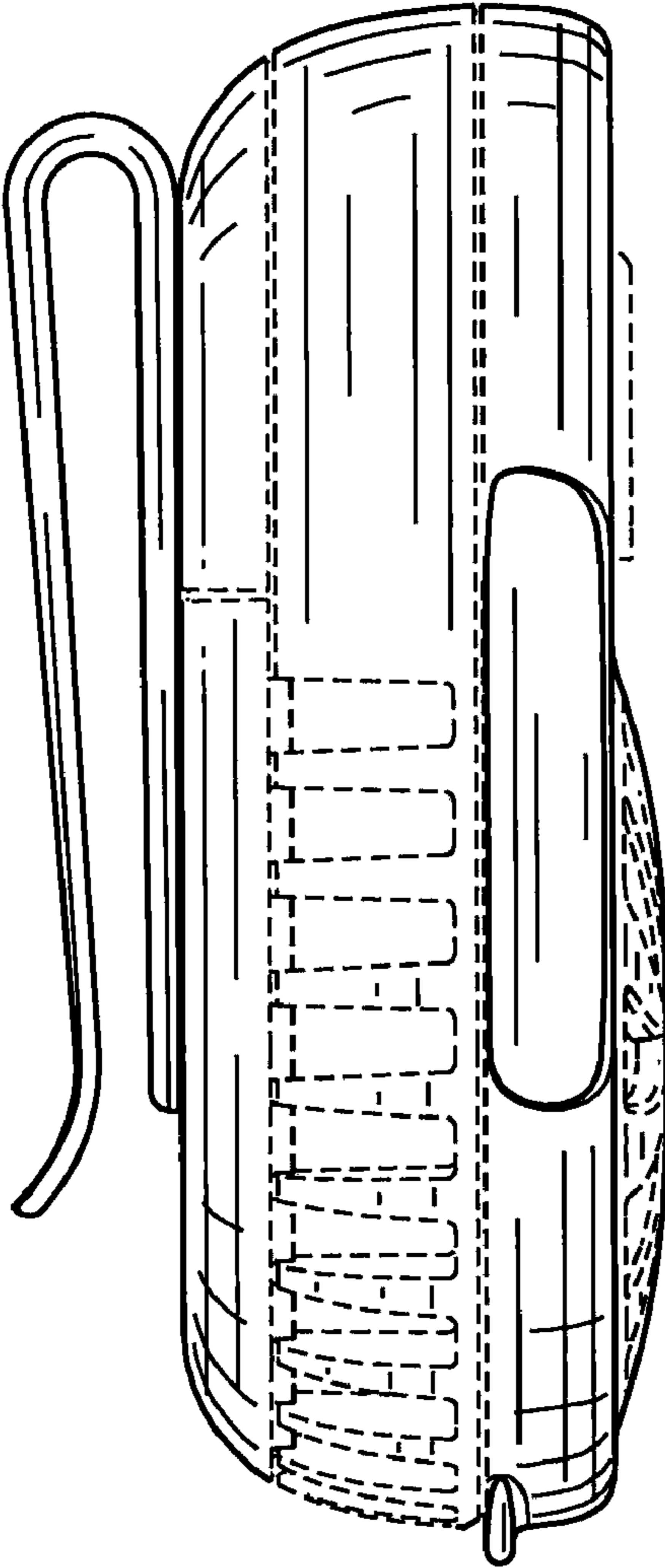

FIG. 10

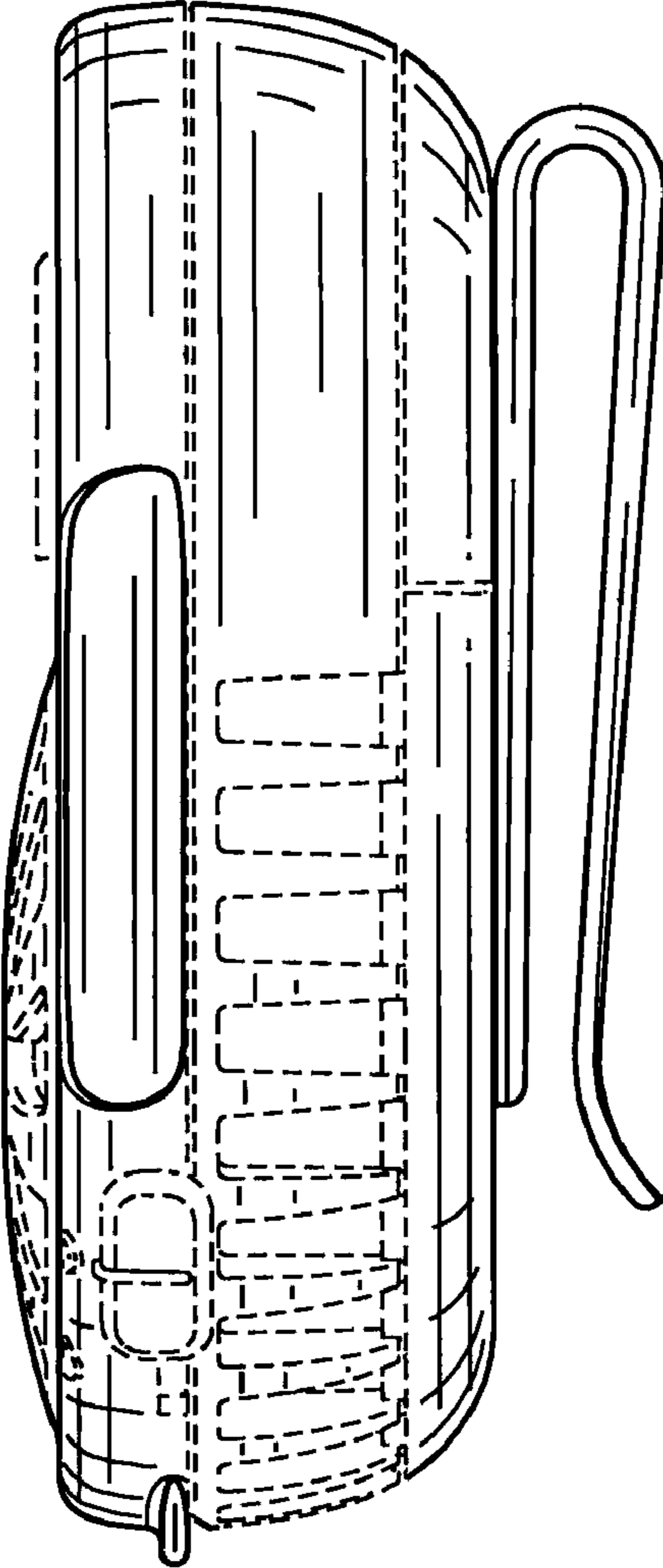

FIG. 11

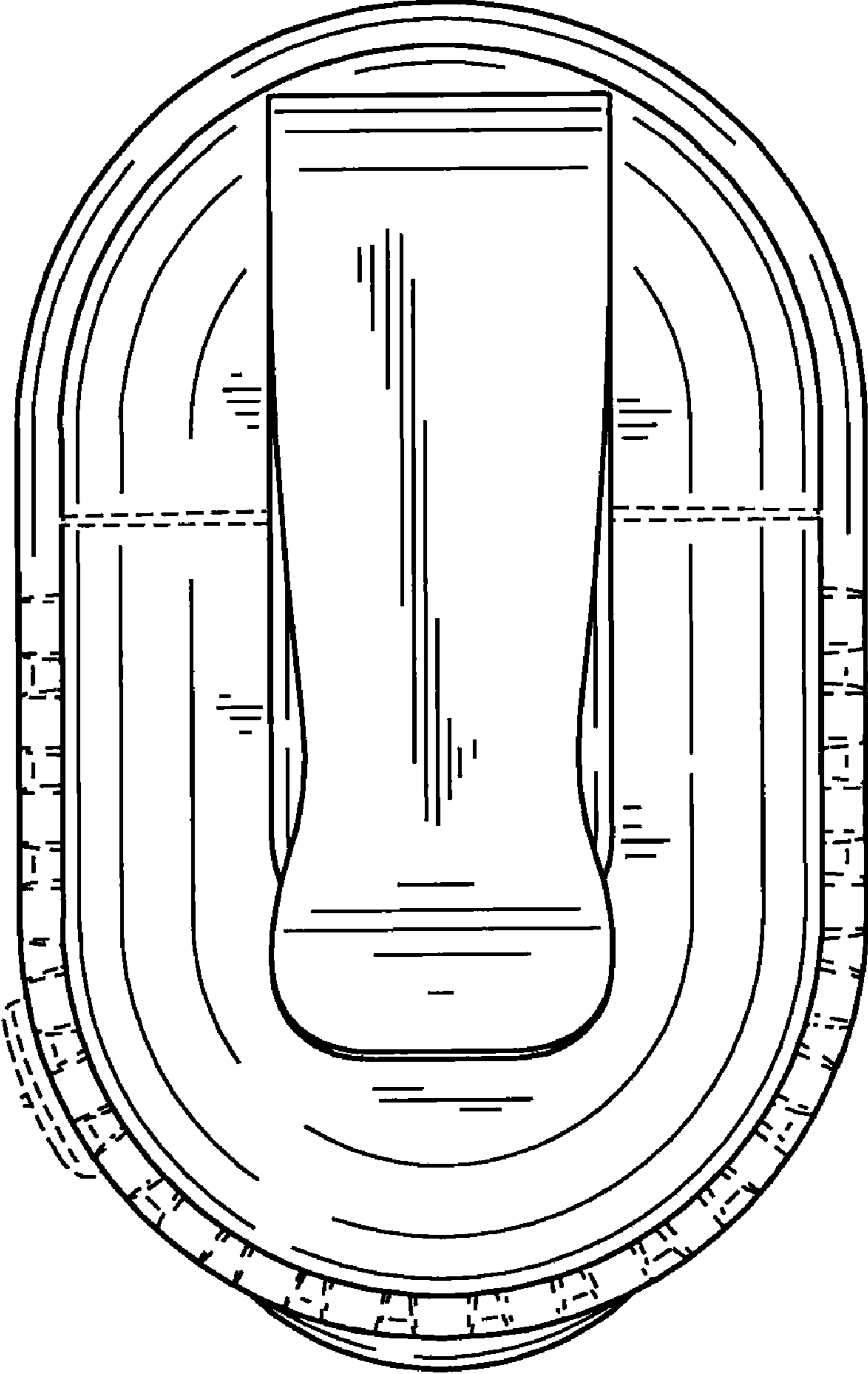

FIG. 12

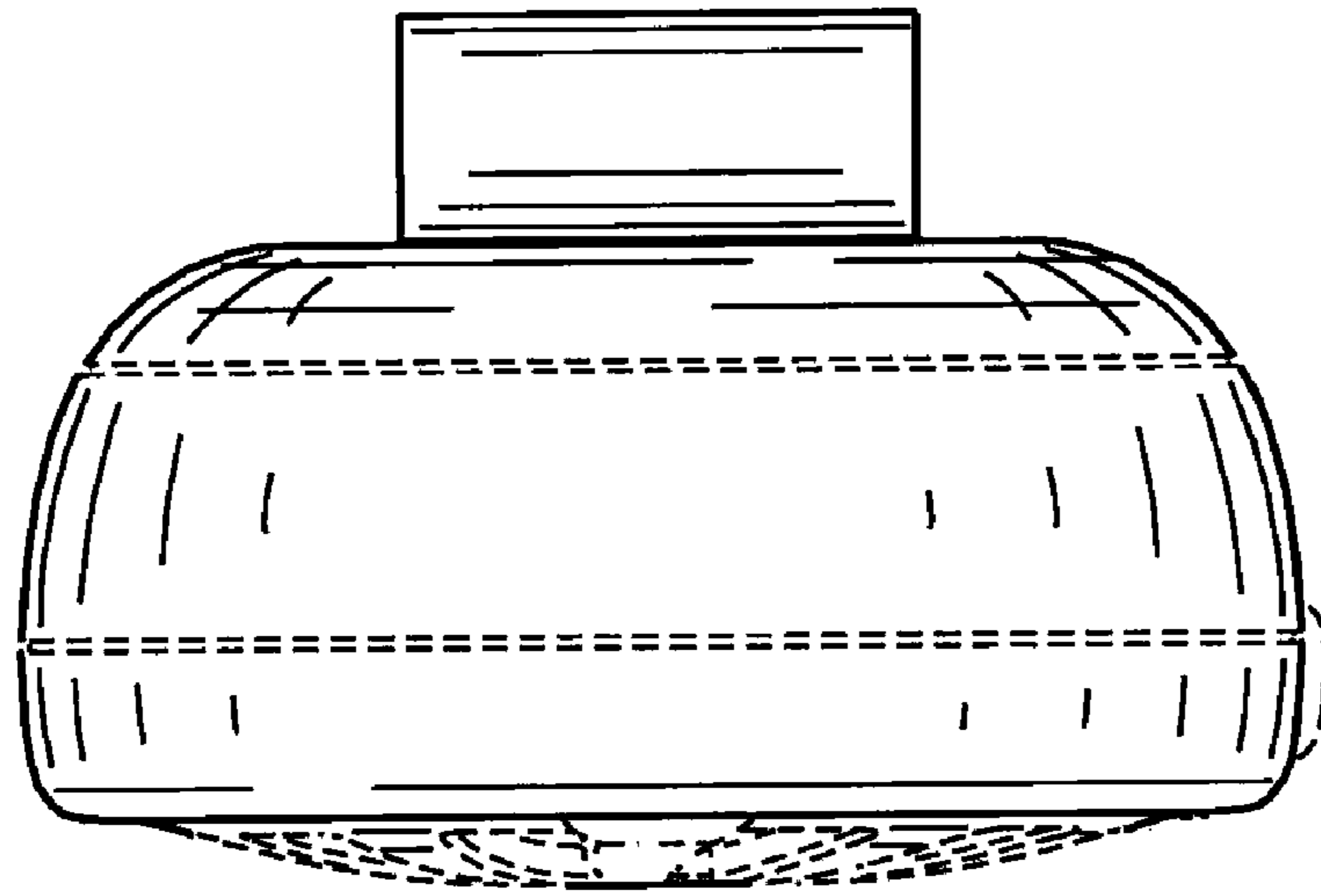

FIG. 13

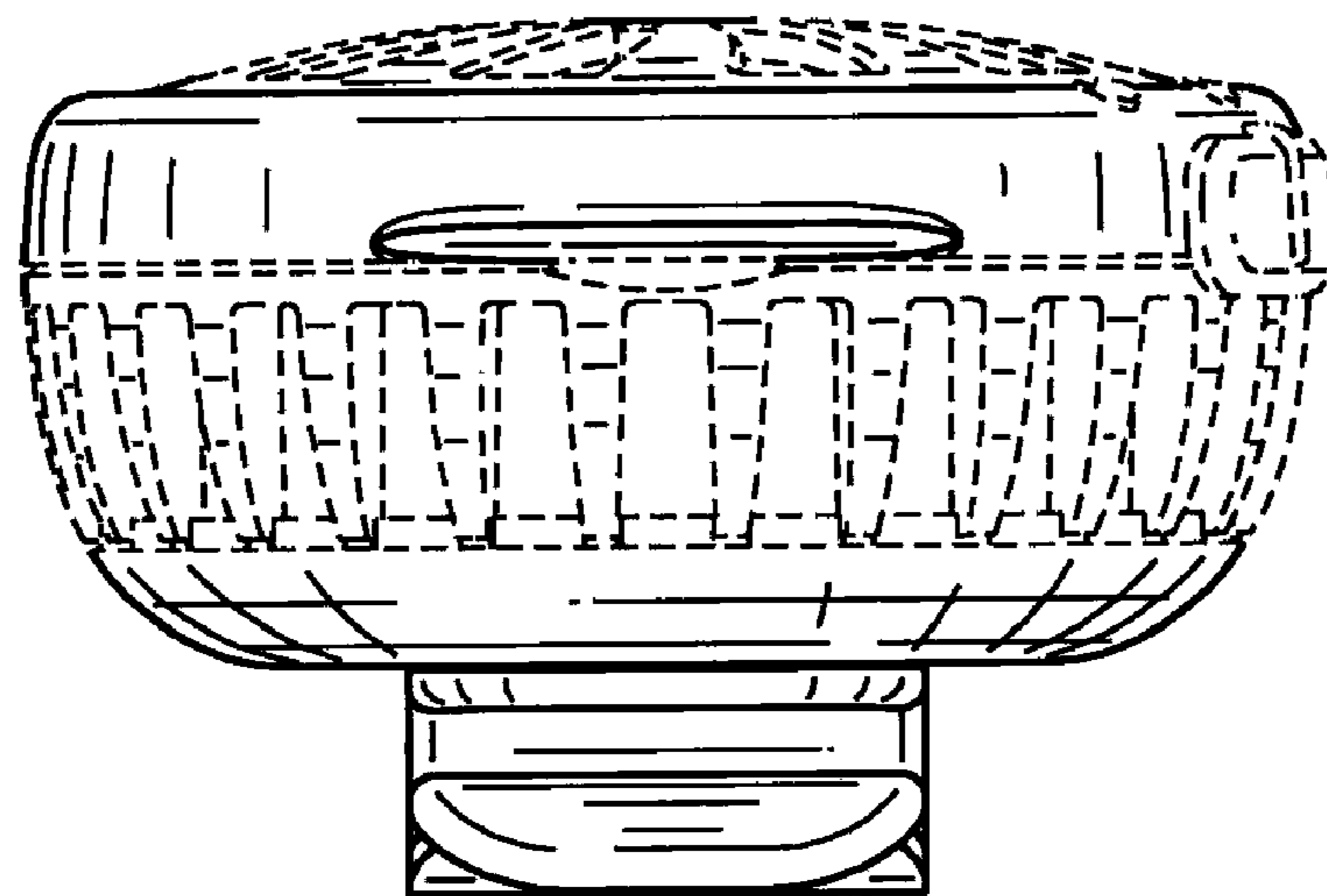

FIG. 14

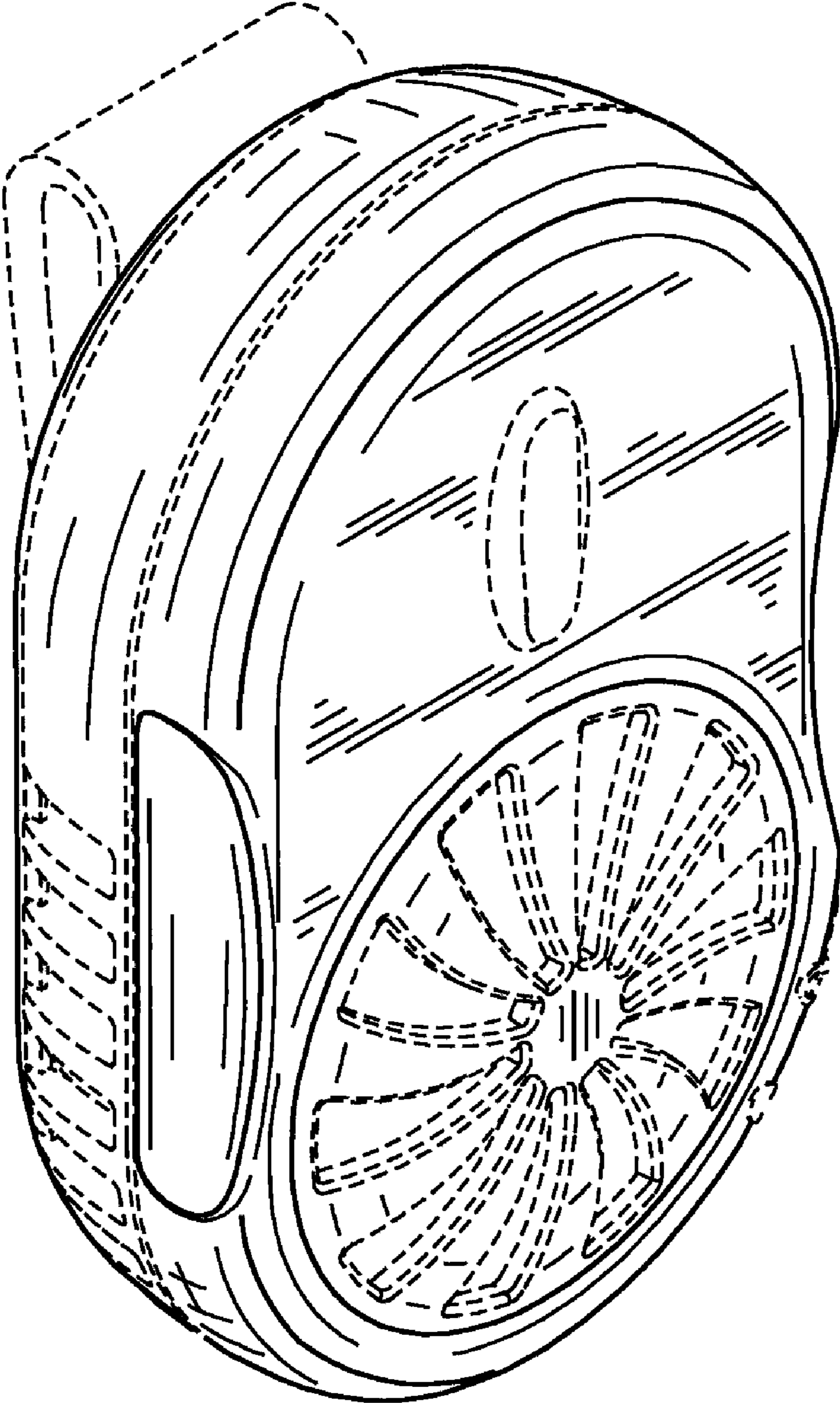

FIG. 15



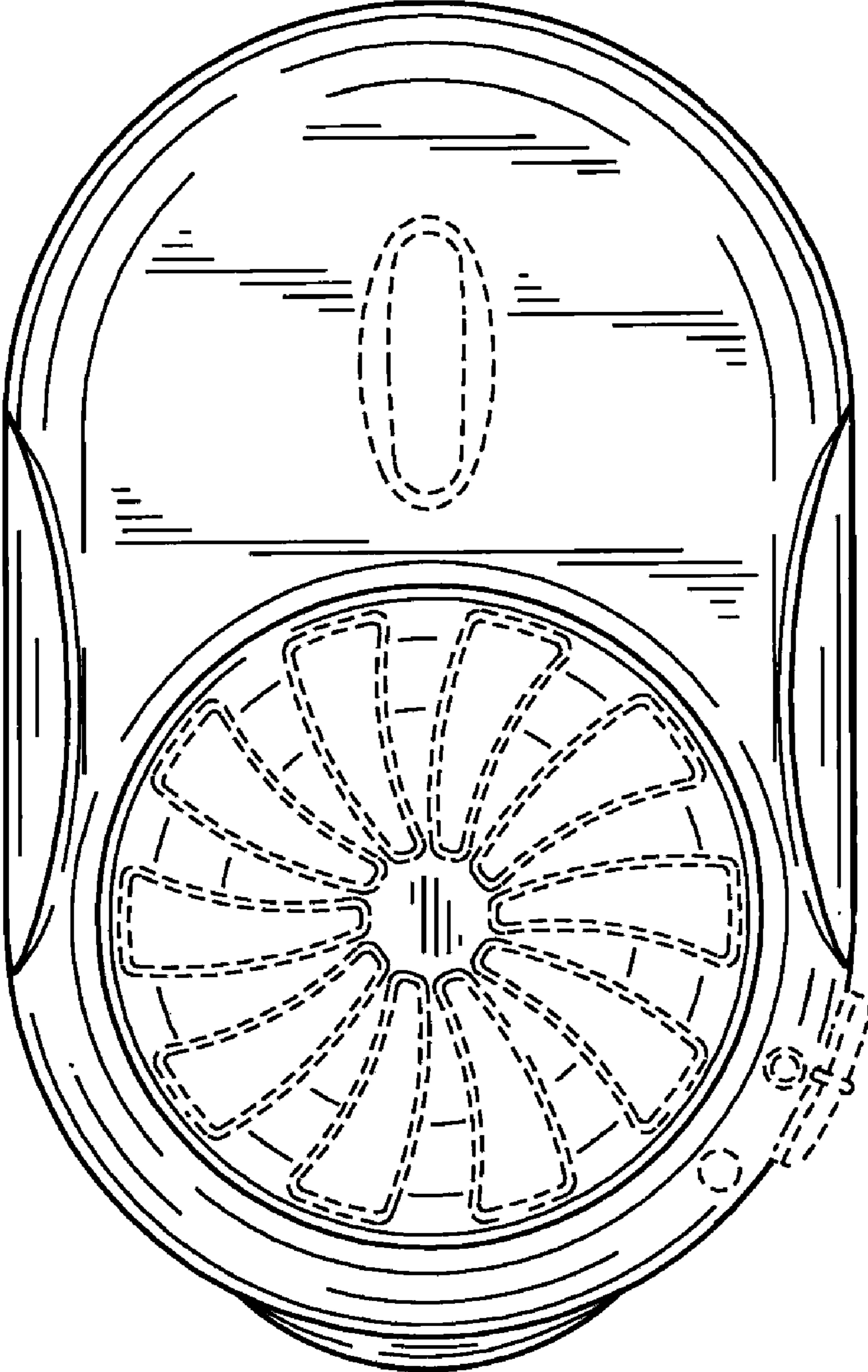

FIG. 16

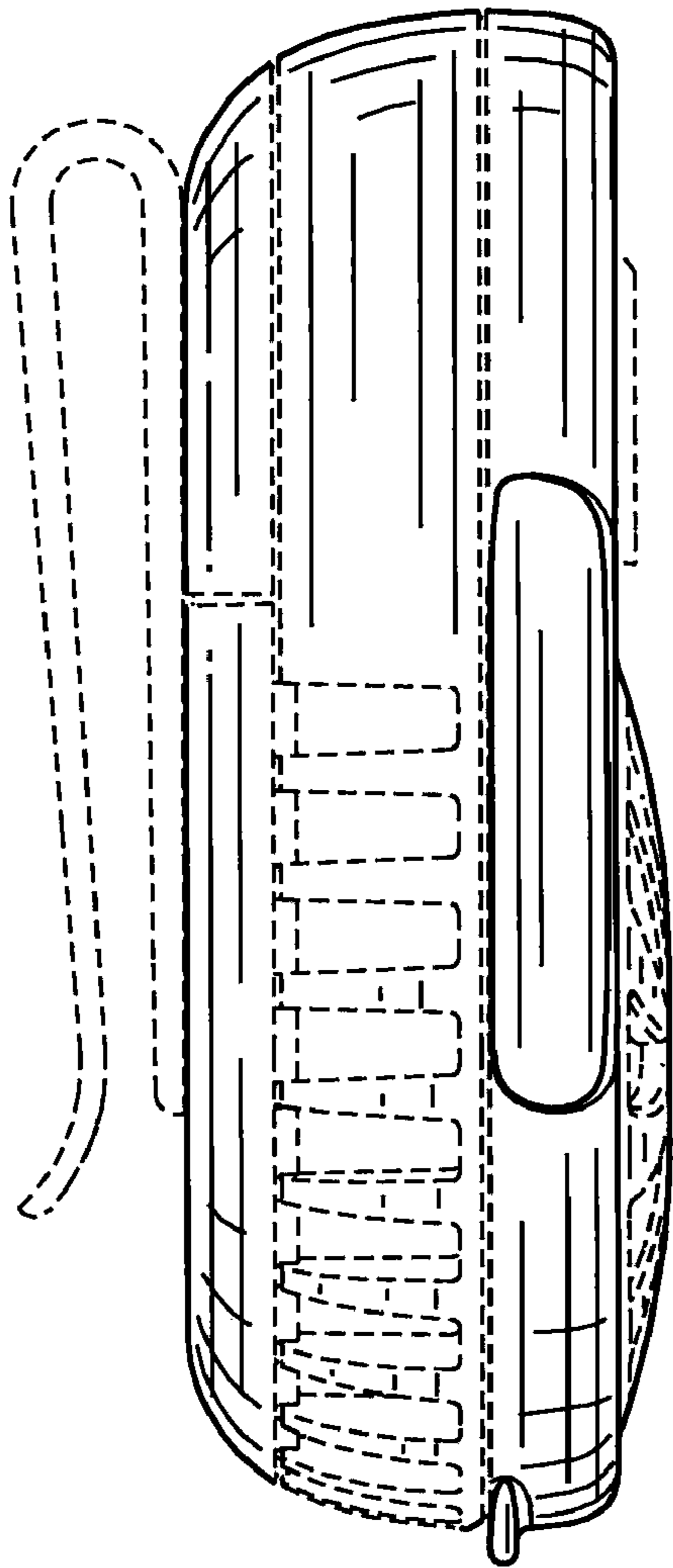

FIG. 17

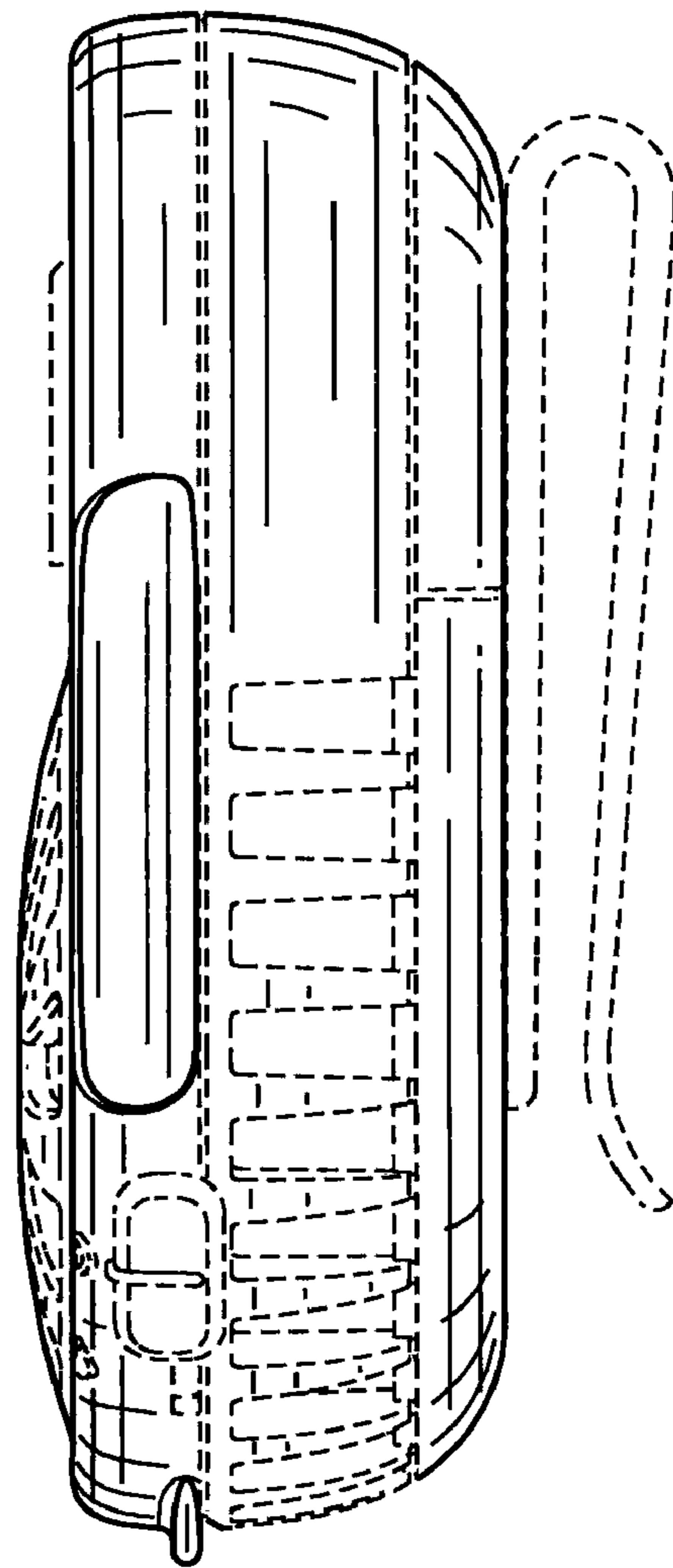

FIG. 18

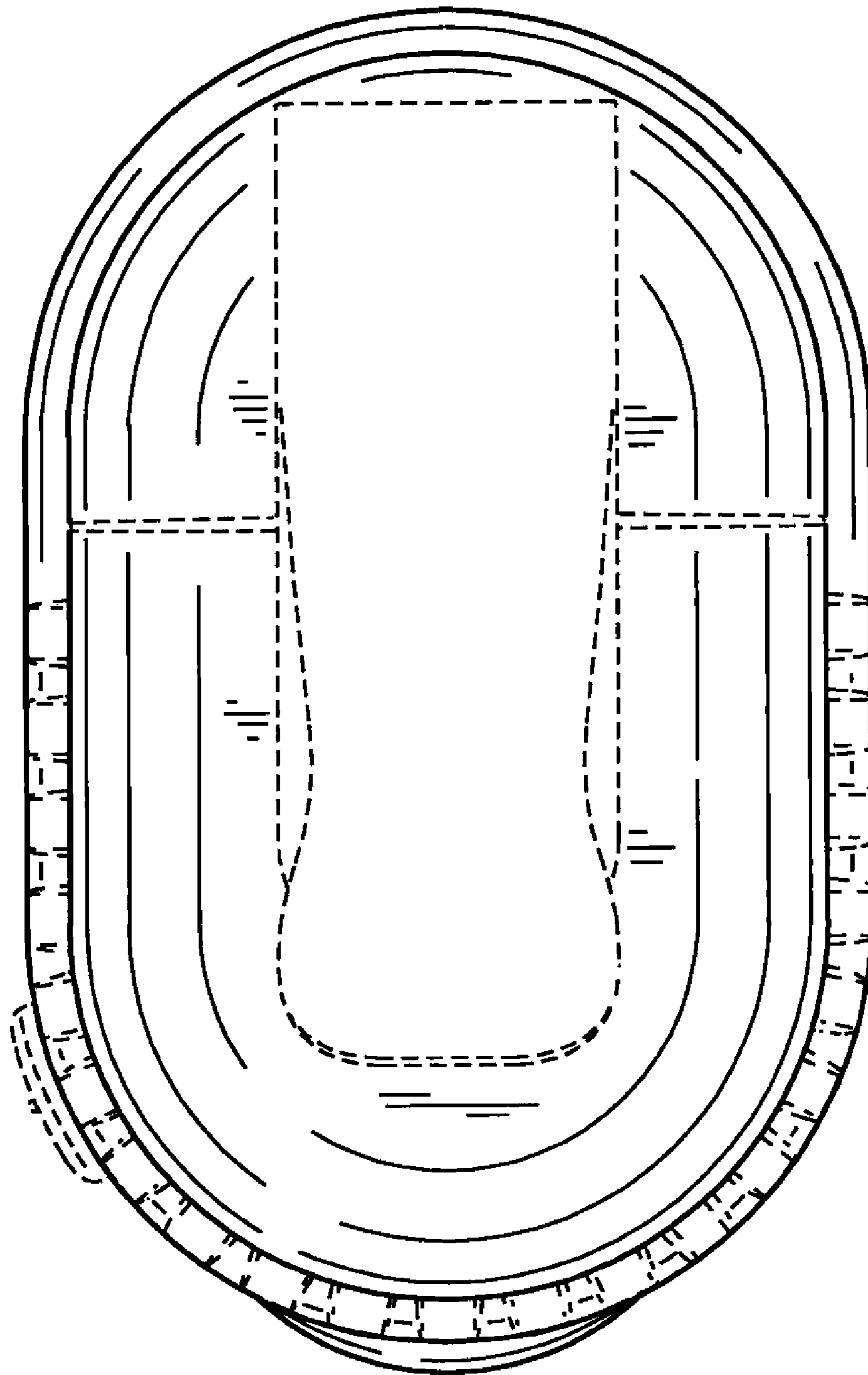

FIG. 19

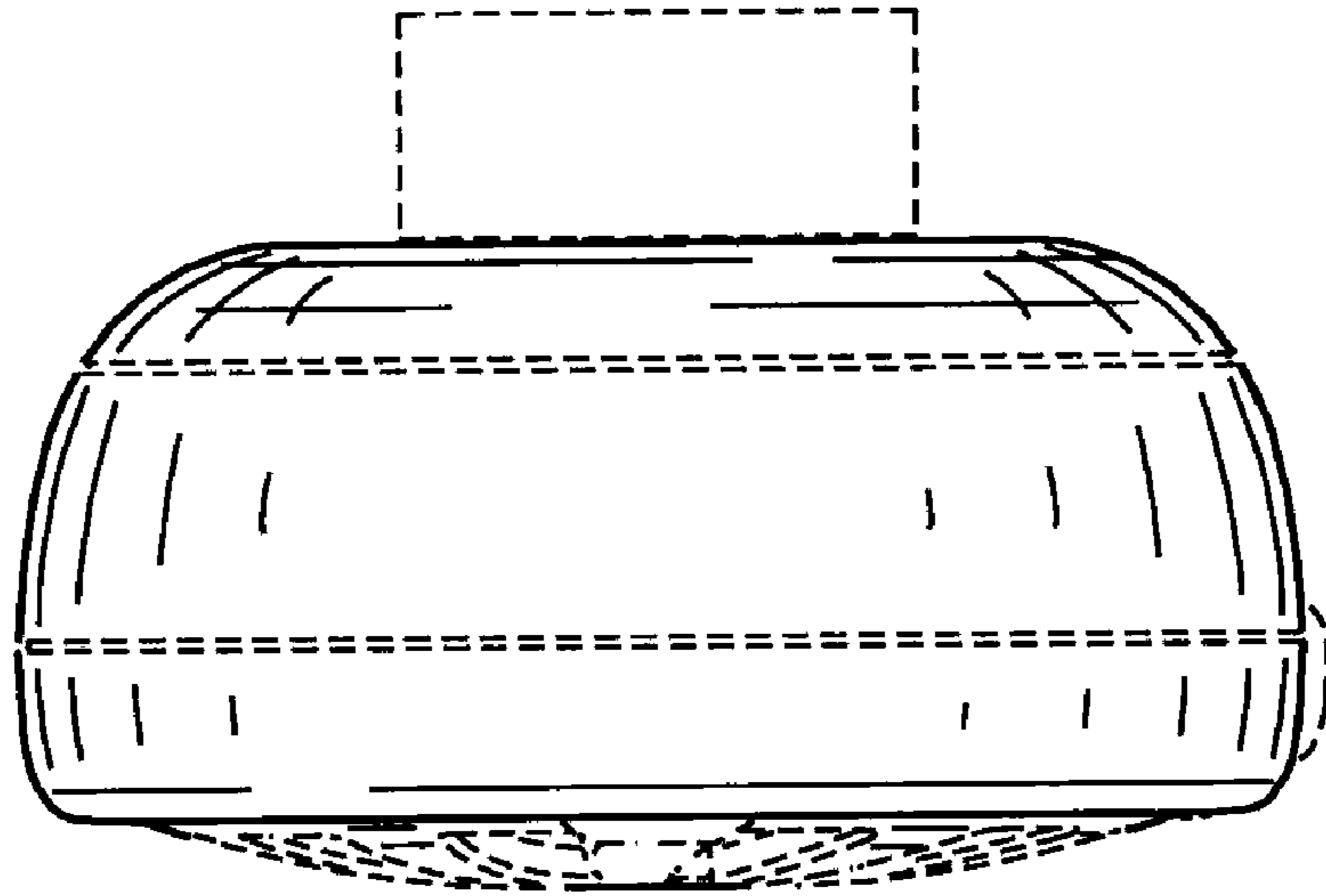

FIG. 20

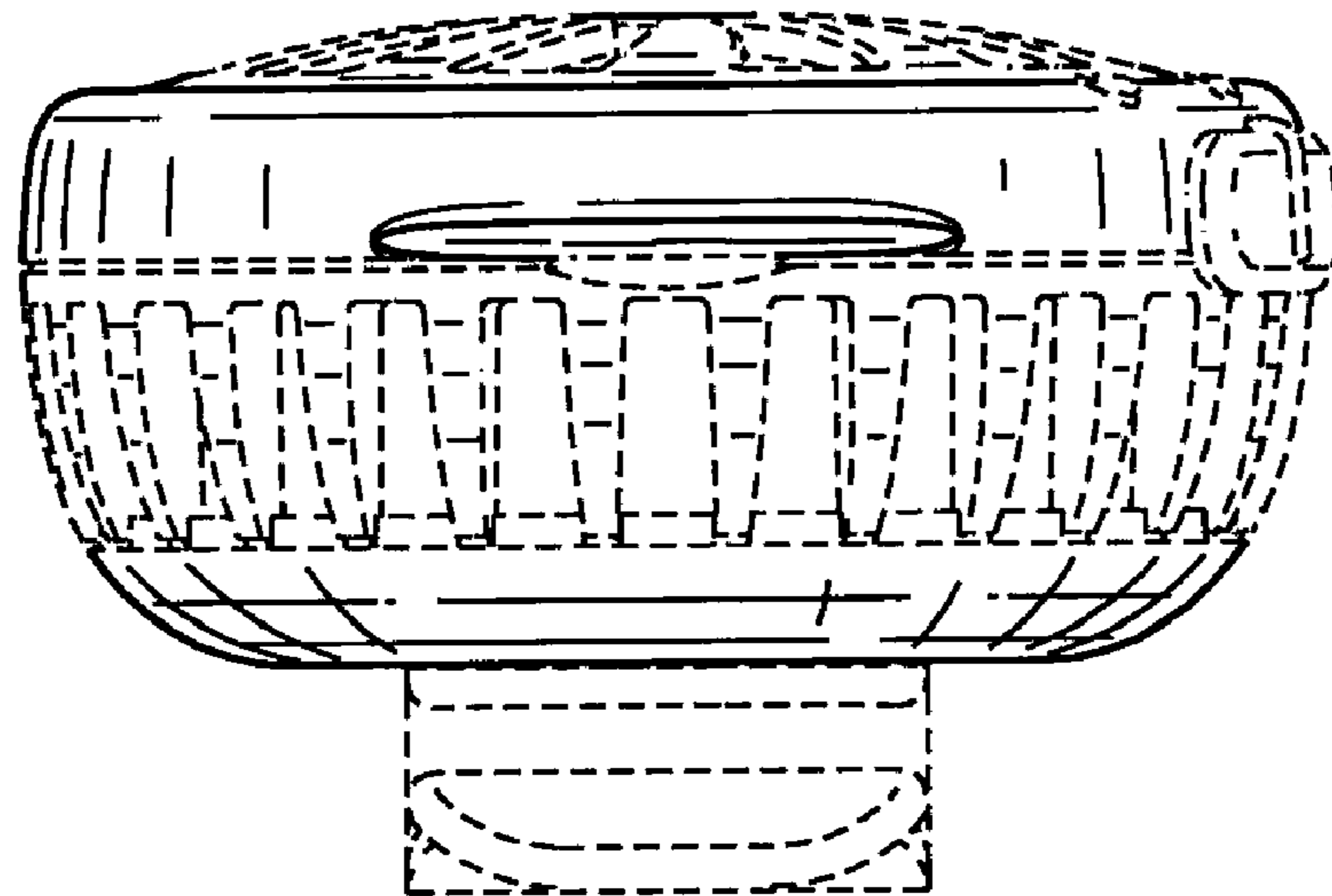

FIG. 21