



US00D610635S

(12) **United States Design Patent**
Hildebrandt et al.

(10) **Patent No.:** **US D610,635 S**

(45) **Date of Patent:** **** Feb. 23, 2010**

(54) **RECUMBENT STEPPER**

D565,129 S * 3/2008 Chang et al. D21/668

(75) Inventors: **Mark Hildebrandt**, Saline, MI (US);
Jeffrey A. DeBoer, Ann Arbor, MI (US);
Evan Carpenter Crawford, Farmington
Hills, MI (US); **James Stenz**, Fenton, MI
(US)

* cited by examiner

Primary Examiner—Philip S Hyder
Assistant Examiner—Roselynn Cody

(74) *Attorney, Agent, or Firm*—Brinks Hofer Gilson & Lione

(73) Assignee: **NuStep, Inc.**, Ann Arbor, MI (US)

(57) **CLAIM**

(**) Term: **14 Years**

The ornamental design for a recumbent stepper, as shown and described.

(21) Appl. No.: **29/297,066**

DESCRIPTION

(22) Filed: **Nov. 2, 2007**

FIG. 1 is a front perspective view of the recumbent stepper of the present invention;

(51) **LOC (9) Cl.** **21-02**

(52) **U.S. Cl.** **D21/670; D21/666**

(58) **Field of Classification Search** D21/662,
D21/666, 668, 670, 674, 694, 673, 697; 482/51,
482/52, 57, 72, 73

FIG. 2 is a front view of the recumbent stepper shown in FIG. 1;

FIG. 3 is a rear view of the recumbent stepper shown in FIG. 1;

See application file for complete search history.

FIG. 4 is a left side view of the recumbent stepper shown in FIG. 1;

(56) **References Cited**

U.S. PATENT DOCUMENTS

D321,228	S	*	10/1991	Van Der Hoeven	D21/674
5,356,356	A	*	10/1994	Hildebrandt et al.	482/62
5,445,583	A	*	8/1995	Habing	482/52
5,938,570	A	*	8/1999	Maresh	482/57
6,042,518	A	*	3/2000	Hildebrandt et al.	482/57
6,409,635	B1	*	6/2002	Maresh et al.	482/57
6,790,162	B1	*	9/2004	Ellis et al.	482/51
6,932,745	B1	*	8/2005	Ellis	482/52

FIG. 5 is a right side view of the recumbent stepper shown in FIG. 1; and,

FIG. 6 is a top view of the recumbent stepper shown in FIG. 1.

The drawings include broken lines, which depict the environmental use of the recumbent stepper and form no part of the claimed design.

1 Claim, 6 Drawing Sheets

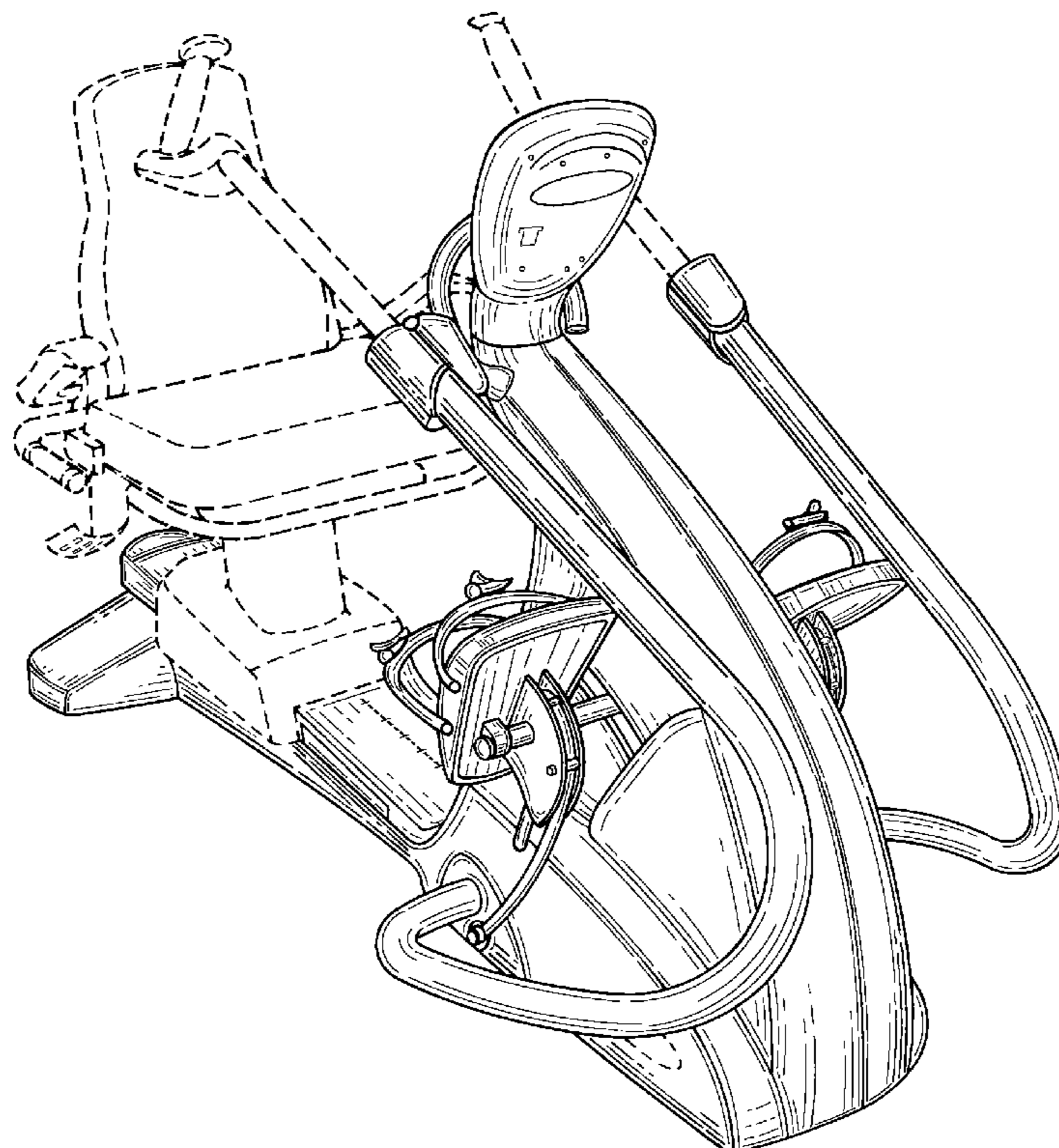

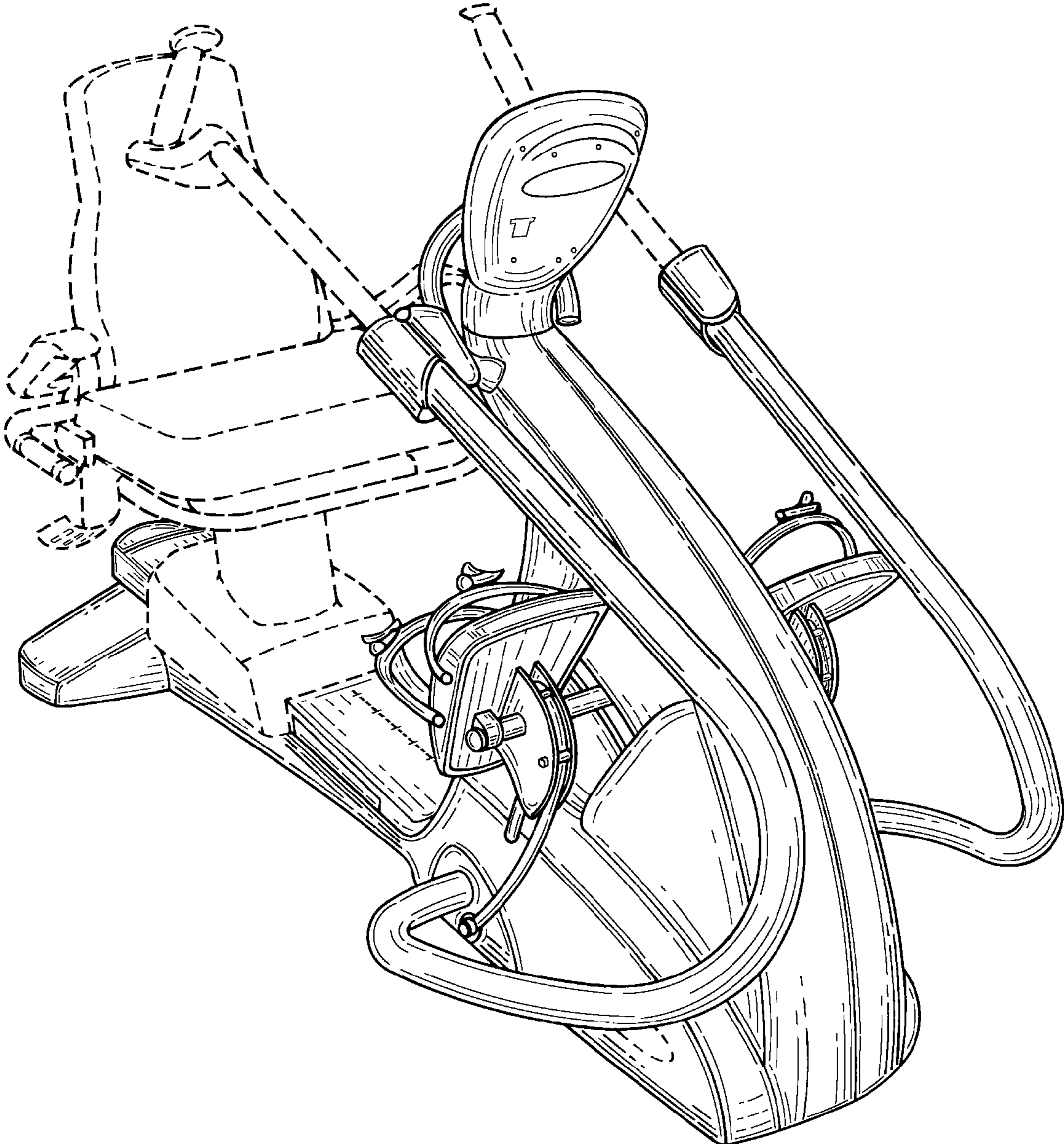

Fig. 1

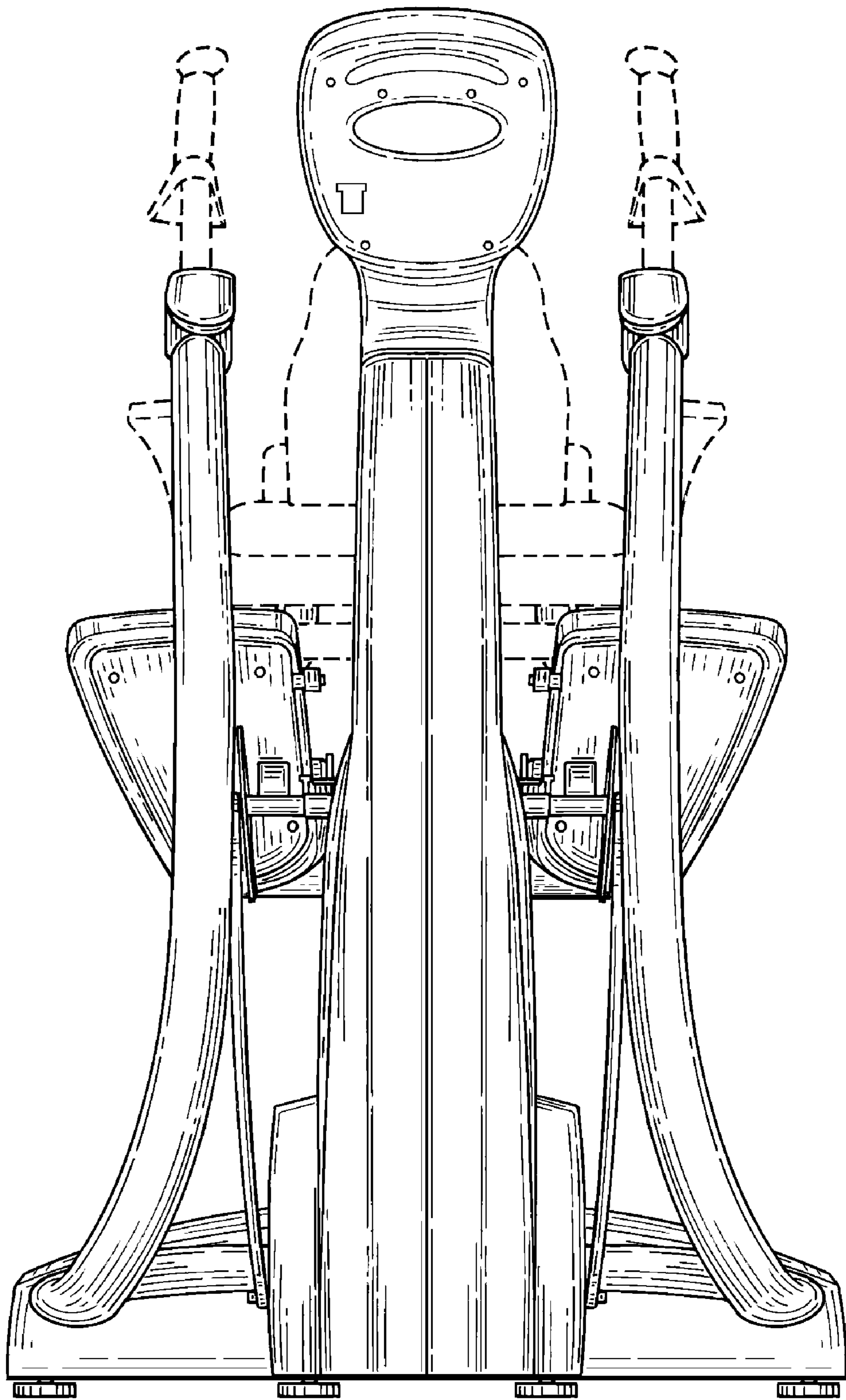

Fig. 2

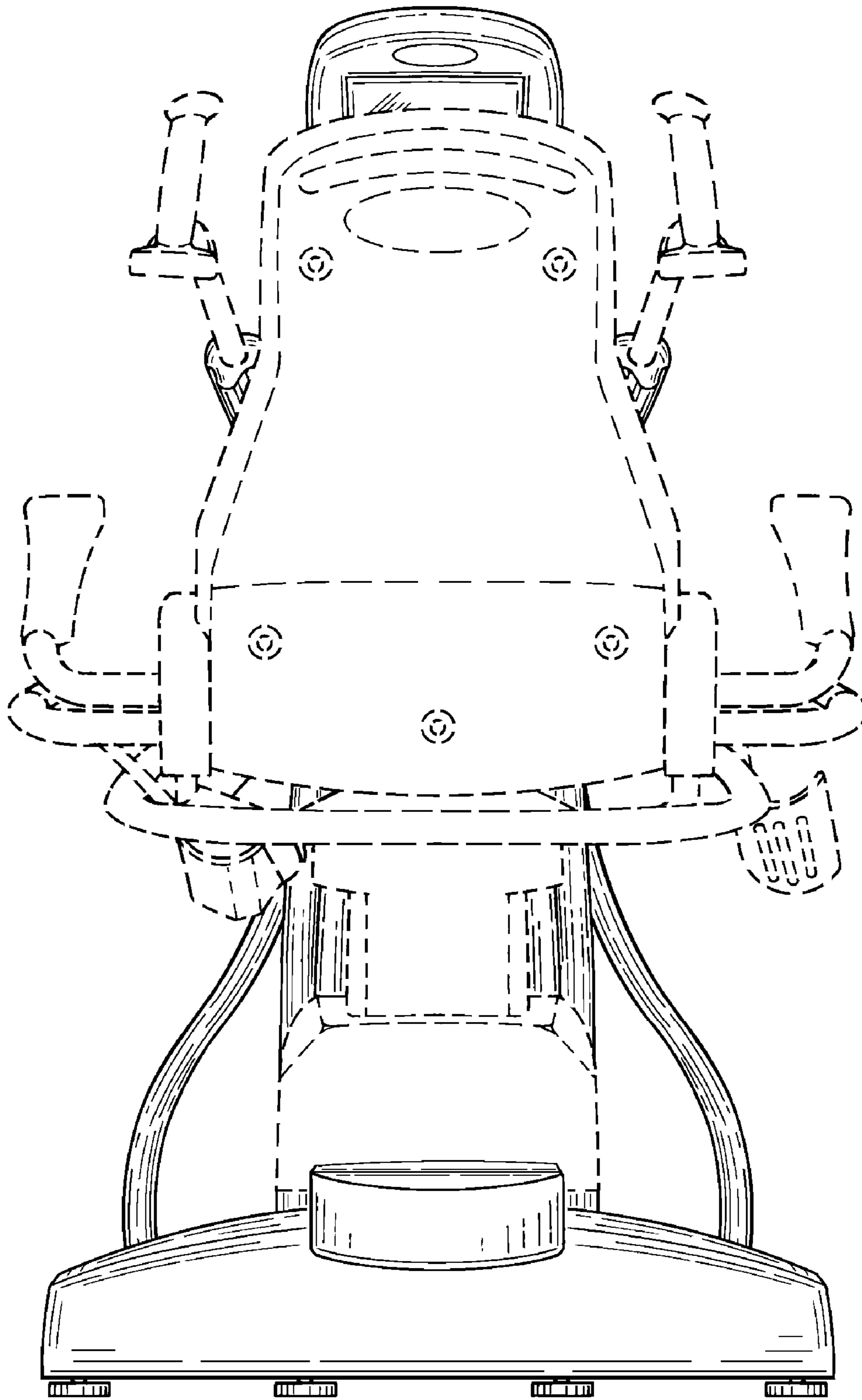

Fig. 3

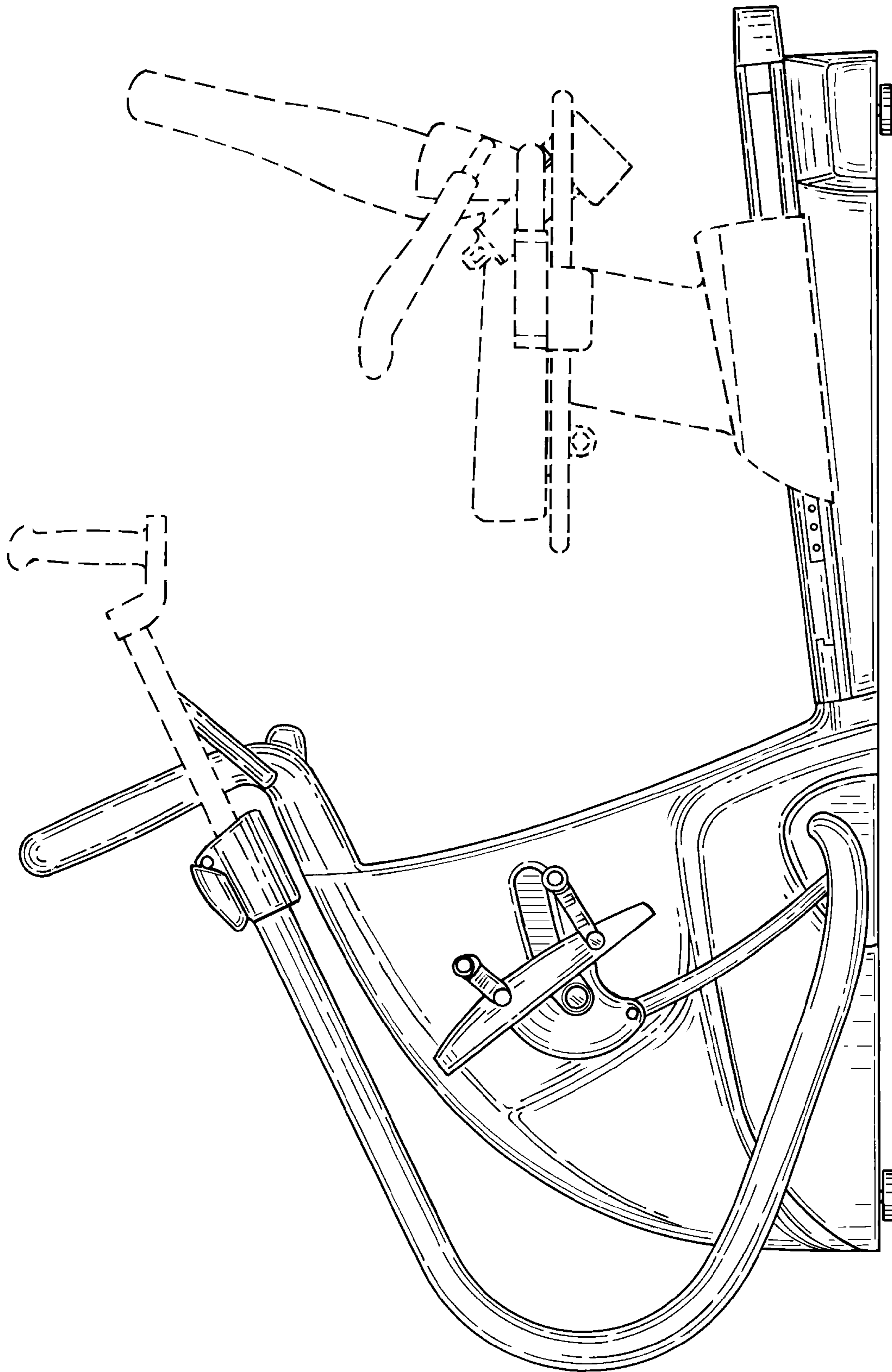

Fig. 4

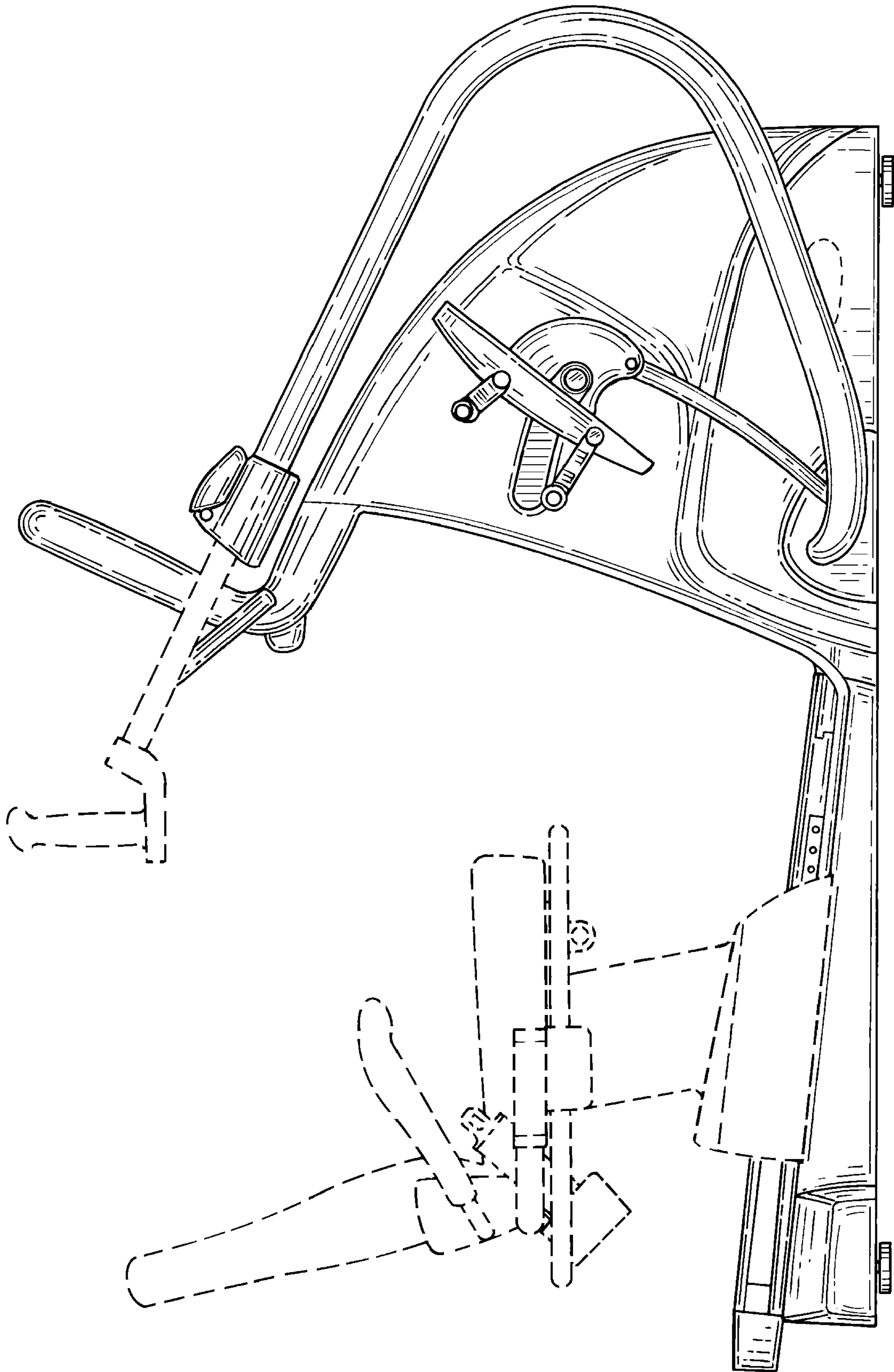

Fig. 5

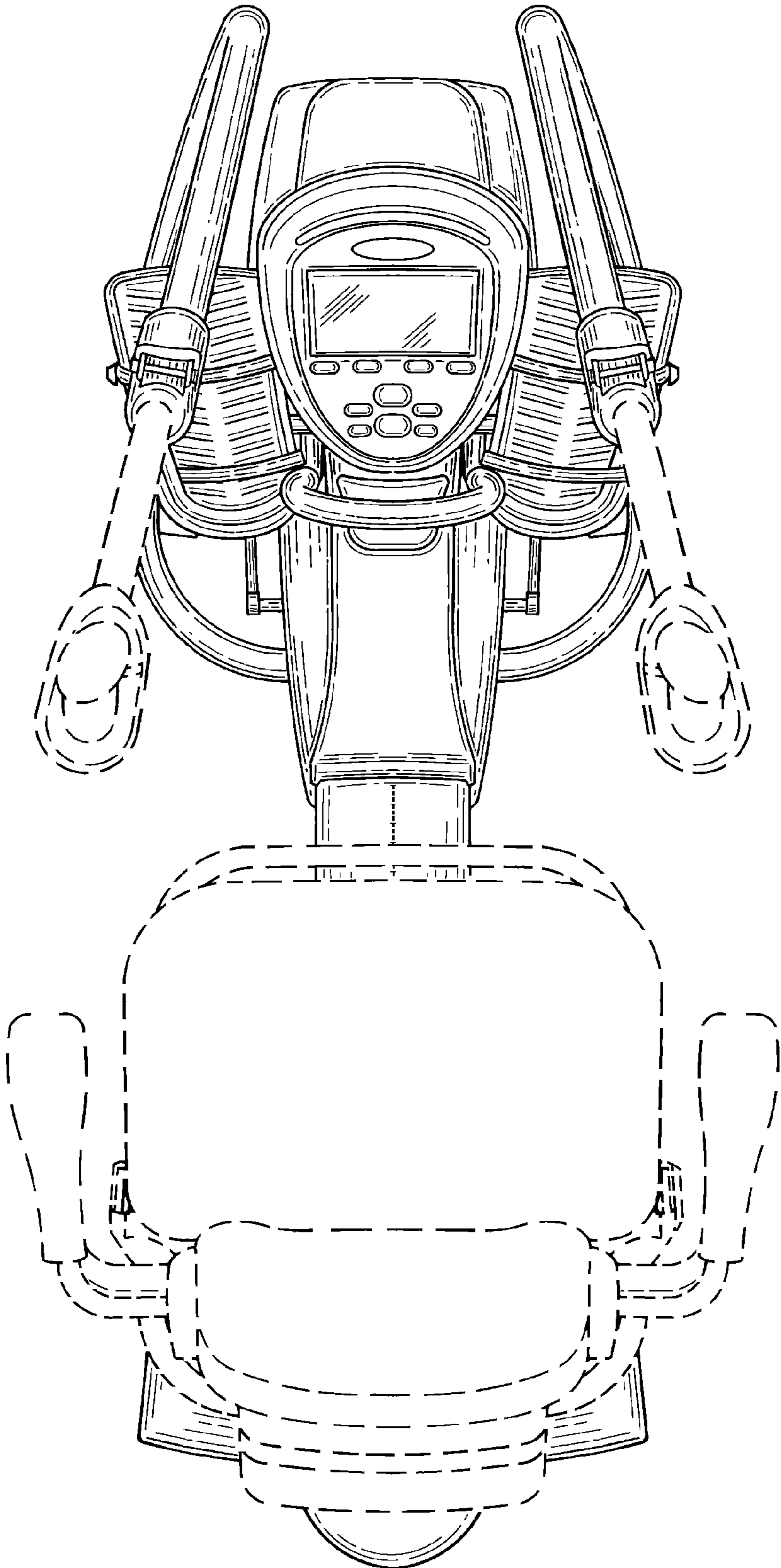

Fig. 6