



US00D610587S

(12) **United States Design Patent**
Bandringa

(10) **Patent No.:** **US D610,587 S**

(45) **Date of Patent:** **** Feb. 23, 2010**

(54) **ADJUSTABLE STAND**

(75) Inventor: **John Spencer Bandringa**, Everett, WA (US)

(73) Assignee: **Movaic, Inc.**, Everett, WA (US)

(**) Term: **14 Years**

(21) Appl. No.: **29/307,262**

(22) Filed: **Apr. 8, 2008**

(51) **LOC (9) Cl.** **08-07**

(52) **U.S. Cl.** **D14/447; D14/253**

(58) **Field of Classification Search** D14/447, D14/451, 452, 449, 251, 253, 239, 432, 434, D14/439, 448, 450, 454, 455, 457, 458, 459, D14/460, 461, 336, 337, 371, 372, 373, 374, D14/375, 376, 377, 378, 379, 380, 381, 382, D14/125, 126, 127, 129, 133, 305, 307, 335, D14/340, 339; D6/300, 308, 310, 312, 313, D6/314, 449, 512; D8/354, 363; D19/91, D19/90; 349/58, 60; 312/7.2; 348/790, 348/794, 825, 836; 211/42, 43, 126.6, 132.1, 211/171, 195; 248/917, 918, 919, 920, 921, 248/922, 923, 924, 451, 454, 460; 361/680, 361/681, 382, 683, 686

See application file for complete search history.

(56) **References Cited**

U.S. PATENT DOCUMENTS

1,026,523	A	5/1912	Maxwell	
2,441,655	A	5/1948	Anderson	
2,648,931	A *	8/1953	Deveau	248/460
3,057,591	A *	10/1962	Weimer	248/166
D249,953	S *	10/1978	Drake	D19/91
D291,628	S *	9/1987	Poltere	D6/310
4,940,204	A	7/1990	Nelson et al.	
D394,160	S *	5/1998	Yarbrough	D6/310
D422,417	S	4/2000	Walters-Dowding	

(Continued)

Primary Examiner—Jennifer Rivard

Assistant Examiner—Angela J Lee

(74) *Attorney, Agent, or Firm*—Joseph F. Murphy, Jr.

(57) **CLAIM**

The ornamental design for an adjustable stand, as shown in the figures.

DESCRIPTION

FIG. 1 is a top view of the adjustable stand shown in a flat position;

FIG. 2 is a front view thereof, the rear view being a mirror image thereof;

FIG. 3 is a bottom view thereof;

FIG. 4 is a side view thereof, the opposite side being a mirror image thereof;

FIG. 5 is an isometric view thereof;

FIG. 6 is another isometric view thereof;

FIG. 7 is a right side view of the adjustable stand shown in a folded position;

FIG. 8 is a top view thereof;

FIG. 9 is a front view thereof;

FIG. 10 is a bottom view thereof;

FIG. 11 is a left side view thereof;

FIG. 12 is a rear view thereof;

FIG. 13 is an isometric view thereof;

FIG. 14 is a right side view of the adjustable stand shown in another folded position;

FIG. 15 is a top view thereof;

FIG. 16 is a front view thereof;

FIG. 17 is a bottom view thereof;

FIG. 18 is a left side view thereof;

FIG. 19 is a rear view thereof; and,

FIG. 20 is an isometric view thereof.

The broken lines and the broken line showing of a computer are included for the purpose of illustrating environment and form no part of the claimed design.

1 Claim, 6 Drawing Sheets

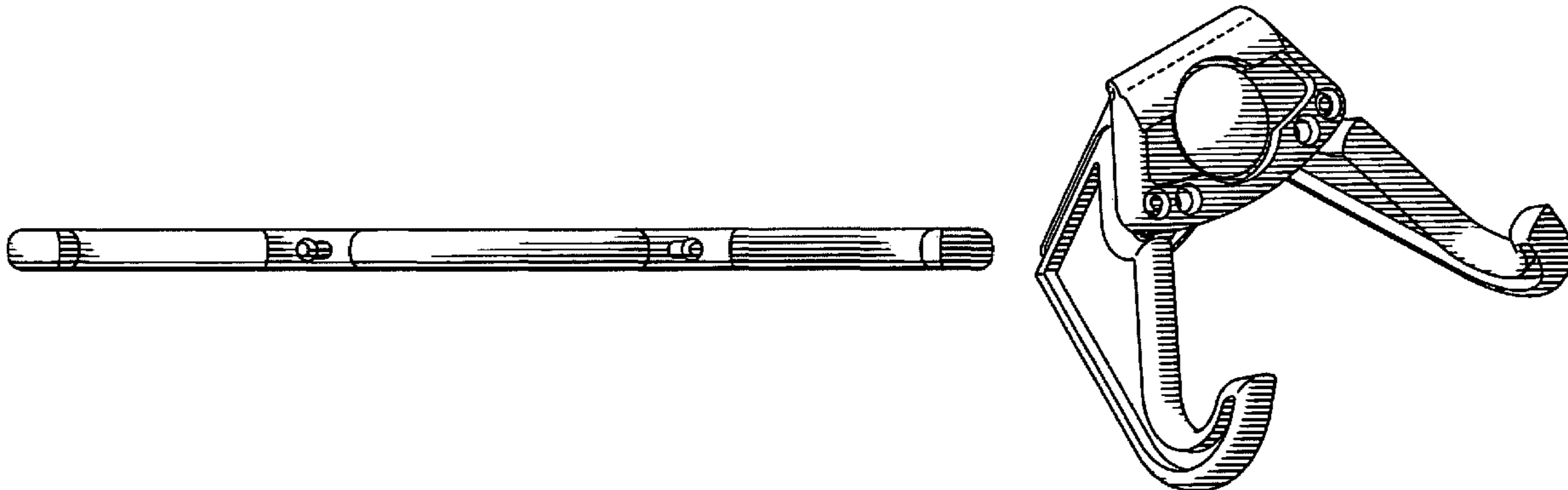

US D610,587 S

Page 2

U.S. PATENT DOCUMENTS

D439,908 S	4/2001	Gozani		D552,598 S	10/2007	Bart	
D440,542 S	4/2001	Hawkins et al.		D557,329 S *	12/2007	Lippert	D17/20
D457,351 S	5/2002	Zerman		D558,771 S *	1/2008	Derry et al.	D14/447
D457,527 S	5/2002	Manuel et al.		D558,772 S *	1/2008	Derry et al.	D14/447
6,508,451 B1	1/2003	Blythe et al.		D558,774 S *	1/2008	Najima	D14/447
D470,149 S *	2/2003	West	D14/447	D559,845 S	1/2008	Lum	
D482,904 S *	12/2003	Slaymaker	D6/466	D575,293 S *	8/2008	Derry et al.	D14/447
D495,336 S	8/2004	Andre et al.		2004/0003520 A1	1/2004	Trew	
D495,337 S	8/2004	Zerman et al.		2007/0075210 A1	4/2007	Yang	
D511,427 S *	11/2005	Meuniot et al.	D6/468	2007/0286410 A1	12/2007	Daly	
6,981,682 B2	1/2006	Kind		2008/0006745 A1	1/2008	Chong	

* cited by examiner

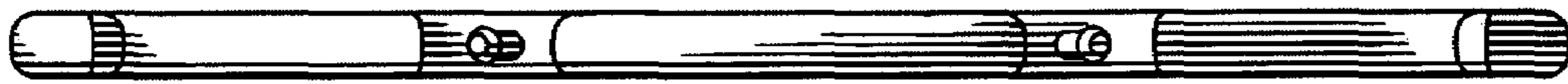

FIG. 1

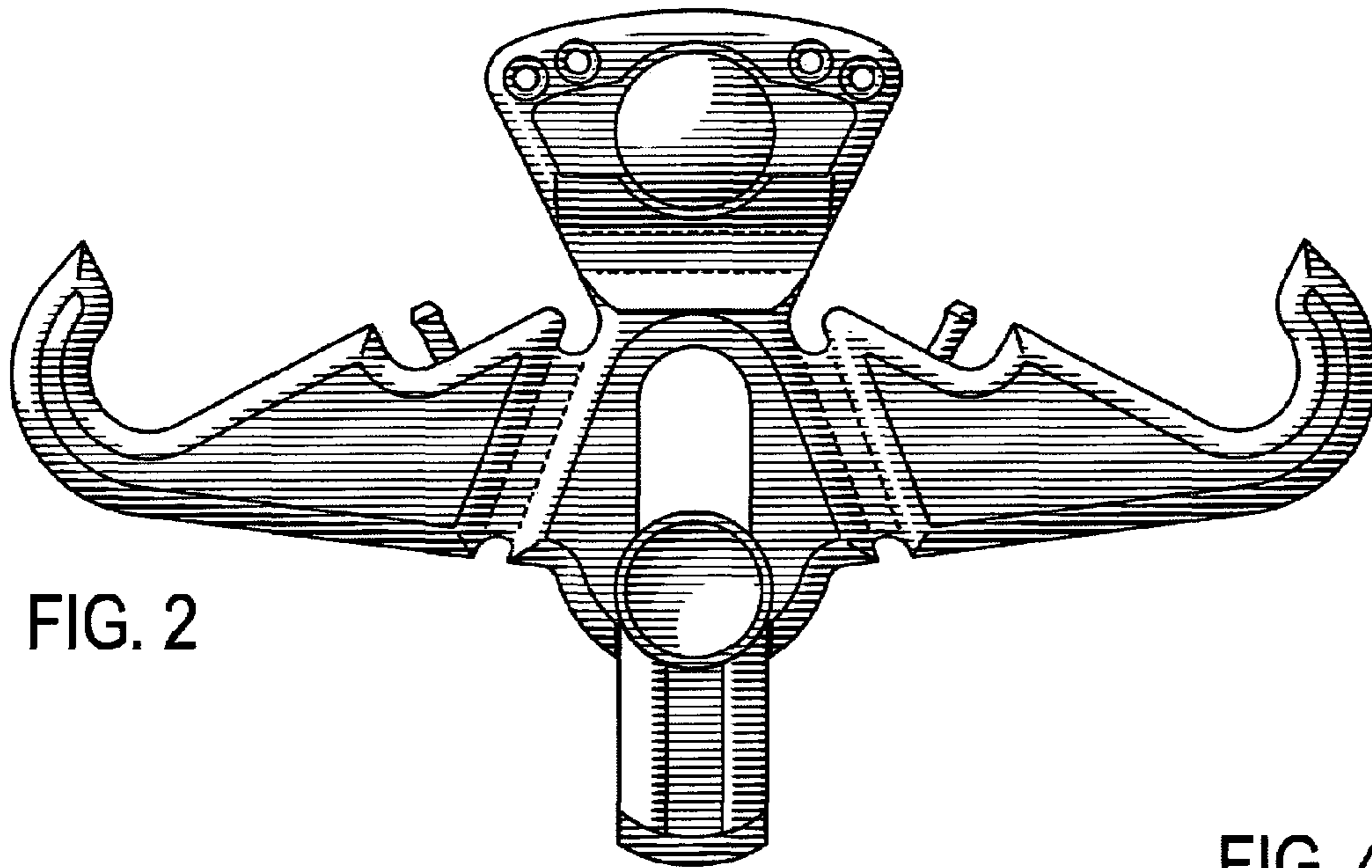

FIG. 2

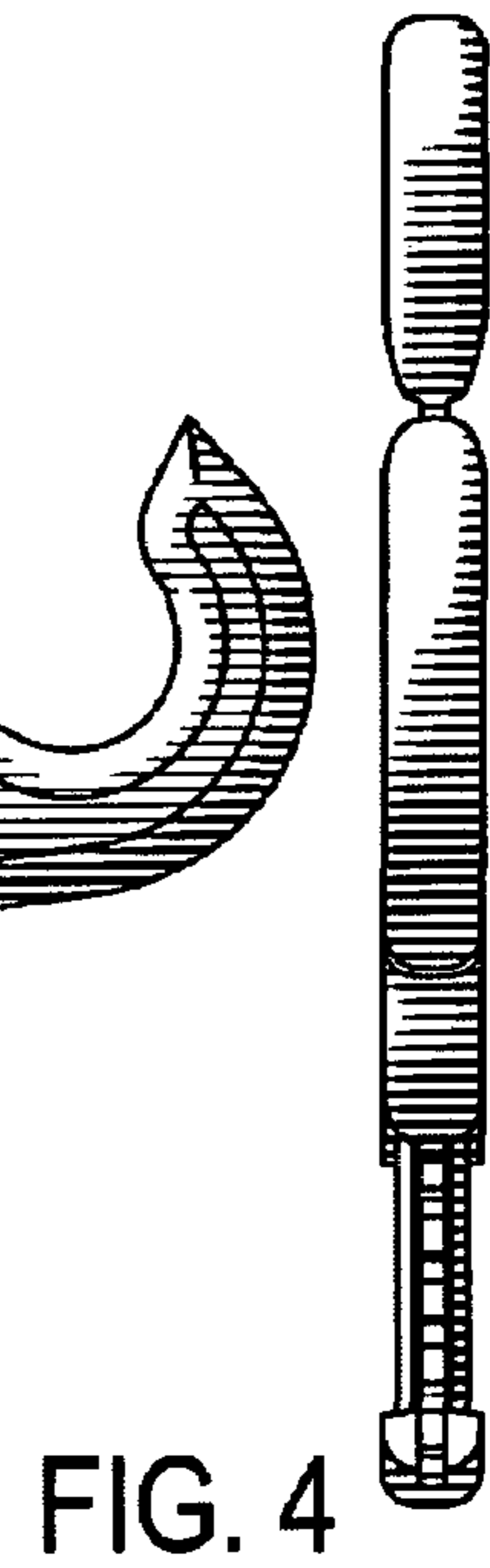

FIG. 4

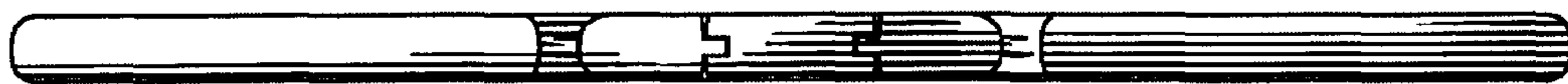

FIG. 3

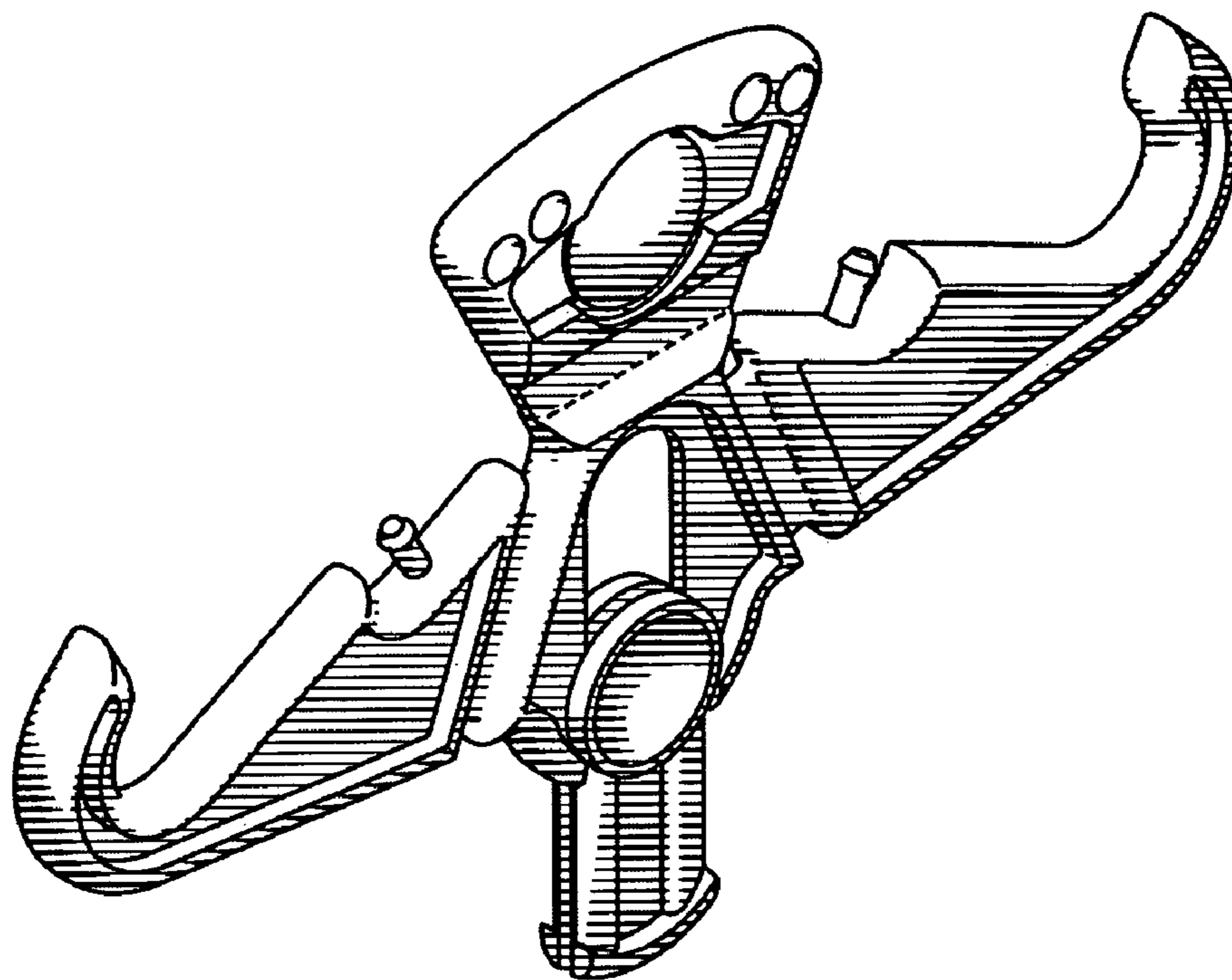

FIG. 5

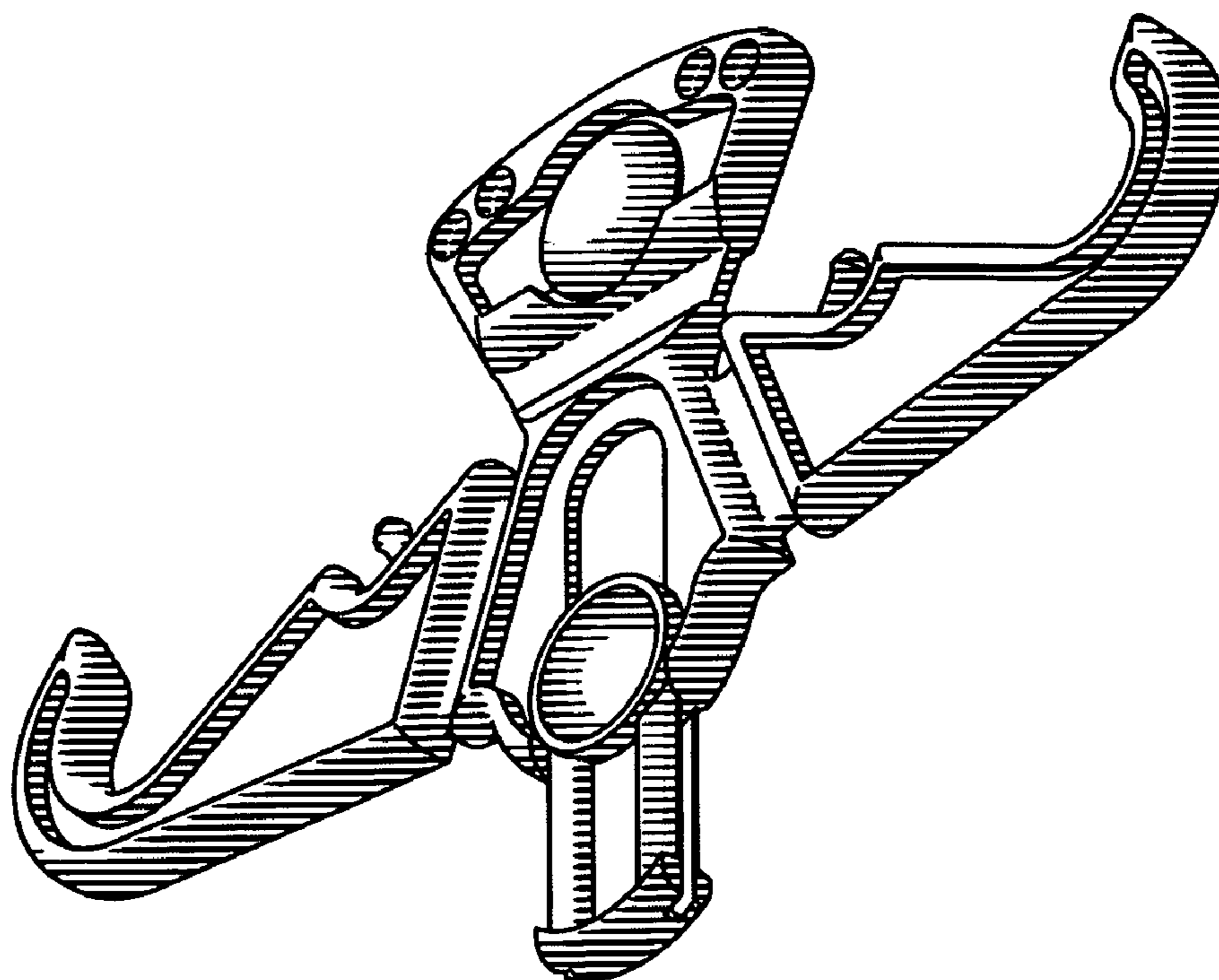

FIG. 6

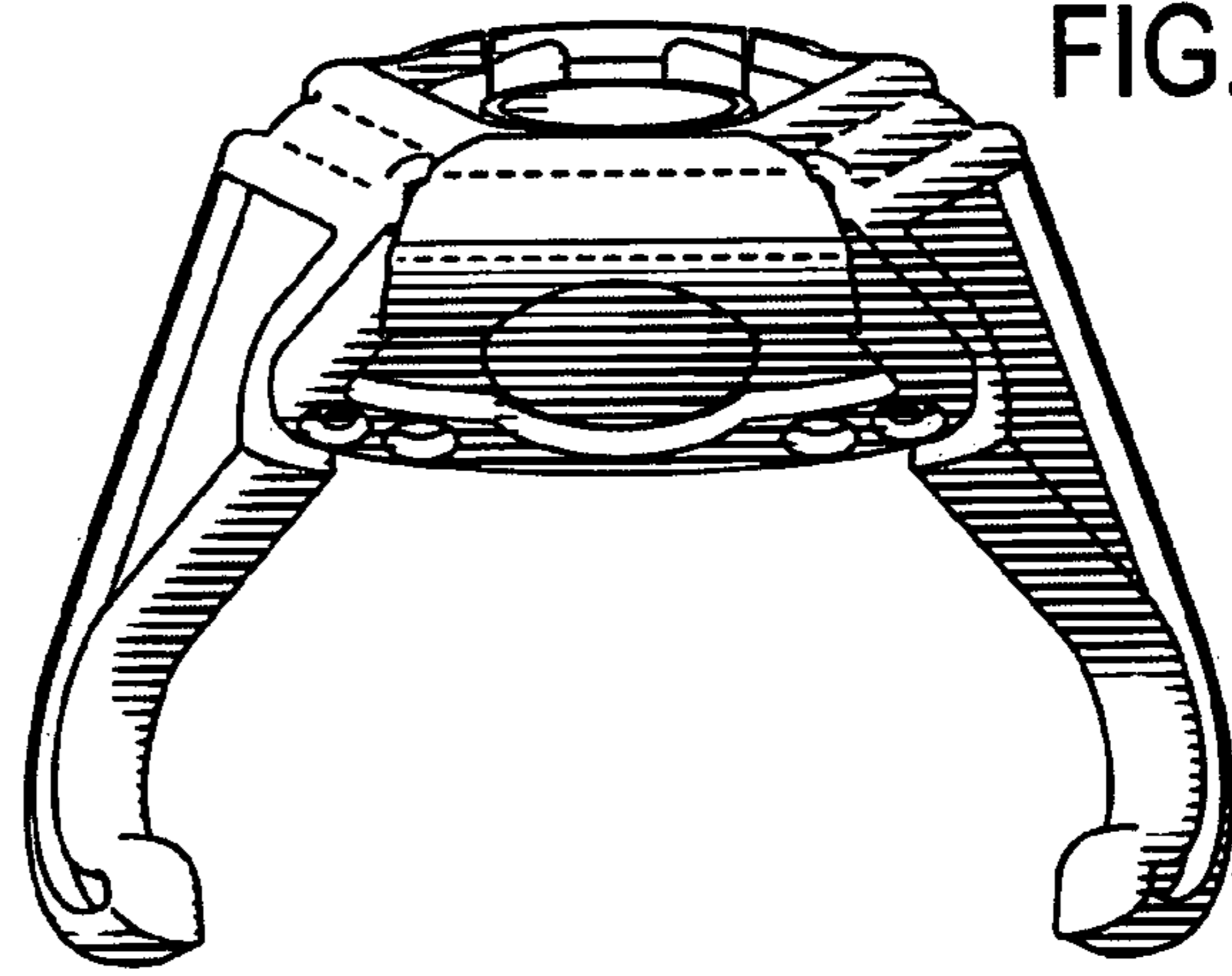

FIG. 8

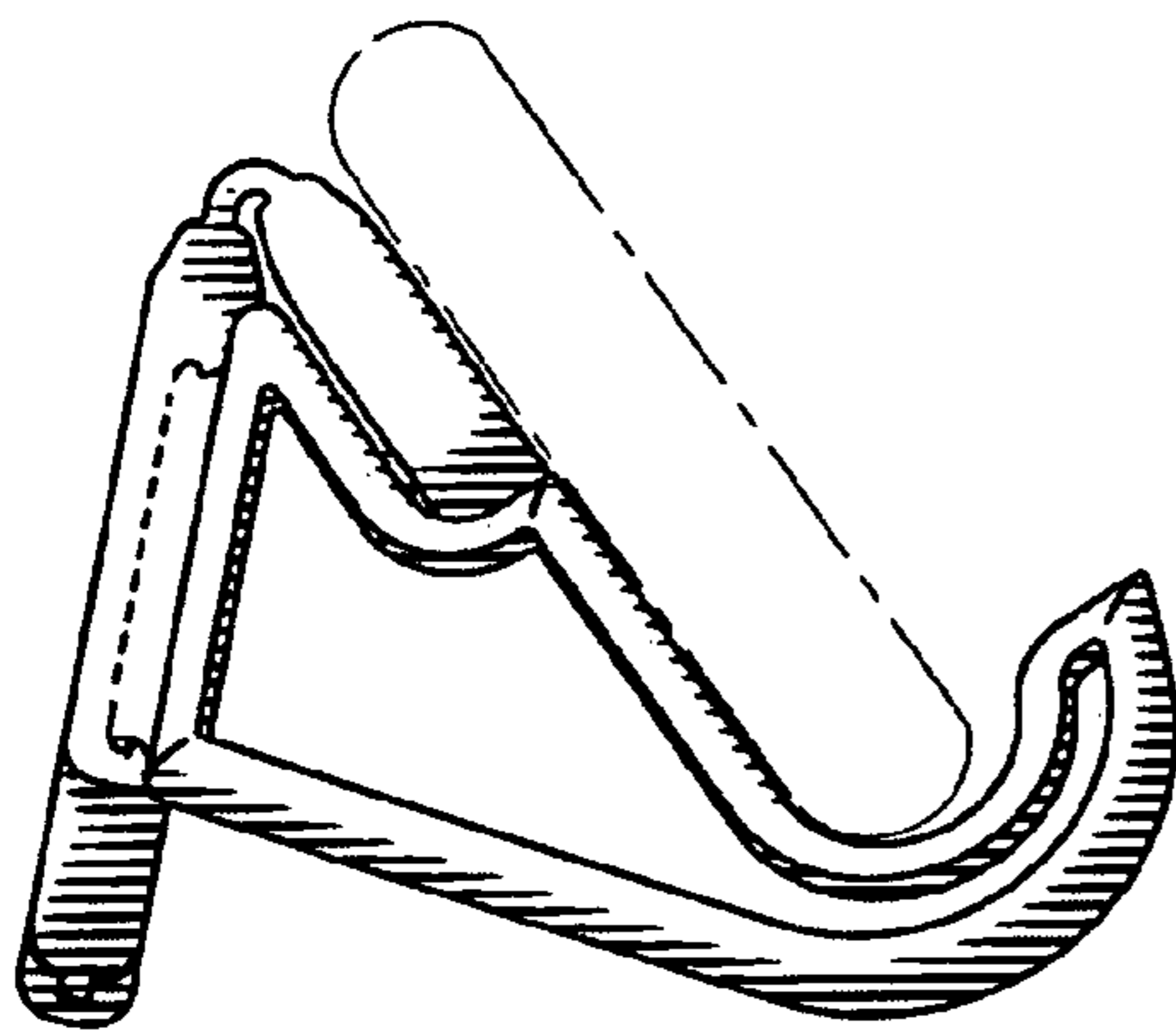

FIG. 7

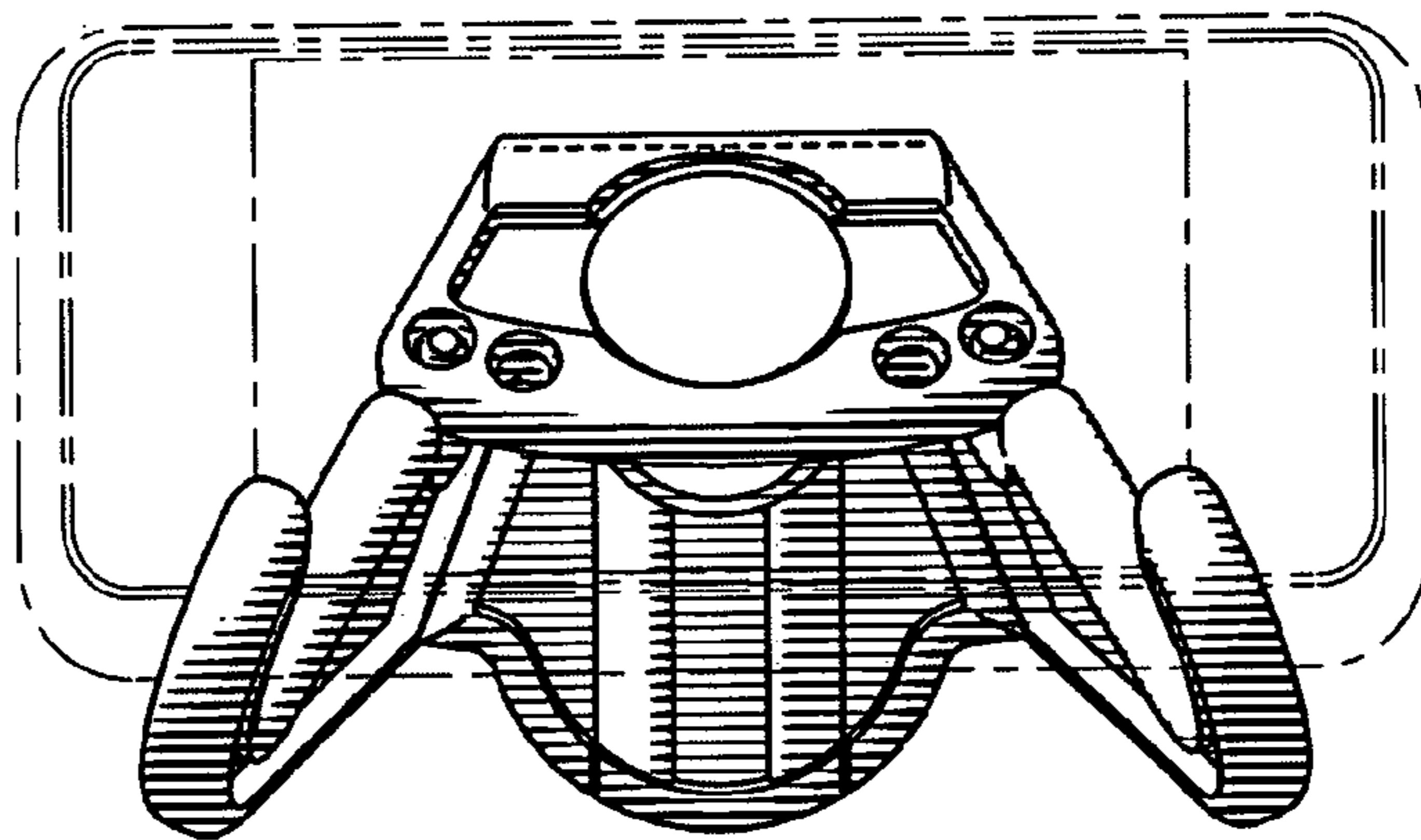

FIG. 9

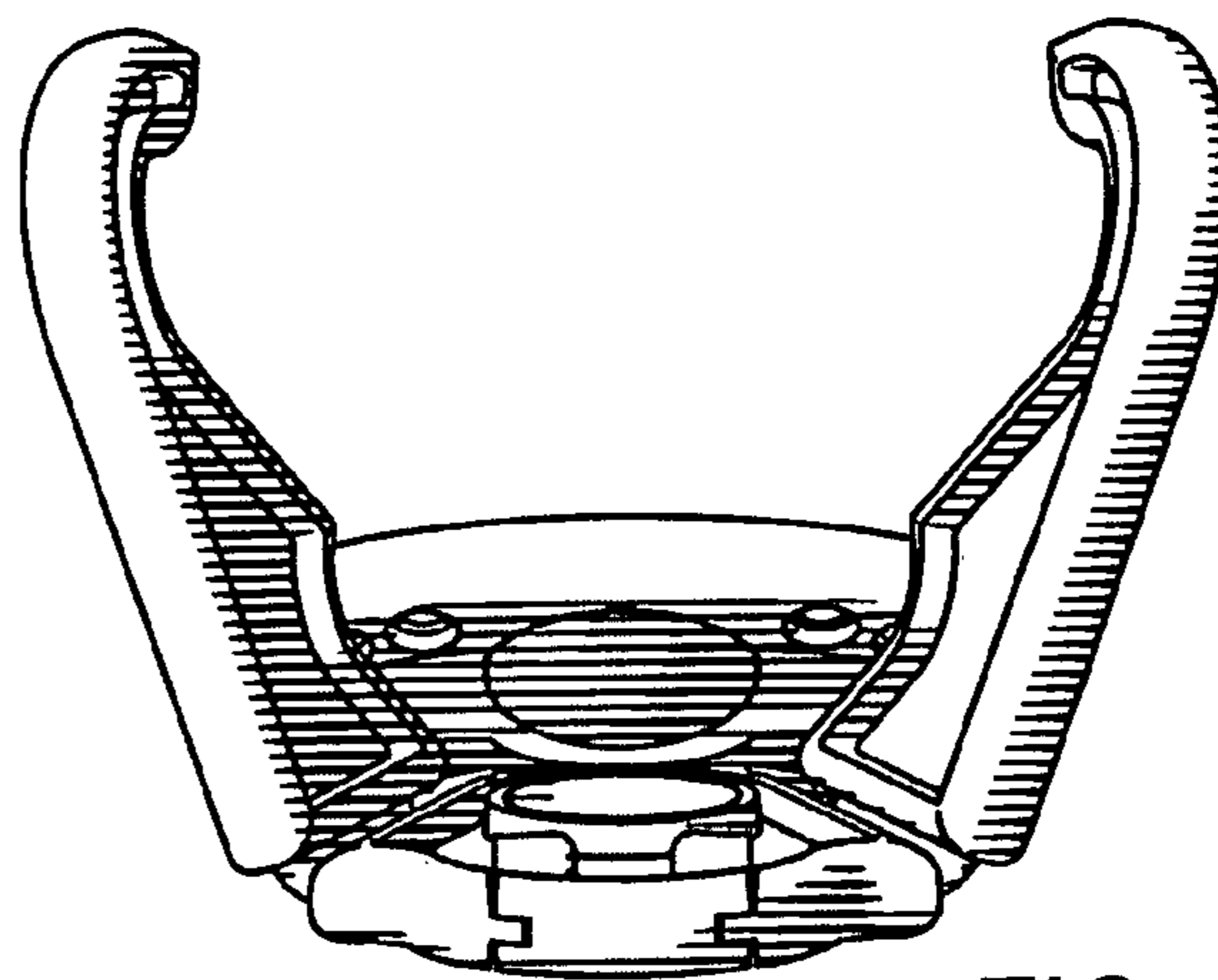

FIG. 10

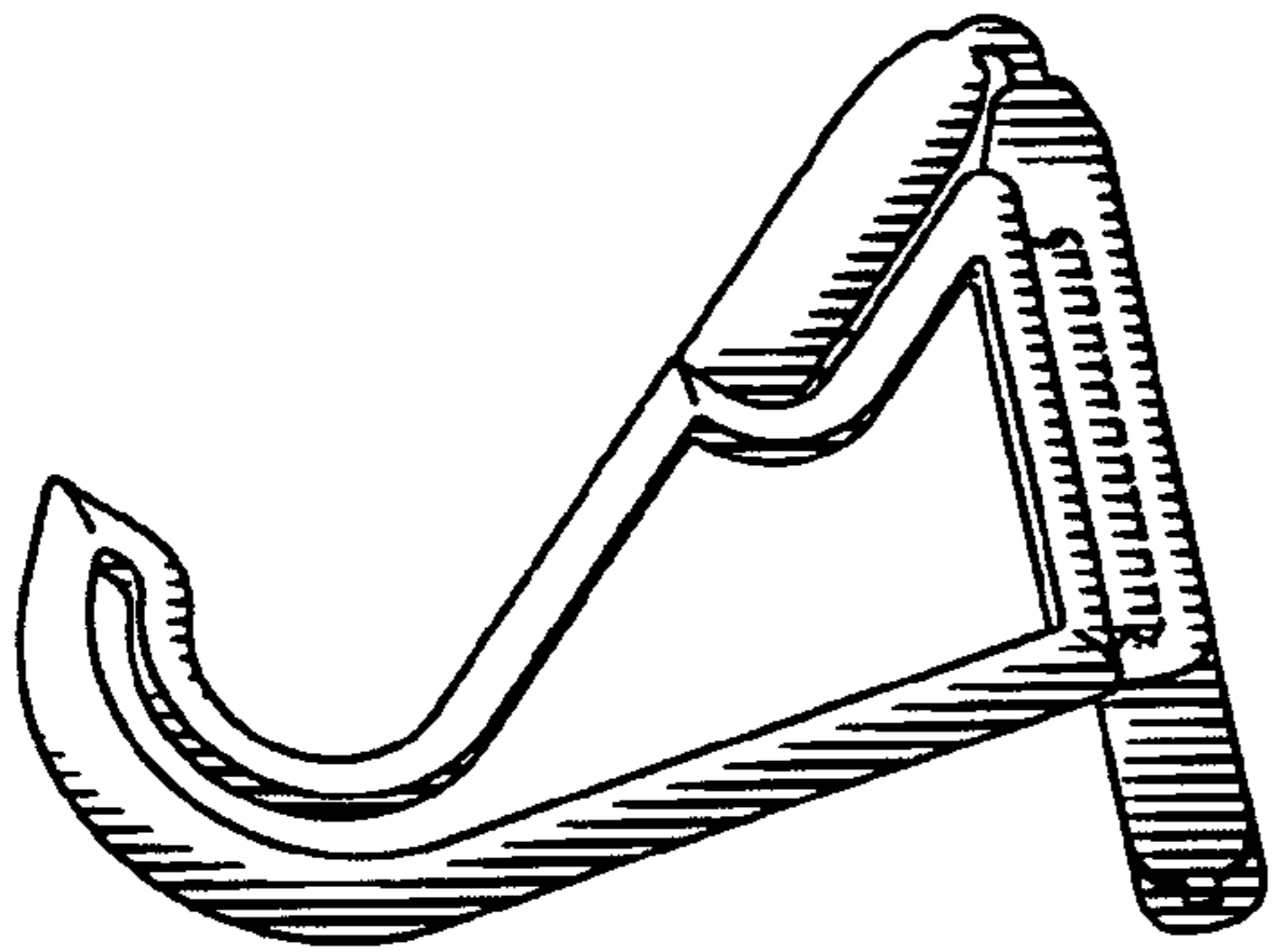

FIG. 11

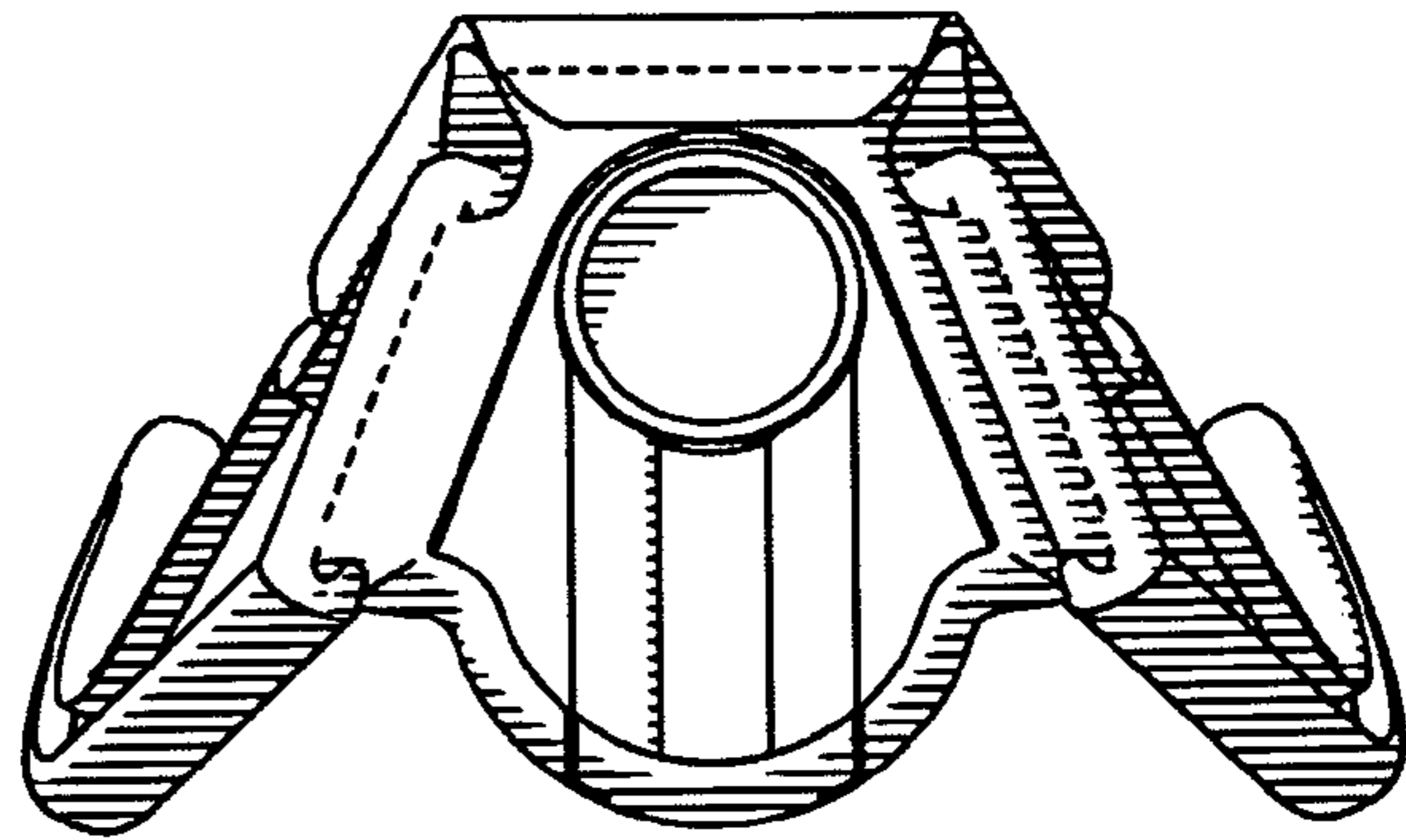

FIG. 12

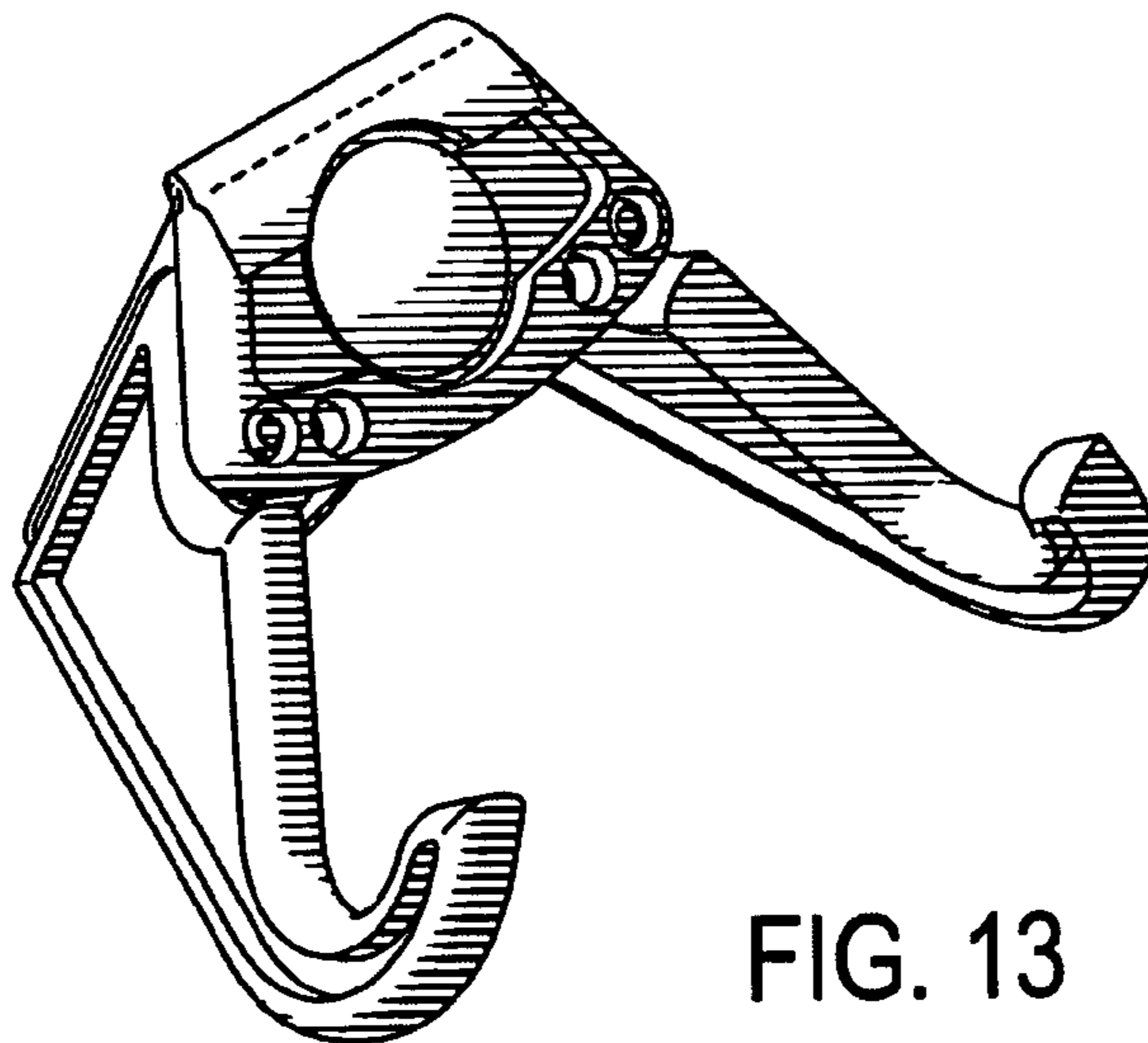

FIG. 13

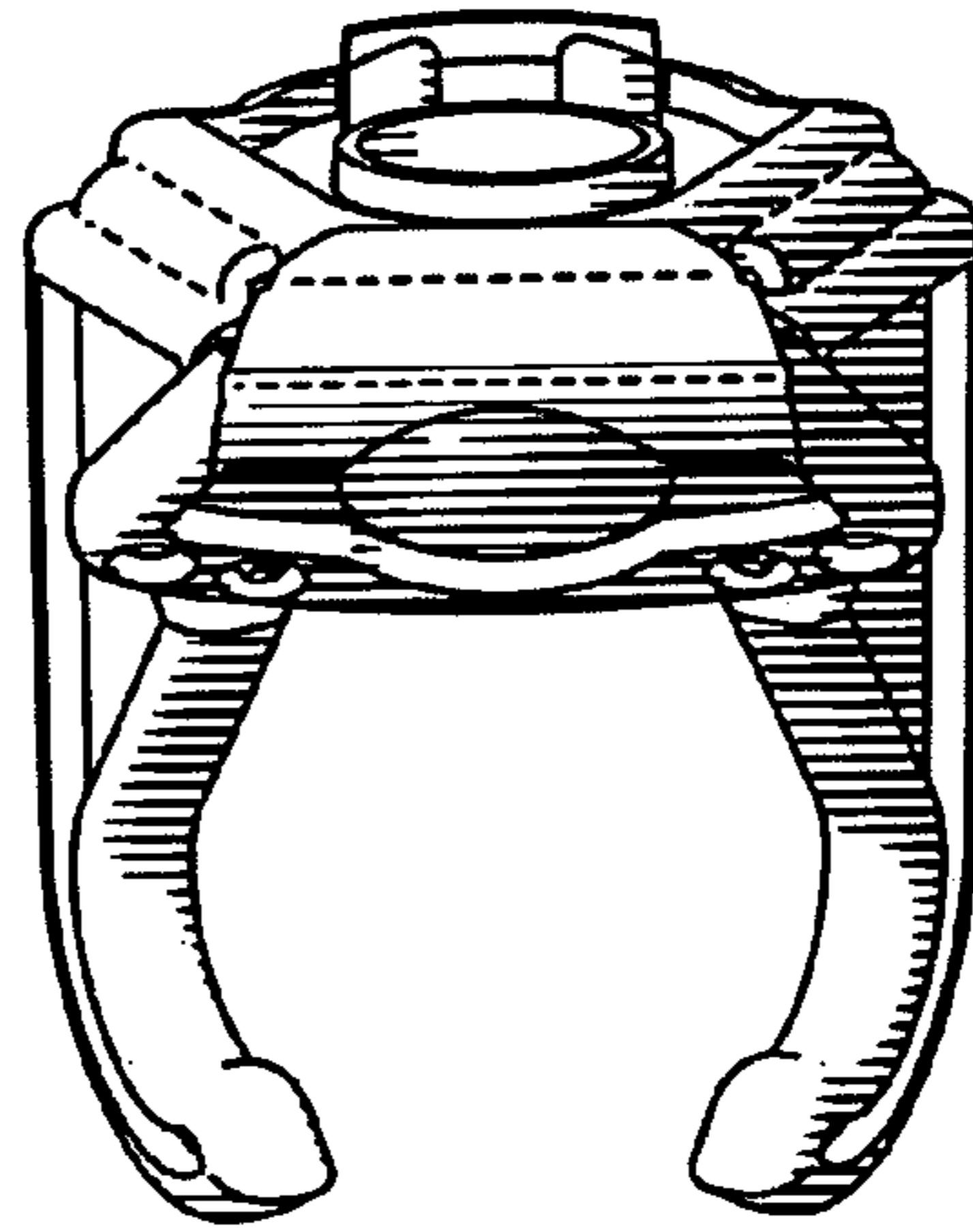

FIG. 15

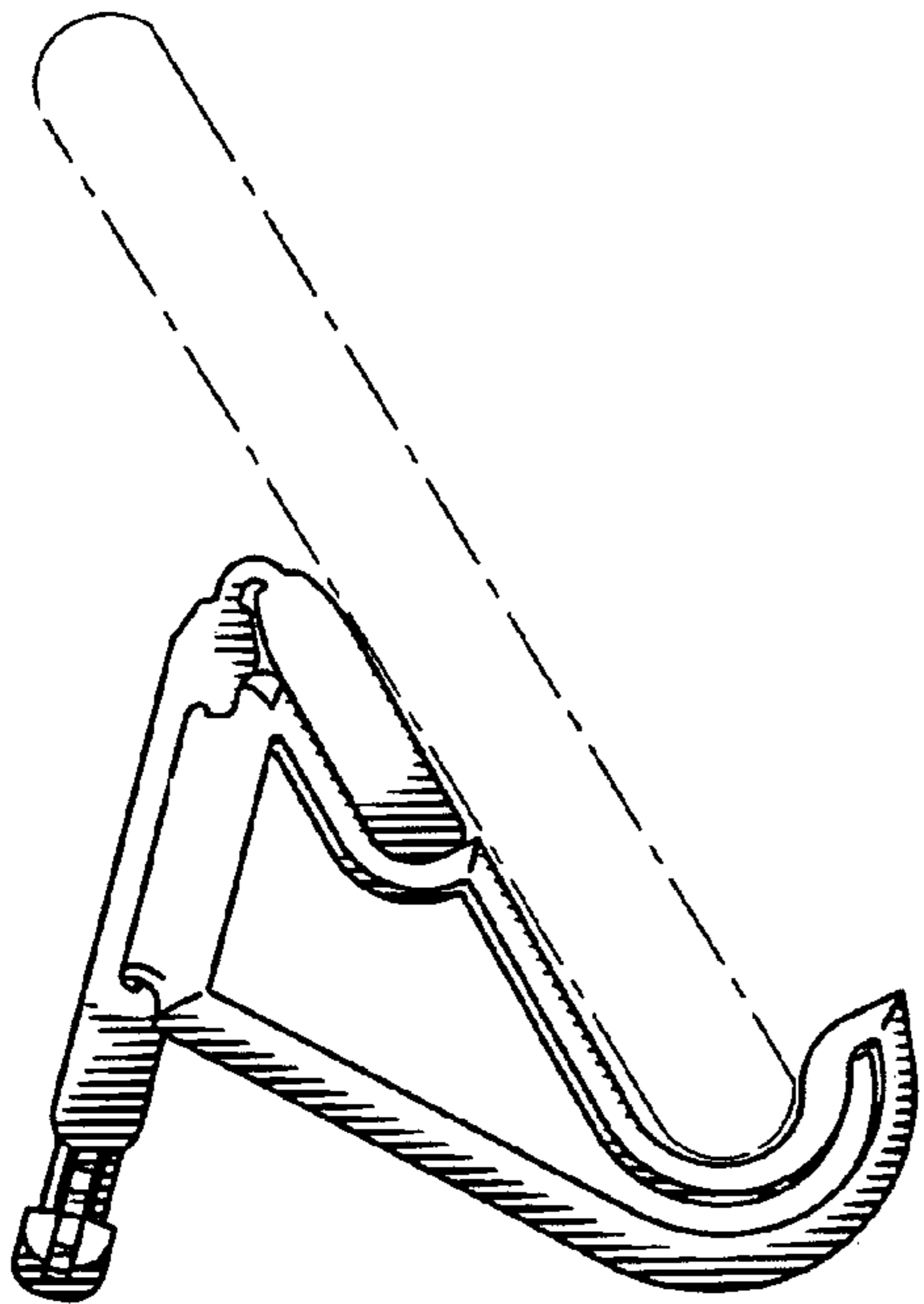

FIG. 14

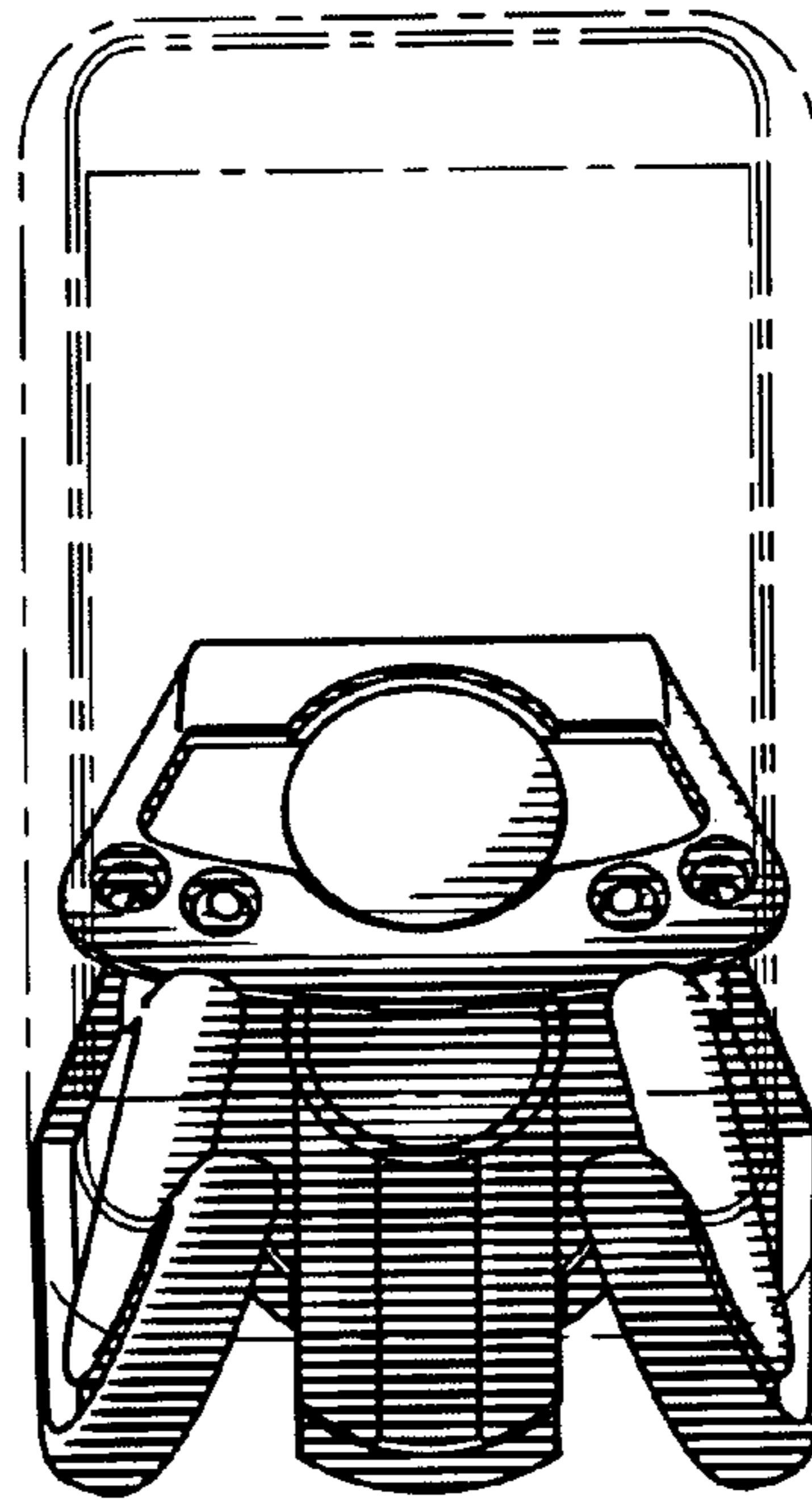

FIG. 16

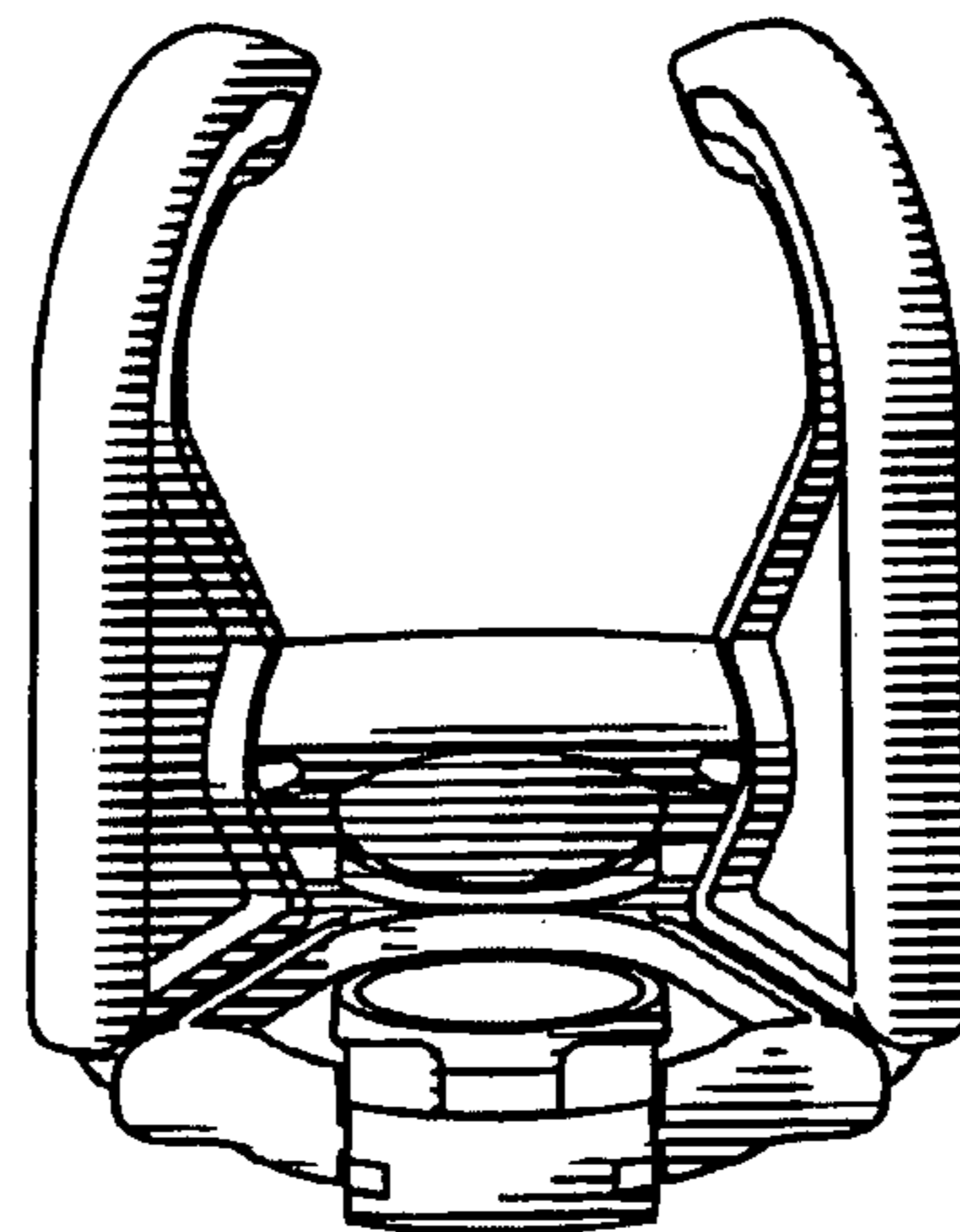

FIG. 17

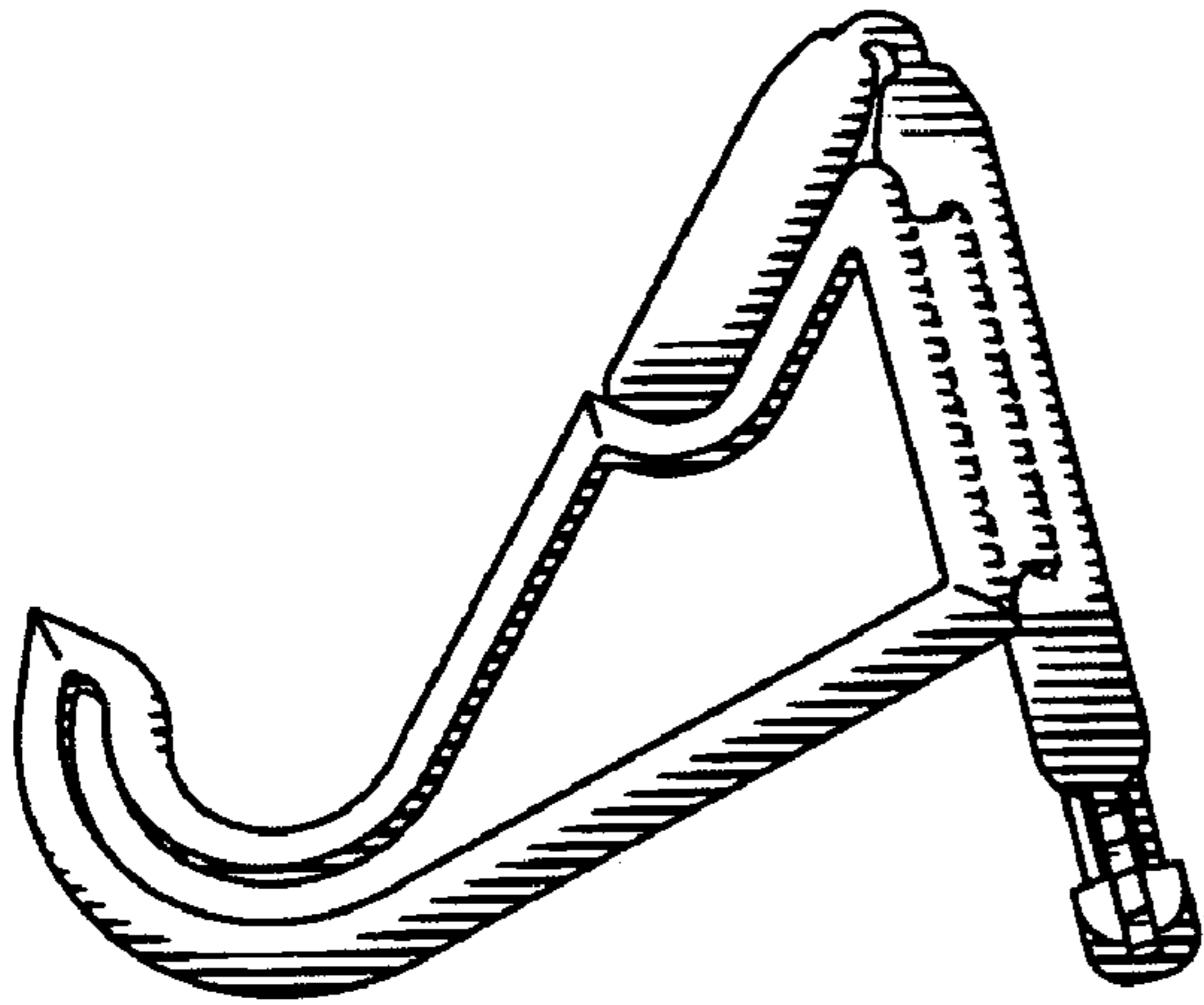

FIG. 18

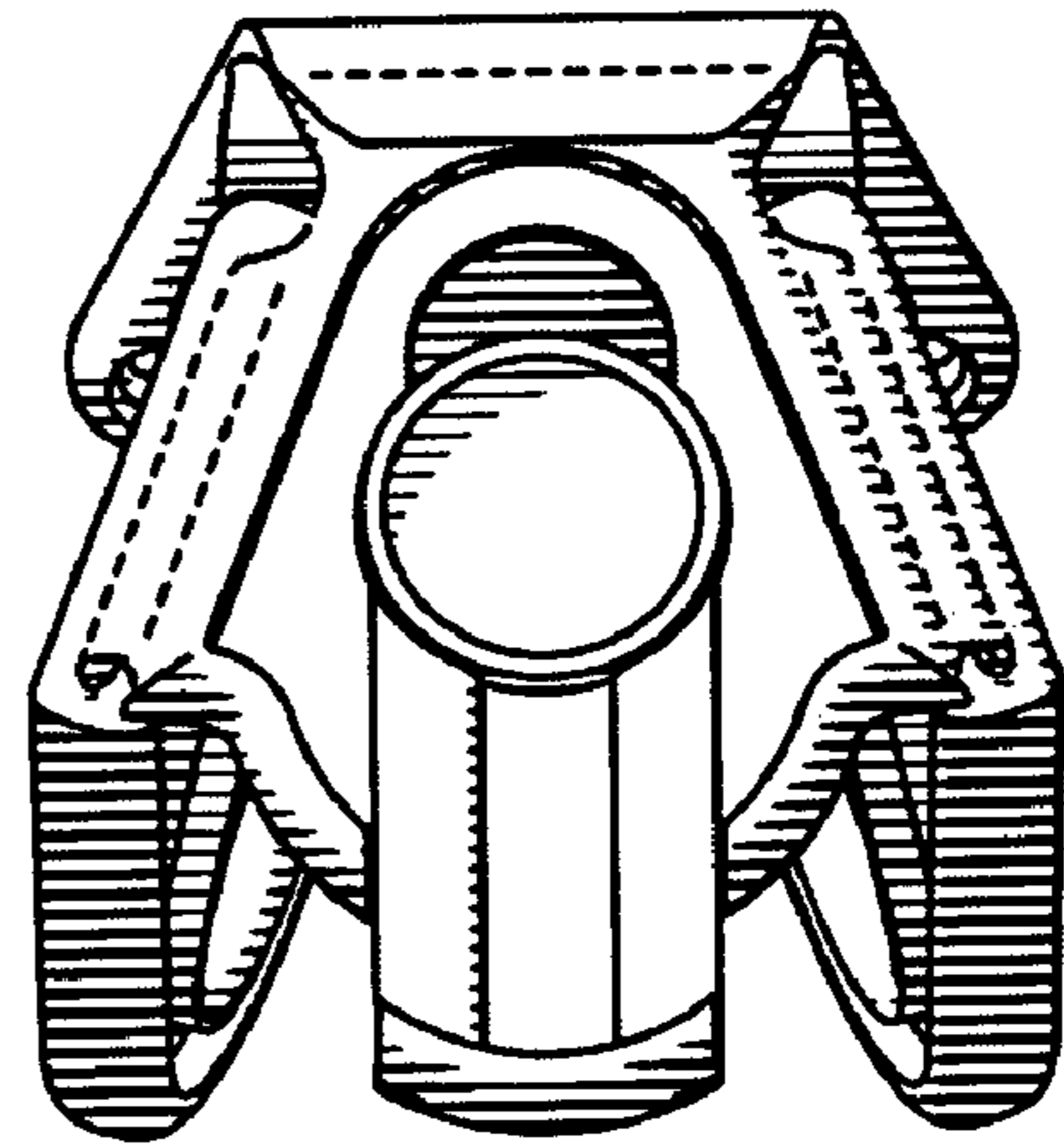

FIG. 19

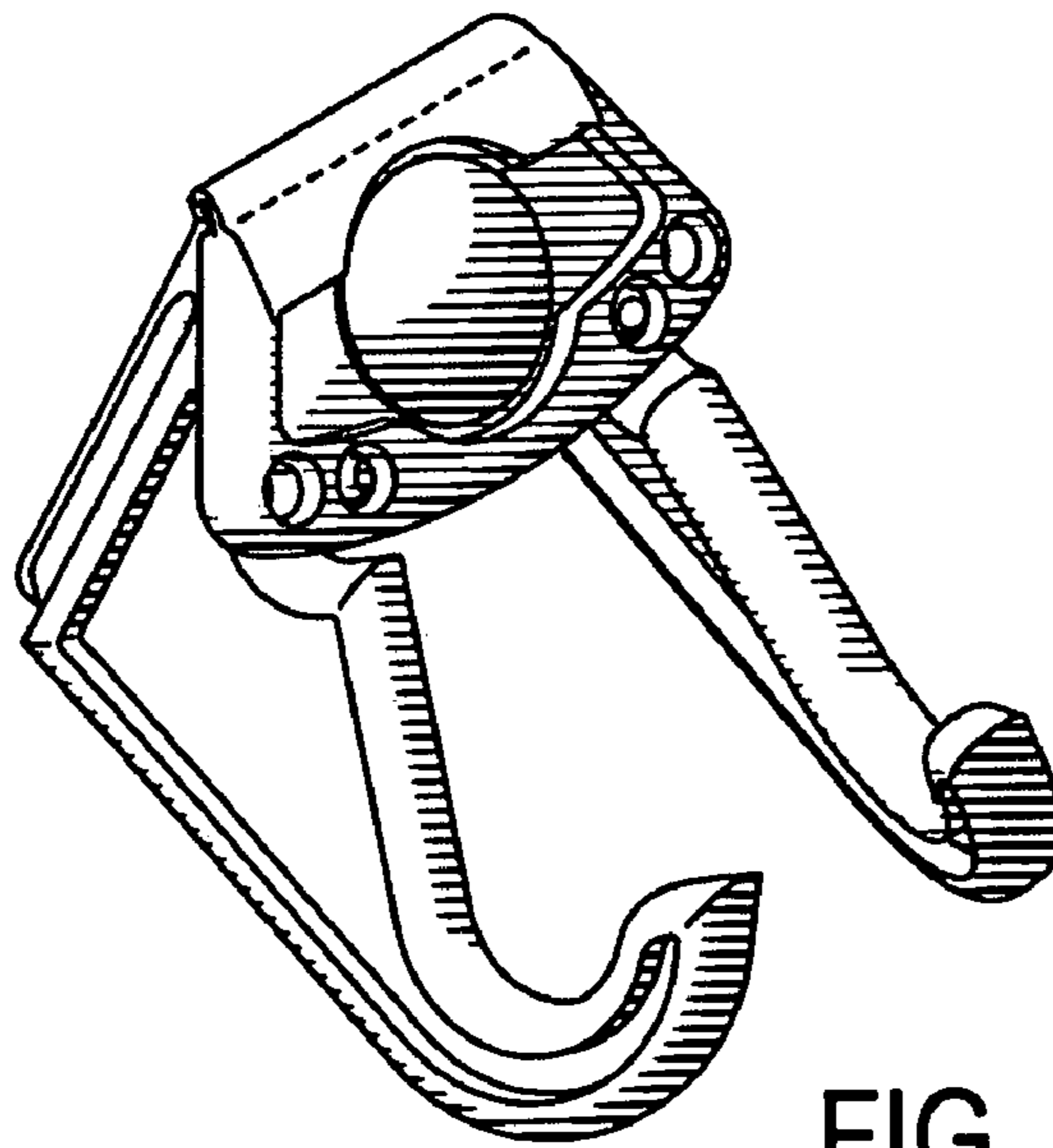

FIG. 20