



US00D610450S

(12) **United States Design Patent**
Lessard

(10) **Patent No.:** **US D610,450 S**

(45) **Date of Patent:** **** Feb. 23, 2010**

(54) **PACKAGING CONTAINER**

(75) Inventor: **Gerald J Lessard**, Coralville, IA (US)

(73) Assignee: **West Liberty Foods**, West Liberty, IA (US)

(**) Term: **14 Years**

(21) Appl. No.: **29/331,623**

(22) Filed: **Jan. 29, 2009**

(51) **LOC (9) Cl.** **09-03**

(52) **U.S. Cl.** **D9/425**

(58) **Field of Classification Search** D9/414-416, D9/418-420, 423-428, 430-432, 434, 435; D7/354, 392.1, 394, 396.1, 538, 543-545, D7/550.1, 551, 554.3, 587, 566, 575, 584, D7/586, 629, 667; 220/4.21-4.24, 293, 574, 220/602-608, 659, 675, 781-782, 793, 835, 220/839; 206/119, 467, 470, 508, 521.1, 206/545, 806; 229/406; 219/725, 728, 732, 219/735; D23/359; D3/302, 314

See application file for complete search history.

(56) **References Cited**

U.S. PATENT DOCUMENTS

D322,403 S * 12/1991 Eaton D9/429
D334,536 S * 4/1993 Long et al. D9/425
5,747,084 A * 5/1998 Cochran et al. 426/120
6,068,864 A * 5/2000 Barrett et al. 426/20

D450,240 S * 11/2001 Haag et al. D9/416
D474,687 S * 5/2003 Jones et al. D9/761
D482,277 S * 11/2003 Castellanos et al. D9/425
D522,355 S * 6/2006 Castellanos et al. D9/425
7,172,779 B2 * 2/2007 Castellanos et al. 426/106

* cited by examiner

Primary Examiner—Philip S Hyder

Assistant Examiner—Susan E Krakower

(74) *Attorney, Agent, or Firm*—Emily E. Harris; Kent A. Herink

(57) **CLAIM**

The ornamental design for a packaging container, as shown and described.

DESCRIPTION

FIG. 1 is a top perspective view of the packaging container.
FIG. 2 is a first end view of the packaging container.
FIG. 3 is a second end view of the packaging container, opposite of the end view of FIG. 2.
FIG. 4 is a first side view the packaging container, opposite of the side view of FIG. 2.
FIG. 5 is a second side view of the packaging container, opposite of the side view of FIG. 4.
FIG. 6 is a top view of the packaging container; and,
FIG. 7 is a bottom view of the packaging container.

1 Claim, 2 Drawing Sheets

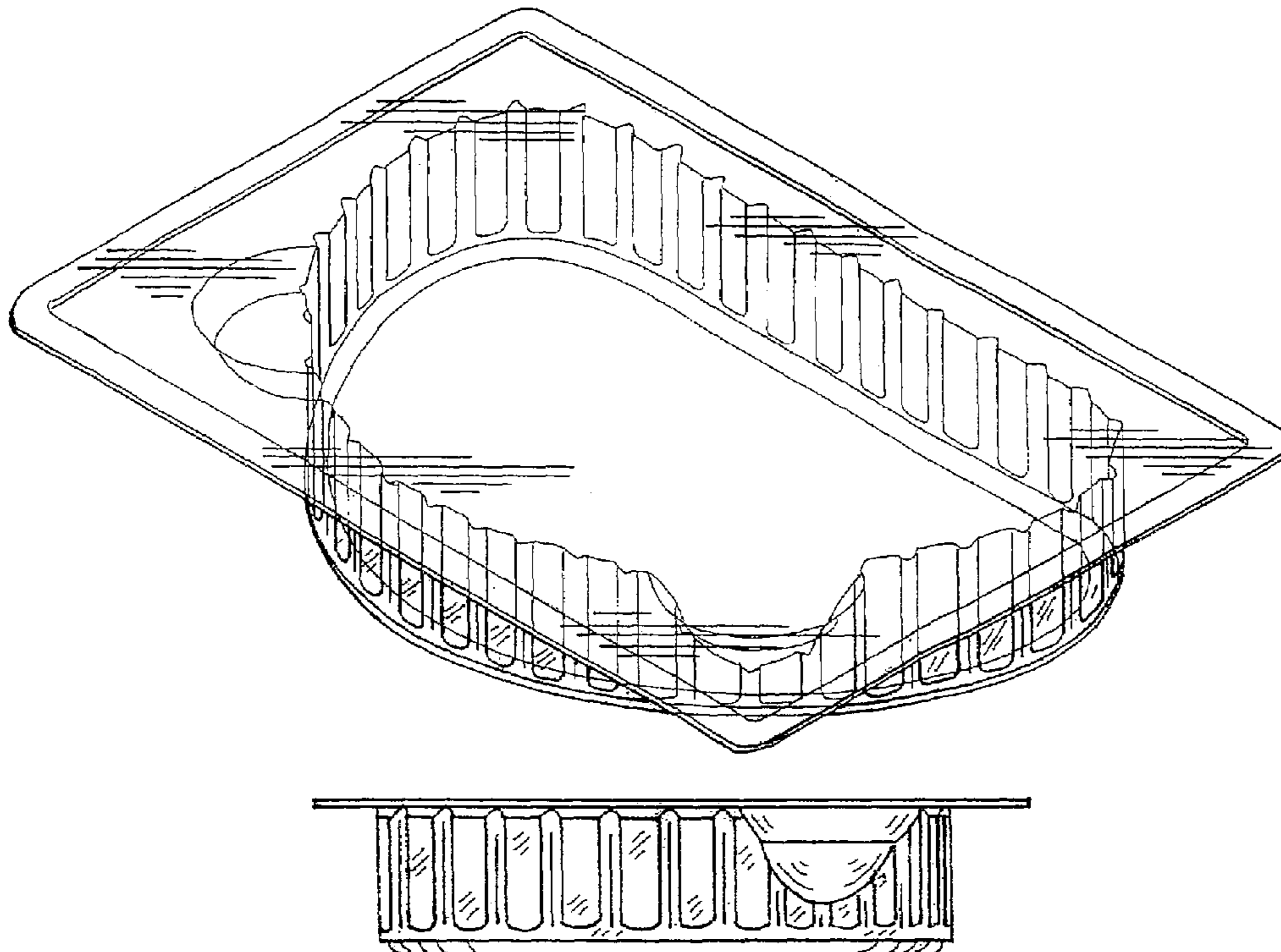

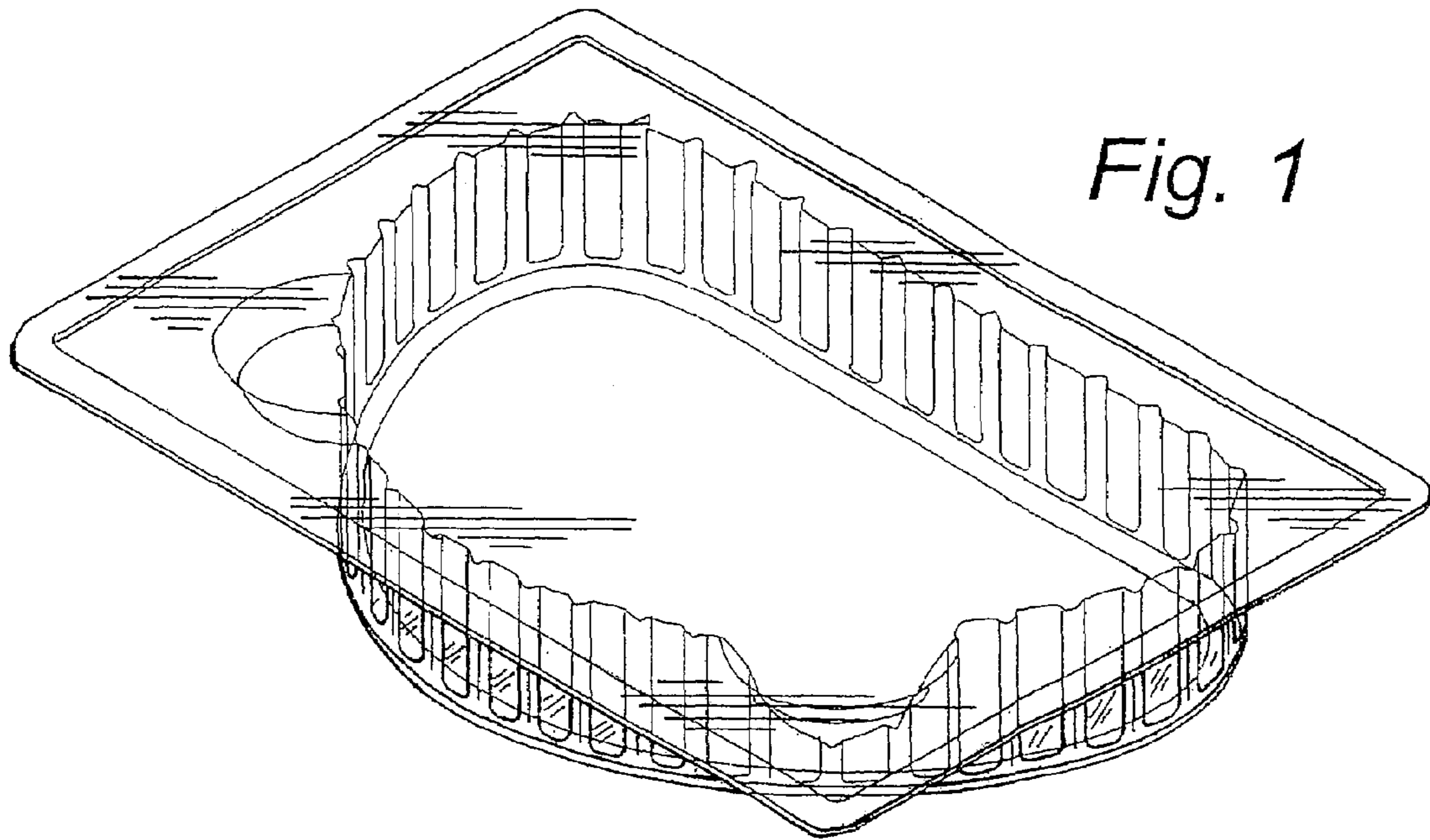

Fig. 1

Fig. 2

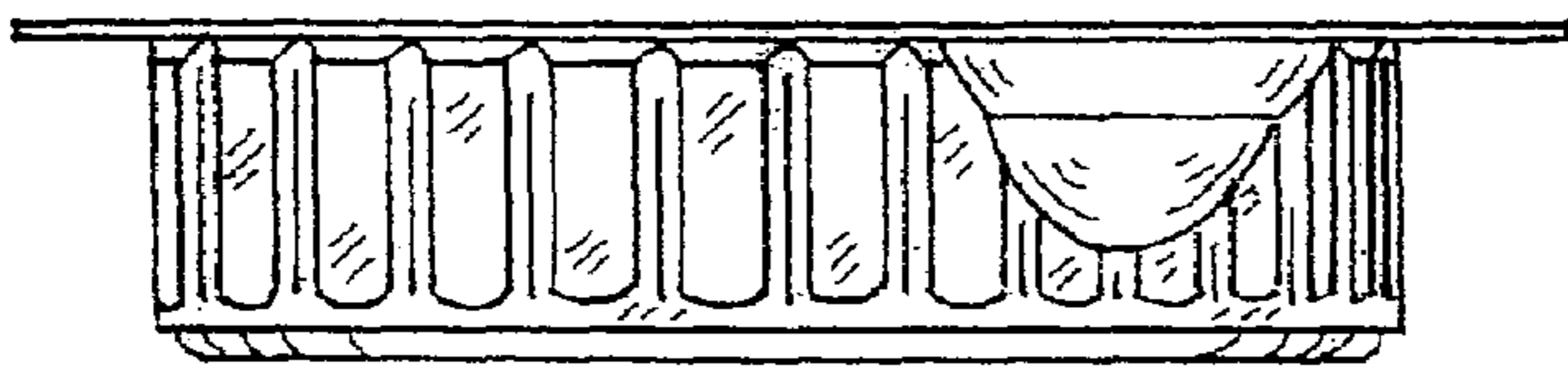

Fig. 3

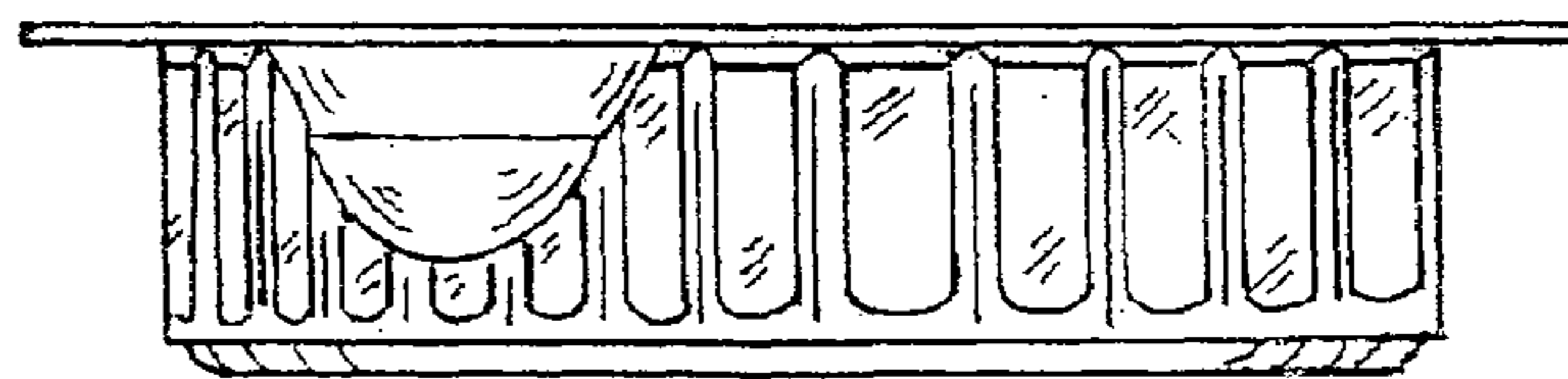

Fig. 4

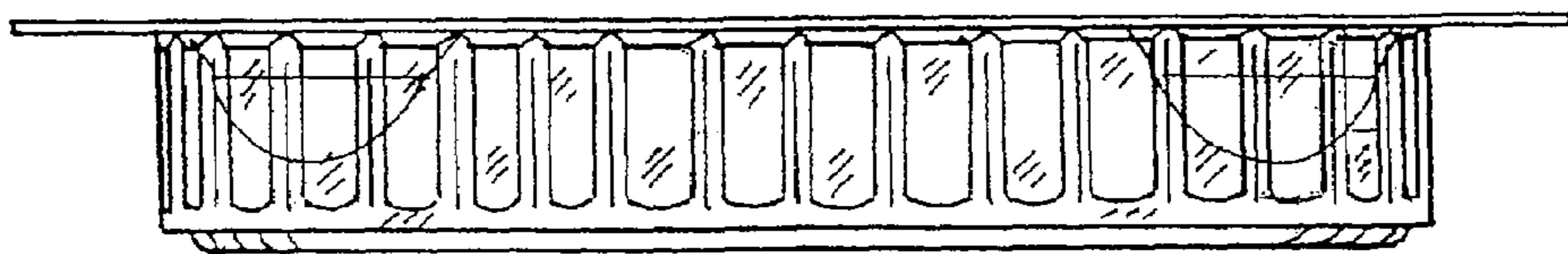
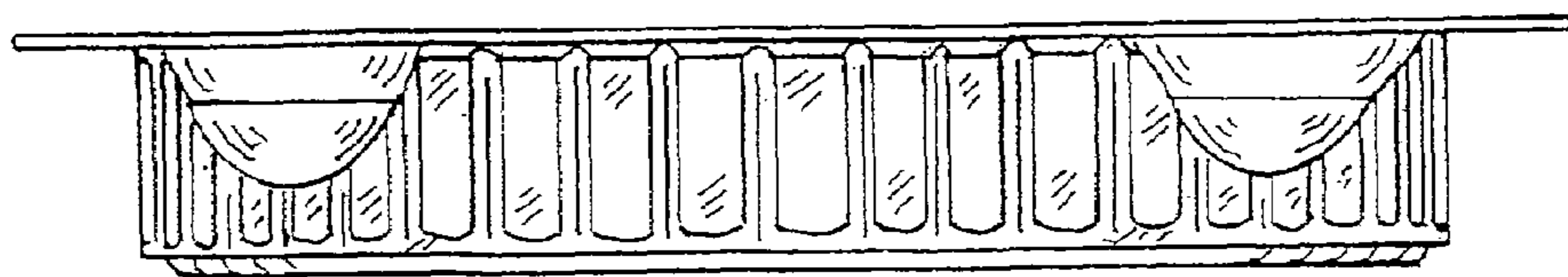

Fig. 5



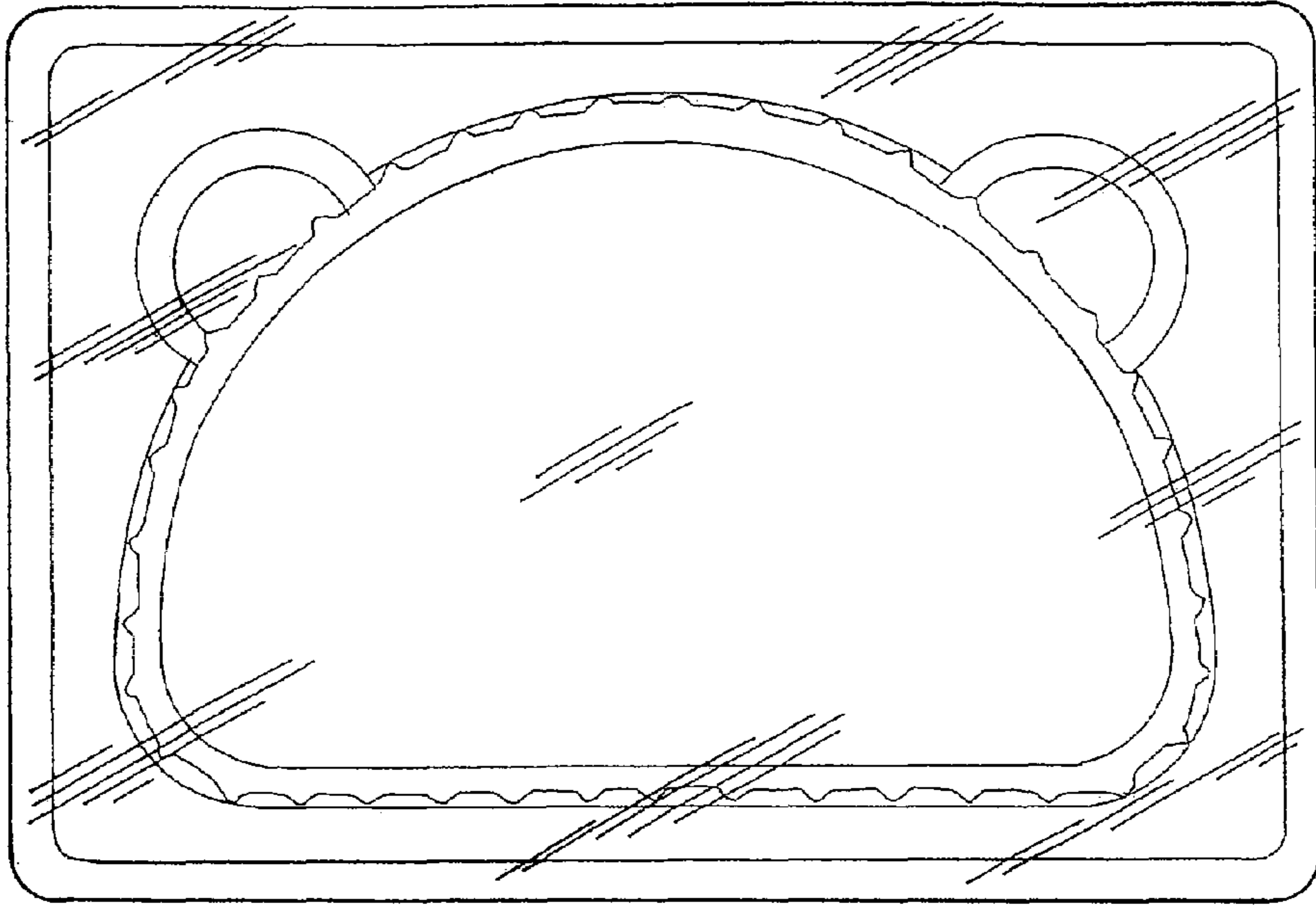

Fig. 6

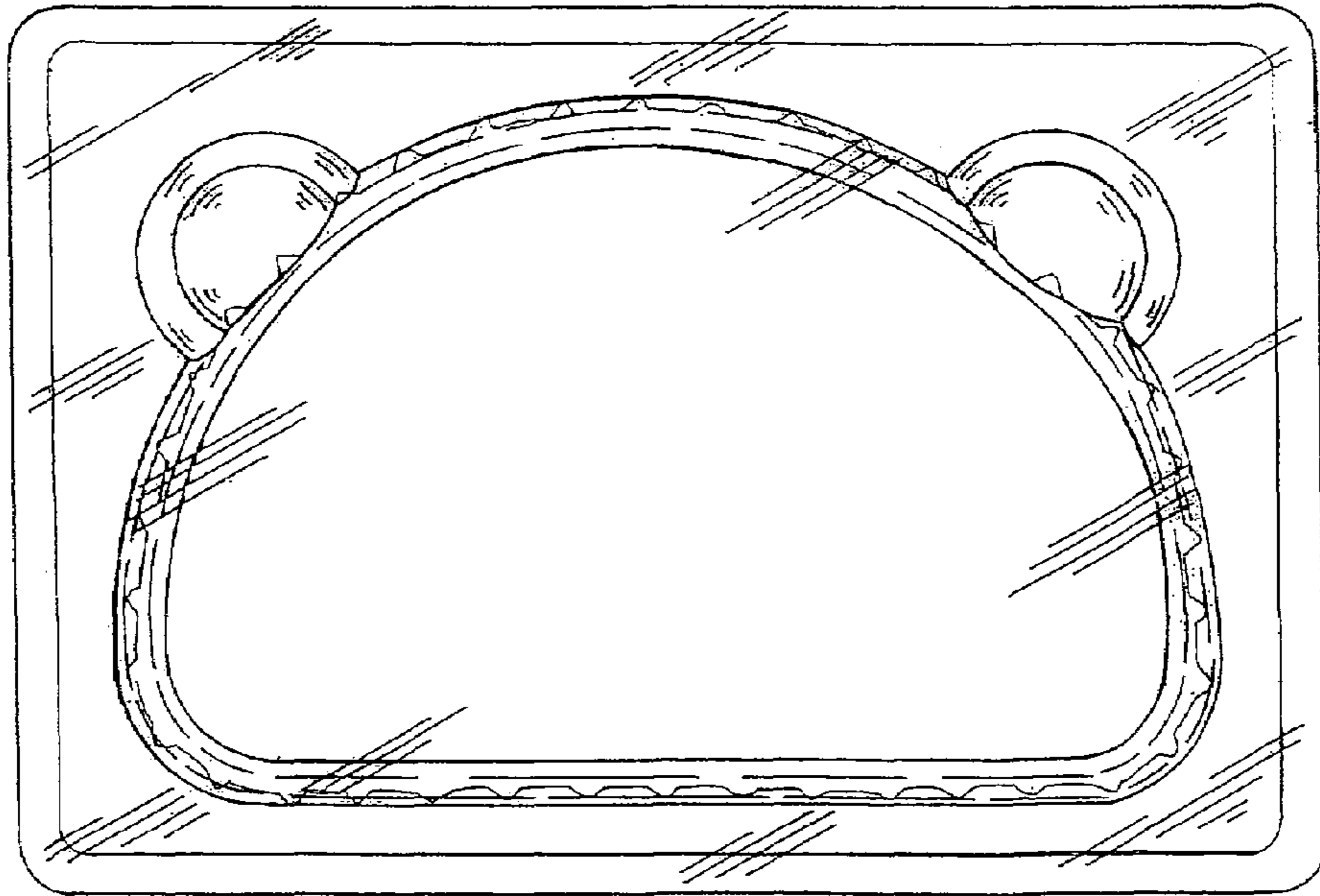

Fig. 7