



US00D610374S

(12) **United States Design Patent**
Matus, Jr.

(10) **Patent No.:** **US D610,374 S**

(45) **Date of Patent:** **** Feb. 23, 2010**

(54) **SUPPORT POST FOR A FOOD GUARD SYSTEM**

(76) Inventor: **Jose Orlando Matus, Jr.**, 3860 Jack Wilson Rd., Gainesville, GA (US) 30506

(**) Term: **14 Years**

(21) Appl. No.: **29/326,264**

(22) Filed: **Oct. 15, 2008**

(51) **LOC (9) Cl.** **06-04**

(52) **U.S. Cl.** **D6/491**

(58) **Field of Classification Search** D6/397,
D6/471, 491, 495, 511, 470, 472, 481; 211/85.4;
312/114, 116, 137, 140.4; D8/363, 349,
D8/354, 373; D25/126

See application file for complete search history.

(56) **References Cited**

U.S. PATENT DOCUMENTS

D32,585	S *	4/1900	Pessano	D8/363
D65,500	S *	8/1924	Schmale	D7/402
D114,696	S *	5/1939	Connors	D8/373
D144,085	S *	3/1946	Van Doren	D8/381
2,834,621	A *	5/1958	Schroer	403/188
D206,198	S *	11/1966	Molitor	D6/509
D301,832	S *	6/1989	Hathaway	D8/349
D376,307	S *	12/1996	Burgasser et al.	D8/349
6,010,103	A *	1/2000	Ashworth	248/301
D420,235	S *	2/2000	Cordero	D6/512
6,056,129	A *	5/2000	Ahearn et al.	211/70.6
D427,460	S *	7/2000	McGrath	D6/491
6,101,954	A *	8/2000	Rein et al.	108/50.02
6,132,018	A *	10/2000	McGrath	312/140.4
6,485,118	B2 *	11/2002	Matus, Jr.	312/137

6,588,863	B1 *	7/2003	Yatchak et al.	312/140.4
7,040,723	B2 *	5/2006	Matus, Jr.	312/140.4
D529,788	S *	10/2006	Peters	D8/354
2006/0175940	A1 *	8/2006	English	312/137
2006/0192467	A1 *	8/2006	Matus	312/140.4
2007/0090733	A1 *	4/2007	Matus	312/140.4
2007/0236112	A1 *	10/2007	Williman	312/140.4

* cited by examiner

Primary Examiner—Janice E Seeger

Assistant Examiner—Zenia I Bennett

(74) *Attorney, Agent, or Firm*—Daniel J. Santos

(57) **CLAIM**

The ornamental design for a support post for a food guard system, as shown and described.

DESCRIPTION

FIG. 1 illustrates a perspective view of the support post secured to a food guard shield.

FIG. 2 illustrates a left-side perspective view of the support post shown in FIG. 1.

FIG. 3 illustrates a top plan view of the support post shown in FIG. 2.

FIG. 4 illustrates a side plan view of the support post shown in FIG. 2.

FIG. 5 illustrates a bottom plan view of the support post shown in FIG. 2; and,

FIG. 6 illustrates a front plan view of the support post shown in FIG. 2.

The broken lines in the drawings are for illustrative purposes only and form no part of the claimed design.

1 Claim, 6 Drawing Sheets

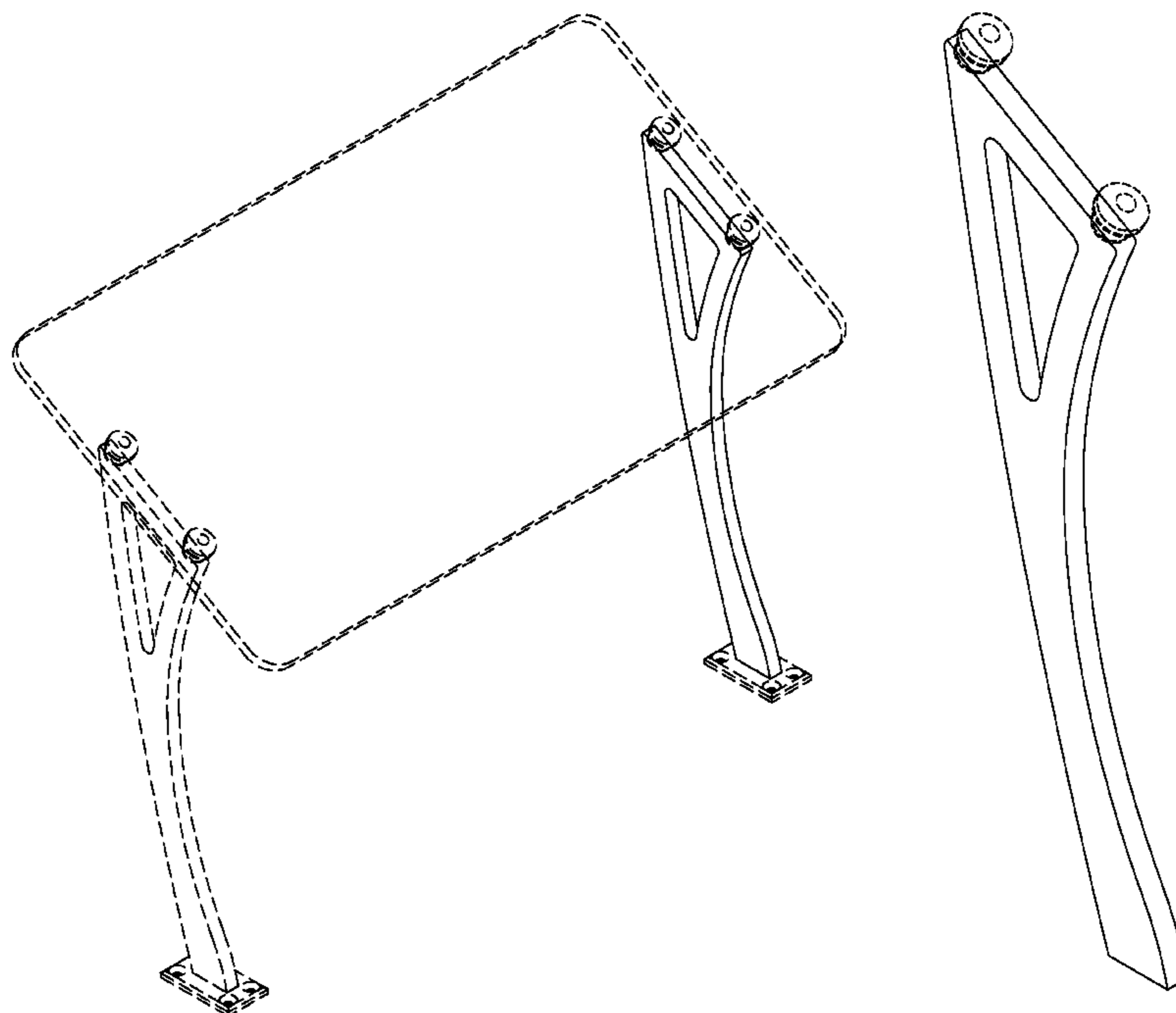

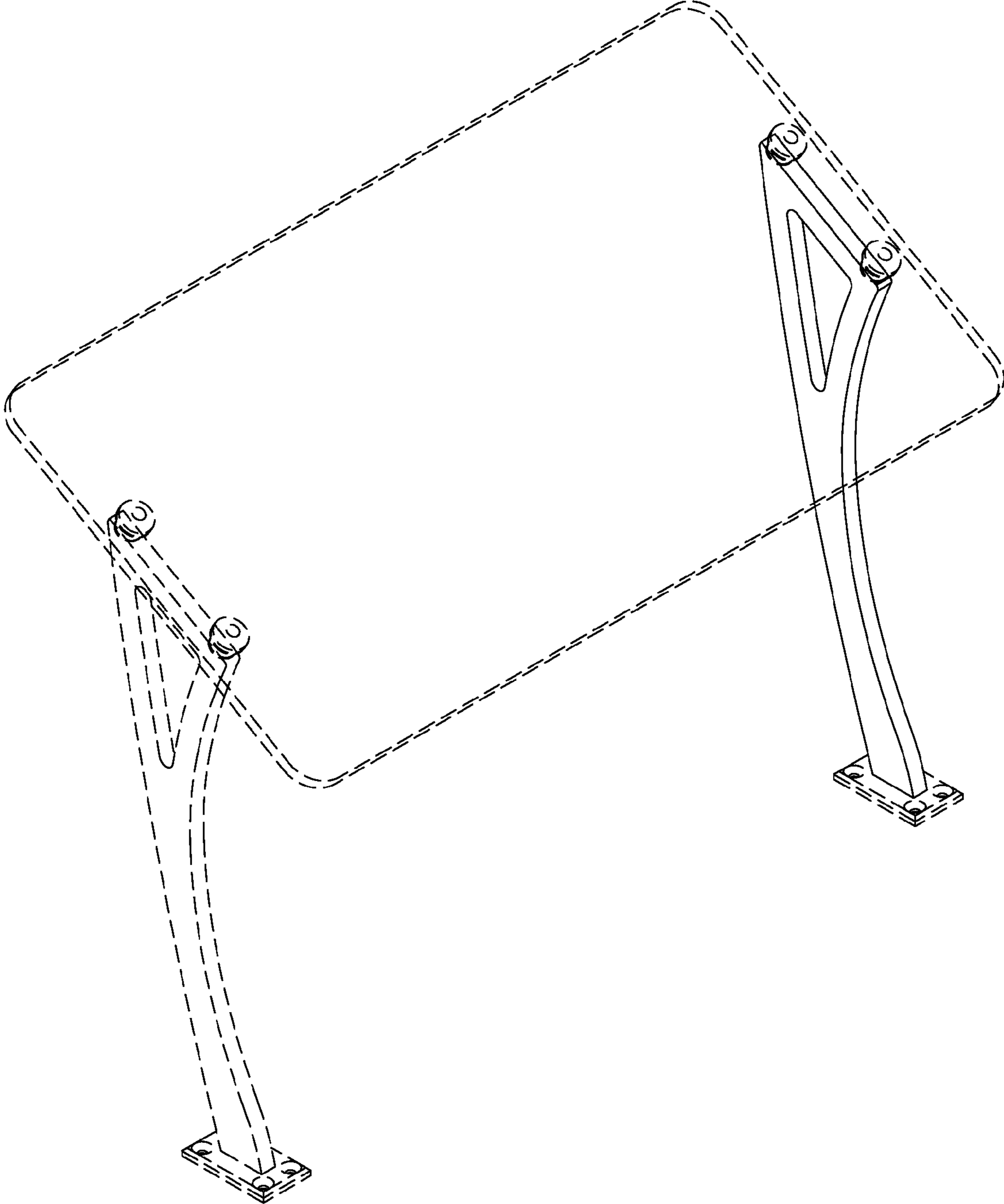

Fig 1

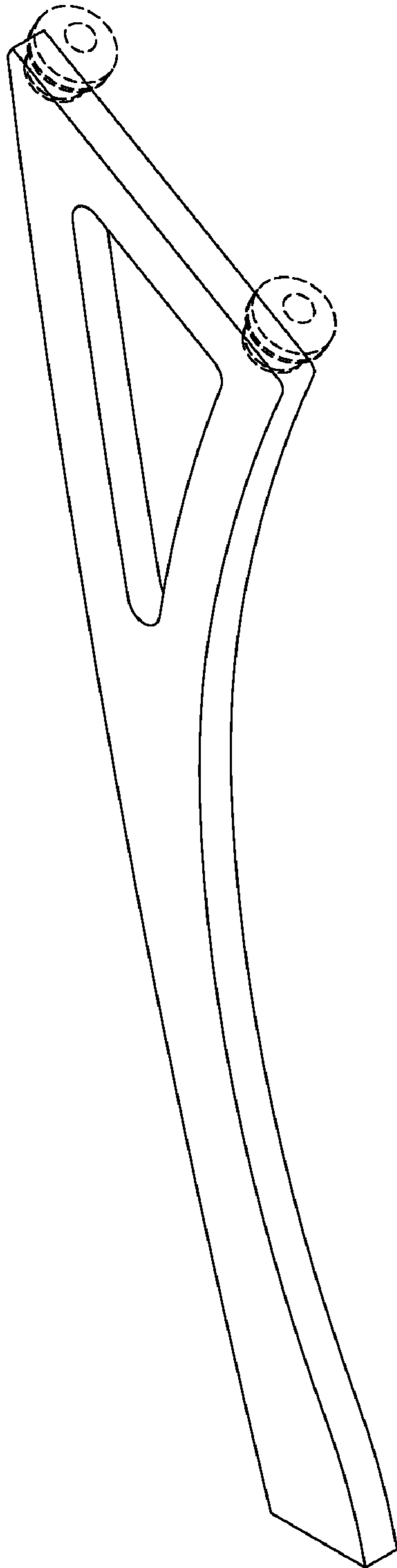

Fig 2

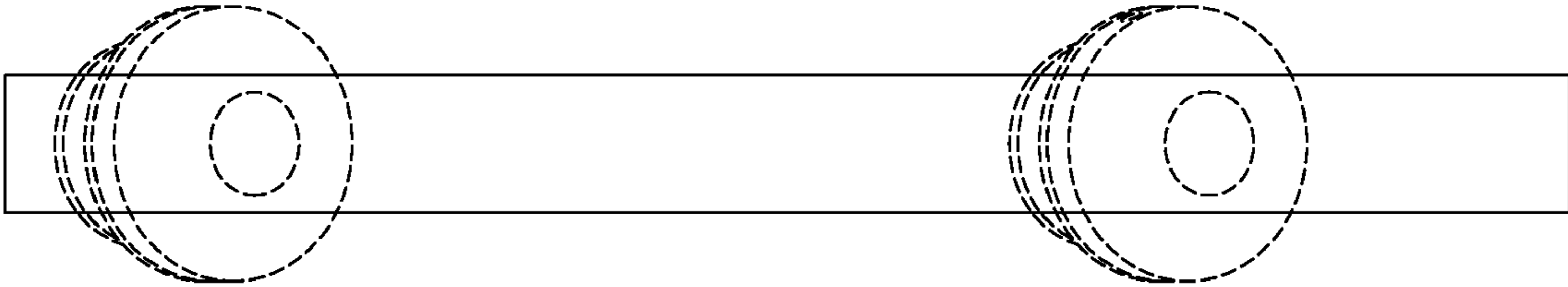

Fig 3

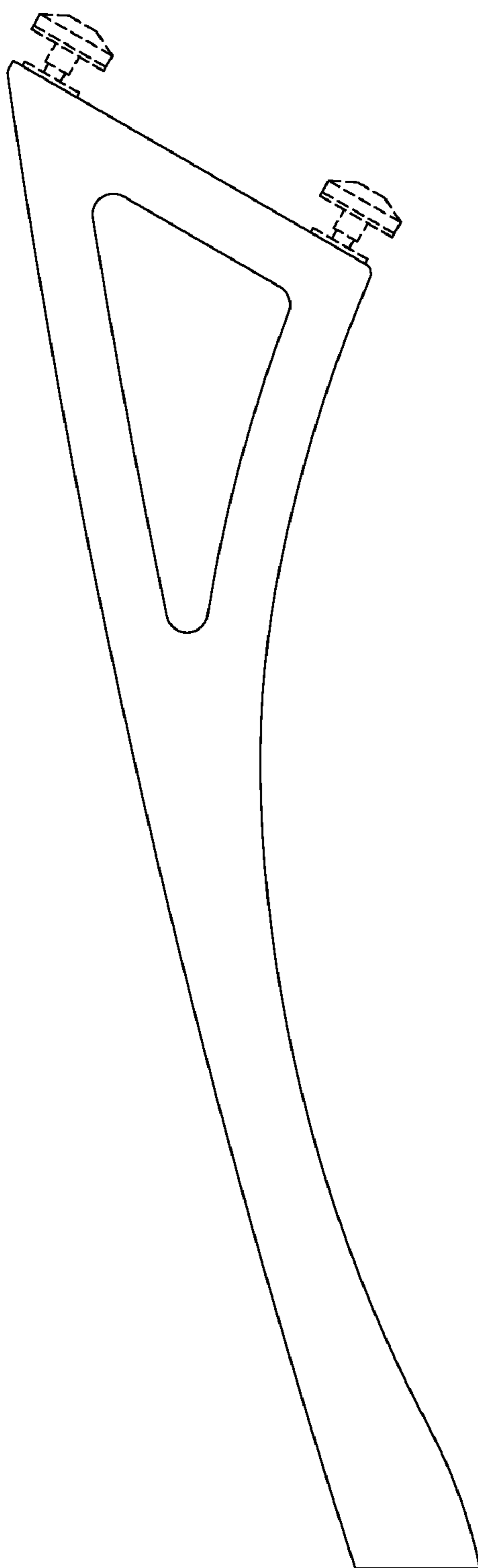

Fig 4

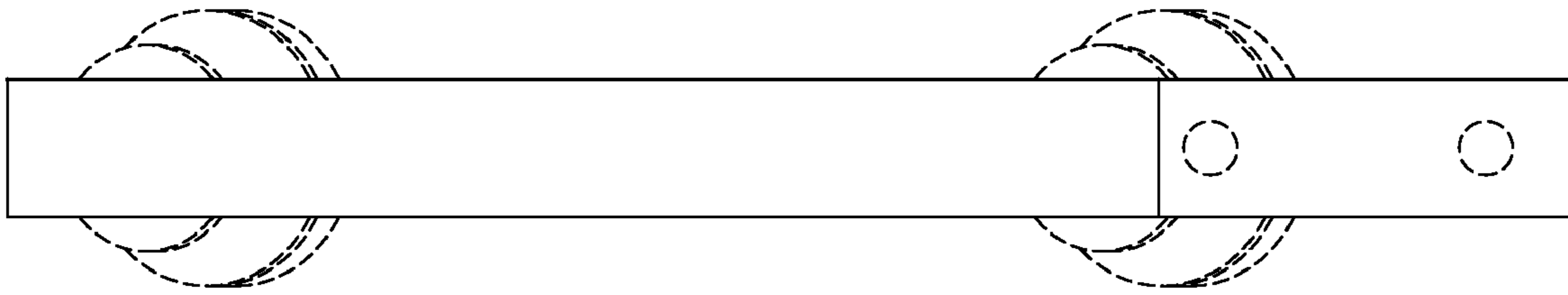

Fig 5

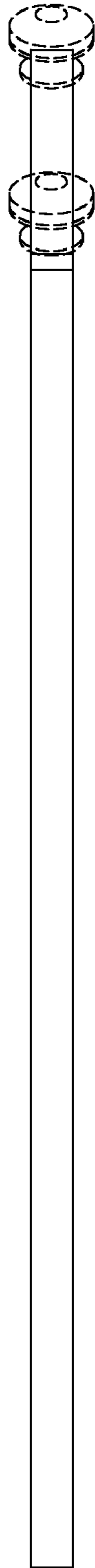

Fig 6