



US00D610334S

(12) **United States Design Patent**
Issler

(10) **Patent No.:** **US D610,334 S**

(45) **Date of Patent:** **** Feb. 23, 2010**

(54) **UPPER FOR A SHOE**

(75) Inventor: **David Issler**, Andover, MA (US)

(73) Assignee: **Columbia Insurance Company**,
Omaha, NE (US)

(**) Term: **14 Years**

(21) Appl. No.: **29/329,158**

(22) Filed: **Dec. 10, 2008**

(51) **LOC (9) Cl.** **02-99**

(52) **U.S. Cl.** **D2/971**

(58) **Field of Classification Search** D2/896,
D2/916-918, 925-942, 946, 969, 971; 36/1,
36/83, 8.3, 45-58, 11.5

See application file for complete search history.

(56) **References Cited**

U.S. PATENT DOCUMENTS

1,974,543 A	9/1934	Reymond	
D97,210 S *	10/1935	Shapiro	D2/933
D98,332 S *	1/1936	Liberty	D2/934
D99,809 S *	5/1936	Hyatt	D2/934
2,046,217 A	6/1936	Strauss	
D102,601 S *	1/1937	Carrabba	D2/933
D103,113 S *	2/1937	Lippert	D2/934
2,079,237 A	5/1937	Allard	
D108,333 S *	2/1938	Levine	D2/931
2,160,768 A	5/1939	Wasser	
2,344,069 A	3/1944	Wasser	
D154,469 S *	7/1949	Frederick et al.	D2/971
3,091,871 A	6/1963	Tronche	
3,175,310 A	3/1965	MacQuaid	
3,175,311 A	3/1965	MacQuaid	
3,191,321 A	6/1965	Brutting	
3,213,551 A	10/1965	Krauss	
3,407,518 A	10/1968	MacQuaid et al.	
3,525,165 A	8/1970	Randall, Jr.	
3,561,142 A	2/1971	Streit, Sr. et al.	
D256,518 S	8/1980	Moesle	
4,231,170 A	11/1980	Griswold	
4,366,629 A	1/1983	Scherz	

4,562,652 A	1/1986	Hensler	
4,908,963 A	3/1990	Krajcir et al.	
4,995,174 A	2/1991	Hong et al.	
5,048,203 A	9/1991	Kling	
5,185,944 A	2/1993	Okajima	
D335,953 S	6/1993	Tyng	
D345,453 S	3/1994	Carpenter	
5,499,459 A	3/1996	Tamaro	
5,526,584 A	6/1996	Bleimhofer et al.	
D381,494 S	7/1997	Anderson	
D384,798 S	10/1997	Gray	
5,738,937 A	4/1998	Baychar	
D402,449 S	12/1998	Robinson et al.	
D430,968 S	9/2000	Carroll	
6,161,315 A	12/2000	Dalton	
D468,083 S	1/2003	Morais	
D483,555 S	12/2003	Robinson, Jr. et al.	
D501,707 S	2/2005	Nakano	
D599,095 S *	9/2009	Issler	D2/971
D599,541 S *	9/2009	Issler	D2/971

* cited by examiner

Primary Examiner—Dominic Simone

(74) *Attorney, Agent, or Firm*—DeLio & Peterson, LLC;
David Chen

(57) **CLAIM**

The ornamental design for an upper for a shoe, as shown and described.

DESCRIPTION

FIG. 1 is a top perspective view of an upper for a shoe in accordance with my new design;

FIG. 2 is top view thereof;

FIG. 3 is a right side view thereof;

FIG. 4 is a left side view thereof;

FIG. 5 is a front view thereof; and,

FIG. 6 is a rear view thereof.

The broken lines shown in all of the figures are for environmental purposes and form no part of the claim.

1 Claim, 5 Drawing Sheets

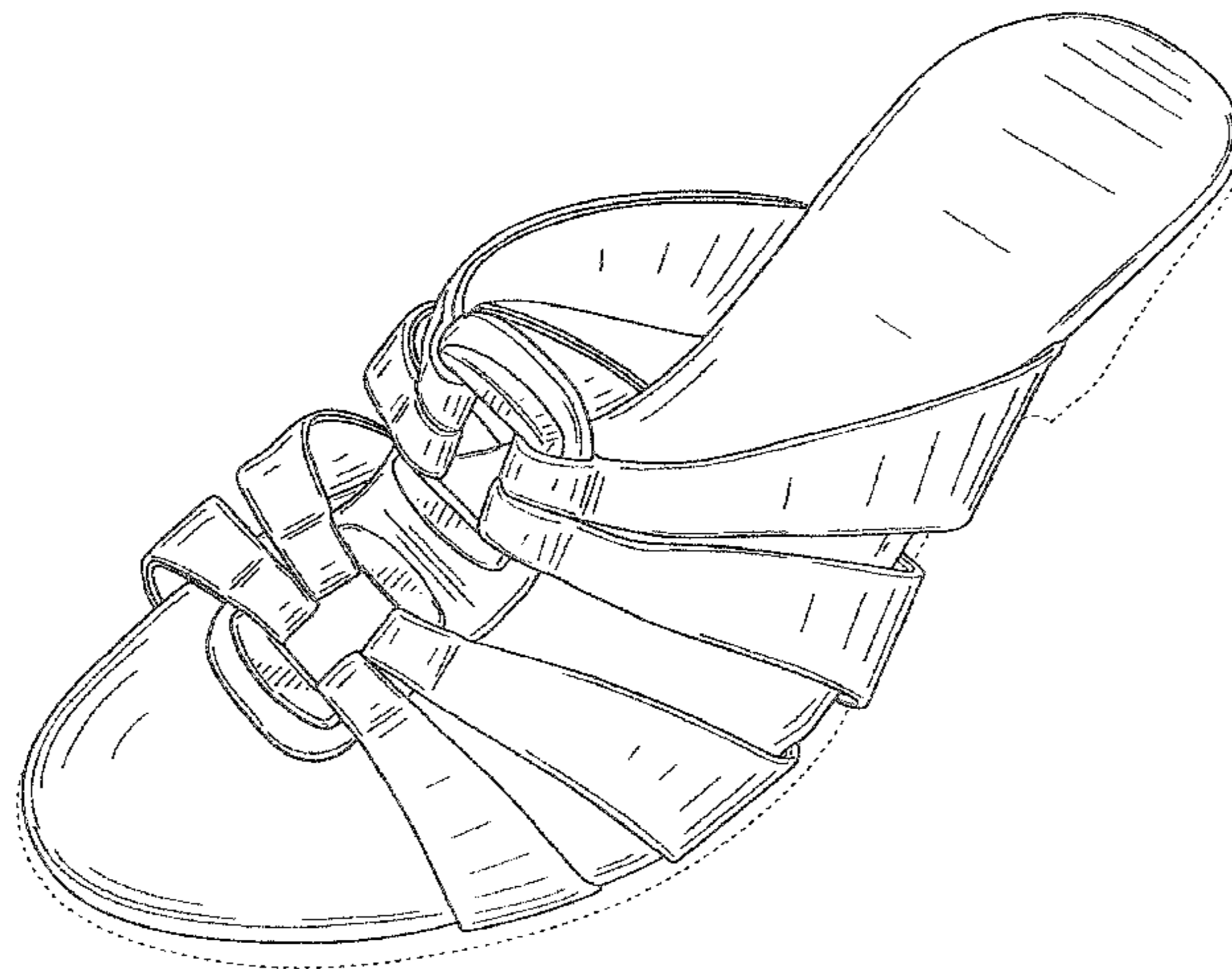

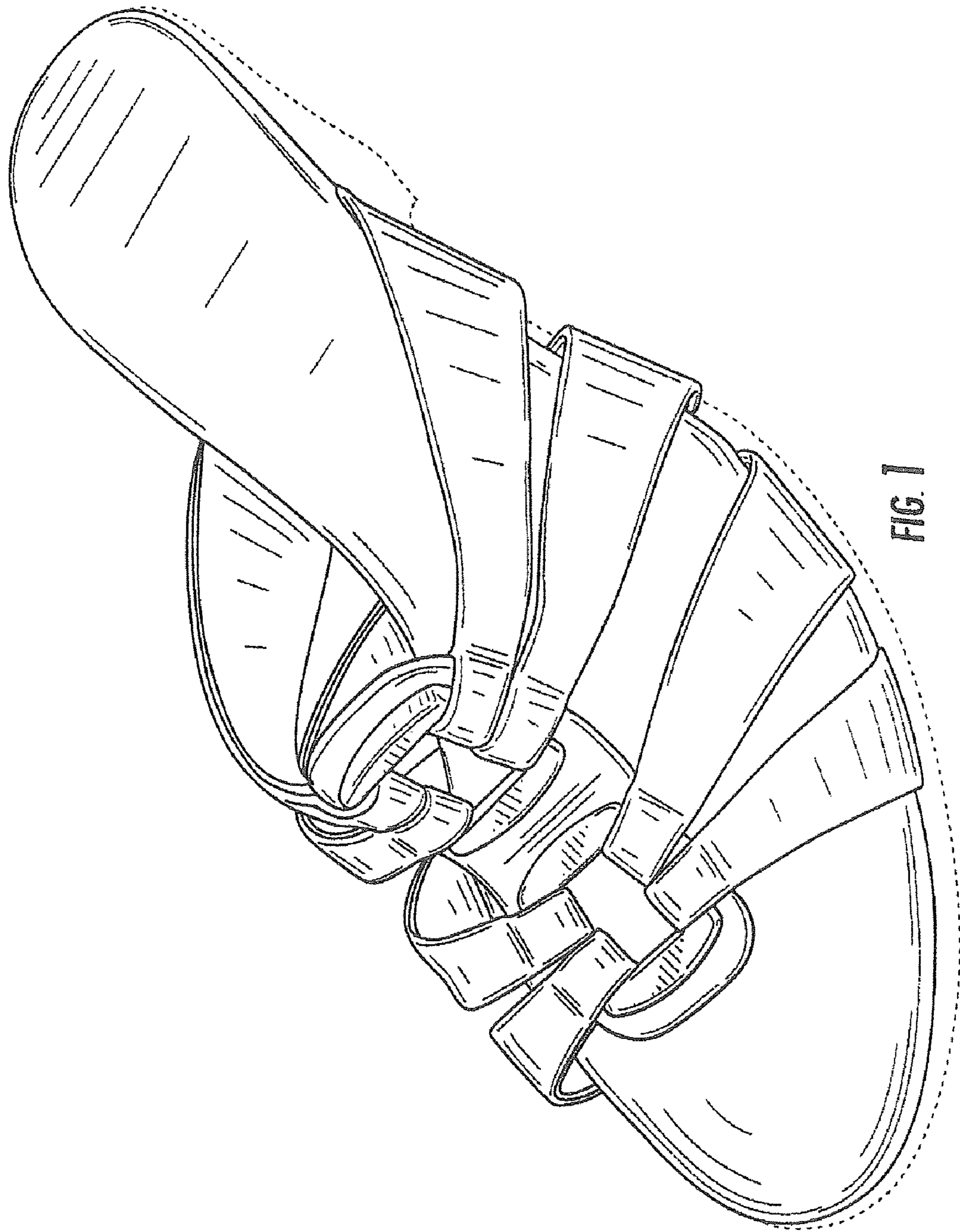

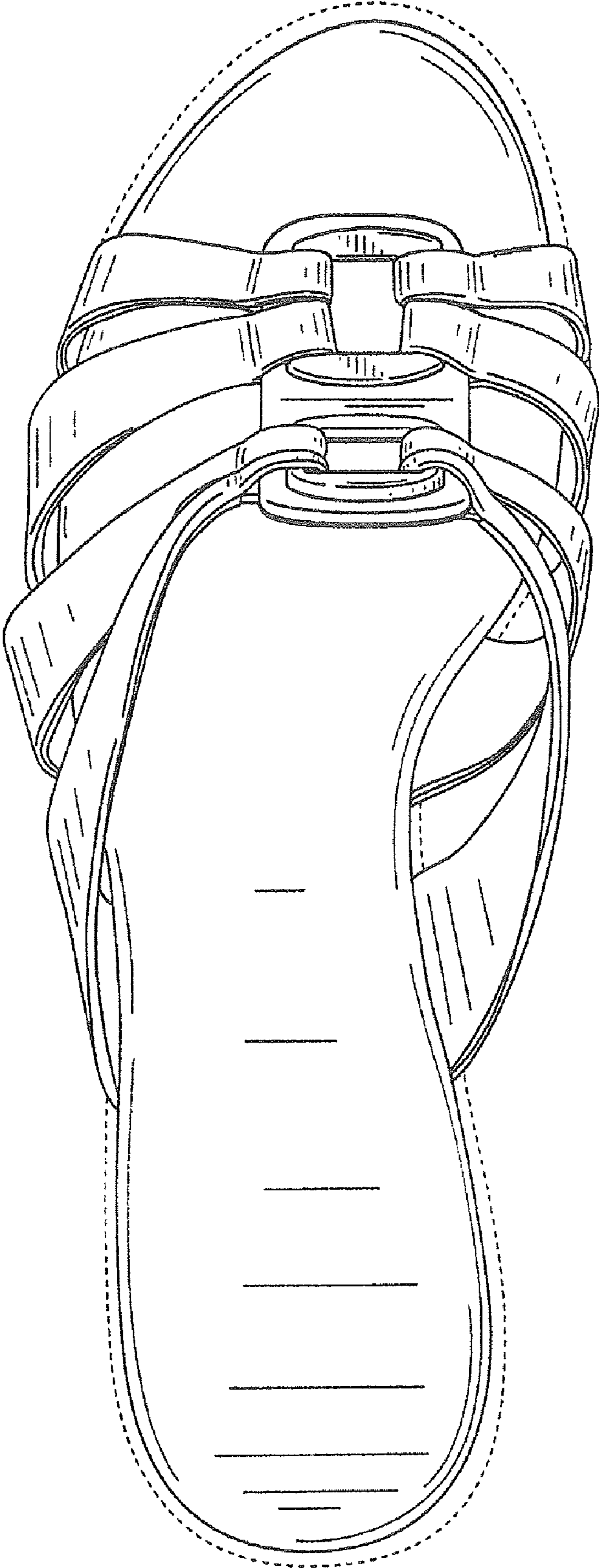

FIG. 2

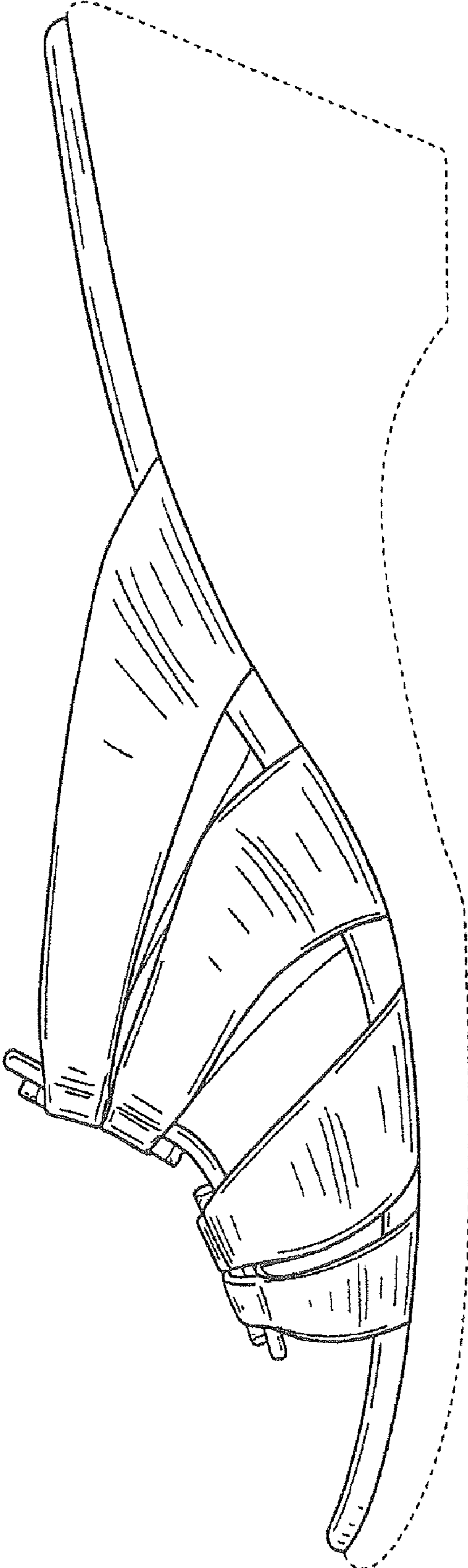

FIG. 3

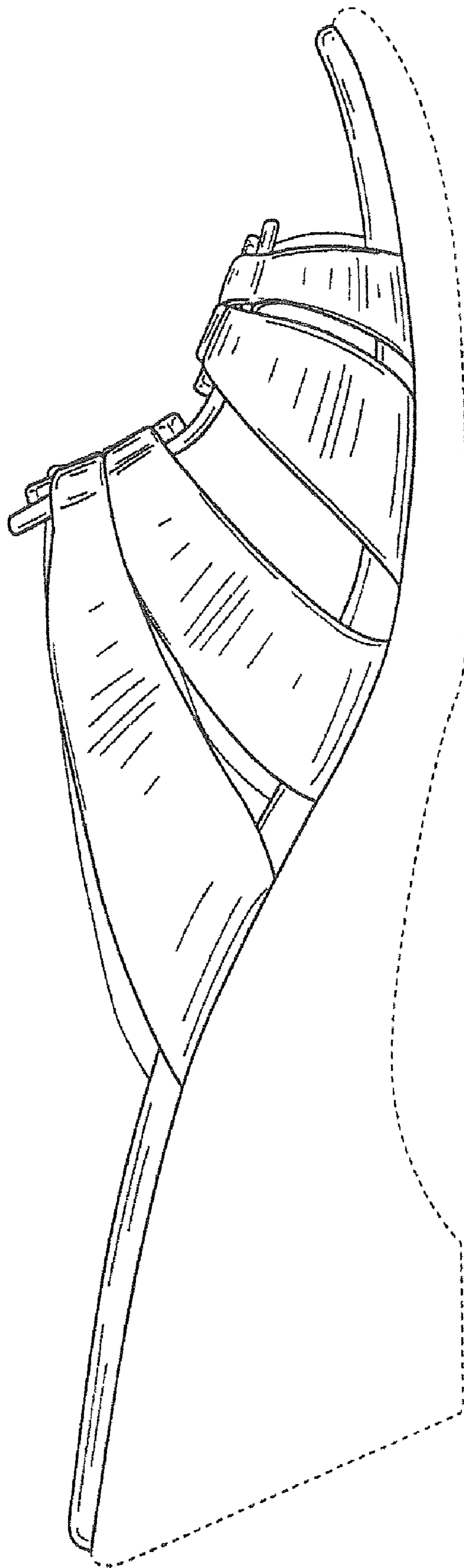

FIG. 4

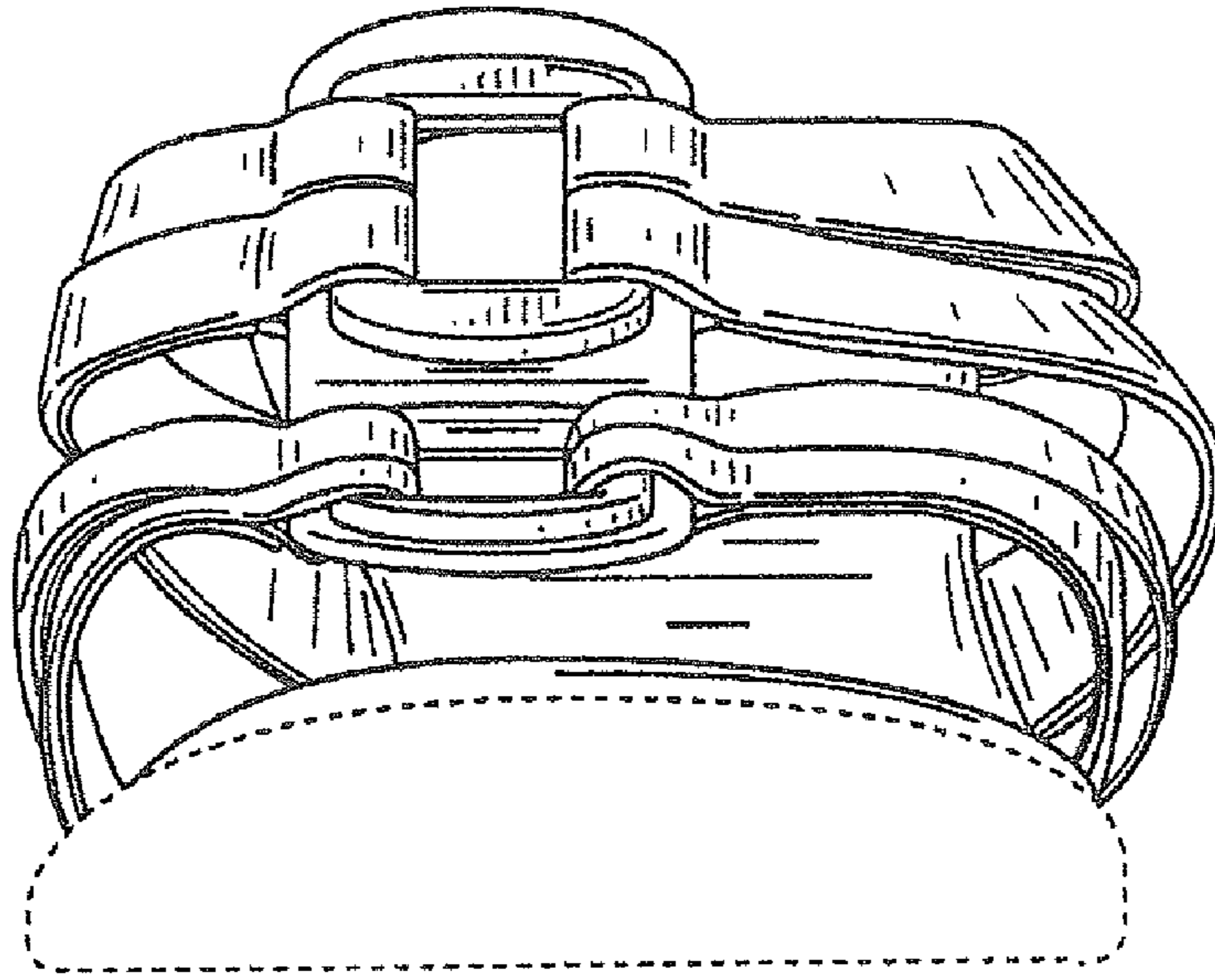

FIG. 5

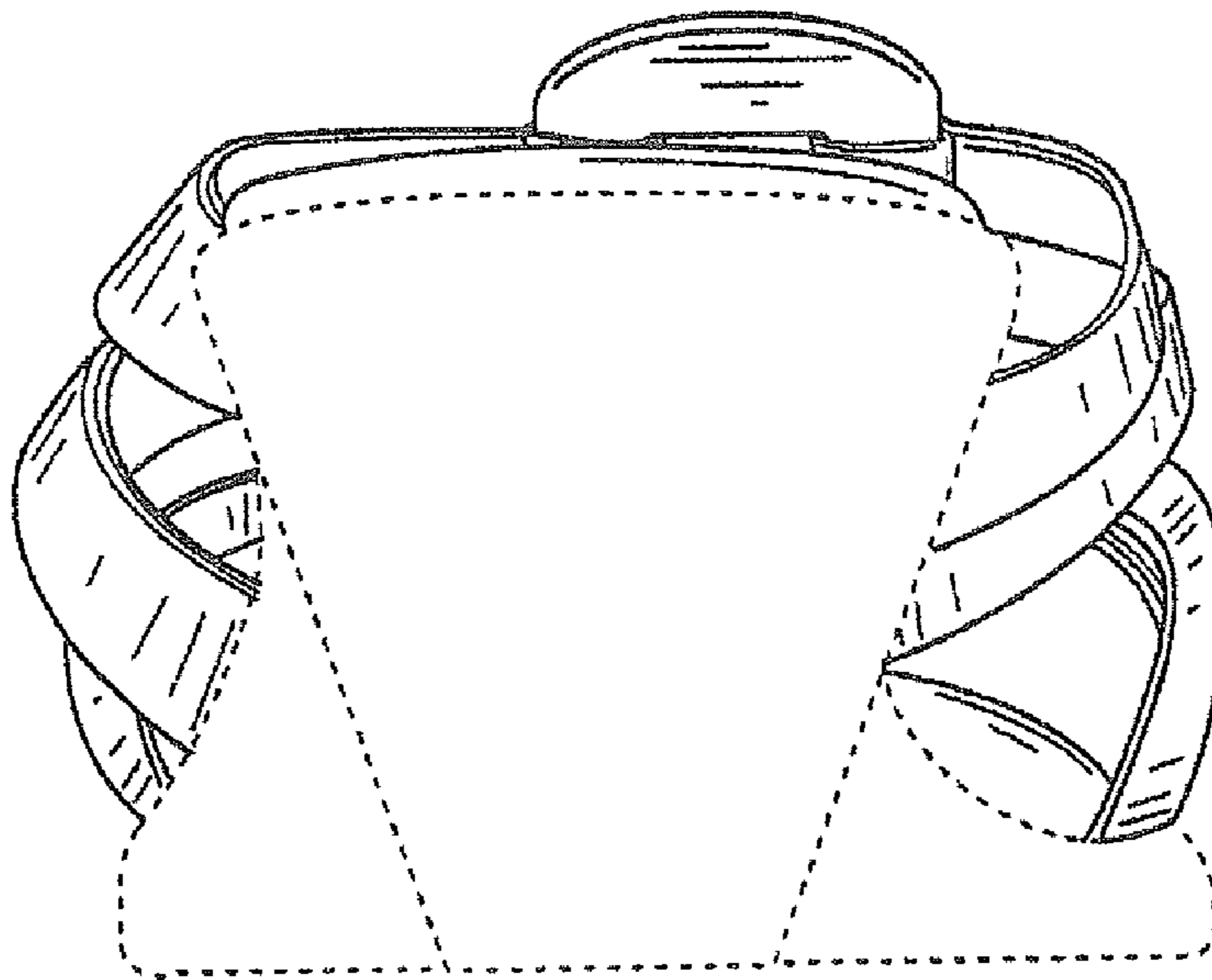

FIG. 6