



US00D610304S

(12) **United States Design Patent**
Hong et al.

(10) **Patent No.:** **US D610,304 S**
(45) **Date of Patent:** **** Feb. 16, 2010**

(54) **HAIR CUTTING TOOLS ORGANIZER**

(76) Inventors: **Hee Kyung Hong**, 474 Lincoln Ave.,
Wyckoff, NJ (US) 07481; **Je K. Hong**,
474 Lincoln Ave., Wyckoff, NJ (US)
07481

(**) Term: **14 Years**

(21) Appl. No.: **29/313,896**

(22) Filed: **Feb. 18, 2009**

(51) **LOC (9) Cl.** **28-03**

(52) **U.S. Cl.** **D28/9; D6/469**

(58) **Field of Classification Search** D28/9,
D28/10, 73; D6/466, 467, 469, 567, 513,
D6/411; 211/60.1, 70.6; 206/351, 581, 372-375;
D19/75

See application file for complete search history.

(56) **References Cited**

U.S. PATENT DOCUMENTS

4,653,637 A * 3/1987 Wallace 211/70.6

(Continued)

Primary Examiner—Jennifer Rivard

(74) *Attorney, Agent, or Firm*—Law Office of Sergei Orel,
LLC

(57) **CLAIM**

We claim the ornamental design for a hair cutting tools orga-
nizer, as shown and described.

DESCRIPTION

FIG. 1 is a front view of the first embodiment of the hair
cutting tools organizer showing our new design;

FIG. 2 is a top view thereof;

FIG. 3 is a top view of the second embodiment with five round
holes;

FIG. 4 is a top view of the third embodiment with three round
holes;

FIG. 5 is a top view of the fourth embodiment with four
square holes;

FIG. 6 is a top view of the fifth embodiment with five square
holes;

FIG. 7 is a top view of the sixth embodiment with three square
holes;

FIG. 8 is a top view of the seventh embodiment with four
triangular holes;

FIG. 9 is a top view of the eighth embodiment with five
triangular holes;

FIG. 10 is a top view of the ninth embodiment with three
triangular holes;

FIG. 11 is a top view of the tenth embodiment with four oval
holes;

FIG. 12 is a top view of the eleventh embodiment with five
oval holes;

FIG. 13 is a top view of the twelfth embodiment with three
oval holes;

FIG. 14 is a top view of the thirteenth embodiment with four
diamond shaped holes;

FIG. 15 is a top view of the fourteenth embodiment with five
diamond shaped holes;

FIG. 16 is a top view of the fifteenth embodiment with three
diamond shaped holes;

FIG. 17 is a bottom view of the first embodiment;

FIG. 18 is a rear view of the first embodiment;

FIG. 19 is a side view of the first embodiment;

FIG. 20 is a cross sectional view taken along line 20—20 in
FIG. 22;

FIG. 21 is a perspective view of the first embodiment;

FIG. 22 is an additional perspective view of the first embodi-
ment; and,

FIG. 23 is an additional perspective view of the first embodi-
ment with hair cutting tools shown in broken lines. The bro-
ken lines are shown for illustrative purposes only and form no
part of the claimed design.

With the exception of the top view of the organizer, the
remaining views of embodiments 2–16 are identical to the
first embodiment.

1 Claim, 9 Drawing Sheets

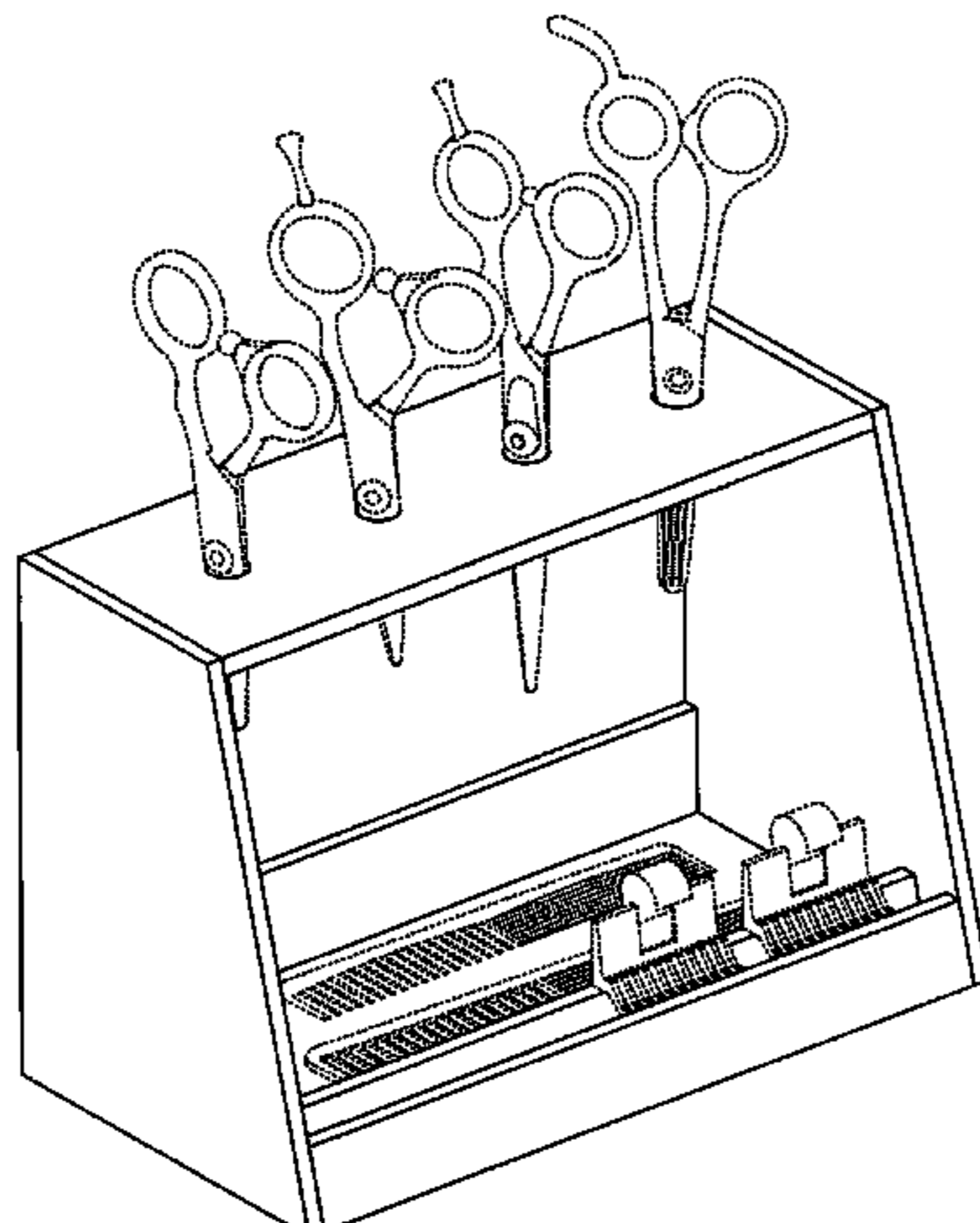

US D610,304 S

Page 2

U.S. PATENT DOCUMENTS

4,907,705 A *	3/1990	Waldeck	D6/467	D333,770 S *	3/1993	Jureckson	D6/469
5,054,625 A *	10/1991	Foley	211/60.1	D584,856 S *	1/2009	Kirschenmann	D28/73
D321,800 S *	11/1991	Blum	D6/411	D584,857 S *	1/2009	Kirschenmann	D28/73

* cited by examiner

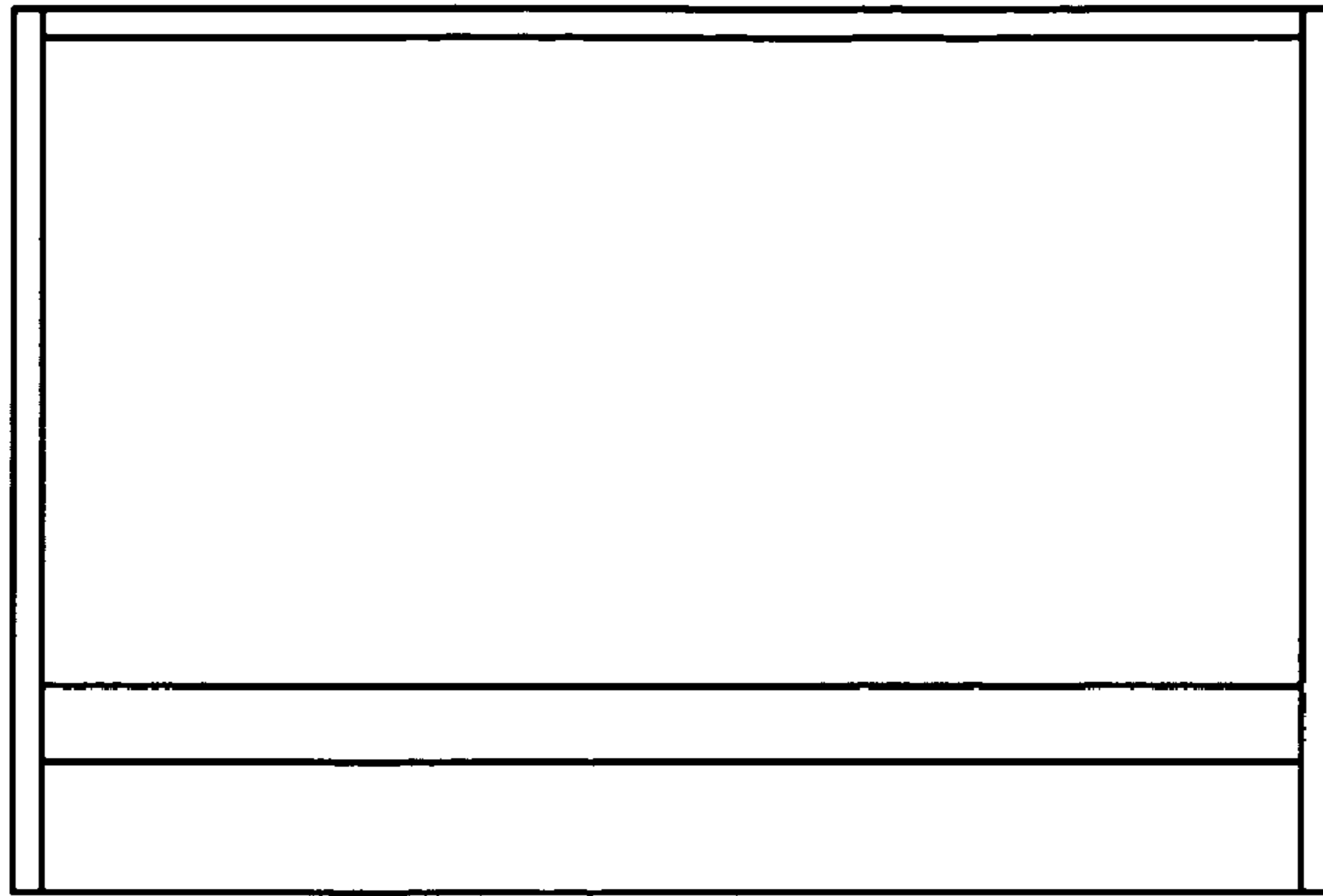

Fig.1

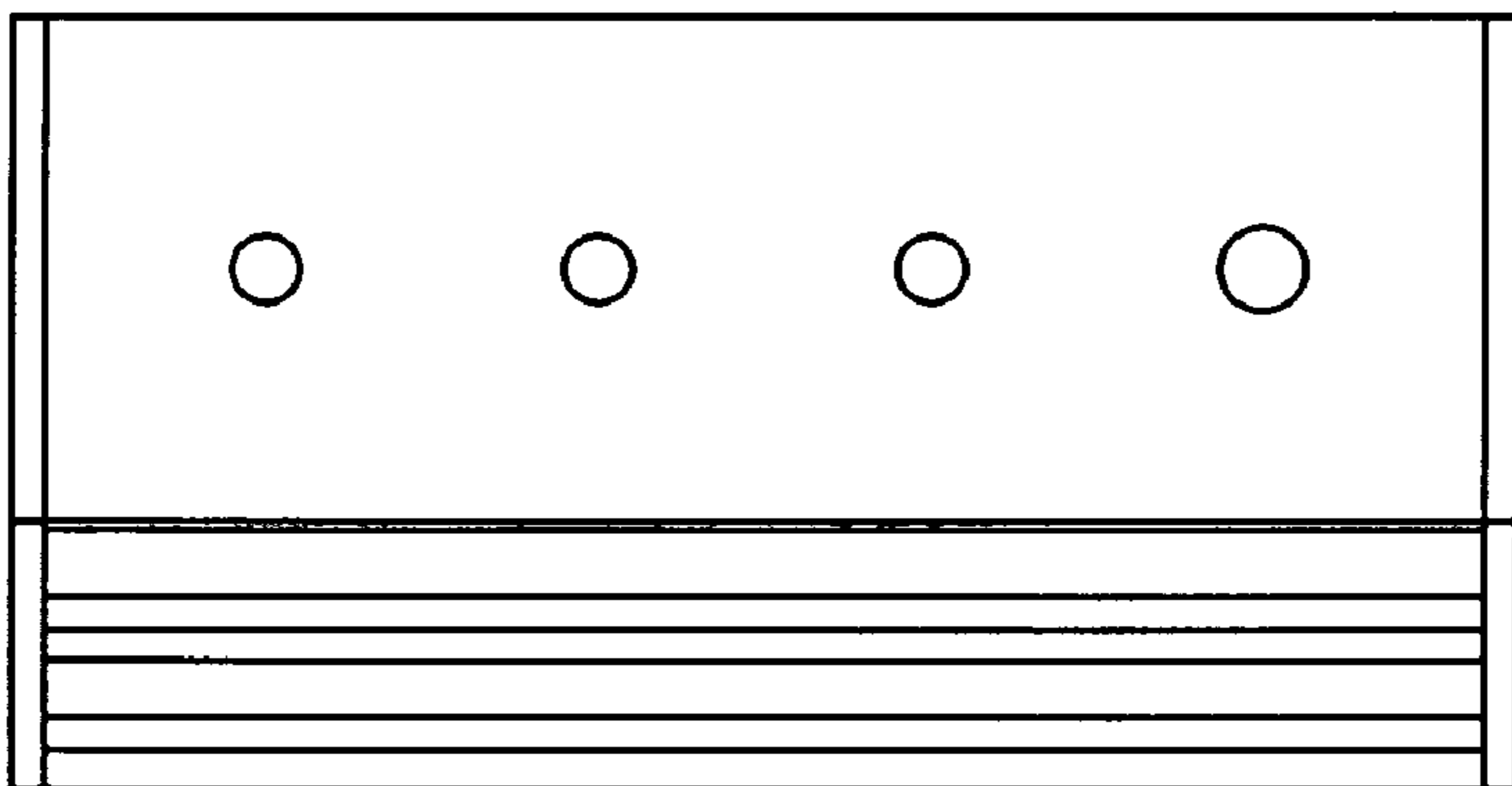

Fig.2

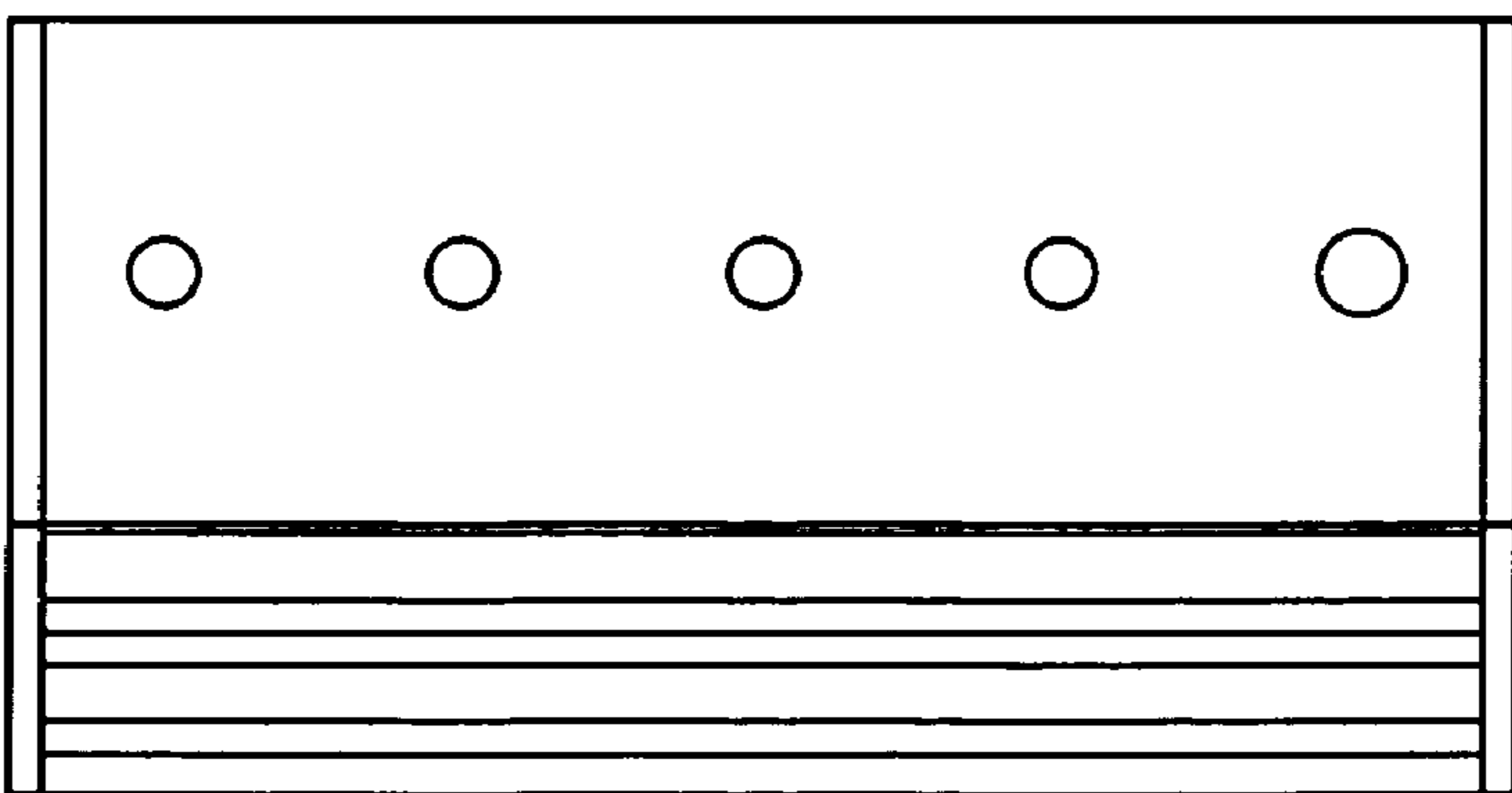

Fig.3

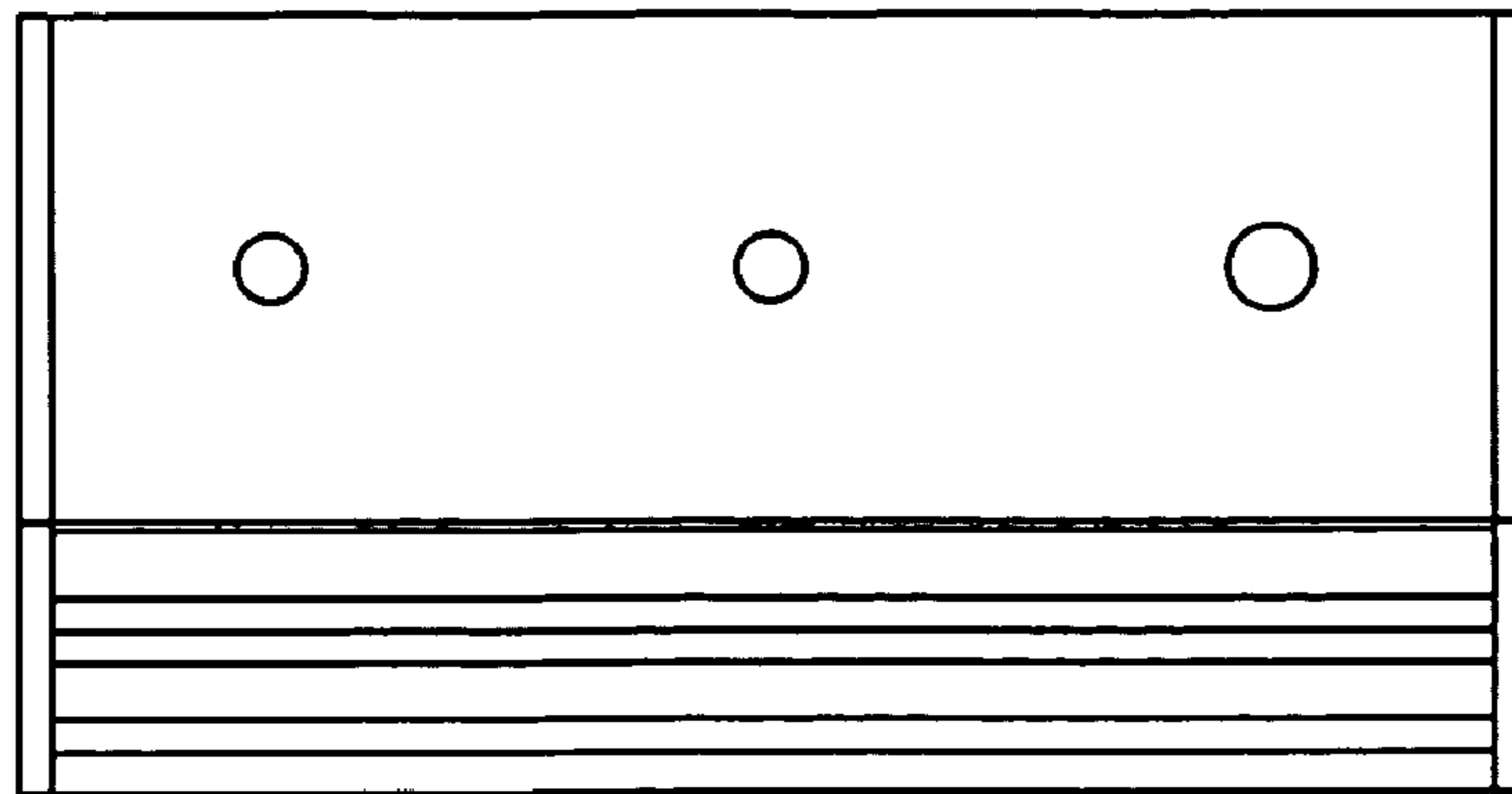

Fig.4

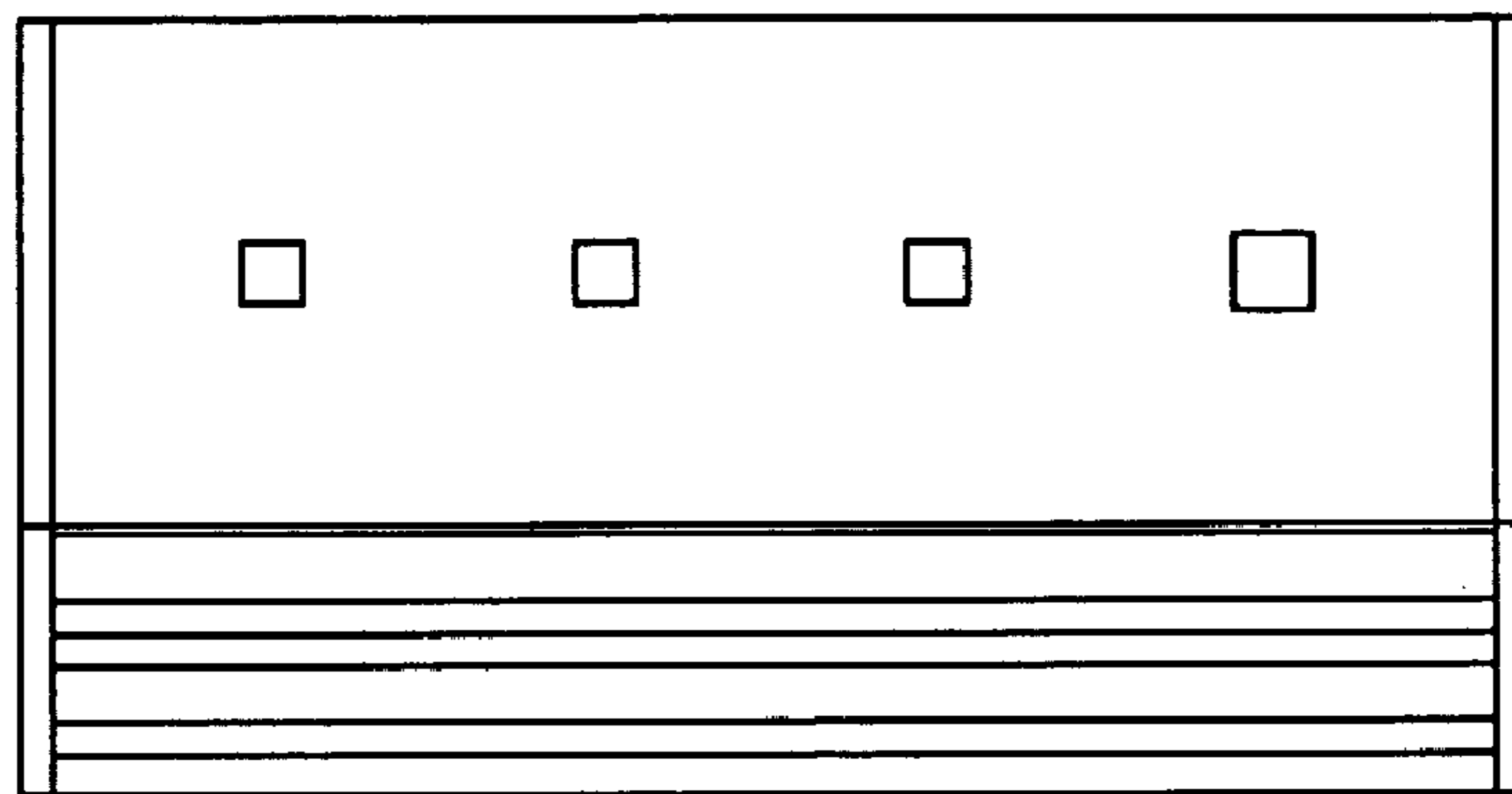

Fig.5

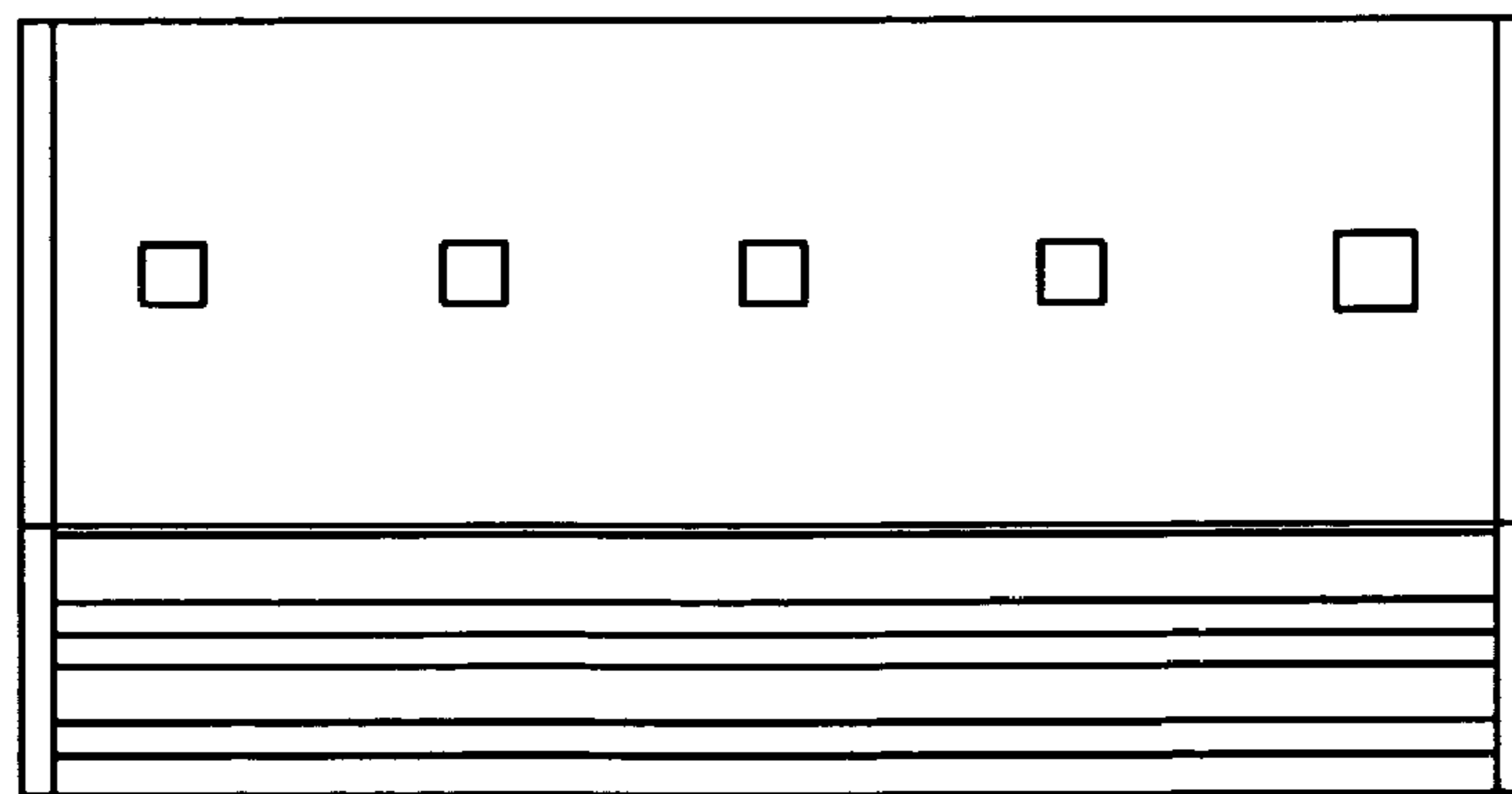

Fig.6

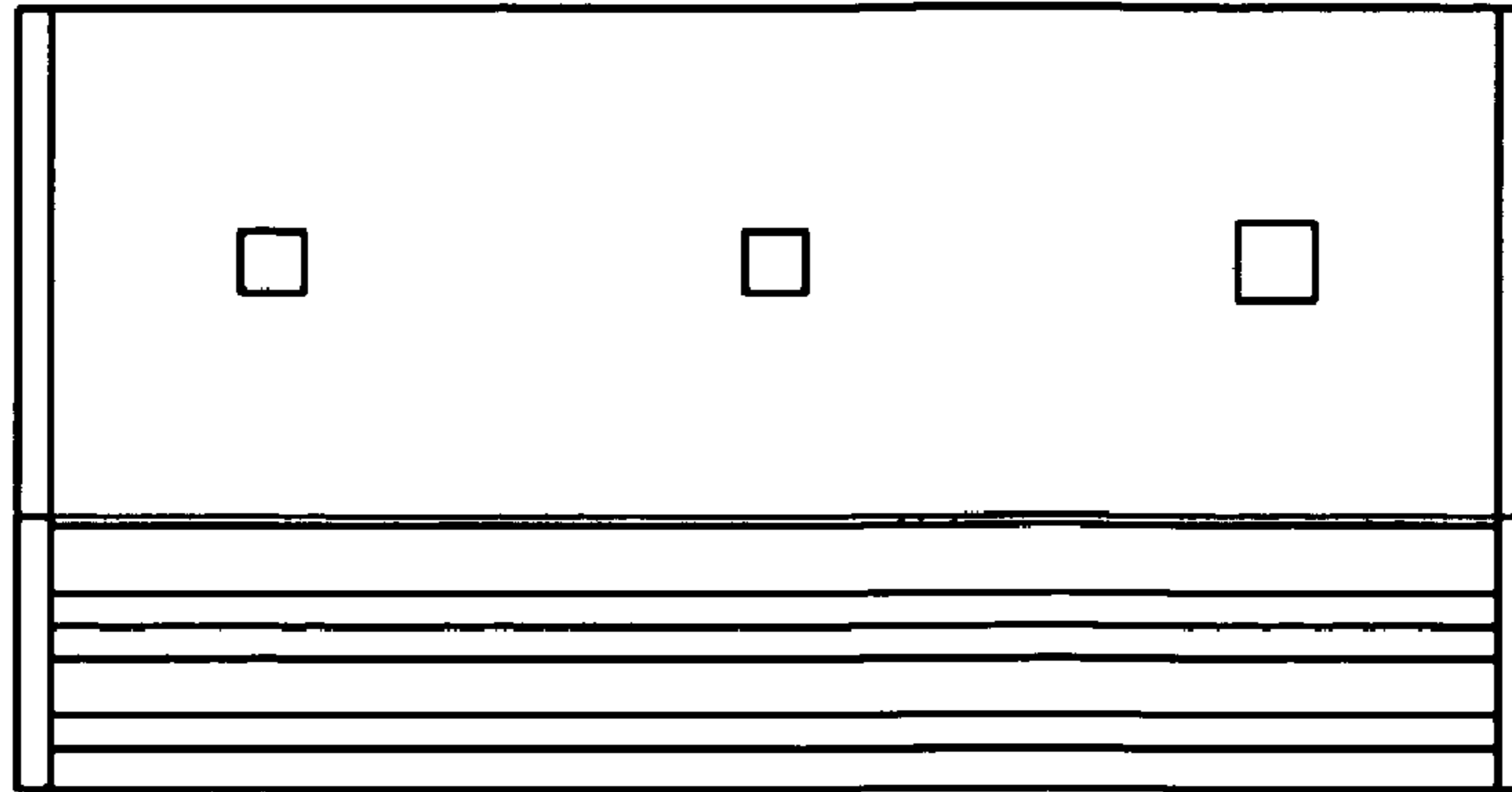

Fig.7

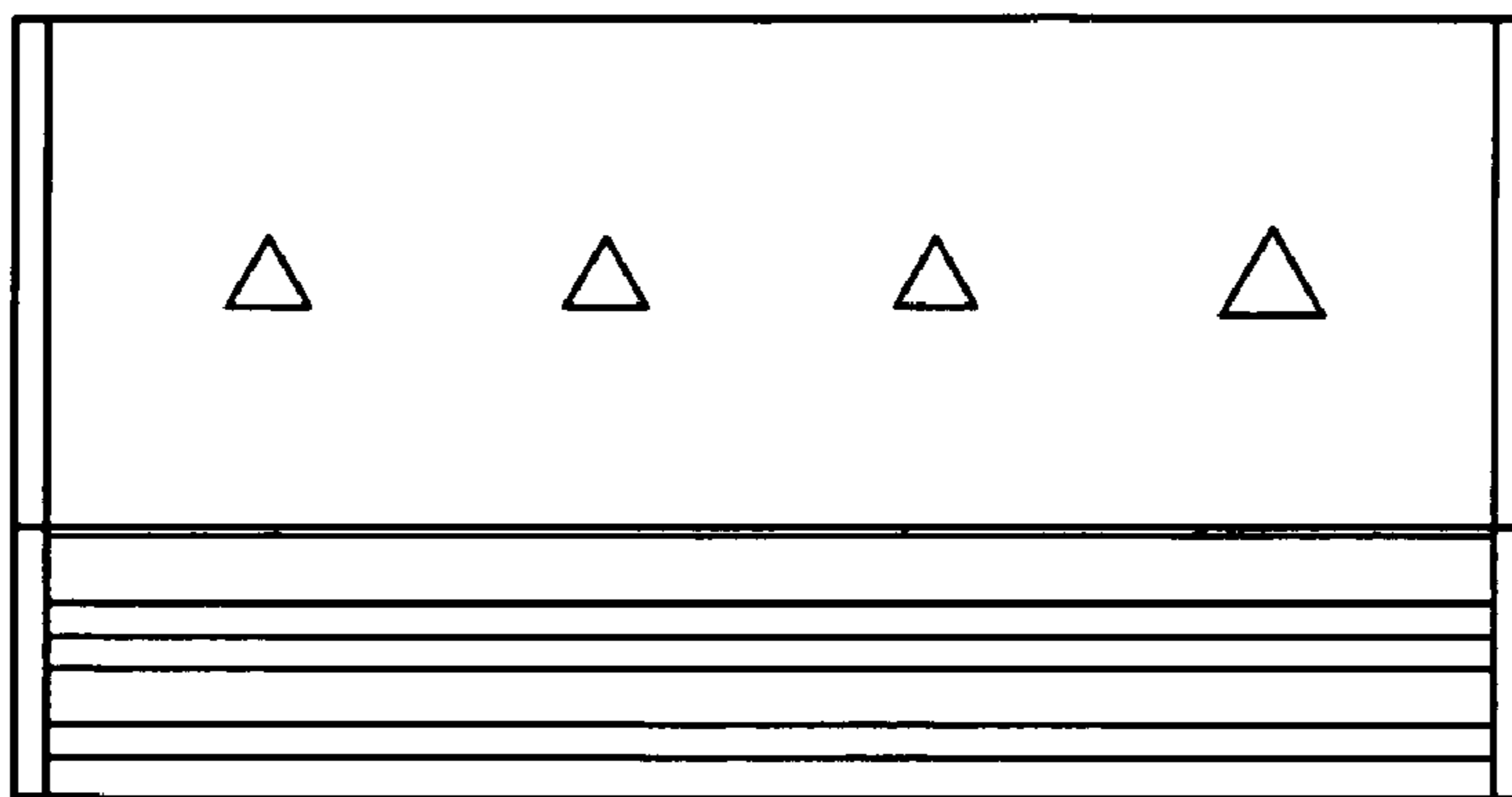

Fig.8

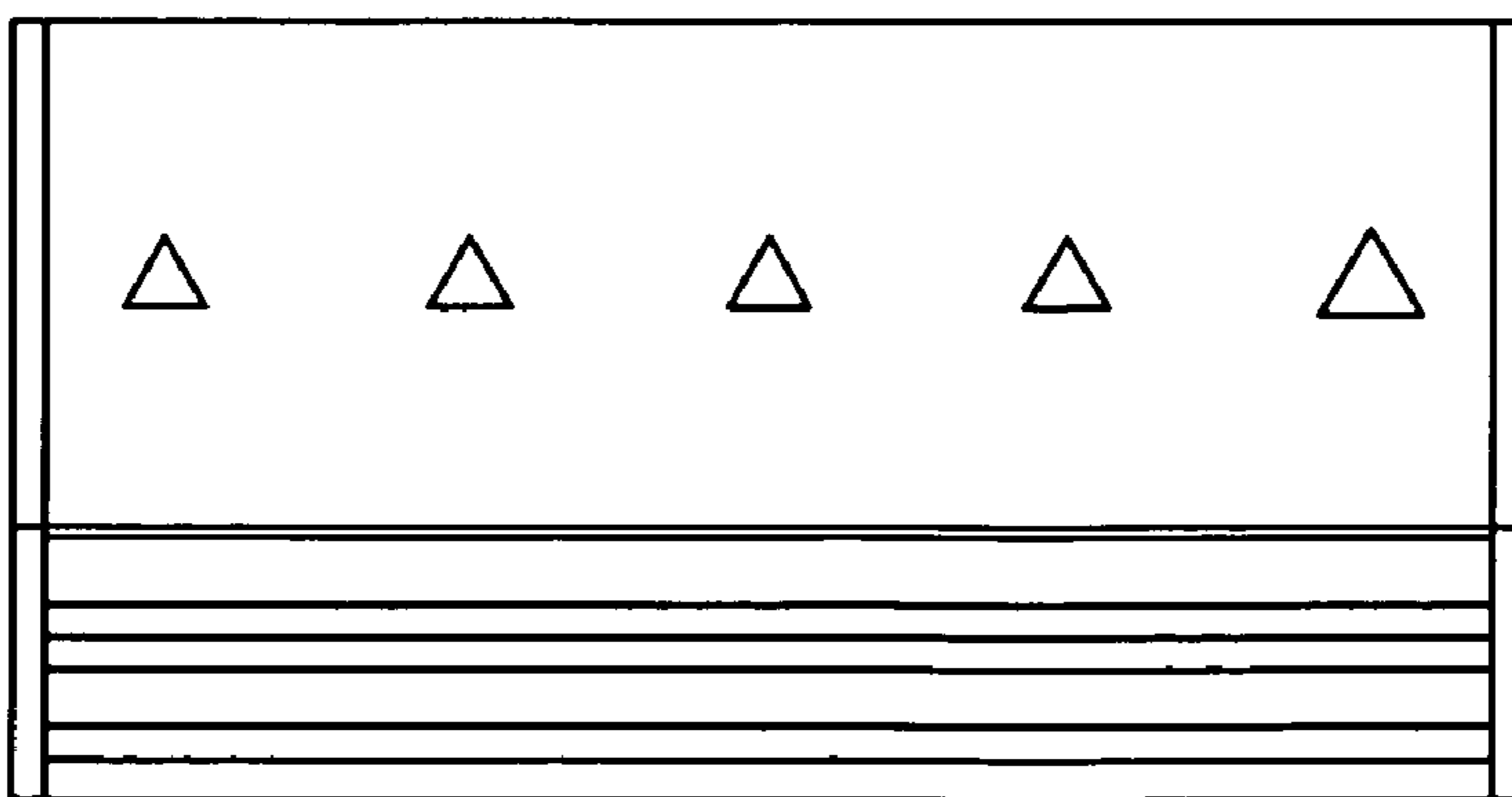

Fig.9

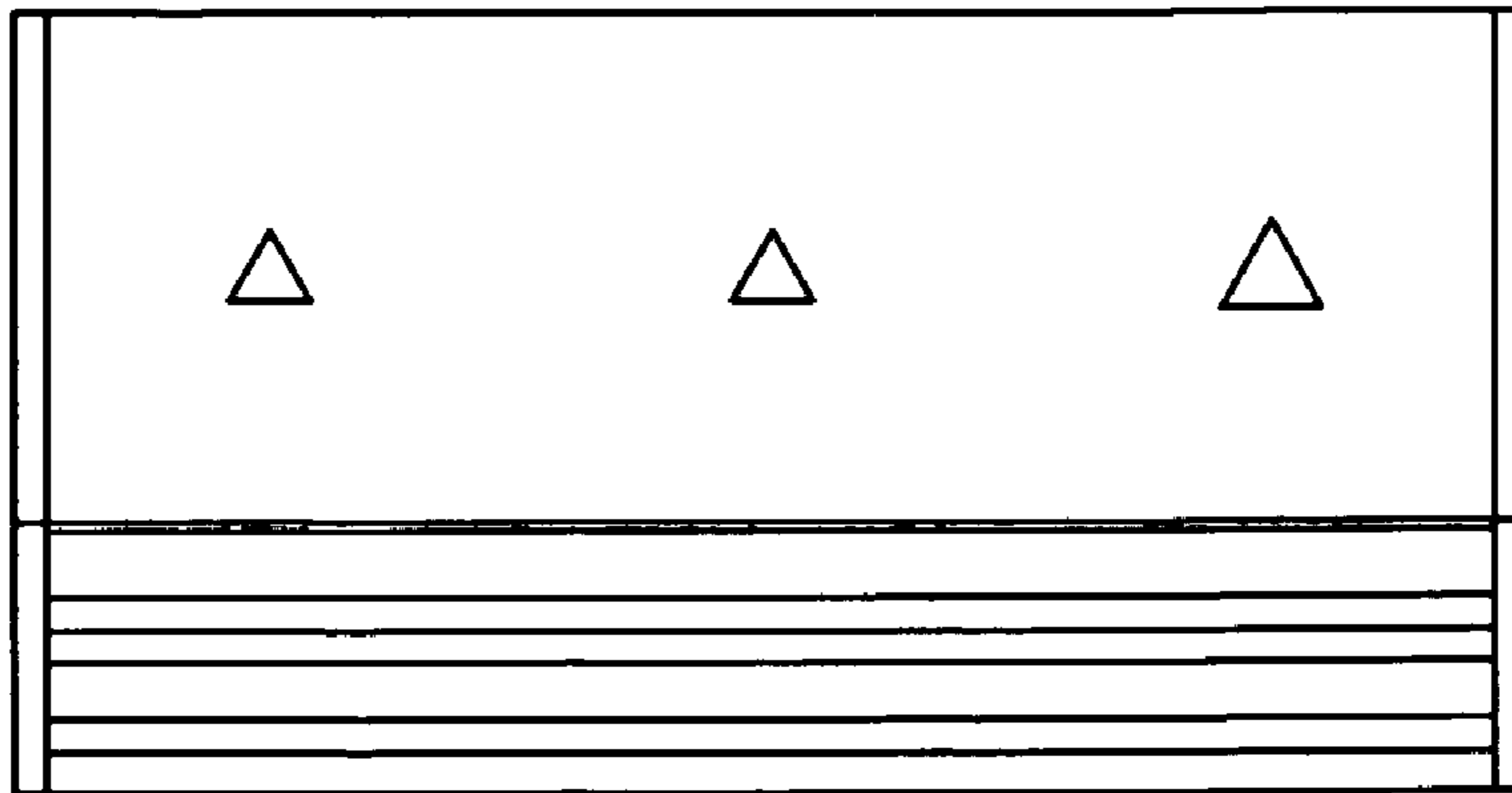

Fig.10

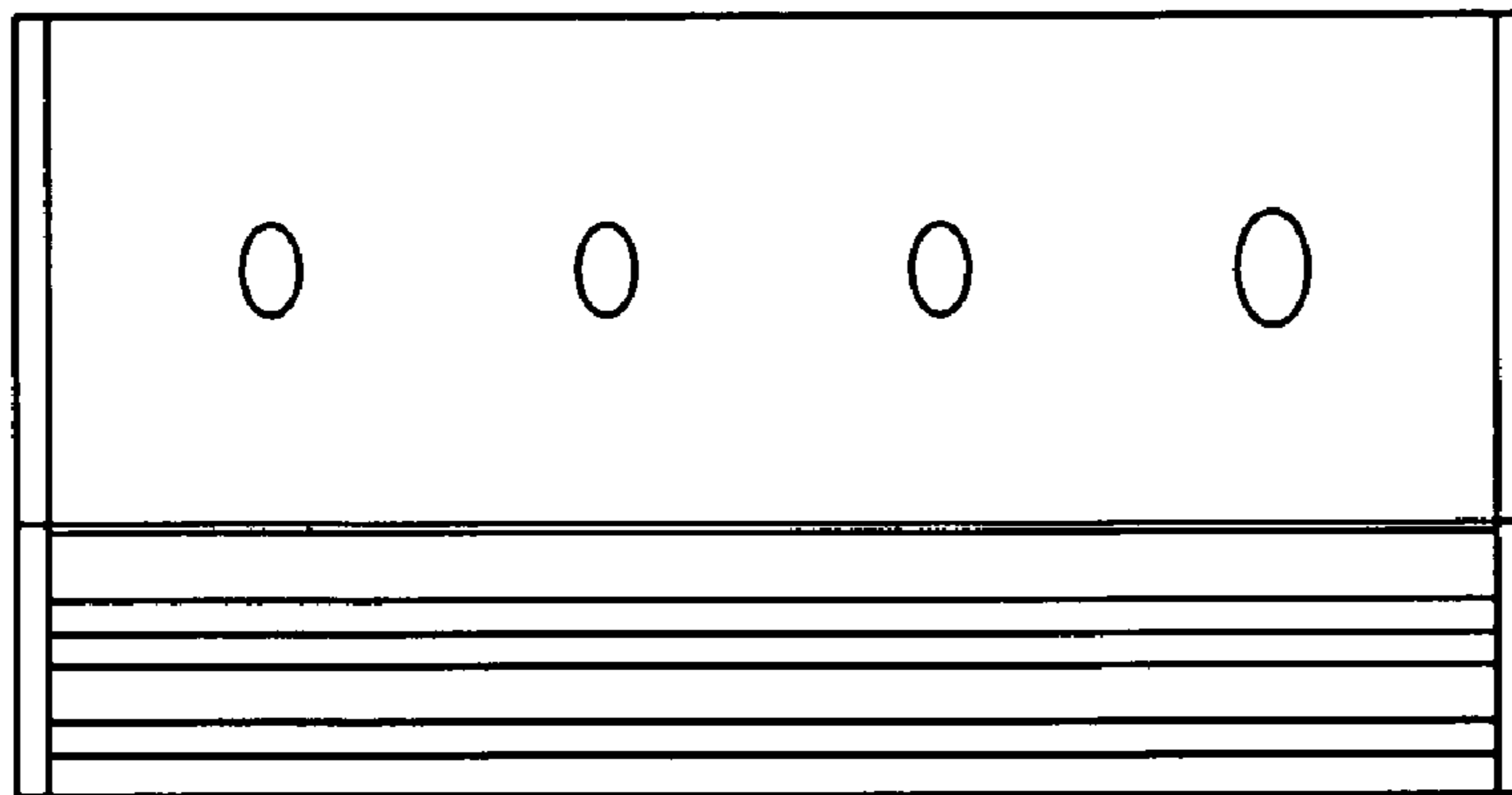

Fig.11

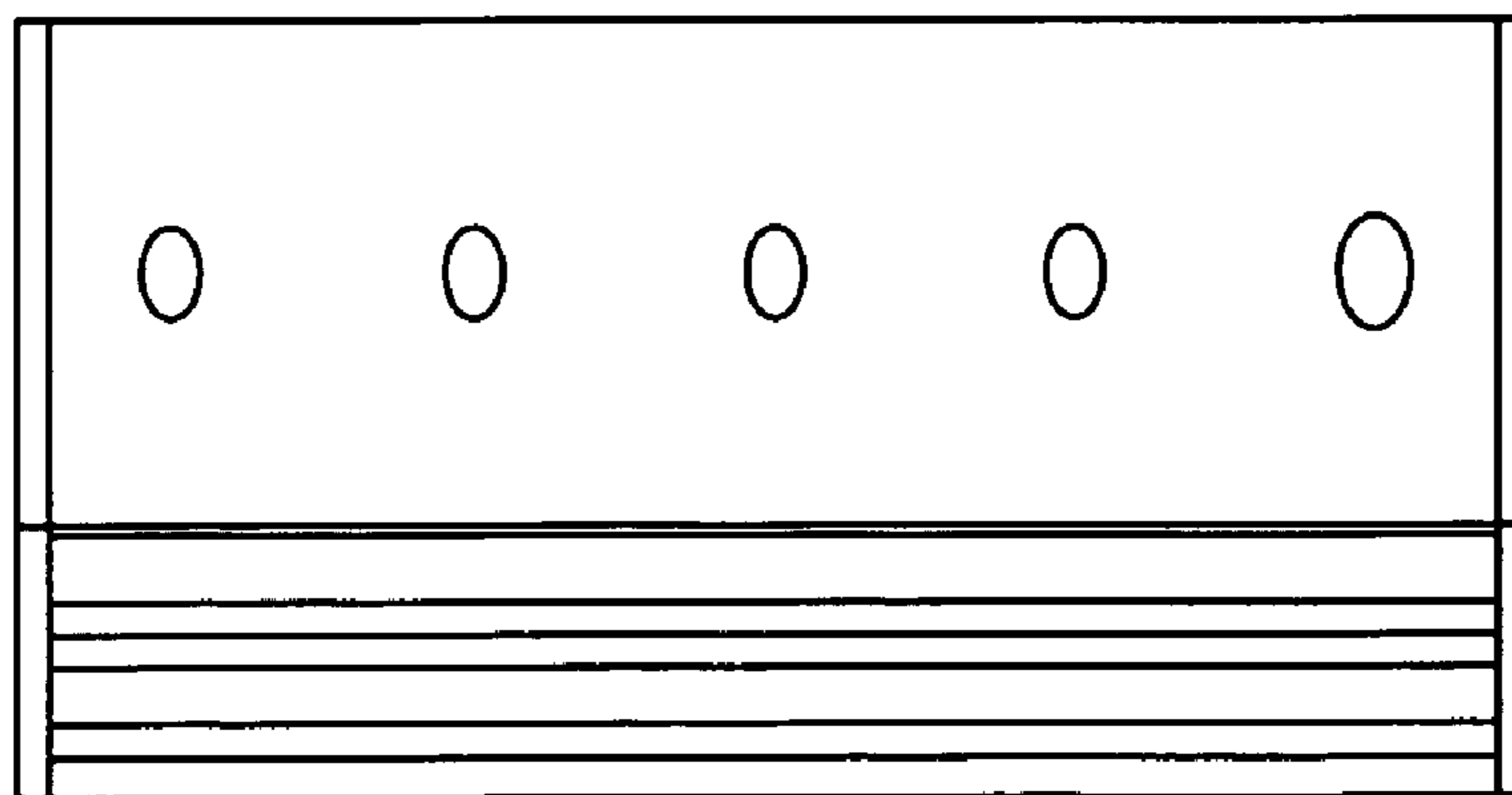

Fig.12

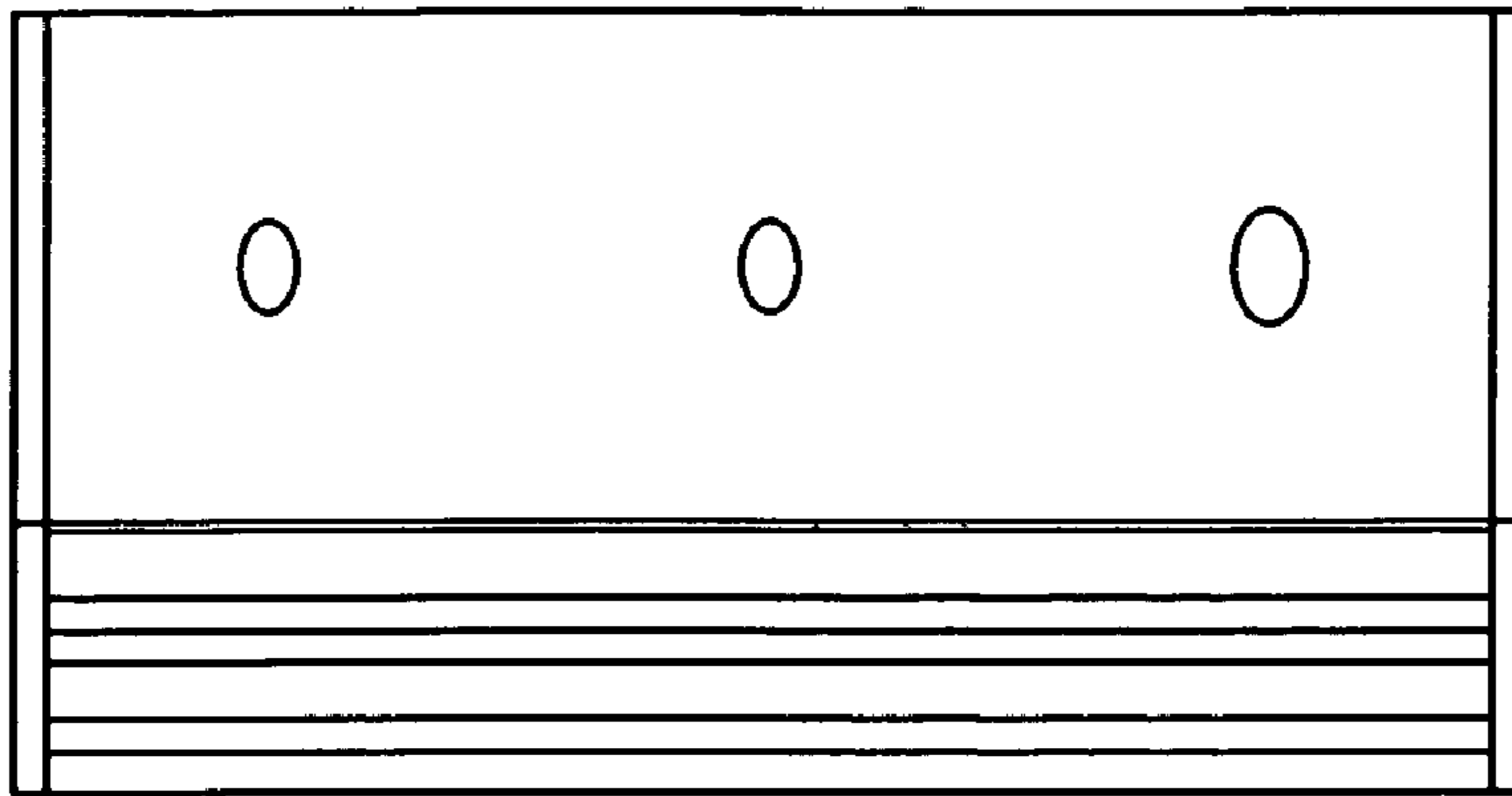

Fig.13

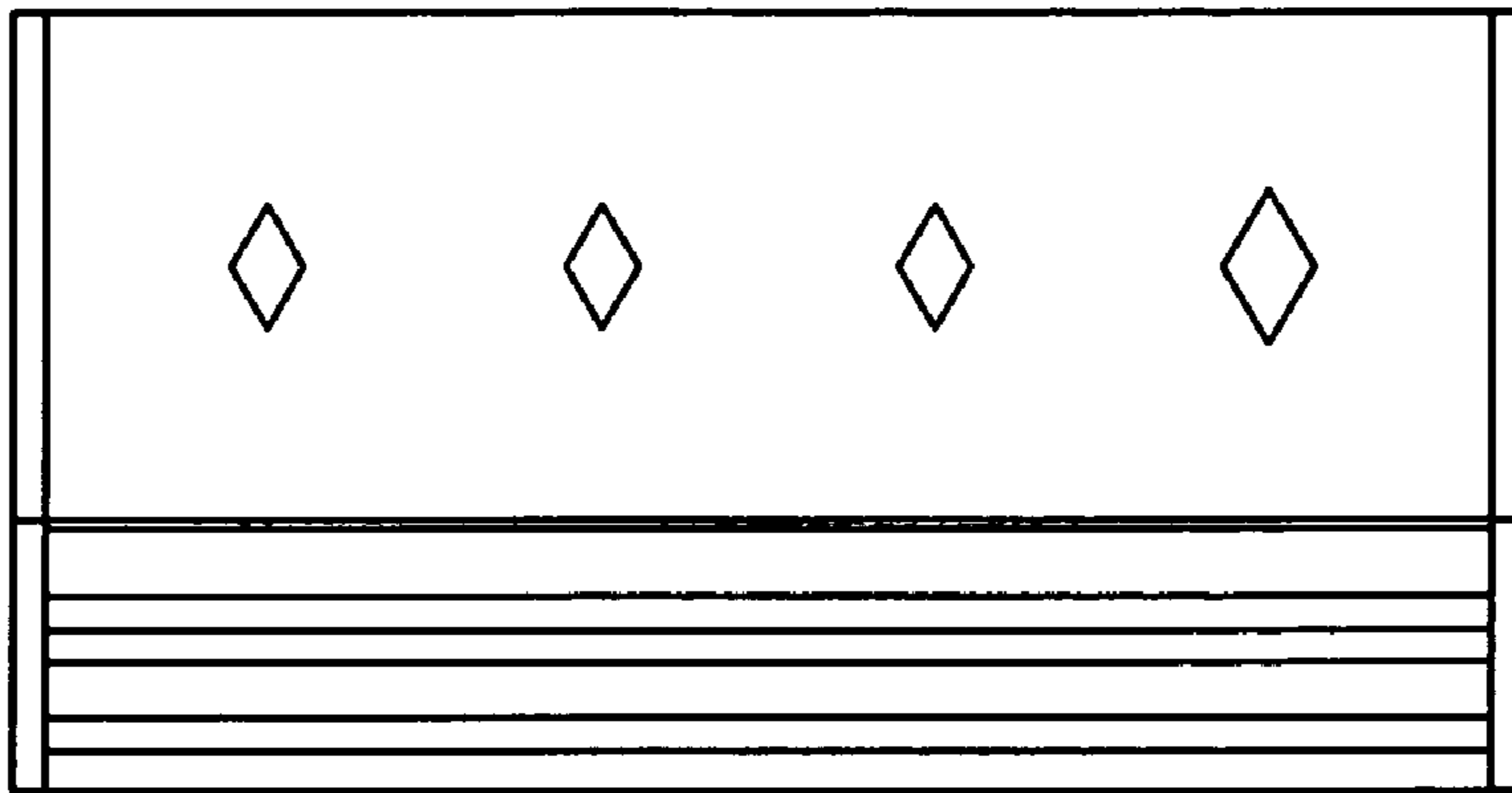

Fig.14

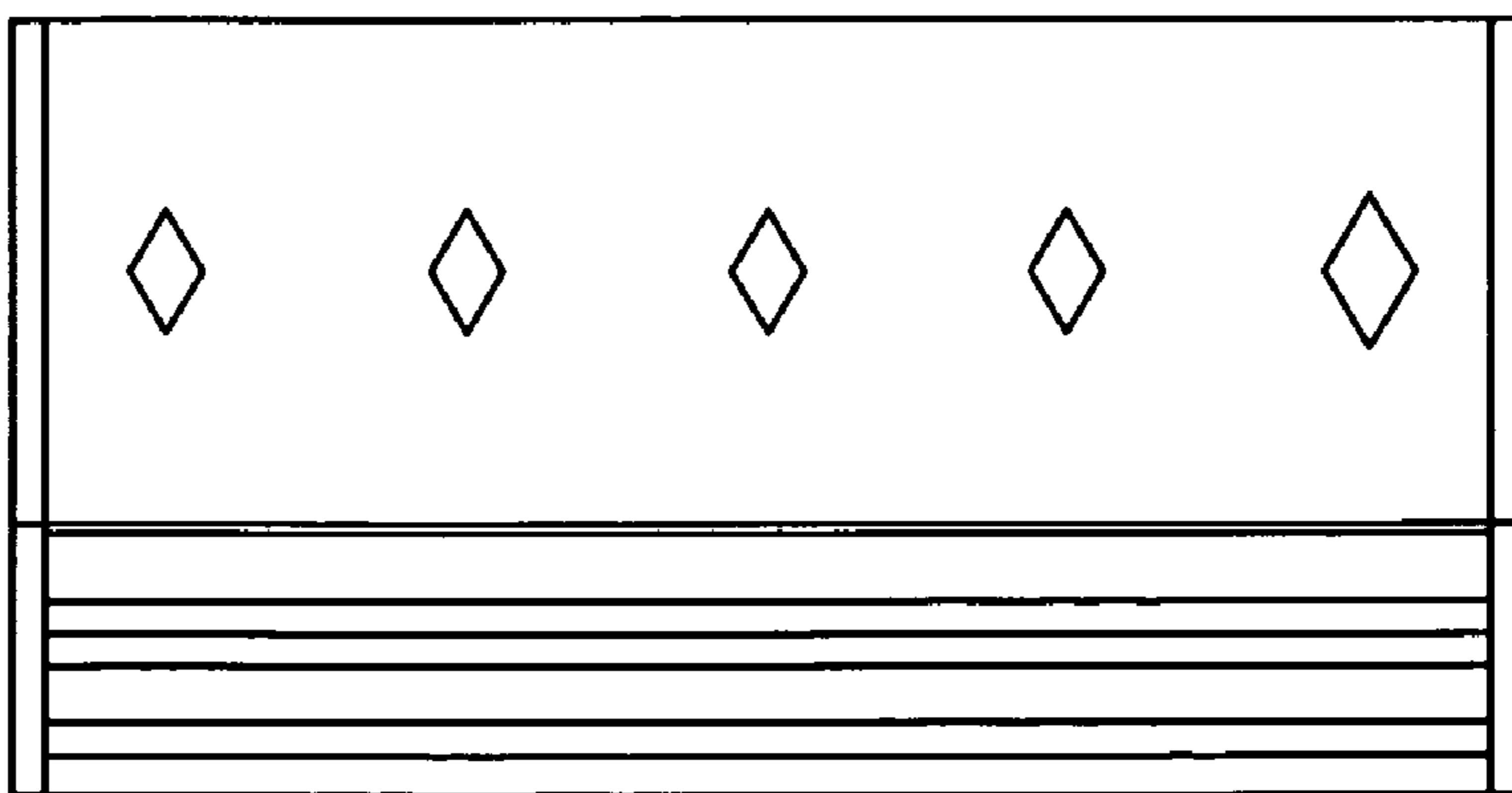

Fig.15

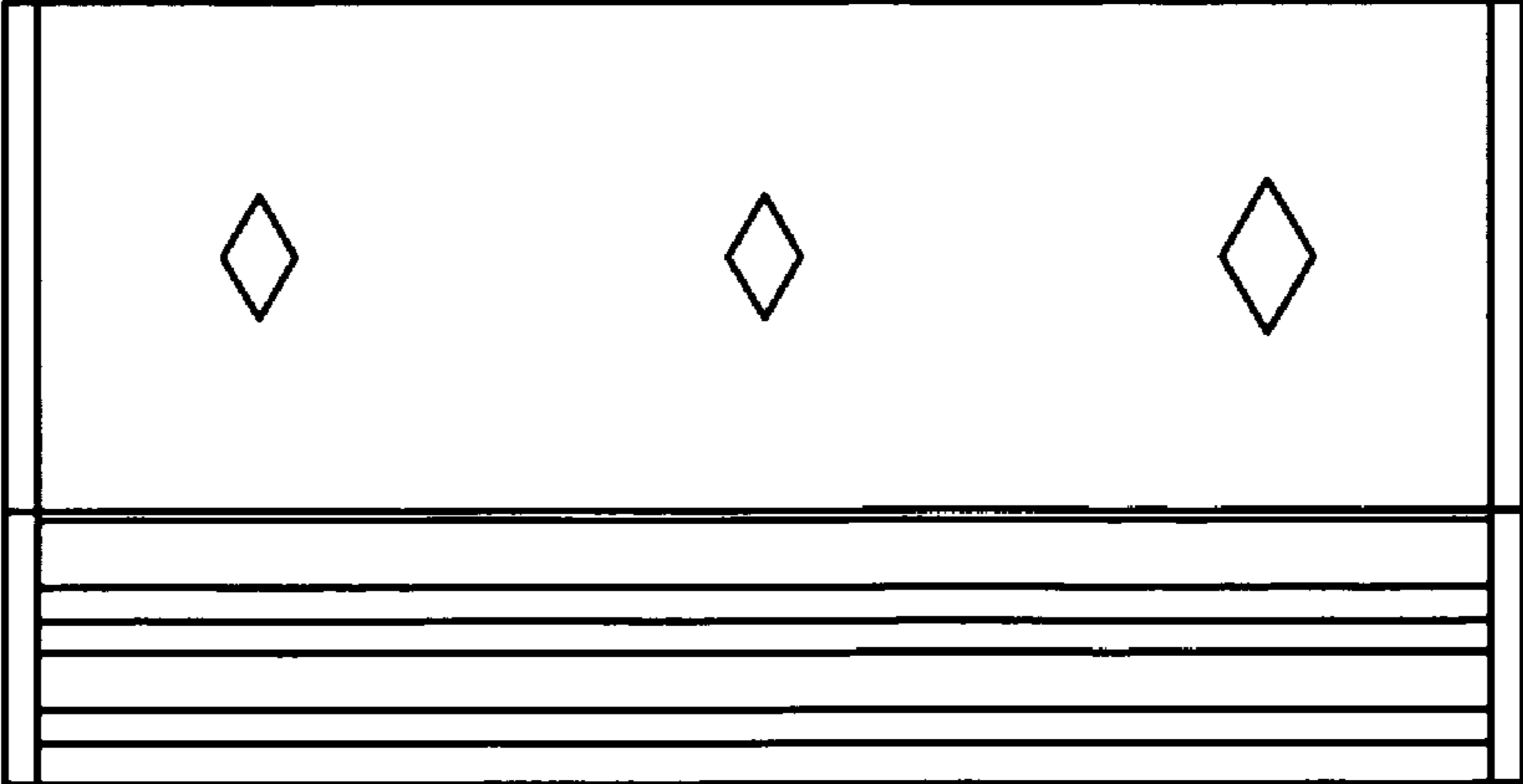

Fig.16

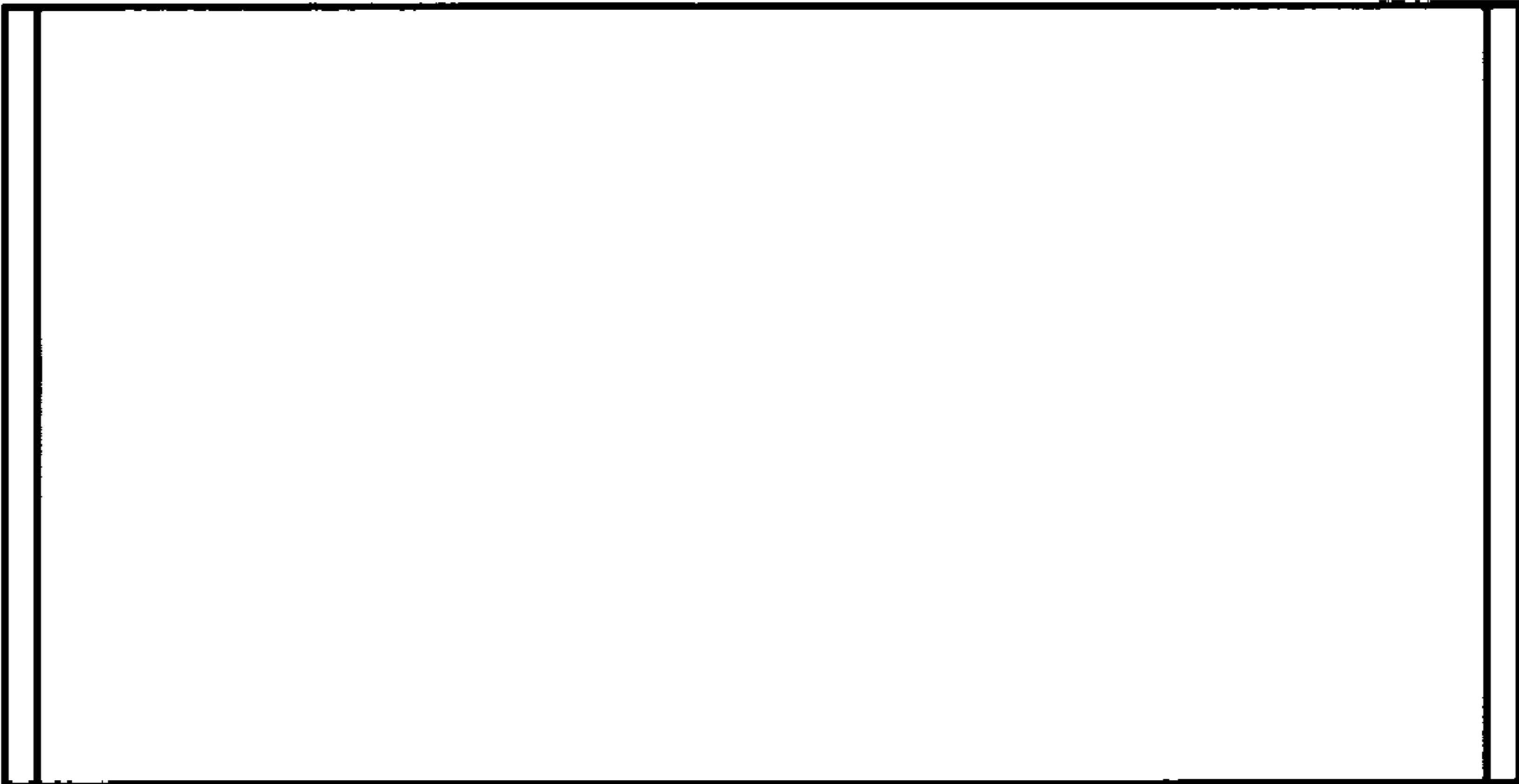

Fig.17

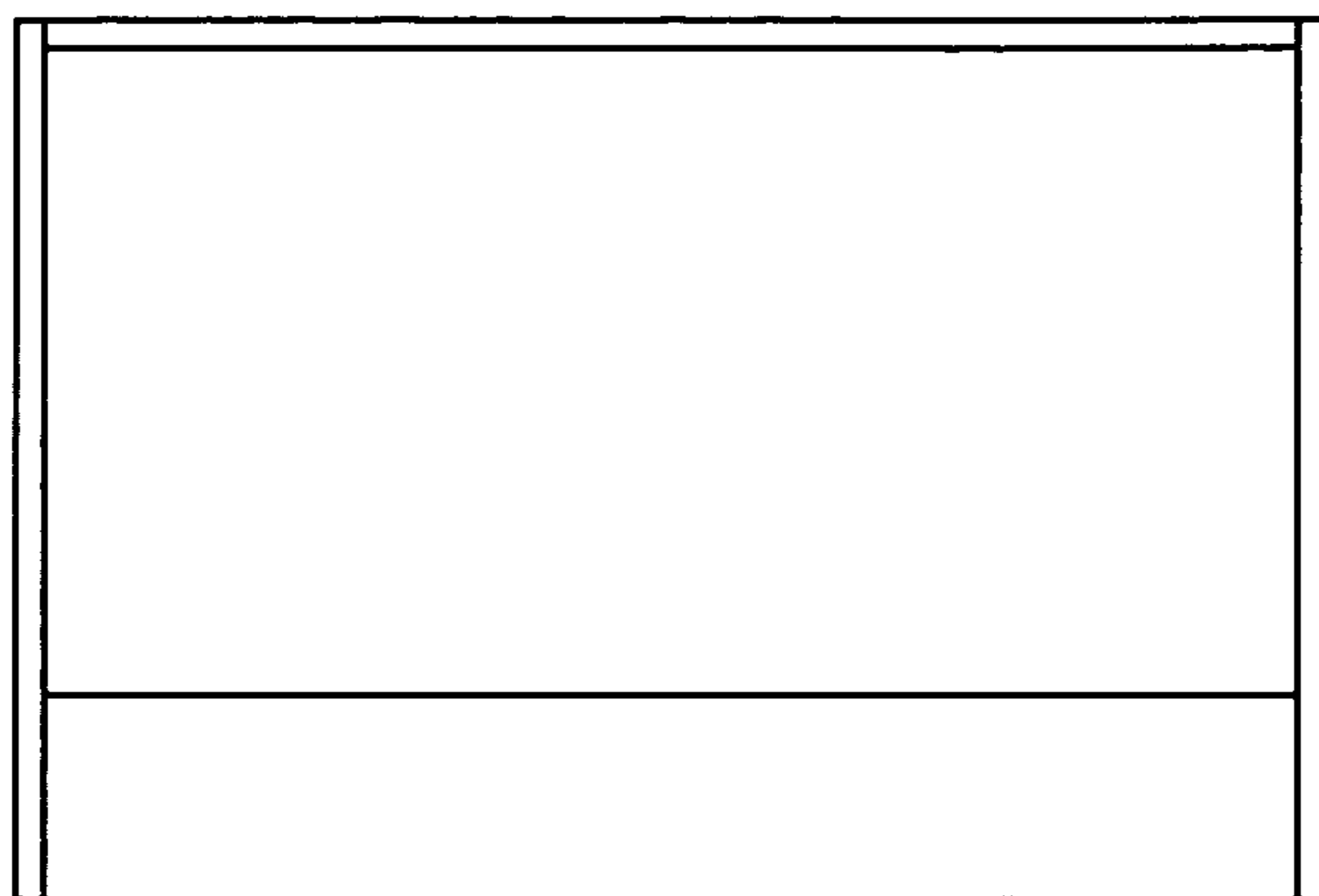

Fig.18

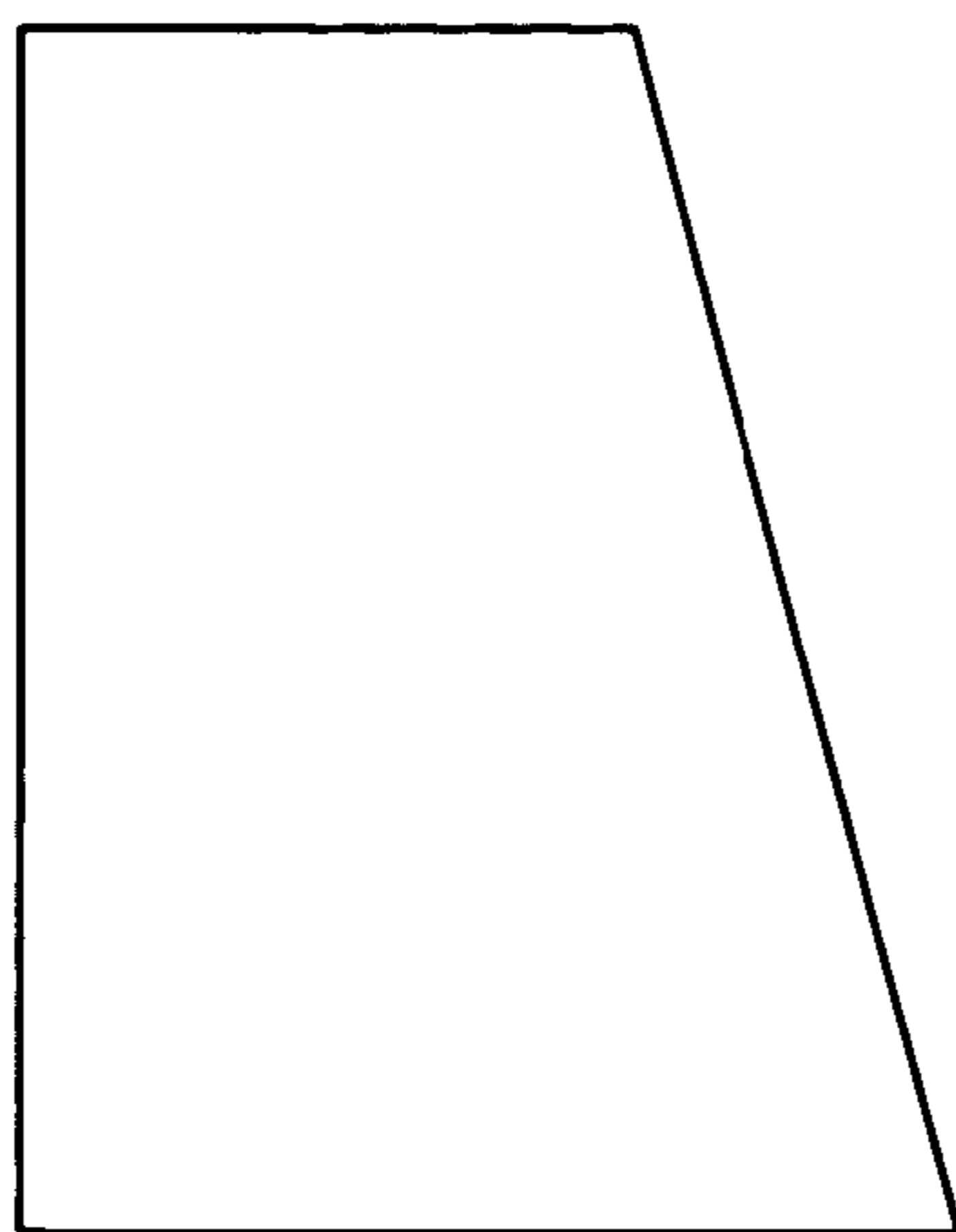

Fig.19

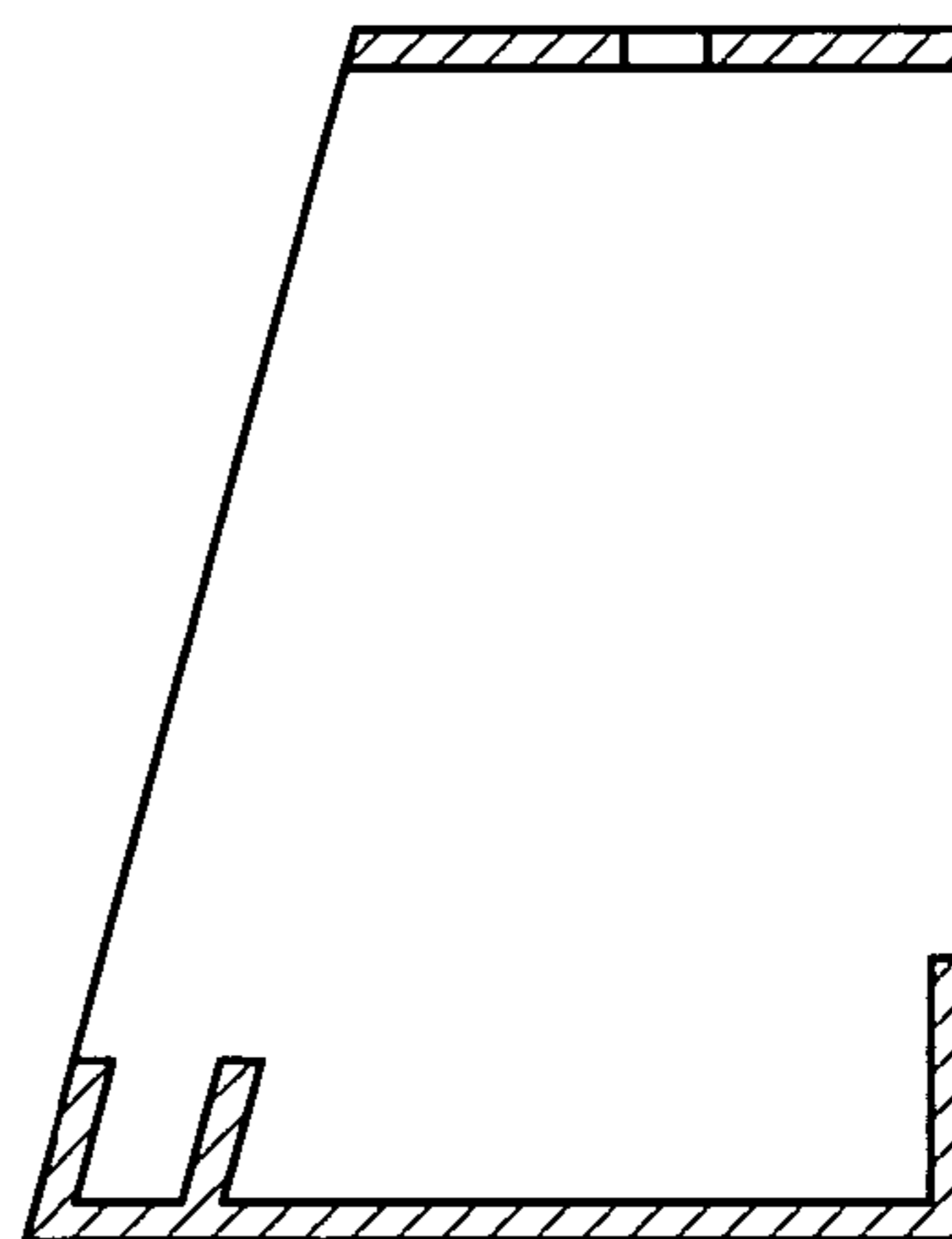

Fig.20

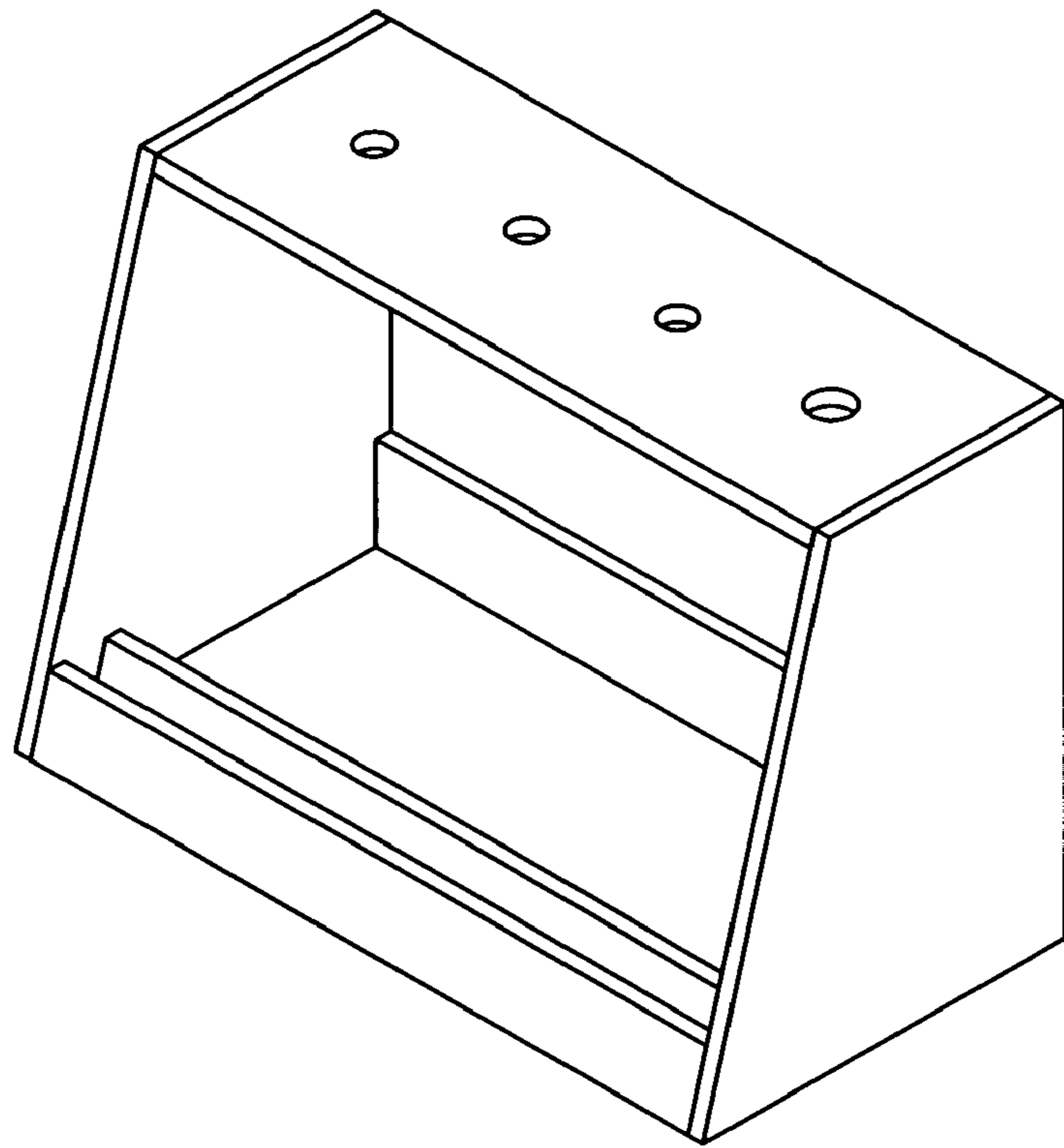

Fig.21

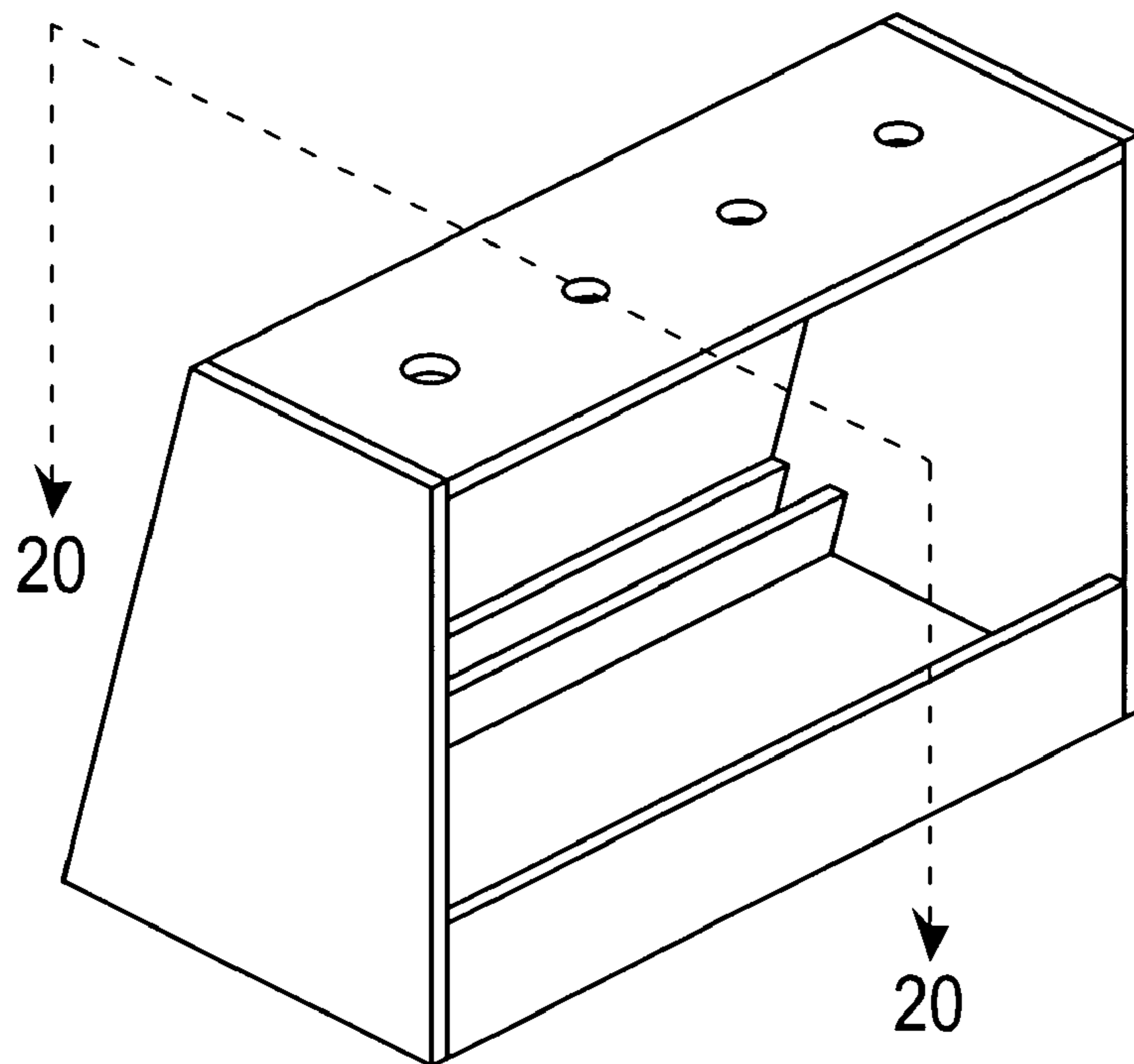

Fig.22

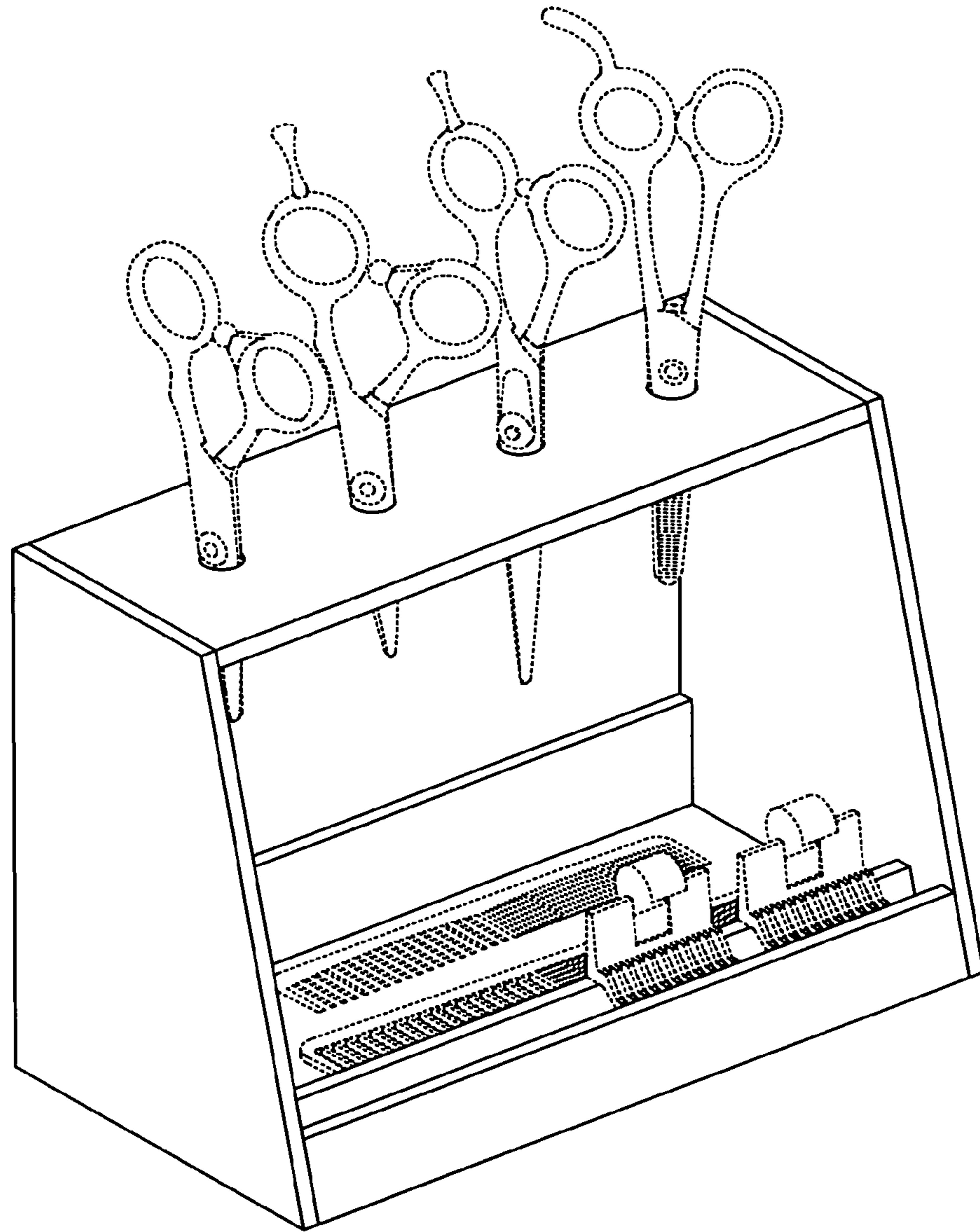

Fig.23